



Cornell University Library

BOUGHT WITH THE INCOME
FROM THE
SAGE ENDOWMENT FUND
THE GIFT OF
Henry W. Sage
1891

A. 291134

11/21/14

CORNELL UNIVERSITY LIBRARY



3 1924 088 434 463



Cornell University Library

The original of this book is in
the Cornell University Library.

There are no known copyright restrictions in
the United States on the use of the text.

The Victoria History of the
Counties of England

EDITED BY WILLIAM PAGE, F.S.A.

A HISTORY OF
HERTFORDSHIRE

VOLUME IV

THE
VICTORIA HISTORY
OF THE COUNTIES
OF ENGLAND

HERTFORDSHIRE



LONDON
CONSTABLE AND COMPANY LIMITED

A 291139

*This History is issued to Subscribers only by
Constable & Company Limited
and printed by W. H. Smith & Son
London*

INSCRIBED
TO THE MEMORY OF
HER LATE MAJESTY
QUEEN VICTORIA
WHO GRACIOUSLY GAVE
THE TITLE TO AND
ACCEPTED THE
DEDICATION OF
THIS HISTORY

Meesden Church, Herts.

Tile paving in Chancel (c. 1300)

A. WHITFORD ASHBRIDGE, A.R.I.B.A.

Mens. et deli. Sept. 1911

Scale of Feet

(Space under Table not tiled)



THE
VICTORIA HISTORY
OF THE COUNTY OF
HERTFORD

EDITED BY
WILLIAM PAGE, F.S.A.

VOLUME FOUR



LONDON

CONSTABLE AND COMPANY LIMITED

1914
5

CONTENTS OF VOLUME FOUR

	PAGE
Dedication	v
Contents	ix
List of Illustrations	xiii
List of Maps	xvi
Editorial Note	xvii
Topography	General descriptions and manorial descents compiled under the superintendence of WILLIAM PAGE, F.S.A.; Architectural descriptions by A. WHITFORD ANDERSON, A.R.I.B.A.; Héraldic drawings and blazon by the Rev. E. E. DORLING, M.A., F.S.A.; Charities from information supplied by J. W. OWSLEY, I.S.O., late Official Trustee of Charitable Funds
Edwinstree Hundred—	
Introduction	By ALICE RAVEN 1
Albury	By MAUD F. EDWARDS, Oxford Honours School of Modern History 4
Anstey	By HELEN DOUGLAS-IRVINE, M.A. 11
Aspenden <i>alias</i> Aspeden with Wakeley	By MAUD F. EDWARDS 17
Barkway	By LILIAN J. REDSTONE, B.A. 25
Barley	" " " " 36
Buckland	" " " " 42
Little Hadham	By MAUD F. EDWARDS and ALICE RAVEN 49
Much Hadham	" " " " " 58
Great Hornead	By ELEANOR J. B. REID, B.A. 68
Little Hornead	" " " " 74
Layston	By MAUD F. EDWARDS 77
Meesden	By ALICE RAVEN 88
Brent Pelham	By HELEN DOUGLAS-IRVINE, M.A. 91
Furneux Pelham	" " " " 100
Stocking Pelham	" " " " 108
Throcking	By MAUD F. EDWARDS 111
Wyddial	" " " " 114
Celtic and Romano-British Hertfordshire	By WILLIAM PAGE, F.S.A. 119
Topographical Index of Romano-British Remains	By M. V. TAYLOR, M.A., Oxford Honours School of Modern History 147
Social and Economic History	By A. F. H. NIEMEYER, Oxford Honours School of Modern History 173
Table of Population 1801-1901	By G. S. MINCHIN 233
Industries—	
Introduction	By C. H. VELLACOTT, B.A. 239
Textiles	By L. F. SALZMANN, B.A., F.S.A. 248

CONTENTS OF VOLUME FOUR

	PAGE
Industries (<i>continued</i>)—	
The Straw Plait, Hat and Bonnet Industry	By ETHEL M. HEWITT 251
Paper-making	By LEWIS EVANS, J.P., F.S.A. 256
Printing	By H. R. PLOMER 258
Pottery, Tiles and Bricks	By L. F. SALZMANN, B.A., F.S.A. 264
Plaster Work	By J. MURRAY KENDALL, F.S.A. 266
Bell Founding	By H. B. WALTERS, M.A., F.S.A. 268
Water-cress Growing	By G. EBSWORTH BULLEN 272
Forestry	By the Rev. J. C. COX, LL.D., F.S.A. 275
Ecclesiastical History—	
Before the Conquest	By WILLIAM PAGE, F.S.A. 281
After the Conquest	By HENRIETTA L. E. GARRETT 294
Religious Houses—	
Introduction	By MINNIE REDDAN, Hist. Tripos 365
Abbey of St. Albans—	
Before the Conquest	By WILLIAM PAGE, F.S.A. 367
After the Conquest	By MINNIE REDDAN, Hist. Tripos, with the assistance of notes supplied by NOWELL SIEVERS, B.A. 372
Priory of Redbourn	By MINNIE REDDAN, Hist. Tripos 416
" " Hertford	" " " " 419
" " Salburn in Standon	" " " " 421
" " Sopwell	" " " " 422
" " Cheshunt	" " " " 426
" " St. Mary de Pré, St. Albans	" " " " 428
" " St. Giles in the Wood, Flamstead	" " " " 432
" " Rowney, Great Munden	" " " " 434
" " Royston	" " " " 436
" " Wymondley	" " " " 440
" " New Bigging, Hitchin.	" " " " 443
Preceptory of Standon	" " " " 444
" " Temple Dinsley	" " " " 445
Priory of King's Langley	" " " " 446
Friars Minor of Ware	" " " " 451
Carmelite Friars of Hitchin	" " " " 451
Trinitarian Friars of Hertford	" " " " 452
College of Thele or Stanstead St. Margaret's	" " " " 454
Priory of Ware	" " " " 455
Hospital of St. Mary Bigging, Anstey	" " " " 457
Hospital of St. John Baptist, Berkhamstead	" " " " 458
Hospital of St. John the Evangelist, Berkhamstead	" " " " 459
Hospital of St. Erasmus and St. Mary Magdalene, Cheshunt	" " " " 460
Hospital of St. Mary Magdalene, Clothall	" " " " 460

CONTENTS OF VOLUME FOUR

	PAGE
Religious Houses (<i>continued</i>)—	
Hospital of St. Laud and St. Anthony, Hoddesdon	461
By MINNIE REDDAN, Hist. Tripos	461
Hospital of St. John and St. James, Royston	462
" " " "	462
Hospital of St. Nicholas, Royston	464
" " St. Julian by St. Albans	464

LIST OF ILLUSTRATIONS

	PAGE
Tile Paving in Meesden Church. By A. WHITFORD ANDERSON, A.R.I.B.A.	<i>coloured frontispiece</i>
Topography—	
Albury : Half-timbered House adjoining the Churchyard }	<i>full-page plate, facing</i> 6
„ Church : Late 14th-century Monument }	
„ „ East End of the South Aisle	9
Anstey : Lychgate to Churchyard	11
„ Church from the South-east }	<i>full-page plate, facing</i> 12
„ „ The Nave looking East }	
„ „ 12th-century Font	14
„ „ Plan	15
„ „ The Chancel }	<i>full-page plate, facing</i> 16
Aspenden Church : The Chancel }	
„ Hall : Garden Front	18
„ Church : Plan	23
„ „ from the North-east	24
Barkway : South End of Main Street	26
„ Village from the South }	<i>full-page plate, facing</i> 28
„ Old House in High Street }	
„ Church : The North Arcade	32
„ Manor House from the South-east }	34
Barley : The Town House from the South-west }	
„ The Big House, Staircase Wing }	38
„ Church from the West }	
„ The Fox and Hounds Inn }	42
Buckland Church from the South-East }	
„ „ Plan	46
„ „ South-east Corner of Nave, showing Junction of 14th and 15th-century Work	47
Little Hadham, Clintons, Bury Green	50
„ „ „ „ „ Roof Spandrel in Bedroom }	<i>full-page plate, facing</i> 52
„ „ Hadham Hall, Principal Front }	
„ „ „ „ Plan	<i>facing</i> 54
„ „ Church : Plan	56
„ „ 17th-century House, now Cottages, at Hadham Ford }	<i>full-page plate, facing</i> 56
„ „ Church : The Chancel }	
„ „ „ The Porch	57
„ „ 17th-century Cottage at the Foot of Ford Hill }	<i>full-page plate, facing</i> 58
Much Hadham Church : North Side of Chancel }	
„ The Lordship Stables	59
„ Yew Tree Farm	60
„ Buckler's Farm, Perry Green	61
„ „ The Palace from the South-east }	<i>full-page plate, facing</i> 62
„ „ Church : The North Arcade }	
„ „ „ Plan	64

LIST OF ILLUSTRATIONS

	PAGE
Topography (<i>continued</i>)—	
Much Hadham Church : 15th-century Chair	66
Great Hormead : Cottage East of Vicarage	68
" " 16th-century House	<i>full-page plate, facing</i> 68
" " Hare Street House	69
" " Brick House : Plan	70
" " " "	70
" " Bury : Entrance Front	71
" " Church from the North-east }	<i>full-page plate, facing</i> 72
" " " The South Arcade }	
" " Hormead Hall from the South-west	73
Little Hormead Church from the South-west }	<i>full-page plate, facing</i> 74
" " " The Chancel Arch }	
" " " Plan	76
" " " Blocked North Doorway	<i>full-page plate, facing</i> 76
Layston Church from the South-east	78
" Buntingford, Ward's Hospital from the East	79
" " The Court, originally the Grammar School }	<i>full-page plate, facing</i> 80
" " View in the High Street }	
" Alswick Hall : Plan	81
" " " from the South-east	83
" Church : Plan	85
" " The Chancel from the Nave	86
" St. Peter's Chapel, Buntingford, from the South-west (before 1899)	87
" Church : The Font }	<i>full-page plate, facing</i> 88
Meesden Church : The South Porch }	
Brent Pelham : The Beeches, Plan	92
" " " Ceiling of Parlour	93
" " The Stocks	94
" " Hall, West Front	95
" " The Beeches, South-west Front	96
" " Church : The South Door	98
" " " Shonks's Tomb	99
Furneux Pelham Hall : Plan	100
" " " from the South-west }	<i>full-page plate, facing</i> 102
" " Church : 13th-century Piscina and Sedilia }	
" " " The Nave Roof }	" " " 104
" " " Fragment of Oak Screen }	
" " " from the South-west	105
" " " Roof of the South Chapel	106
Stocking Pelham Church from the South-east	109
" " " Plan	110
Throcking Church : Plan	113
" " from the South-east }	<i>full-page plate, facing</i> 114
Wyddial Church from the North-east }	
" " The Chancel Arch and North Arcade }	" " " 116
" " The North Aisle looking East }	
Celtic and Romano-British Hertfordshire :	
Verulamium : Top of Late Celtic Sword	119

LIST OF ILLUSTRATIONS

	PAGE
Celtic and Romano-British Hertfordshire (<i>continued</i>)—	
Verulamium : Late Celtic Bronze Helmet	
Northchurch : Late Celtic Bronze Helmet found at Northcott Hill	} <i>full-page plate, facing</i> 122
Verulamium and Welwyn, Romano-British Pottery in the Herts County Museum	" " " 126
Romano-British and Gaulish Pottery in the Herts County Museum	" " " 128
Circular Base of a Column : Plan	131
Verulamium : Plan of Supposed Forum facing 132
St. Albans: Glass Jug from Worley Road, in the Herts County Museum	} <i>full-page plate, facing</i> 134
Romano-British Red Ware, in the Herts County Museum	
Verulamium : Plan of Theatre facing 136
Roman Brick Grave found in Verulam Hill Field	137
Verulamium : Romano-British Pots, forming an Interment at St. Michael's, in the Herts County Museum <i>full-page plate, facing</i> 138
Welwyn : Pair of Silver Vases and Three Bronze Masks	" " " 140
Braughing : Map showing Roman Remains	141
Romano-British Black Ware in the Herts County Museum <i>full-page plate, facing</i> 142
Barkway : Bronze Figure of Mars and Silver Plates with Inscriptions, in the British Museum	" " " 148
Braughing : Bronze Brooch	
" " Enamelled Cup	} " " " 150
Verulamium : Bronze and Iron Objects in the Herts County Museum	
Hemel Hempstead : Tessellated Pavement at Boxmoor Villa	" " " 152
" " Plan of Boxmoor Villa	154
" " Roman Antiquities found in a Villa at Boxmoor, Plate xiii <i>full-page plate, facing</i> 154
" " Roman Antiquities found in a Villa at Boxmoor, Plate xiv	" " " 156
Radlett : Pottery from Romano-British Kilns	158
" Plan and Section of Roman Potter's Kiln	160
" Mortarium from Kiln	
" Fragments of Mortaria showing Method of Packing in Kilns	} <i>full-page plate, facing</i> 160
" Plan and Section of a Potter's Kiln	161
" Roman Potter's Kiln	162
" Potter's Stamps of Castus found in a Kiln	162
" " Marks found in a Kiln	162
Sarratt : Plan of Roman Building	163
Welwyn : Models of Fire-dogs and Iron Frame <i>full-page plate, facing</i> 164
" Late Celtic Bronze Patella	166
" " Cinerary Urns and Tazza <i>full-page plate, facing</i> 166
" " Antiquities	167
" " Pottery <i>full-page plate, facing</i> 168
Great Wymondley : Plan of Roman Holding	170
" " " " " Villa near Purwell Mill <i>full-page plate, facing</i> 170
Industries—	
Watermark of John Tate	256
Stamp of Robert Oldfield	270
Religious Houses—	
Hertfordshire Monastic Seats : Plate I <i>full-page plate, facing</i> 416
" " " Plate II	" " " 434

LIST OF MAPS

	PAGE
Index Map to the Hundred of Edwinstree	1
Roman Map	<i>· facing</i> 119
Ecclesiastical Map	<i>· ”</i> 365

EDITORIAL NOTE

THE Editor desires to acknowledge his obligations to the following, who by reading the proofs of this volume have added much to the accuracy of the work :—The Rt. Hon. Sir Robert Romer, G.C.B., Mr. Edward E. Barclay, M.A., J.P., the Rev. C. V. Bicknell, the Rev. F. R. Broughton, M.A., the Rev. Henry F. Burnaby, M.A., the Rev. J. M. Bury, B.A., Mr. F. A. Crallan, Messrs. Crossman, Prichard & Co., the Rev. J. L. Dutton, M.A., the Rev. F. H. Francis, M.A., Mrs. Gregory, the Rev. H. B. Grindle, Prof. F. Haverfield, LL.D., F.S.A., the Rev. A. Howard, M.A., Mr. W. Minet, M.A., F.S.A., J.P., Mr. J. Horace Round, M.A., LL.D., the Rev. C. H. Spurrell, M.A., the Rev. W. T. Stubbs, M.A., the Rev. J. L. P. Thomas, M.A., the Rev. J. Frome Wilkinson, M.A., F.S.A., the Rev. F. R. Williams, M.A., and Mr. Horace Wilmer, M.I.C.E., F.S.A.

For illustrations and plans, with permission to reproduce them, the Editor is indebted to :—the Society of Antiquaries, the Hertfordshire Natural History Society, Messrs. Longmans, Green & Co., Mr. William Ransom, F.L.S., F.S.A., the St. Albans and Hertfordshire Architectural and Archæological Society, Mr. Hugh Seebohm, and Mr. G. A. Wright (Curator of the Corporation Museum, Colchester).

The manorial descents of the Hundred of Edwinstree have been compiled under the supervision of Miss Alice Raven, and the drawings for the line blocks have been made by Miss Jenny Wylie, Mr. Whitford Anderson, A.R.I.B.A., Mr. Laurence Davies and others.

A HISTORY OF
HERTFORDSHIRE

TOPOGRAPHY

THE HUNDRED OF EDWINSTREE

CONTAINING THE PARISHES OF

ALBURY	LITTLE HADHAM	BRENT PELHAM
ANSTEY	MUCH HADHAM	FURNEUX PELHAM
ASPENDEN WITH WAKELEY	GREAT HORMEAD	STOCKING PELHAM
BARKWAY	LITTLE HORMEAD	THROCKING
BARLEY	LAYSTON	WYDDIAL ¹
BUCKLAND	MEESDEN	

The hundred of Edwinstree occupies the north-eastern corner of Hertfordshire and borders on the county of Essex. The parishes on the eastern side, where the two counties adjoin, seem to have been still in part thickly covered with woodland in the 11th century.² Probably the early settlements here were sparse, and this would account for the subdivision of areas suggested by the names Brent Pelham, Furneux Pelham, and Stocking Pelham and Much and Little Hadham. In the 13th century there was still a large amount of woodland in these parishes.

The total assessment of the hundred in 1086 seems to have been for 120 hides. The exact amount, however, is difficult to estimate, owing to the doubt that arises about the inclusion of several places within it.³ Widford, which is entered under Edwinstree in 1086 but is now a parish in Braughing Hundred, lies on the border of Edwinstree Hundred, and there is no reason why it should not have been included in it in 1086. Cockhamstead also, an estate in the parish of Braughing, adjoins the parish of Albury in this hundred and may have been originally reckoned within it. An estate in Hoddesdon, however, which is given under Edwinstree in 1086, can scarcely be entered correctly under that hundred, as it is separated from it by the hundred of Braughing, and the other holdings there are given under Hertford Hundred. On the other hand an estate of 5 hides in Ansteay is entered under Odsey Hundred, but, as Ansteay does not adjoin Odsey Hundred and another holding there is

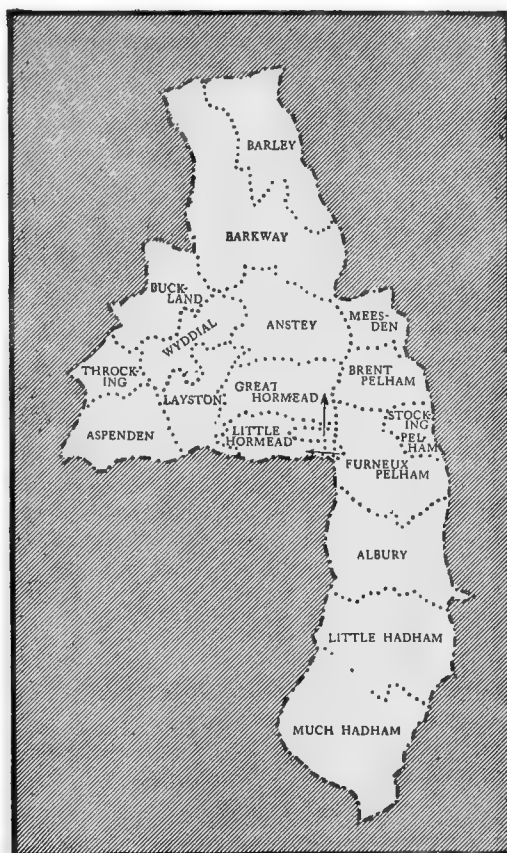

INDEX MAP TO THE HUNDRED OF EDWINSTREE

¹ *Pop. Ret.* (1831), i, 246.

² In the small parish of Meesden the return of woodland was for 400 swine in 1086 (*V.C.H. Herts.* i, 307b).

³ The total amount at which Barkway was assessed is also a little uncertain (*V.C.H. Herts.* i, 329, n. 1).

A HISTORY OF HERTFORDSHIRE

returned under Edwinstree, it is probable that this is due to the omission of a heading. With these exceptions the area has remained unchanged since 1086.

Within the hundred there has been to some extent a change of composition. Layston is not mentioned in the Domesday Survey, but is evidently represented by Alfladewyk. In the Subsidy Rolls of the 13th and 14th centuries it is noticeable that Layston and Alfladewyk do not occur on the same Roll,⁴ and 'the parish of Lestanchurch called Alfladewyk' was assessed for a ninth in 1340.⁵ It seems probable, therefore, that after 'le stan church' was built and Alfladewyk became an ecclesiastical parish, Lestanchurch or Layston gradually superseded Alfladewyk as the parochial name. In the 12th century the church of Alswick acknowledged itself a chapel to this church and Alswick was thenceforward included within the ecclesiastical parish of Layston, but as a civil parish it remained separate for purposes of taxation as late as the 16th century. Wakeley is another ancient parish which has failed to maintain its entity. In 1307 three persons were assessed there for a lay subsidy⁷; at the levy of the ecclesiastical subsidy in 1428 a return of 'no inhabitants' was made.⁸ It was taxed separately as late as the 17th century, although only one resident was assessed for the hearth tax.⁹ Berkesden was an ancient ecclesiastical parish, but apparently had no separate civil existence. In the 13th century Bordesden and Patmore (both of which are mentioned in the Domesday Survey) appear as townships with judicial responsibilities,¹⁰ and in 1307 a subsidy was charged on 'Little Hormead and Bordesden.'¹¹ There is no evidence, however, that either of these ever formed a separate parish. There are none of the small boroughs in this hundred which are common in Braughing, but by the beginning of the 14th century the road settlements of Barkway on the Cambridge road and Much Hadham on the route from Essex into the south of Hertfordshire are found considerably in advance of the other parishes in size of population.¹² Next to these in 1307 come Albury, Anstey and Barley, whilst Buckland on Ermine Street stands considerably lower. In 1545 Barkway was by far the richest township in the hundred.¹³

The subdivision of holdings in this hundred before the Conquest is very noticeable. With the exception of the estates of the Bishop of London and the church of Ely at Hadham and of the abbey of Chatteris at Barley, nearly every parish seems to have been divided into small holdings held by the men or sokemen of the king, Earl Harold, Earl Algar, Archbishop Stigand, Asgar the Staller, Anschil of Ware, Godwin of Benefel, Almar of Belintone and others.¹⁴ After the Conquest these

⁴ cf. Lay Subs. R. bdle. 120, no. 5 (24 Edw. I), where Lestanchurch is given, but not Alfladewyk; bdle. 120, no. 7 (34 Edw. I), where Alfladewyk is assessed; and bdle. 120, no. 8 (1 Edw. II), where Alfladewyk is given again, Layston not being mentioned in the two latter rolls. See also Assize R. 318 (32 Hen. III), where there is an entry concerning the drowning of a certain Elena near 'Lestoneschurch.' Her brother, the first finder, did not appear, and was attached by Hugh the Clerk of Alfladewyk.

⁵ *Inq. Nonarum* (Rec. Com.), 432; see Assize R. 325 (15 Edw. I), m. 7, where the parish of Alfladewyk is mentioned.

⁶ Lay Subs. R. bdle. 120, no. 120 (16 Hen. VIII).

⁷ *Ibid.* no. 8.

⁸ *Feud. Aids*, ii, 457.

⁹ Lay Subs. R. bdle. 248, no. 29.

¹⁰ Assize R. 323.

¹¹ Lay Subs. R. bdle. 120, no. 8 (1 Edw. II)

¹² *Ibid.* no. 7, 8.

¹³ See Subsidy Roll printed in *Herts. Gen. and Antiq.* i, 163.

¹⁴ In connexion with these holdings of sokemen the occurrence in three cases of the suffix 'wick' preceded by a personal name is interesting. Lewarewick had been held T. R. E. by Leware, Alswick is evidently a contraction of Alsuswick, and Alfladewyk probably took its name from an Æthelfaeda.

EDWINSTREE HUNDRED

fractional holdings had to a great extent been amalgamated into larger estates, but even in 1086 the holdings are comparatively small and numerous, one 'manor' at Wakeley consisting of 40 acres, another estate at Throcking of 12 acres, whilst a hide at 'Haslehangra' was divided into two thirds and a third.

In the 13th century the hundred court still met on a plot of ground called 'Edwynestre, which was held by the sheriff and was worth 1*d.* per annum.¹⁵ Unfortunately, there is no direct evidence as to where this plot was situated. At the same date, however, there is mention of 'the wood of Edwynesbrugg, and as the villis of Furneux Pelham and Brent Pelham were presented for not making suit in connexion with a murder in this wood,¹⁶ it seems probable that Edwinsbridge was in their neighbourhood and perhaps also Edwin's Tree.

The hundred of Edwinstree was farmed by the sheriff with that of Odsey.¹⁷ It remained vested in the Crown until 1613, when it was granted with the hundred of Odsey to William Whitmore and others¹⁸ in trust for Sir Julius Adelmare *alias* Caesar. It then followed the descent of Odsey.¹⁹ The chief private franchise within the hundred was that of the Bishop of London, who owned either in demesne or in overlordship a great part of the land within its area. With Much Hadham, a pre-Conquest possession of the bishopric, where perhaps already at that date the bishops had a residence, as a nucleus, these lands were acquired by the bishopric before 1086, and with a few other places in Braughing Hundred formed a barony of which Bishop's Stortford in that hundred was the head. By virtue of the extensive liberties enjoyed by the bishopric throughout its lands, the see at one time claimed a right to half the hundred of Edwinstree.²⁰ This, however, it did not attempt to make good before the justices of Edward I, but claimed quittance of suit of hundred court for its men and their tenants and assize of bread and ale and gallows at Hadham.²¹ In 1275 it was presented that the bishop's bailiffs would not allow the king's ministers to enter the bishop's liberty in the 'vale of Hadham' to distrain for the king's debts.²² At the same date the Bishop of Ely claimed return of writs, gallows and tumbrel in Little Hadham.²³ Gallows and assize of bread and ale were claimed by the Bishop of Bath and Wells at Newsells and Barkway, by the Abbot of Colchester at Barley, by the Earl of Gloucester at Popeshall, by Denise de Monchensey at Anstey, and by Lora de Sanford at Hormead.²⁴ The jurors for the hundred also deposed 'withdrawals' made by the Abbots of Colchester and Chatteris, whose tenants had formerly come by two men to the sheriff's tourn twice a year, and by the lord of Popeshall, who had withdrawn his suit from two 'general county courts' and had kept back 5*s.* for sheriff's aid and 2*s.* for fines of default (*sursisa*). A similar presentment was made for Andrew le Guys, who held of Geoffrey de Scales.²⁵

¹⁵ Assize R. 313 (6 & 7 Edw. I), m. 46.

¹⁶ Ibid. m. 44.

¹⁷ Ibid. 323, m. 46; *Hund. R.* (Rec. Com.), 193.

¹⁸ Pat. 10 Jas. I, pt. xxi, no. 7.

¹⁹ See Recov. R. East. 15 Chas. II, rot. 135; 39 Geo. III, rot. 33.

²⁰ *Plac. de Quo Warr.* (Rec. Com.), 290; Assize R. 325, m. 7.

²¹ *Plac. de Quo Warr.* (Rec. Com.), 290; Assize R. 323, m. 46. The bishop's view of frankpledge was held at Patmore (Surv. of Albury, MSS. at St. Paul's, WD. 16, Liber I).

²² *Hund. R.* (Rec. Com.), 193.

²³ Ibid.

²⁴ Assize R. 323, m. 46.

²⁵ *Hund. R.* (Rec. Com.), 193.

A HISTORY OF HERTFORDSHIRE

ALBURY

Eldeberie (xi cent.); Audeburia (xiii cent.); Aldehuri, Aldebery (xiv cent.).

The parish of Albury contains 3,248 acres, of which over 2,000 are arable and about one-quarter permanent grass.¹ The district is fairly well wooded, the more important woods being Patmore Hall Wood in the north of the parish, Bog's Wood, Shaw Wood, Upwick Wood and Salmon Mead Spring in the east, Albury End Wood and Burrell's Spring in the south, Ferrick's Wood in the west, and Ninno Wood which lies along the Ash in the centre of the parish. This part of the river appears to have been known as Ninno Water in the 17th century.² The Ash flows through the middle of the parish, and the land rises from 251 ft. above the ordnance datum in the valley to about 374 ft. in the east and to over 400 ft. in the west. An inclosure award for Albury was made in 1869 under an Act of 1864.³

Among the place-names in the parish were Chisley Field Common, Ann's Common, Mill Field Common, Patmore Field, Clapgate Common, Parsonage Field, Great Bushey Ley, Molly's Chip.⁴ In the south of the parish are two greens, Upwick Green and Walnut Tree Green.

The parish is bordered on the east by the boundary between Essex and Hertfordshire, and on the south by the Stane Street.

The village lies nearly a mile to the north of Stane Street, the church of St. Mary standing on high ground on its north side. The manor-house of Albury Hall stands in a park of 200 acres about half a mile to the north-west. It was built by John Calvert at the end of the 18th century about 80 yards north of the site of the original hall which he had pulled down. The west wing was added by Richard Dawson in 1848.⁵ The house has been restored and enlarged by its present owner, Mr. M. G. Carr Glyn.

The present vicarage is a modern house built about 1847,⁶ on the south side of the village street. The Parsonage Farm lies further west on the north side of the road. Adjoining the churchyard is a 16th or possibly 15th-century half-timbered house, much altered in the last three centuries. It is a two-storied rectangular building with a thatched roof and is now divided into two cottages. There is some ancient brick-nogging in the east front and in the west gable is a 17th-century moulding in low relief; in the south front is some plaster work moulded in panels of about 1700.

Albury Lodge, which stands about three-quarters of a mile to the south-east of the church, was held in the 17th century by the Brograves,⁷ and was possibly built by them about 1597, when they acquired half the manor. It was built of timber, and during the 19th century was cased in brick. The plan of the house is E-shaped, with the main block facing east. On the west is a projecting staircase wing. Some of the rooms contain the original panelling reset, and there is a pilaster with arabesque panels on

the first floor. A small garden on the east is inclosed by a 17th-century wall with a moulded brick plinth.

In the middle of the last century the village was in a deplorable state. There was no resident clergyman, and the curate who rode over to take the services was accustomed, if he found only a few people assembled, to bribe them to go away. After the purchase of the Patmore Hall estate by Mr. Hugh Parnell in 1848 the condition of affairs was altered. The old vicarage to the west of the church, which was uninhabitable, was pulled down, and in 1849 a school was built by public subscription on its site.

Albury contains several small hamlets. Clapgate, where there is a smithy, lies at the junction of the village street with the Pelham road. In 1646-7 John Scroggs, lord of the manor of Patmore, complained that John Ginne of Albury had inclosed part of the common 'fayring way' between Clapgate and Albury Church near a water-course, so that the inhabitants were obliged to plunge into a pit whenever it rained if they wished to pass that way either to church or elsewhere.⁸ Gravesend is a hamlet on the Pelham road a little north of Clapgate. Albury End lies on a road leading south from the village to Stane Street. Upwick is in the south-east of the parish on the road to Farnham.

At Patmore Heath is a village built round the heath, on the east of which is a windmill. In 1683 several people were fined for attending an unlawful conventicle at Patmore Heath. The preacher was Thomas Burn, whose malt was seized by the constables, probably in default of the payment of a fine.⁹ There is now an unsectarian mission chapel here. Patmore Hall is now a farm. The present house was built in 1862. A part of the Elizabethan panelling from the old house, then pulled down, was found in a fowl-house in 1912 and removed to Carldane Court, Much Hadham, where it has been incorporated in a mantelpiece. Traces of a home-stead moat which remain in the garden suggest that the hall was once surrounded by a double moat. There seem to be remains of earthworks also to the south and south-east of the house.¹⁰

Upwick Hall lies a little over a mile to the south-east of the church. Most of the house is modern, but one of the doorways has an oak frame of Tudor date, and two of the ground floor rooms have 17th-century panelling. A stone on the east front of the house is marked with the date 1646 and the initials T. S., which probably refer to one of the Staceys. The gardener's cottage at Upwick Hall dates from the end of the 15th century and is part of an L-shaped building. It has an overhanging upper story. The walls are of plaster, timber-framed, and the lower story is weather-boarded. The red brick chimney stack has square shafts set diagonally and is a 17th-century addition. There are two large fireplace openings placed back to back and spanned with wooden lintels. The doorway on the north side,

¹ Statistics from Bd. of Agric. (1905).

² *Sess. R.* (Herts. Co. Rec.), i, 228.

³ Private Act, 26 & 27 Vict. cap.

⁴ Cussans, *Hist. of Herts. Edwinstree Hund.* 159.

⁵ *Ibid.*

⁶ *East Herts. Arch. Soc. Trans.* ii, 229.

⁷ See Chan. Inq. p. m. (Ser. 2), cccxcxi, 18.

⁸ *Sess. R.* (Herts. Co. Rec.), i, 89.

⁹ *Ibid.* 334, 343.

¹⁰ *East Herts. Arch. Soc. Trans.* ii, 238.

EDWINSTREE HUNDRED

ALBURY

now blocked, has a flat four-centred arch, and there is a similar arch in the partition inside. Two other doorways have flat Tudor arches of oak, similar to the one at the hall.

In the reign of Edward the Confessor *MANORS* the manor of *ALBURY* was held of Archbishop Stigand by Siward.¹¹ After the Conquest it was acquired by the Bishop of London¹² and became part of the barony of Stortford belonging to the Bishops of London, of whom it was held by knight service.¹³ At the end of the 13th century the bishop claimed that his tenants in Albury and his other villis in the hundred of Edwinstree should be quit of suit of hundred court as they had always been accustomed.¹⁴ The last record of any rights of overlordship found is in 1522.¹⁵

In 1086 a certain Ralf was tenant in fee of Albury Manor.¹⁶ It afterwards passed to the Baards. In 1166 William Baard held two knights' fees of the Bishop of London,¹⁷ which probably represent the manor of Albury, for at the beginning of the 13th century Simon Baard held two knights' fees which are located in Albury.¹⁸ In 1294 Albury was held by Robert Baard,¹⁹ who in 1316 settled the reversion of the manor on Geoffrey de la Lee and Denise his wife for their lives, with successive remainders to their sons Thomas, John and Robert.²⁰ The manor had descended to Geoffrey and Denise before March 1319-20, when Geoffrey de la Lee received a grant of free warren.²¹ There is no evidence that Thomas de la Lee ever held Albury, but by 1336 the manor had descended to John de la Lee, to whom Peter, vicar of Albury, and John de Vataille released the right of common in the park of Albury which his father Geoffrey de la Lee had granted them.²² John de la Lee received a grant of free warren in Albury and Braughing in 1366 with licence to inclose and impark 300 acres of land there.²³ He died seised of the manor in 1370, at which date there was a windmill on the manor worth 10s.²⁴ His son and successor Walter²⁵ had one son Thomas, who died without issue before his father. On Walter's death in 1395 his heirs were his three sisters, Margery, who married Robert Newport, Joan the wife of John Barley, and Alice the wife of Sir Thomas Morewell.²⁶

In 1396 Sir Thomas Morewell and Alice his wife

conveyed their share to the vicar of Albury and others, evidently in trust for John Barley and Joan



BISHOPRIC OF LONDON.
Gules two swords of St. Paul crossed saltirewise.

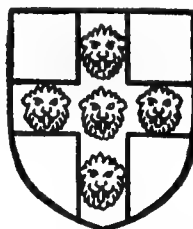

DE LA LEE. *Argent a cross azure with five leopards' heads or thereon.*

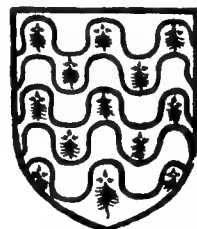

BARLEY. *Barry wavy sable and ermine.*

his wife, who held a court of the manor the same year.²⁷ Joan died in 1419 and her husband in 1420,²⁸ and Albury passed to their son John Barley.²⁹ He died seised of the manor in February 1445-6, when it descended to his son Henry Barley,³⁰ who held it until his death in January 1475-6.³¹ His son William Barley, who succeeded him, was concerned in Perkin Warbeck's conspiracy and forfeited his lands for high treason in 1495.³² The bill of attainder was reversed in 1498 and the lands restored in 1503,³³ and Barley died seised of Albury in March 1521-2.³⁴ It descended to his son and heir Henry Barley,³⁵ and on his death in 1529 to his son William Barley,³⁶ who died before 1563,³⁷ when the manor was held by his daughter Dorothy and her husband Thomas Leventhorpe.³⁸ Dorothy died in 1574³⁹ and her husband in 1588.⁴⁰ Their only son Thomas died without issue in 1594⁴¹ and Albury was divided among his four sisters.⁴² In 1594 Richard Frank, husband of Anne, one of the heirs, became possessed of half the manor by acquiring the share of Francis Hubberd and Elizabeth, another of the heirs,⁴³ and in 1597 John Brograve, father of Simeon Brograve, husband of Dorothy the third heir, bought the quarter of the manor which was held by John Longmer and Helen his wife, the fourth heir.⁴⁴ On John's death in 1613 this quarter descended to Simeon,⁴⁵ who thus with his wife Dorothy became possessed of the other half of the manor. The manor remained in these two families during the 17th century.



BROGRAVE. *Argent three leopards gules.*

¹¹ *V.C.H. Herts.* i, 306b.

¹² *Ibid.*

¹³ See *Red Bk. of Exch.* (Rolls Ser.), ii, 541; *Feud. Aids*, ii, 431; Chan. Inq. p.m. 44 Edw. III (1st nos.), no. 37; 15 Edw. IV, no. 37; (Ser. 2), xxxviii, 24.

¹⁴ *Plac. de Quo Warr.* (Rec. Com.), 290.

¹⁵ Chan. Inq. p.m. (Ser. 2), xxxviii, 24.

¹⁶ *V.C.H. Herts.* i, 306b.

¹⁷ *Red Bk. of Exch.* (Rolls Ser.), i, 186.

¹⁸ *Ibid.* ii, 541.

¹⁹ Lay Subs. R. bdle. 120, no. 8; see *Feud. Aids*, ii, 431.

²⁰ Feet of F. Herts. 9 Edw. II, no. 231.

²¹ *Cal. Chart. R.* 1300-26, p. 417.

²² Chauncy, *Hist. Antiq. of Herts.* 147 (quoting charter penes Sir T. Brograve).

²³ Chart. R. 39 & 40 Edw. III, m. 7, 20, 21.

²⁴ Chan. Inq. p.m. 44 Edw. III (1st nos.), no. 37.

²⁵ *Ibid.*; see Close, 50 Edw. III, pt. ii, m. 13, 12, 9.

²⁶ See Chauncy, *Hist. Antiq. of Herts.* 147; Berry, *Herts. Gen.* 74; Morant, *Hist. and Antiq. of Essex*, i, 393.

²⁷ Chauncy, loc. cit.

²⁸ *Ibid.* 151 (from brass in church).

²⁹ See *Feud. Aids*, ii, 446.

³⁰ Chan. Inq. p.m. 24 Hen. VI, no. 29.

³¹ *Ibid.* 15 Edw. IV, no. 37.

³² *Parl. R.* vi, 504a.

³³ *Ibid.* 554a.

³⁴ Chan. Inq. p.m. (Ser. 2), xxxviii, 24.

³⁵ *Ibid.* li, 5.

³⁶ He levied a fine of the manor in 1558 (Feet of F. Herts. East. 4 & 5 Phil. and Mary).

³⁷ *Ibid.* East. 5 Eliz.; see *Visit. of Herts.* (Harl. Soc.), 150.

³⁸ M. I.

³⁹ Chan. Inq. p.m. (Ser. 2), ccxix, 133.

⁴⁰ His will is dated 1594. See Newcourt, *Repertorium*, i, 791.

⁴¹ *Visit. of Herts.* loc. cit.

⁴² Feet of F. Herts. Mich. 36 & 37 Eliz.

⁴³ *Ibid.* Mich. 39 & 40 Eliz.

⁴⁴ Chan. Inq. p.m. (Ser. 2), cccxxxv, 8.

A HISTORY OF HERTFORDSHIRE

In 1617 Simeon Brograve was granted free fishery and free warren in Albury.⁴⁶ He died in January 1638-9, and his half of the manor, with a messuage called Albury Lodge, descended to his son John,⁴⁷ whose son Thomas Brograve was created a baronet in March 1662-3.⁴⁸ He died in 1670 and was succeeded by his son John.⁴⁹ The other half of the manor, on the death of Richard Frank in 1627, descended to his son Leventhorpe Frank,⁵⁰ who had five daughters, Susan, Anne, Mary, Frances and Dorothy.⁵¹ In 1640 he with his daughters Anne and Frances levied a fine of two fifths of one half of the manor of Albury, probably on the marriage of his daughter Anne with Robert son of Richard Hale of Tewin,⁵² for Richard Hale appears as a party to the settlement.⁵³ In 1646 Robert Hale and Anne his wife, Thomas Pix and Dorothy his wife and Frances Frank held a court of the manor with John Brograve.⁵⁴ Robert and Anne afterwards became possessed of half of the manor by the purchase of the shares of Thomas and Dorothy Pix and of Frances Frank,⁵⁵ and in 1661 they sold it, with the mansion-house called Albury Hall, to Sir Edward Atkins, baron of the Exchequer.⁵⁶ Sir Edward Atkins was one of the most celebrated judges during the Commonwealth. In 1640 he had been appointed baron of the Exchequer by the king, but as the order did not take effect he was created anew by the Commons in 1645. He continued to hold his office after the Restoration, and was one of the judges who presided over the trial of the regicides, but he took no active part in the proceedings.⁵⁷ After the purchase of Albury Baron Atkins resided at Albury Hall,⁵⁸ and died there in 1669.⁵⁹ His half of the manor descended to his son Edward, who sold it five years later to Thomas Bowyer, from whom it passed to Felix Calvert of Furneux Pelham.⁶⁰ In 1688 Felix Calvert sold the manorial rights pertaining to this half to Sir John Brograve, bart.,⁶¹ who held the other half, and the two halves of the manor thus became united. On the death of Sir John Brograve in 1691 Albury passed to his brother Sir Thomas Brograve,⁶² who suffered a recovery of the manor in order to bar the entail.⁶³ He died without issue in 1707,⁶⁴ when his heirs were his sisters Jemima Brograve and Honora wife of John Stevenson. Jemima died before 1712, when many of her brother's estates were sold to one of his creditors, Ralph Freeman,⁶⁵ and in 1713 Honora, with her husband John Stevenson, Ralph Freeman, jun., and Robert Elwes, quitclaimed all right in the manor of Albury to John Ward.⁶⁶

The manorial rights were afterwards acquired by Felix Calvert, nephew of Felix Calvert who had

formerly held half of the manor, but this purchase did not include the lands of the Brograves' half.⁶⁷ Felix Calvert died in 1736,⁶⁸ and was succeeded by a son of the same name, who held the manor⁶⁹ until his death in 1755,⁷⁰ when it descended to his son John Calvert,⁷¹ who was member of Parliament for Wendover in 1754 and afterwards sat several times for Hertford.⁷² On his death in 1808 Albury passed to his son John Calvert, who was member successively for the boroughs of Malmesbury, Tamworth, St. Albans and Huntingdon, and also secretary to the lord chamberlain.⁷³ He died in 1844 and the manor was sold by his trustees in 1847 to Richard Dawson of Withcall, co. Lincoln, who died in 1868, when Albury descended to his daughter and heir Fanny, who married the Rev. E. J. Rogers. The manor was purchased in 1873 by John Stock Clark, a large copyholder in it, who wished to enfranchise his holdings. He died in 1884, when the manor passed to his four children, three of whom conveyed their shares to their brother Christopher James Clark in 1898. In 1899 he sold the manor to Mr. H. A. Hare of Much Hadham, the present lord.⁷⁴

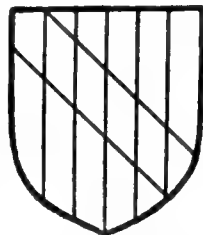

CALVERT. *Paly or and sable a bend counter-coloured.*

In the reign of Edward the Confessor the manor of *PATMORE* or *PATMORE HALL* (Patemere, xi cent. ; Podmore, Patermere, xiii cent. ; Patesmere, Padymere, xiv cent. ; Pattermerhall, xv cent. ; Patmer Hall, xvii cent.) was part of the lands of Earl Algar and was held of him by Alward. After the Conquest, like Albury, it became a member of the barony of Stortford,⁷⁵ and was held of the Bishops of London⁷⁶ by a yearly payment of 6s. 1d. for sheriff's aid and castle guard and by suit rendered at the bishop's court at Stortford.⁷⁷ The yearly rent of 5s. for castle guard seems to be still paid to the lord of the castle manor.⁷⁸

Baldwin was tenant in fee of the manor of Patmore in 1086,⁷⁹ and it was afterwards held by a family which derived their name from the manor. In 1166 William de Patmore was holding one knight's fee and a third of a fee of the Bishop of London,⁸⁰ and at the beginning of the 13th century these fees, which evidently represent the manor of Patmore, had descended to Walter de Patmore,⁸¹ who gave land in Upwick and part of a feeding in Upwicksbroom to the nuns of Holywell (St. Leonard's, Shoreditch).⁸² The manor was afterwards held by John de Patmore,⁸³

⁴⁶ Pat. 15 Jas. I, pt. xv.
⁴⁷ Chan. Inq. p.m. (Ser. 2), cccxcxi, 18.
⁴⁸ G.E.C. *Complete Baronetage*, iii, 272.
⁴⁹ *Ibid.*
⁵⁰ Chan. Inq. p.m. (Ser. 2), ccccxlii,
⁵¹ Chauncy, loc. cit.
⁵² *Ibid.*
⁵³ Feet of F. Div. Co. Mich. 16 Chas. I.
⁵⁴ Chauncy, loc. cit.
⁵⁵ *Ibid.*
⁵⁶ Close, 13 Chas. II, pt. xxiii, no. 14.
⁵⁷ *Diet. Nat. Biog.*
⁵⁸ See *Cal. S. P. D:m.* 1663-4, p. 259
⁵⁹ *Diet. Nat. Biog.*
⁶⁰ Chauncy, loc. cit.
⁶¹ *Ibid.* Salmon says that this half

descended from Felix Calvert to his son William, who sold it to his cousin Felix Calvert (Salmon, *Hist. of Herts.* 283), but this can only refer to the lands and not to the manorial rights which he says the Brograves purchased of Felix Calvert of Furneux Pelham.
⁶² G.E.C. loc. cit.
⁶³ Close, 3 Will. and Mary, pt. ix, no. 22.
⁶⁴ G.E.C. loc. cit.
⁶⁵ See manor of Hamells in Braughing.
⁶⁶ Feet of F. Herts. Trin. 12 Anne.
⁶⁷ Salmon, loc. cit.
⁶⁸ *V.C.H. Herts. Families*, 65.
⁶⁹ See Feet of F. Herts. East. 24 Geo. II ; *Recov. R. East. 24 Geo. II, rot. 53.*
⁷⁰ *V.C.H. Herts. Families*, 65.

⁷¹ See *Recov. R. Trin. 30 & 31 Geo. II, rot. 198* ; *East. 44 Geo. III, rot. 23.*
⁷² *V.C.H. Herts. Families*, 67.
⁷³ *Ibid.*
⁷⁴ Cussans, *Hist. of Herts. Edwinstree Hund.* 158 ; information from Mr. W. Minet.
⁷⁵ *V.C.H. Herts.* i, 306b.
⁷⁶ See Chan. Inq. p.m. 24 Hen. VI, no. 29 ; (Ser. 2), ix, 147.
⁷⁷ *Cal. Inq. p.m. 1-19 Edw. I*, 371.
⁷⁸ *East Herts. Arch. Soc. Trans.* ii, 238.
⁷⁹ *V.C.H. Herts.* i, 306b.
⁸⁰ *Red Bk. of Exch. (Rolls Ser.)*, i, 186.
⁸¹ *Ibid.* ii, 541, 542.
⁸² *Cal. Chart. R.* 1226-57, p. 201.
⁸³ See *De Banco R.* 15, m. 6 d.



ALBURY · HALF-TIMBERED HOUSE ADJOINING THE CHURCHYARD



ALBURY CHURCH : LATE 14TH-CENTURY MONUMENT

who died before 1276, when his widow Joan was holding a third of the manor in dower.⁸⁴ John de Patmore had married the daughter of William Baud of Hadham, and had enfeoffed William of the other two parts of the manor, but after William's death an action to recover them was brought against his widow Philippa by William Monchensey (who is said to have had a life grant of the manor from John de Patmore)⁸⁵ on the plea that the grant to William Baud had not been in fee.⁸⁶ William Monchensey forfeited before 1291, when the custody of Patmore was granted to Stephen Fitz Walter,⁸⁷ and on his death it was granted to Robert Fitz Walter in 1295.⁸⁸ Philip de Patmore recovered seisin of the manor against William Monchensey in 1297,⁸⁹ and was holding the manor in 1303.⁹⁰ He died before 1313 when his son John and Sarah his wife were holding the manor.⁹¹ In 1321-2 the tenants of Patmore petitioned Parliament against Sir John de Patmore, whom they accused of imprisoning them at will and extorting sums of money for their redemption.⁹² There is no evidence of their obtaining redress; but as Sir John was an adherent of the Earl of Lancaster he was obliged soon after to flee the kingdom, and in 1324 the manor was granted by the king to Simon de Mountbreton.⁹³ In 1327 it was restored to Sarah wife of John de Patmore at her 'suggestion' that her husband's lands had been seized owing to the enmity between himself and Hugh le Despenser the younger.⁹⁴

John de Patmore died before 1361, when the manor was held by his son John de Patmore,⁹⁵ whose widow Parnel was holding in 1366.⁹⁶ She was wife successively of John atte Barre and William Rokesburgh.⁹⁷ The reversion of the manor was divided between Margaret wife of Ralph Jocelin, the daughter of John de Patmore,⁹⁸ and Alice wife of Richard Plantyng, probably another daughter. In 1366 Alice, with her husband Richard Plantyng, sold the reversion of her half to John de la Lee and Joan his wife,⁹⁹ and in Hilary term 1385-6 Thomas Jocelin, son and heir of Margaret Jocelin,¹⁰⁰ sold the reversion of the other half of the manor to Sir Walter de la Lee, kt.,¹ son and heir of Sir John de la Lee, who had died in 1370.² In 1387 Sir Walter received a quitclaim from William and Parnel de Rokesburgh,³ and he

died seised in 1395, when his three sisters were his co-heirs.⁴ In Hilary term 1406-7 Margery Newport and Joan Barley conveyed the manor to Robert Sewale and Margery his wife,⁵ who seem, however, later to have released their right in favour of Joan Barley,⁶ for in 1428 the manor of Patmore was held by her son John Barley.⁷

On the death of Henry Barley in January 1475-6⁸ the manor passed to Thomas Barley (probably a younger son), whose daughter and heir Katherine married John Harleston. On her death the manor descended to her daughter and heir Agnes, who married Thomas Scroggs. Agnes died before her husband, who held Patmore until his death in 1538.⁹ His heir was his son Francis,¹⁰ from whom the manor descended in 1585 to his son John Scroggs,¹¹ who died seised in 1592.¹² Edward his son was aged six at his father's death, and during his minority the manor was held by his mother Mary, who married as her second husband Sir Thomas Stanley.¹³ John son of Edward Scroggs¹⁴ died in 1692¹⁵; his son John was holding in 1700,¹⁶ and from him Patmore descended to his son Thomas Scroggs, barrister-at-law of the Middle Temple, who died unmarried in 1710,¹⁷ when his two sisters Mary¹⁸ and Judith were his heirs. Mary married Charles Dartequenewe, who purchased the other half of the manor from Judith and her husband John Lance.¹⁹ Charles Dartequenewe died in 1737.²⁰ Patmore was sold by his grandson Charles Peter Dartequenewe²¹ to Samuel Cockett in 1775.²² Cockett mortgaged the estate to Sir Abraham Hume, bart., and finally conveyed it in 1780 to Paul Caldwell, who paid off the mortgage.²³ Lands included in this sale are Oxlays, the Bowling Green, the Dovehouse, the Broome, Dyersfield, Stockfield, Dobin Hall Pasture, Hornbeams, Daniel Meadow, Onefoin Close, Shawes Reads.

The sale led to disputes,²⁴ and in 1781 Caldwell conveyed Patmore to John Calvert,²⁵ lord of the manor of Albury. It descended with the manor of Albury until 1848, when it was purchased from the trustees of John Calvert's will by Hugh Parnell of Much Hadham and Clapton. Hugh Parnell died in 1861, and Patmore descended to his sons Hugh and John, barristers-at-law.²⁶ On the death of Hugh in 1906 the manor passed to his cousin Mr. Franklyn

⁸⁴ See De Banco R. 15, m. 9 d.

⁸⁵ Chan. Inq. p.m. 14 Edw. I, no. 27.

⁸⁶ Assize R. 323, rot. 5 d.; De Banco R. 17, m. 62. William Monchensey also claimed Joan Patmore's third by grant of her second husband Ralph de Poley, but Joan was able to prove a divorce between herself and Ralph (De Banco R. 15, m. 9 d.).

⁸⁷ Cal. Pat. 1281-92, p. 416; Cal. Fine R. 1272-1307, p. 288.

⁸⁸ Cal. Fine R. 1272-1307, p. 362; Abbrev. Rot. Orig. (Rec. Com.), i, 90.

⁸⁹ Assize R. 1311, m. 111 d.

⁹⁰ Feud. Aids, ii, 431.

⁹¹ Feet of F. Herts. 7 Edw. II, no. 143.

⁹² Parl. R. i, 389a.

⁹³ Cal. Pat. 1324-7, p. 4; Cal. Close, 1323-7, p. 291.

⁹⁴ Cal. Close, 1327-30, pp. 38, 153. One-third of the manor was still held by Alice widow of Philip de Patmore.

⁹⁵ Ibid. 1360-4, p. 275.

⁹⁶ See Feet of F. Herts. 40 Edw. III, no. 571; 9 Ric. II, no. 79; Lond. Epis. Reg. Braybrook, fol. 394.

⁹⁷ Ibid.

⁹⁸ Visit. of Essex (Harl. Soc.), 228.

⁹⁹ Feet of F. Herts. 40 Edw. III, no. 571.

¹⁰⁰ See Visit. of Essex, loc. cit.

¹ Feet of F. Herts. 9 Ric. II, no. 79.

² Chan. Inq. p.m. 44 Edw. III (1st nos.), no. 37.

³ Feet of F. Herts. 11 Ric. II, no. 92.

⁴ See above under Albury.

⁵ Feet of F. Herts. 8 Hen. IV, no. 42.

⁶ See ibid. no. 53; Close, 9 Hen. V, m. 5 d.

⁷ Feud. Aids, ii, 446. The manor is said to have been formerly held by John Sherborn, who appears to have been a trustee of Sir Walter Lee's estates. See Salmon, *Hist. of Herts.* 284.

⁸ See above.

⁹ Chan. Inq. p.m. (Ser. 2), lx, 147.

¹⁰ Ibid.; see Feet of F. Herts. East.

¹¹ Hen. VIII.

¹² Cussans, *Hist. of Herts. Edwinstree Hund.* 162; see Feet of F. Herts. Mich.

¹³ & 32 Eliz.

¹⁴ Chan. Inq. p.m. (Ser. 2), ccl, 69.

¹⁵ Exch. Dep. Mich. 5 Jas. I, no. 21; see Salmon, *Hist. of Herts.* 284.

¹⁶ Chauncy, *Hist. Antiq. of Herts.* 151.

¹⁷ M. I.

¹⁸ Chauncy and Salmon, loc. cit. Cussans says, however, that the younger John died before his father and was buried at Albury in 1685. Cussans, loc. cit.

¹⁹ Clutterbuck, *Hist. and Antiq. of Herts.* iii, 338 (M. I.).

²⁰ Feet of F. Herts. Trin. 12 Anne; Recov. R. Trin. 13 Anne, rot. 31.

²¹ Salmon, *Hist. of Herts.* 284.

²² Clutterbuck, *Hist. and Antiq. of Herts.* iii, 338 (M. I.).

²³ Clutterbuck, op. cit. iii, 336; see Recov. R. Mich. 9 Geo. III, rot. 254.

²⁴ Clutterbuck, op. cit. iii, 336.

²⁵ Com. Pleas D. Enr. East. 20 Geo. III, m. 201.

²⁶ Clutterbuck, loc. cit.

²⁷ Feet of F. Herts. East. 21 Geo. III.

²⁸ Cussans, op. cit. *Edwinstree Hund.* 162.

A HISTORY OF HERTFORDSHIRE

Arden Crallan, who sold the estate in 1912 to Mr. Frank B. Debenham, the present lord of the manor.²⁷

The manor of *UPWICK* *alias* *UPWICK HALL* (Uppewyk, xv cent.) probably formed part of the Bishop of London's holding in 1086, for it was always held of the Bishop of London's fee.²⁸ At the beginning of the 13th century Osbert Masculus was holding half a knight's fee of the bishop,²⁹ which may probably be identified with the manor of Upwick, as it was afterwards held by Richard Masculus.³⁰ It descended on his death to his son and heir William Masculus, aged nineteen in 1244.³¹ In 1303 William le Madle was holding half a knight's fee in Albury,³² which probably represents this manor. Upwick afterwards came into the possession of the Lees, lords of the manor of Albury. In 1370 Sir John de la Lee, kt., died seised of it. His heir was his son Walter,³³ but in 1386 the manor was held by Nicholas Fitz Richard and Alice his wife in the right of Alice.³⁴ They conveyed it to Roger Lambourn and others,³⁵ possibly in trust for Walter Baud. In 1420 Walter Baud settled Upwick on himself for life with reversion to his wife Katherine for life and successive remainders to the sons of Walter and Katherine, and in default to Walter son of his brother John Baud, to whom he had recently stood godfather, to John son of John Baud, and to William son of another brother, Thomas Baud, in tail-male.³⁶ Walter Baud died without issue in that year,³⁷ and his nephews also appear to have died without issue, as his brother Thomas Baud became his heir.³⁸ Walter's widow Katherine appears to have married as her second husband William Godered, for in 1428 William Godered and Katherine conveyed the manor of Upwick to Thomas Baud the elder, Thomas Baud the younger and Margery his wife.³⁹

Thomas Baud died in 1430 and his son Thomas in 1449, when Upwick descended to the latter's son Ralph, who died seised of it in 1483.⁴⁰ His son Thomas Baud inherited the manor,⁴¹ and mortgaged it with his other estates in 1503. These were sold in 1504 to Lord Darcy, who redeemed the mortgage.⁴² He probably conveyed the manor to the Elliots. In 1519 Thomas Baud's widow Anne, then the wife of John Blenarhasset, quitclaimed her right to John Aleyn and others,⁴³ probably in trust. In 1558 the manor was held by Magnus Elliot, who quitclaimed all right in it to John Elliot.⁴⁴ It descended to George Elliot, who with his wife Joan conveyed it in 1574 to William Parker, citizen and lindraprer of

London.⁴⁵ Three years later William Parker conveyed it to Humphrey Corbett,⁴⁶ who died seised of it in 1609.⁴⁷ Humphrey's kinsman and heir Roland Corbett made a settlement of the manor in 1624 on the occasion of the marriage of his son Richard with Jane daughter of Sir Thomas Fowler, kt.⁴⁸ In 1636 he sold Upwick to William Stacey,⁴⁹ who died seised of it in 1660, when it descended to his son Edward, living in 1695.⁵⁰ It passed to his son Edward Stacey,⁵¹ and has since remained with this family,⁵² Mr. Frank Stacey of Wickham Hall, Bishop's Stortford, being the present owner.

The manor of *DARCIES* (Dacres, xvi cent.; Dorses, xvii cent.) in Albury was held of the Bishop of London.⁵³ The earliest record of this manor seems to be in 1376, when it was held by Sir Walter de la Lee, kt., with the manor of Albury.⁵⁴ On the division of Sir Walter's property among his sisters and co-heirs⁵⁵ Darcies descended with Patmore⁵⁶ (q.v.), but on coming into the hands of the Barleys it was again united with Albury (q.v.), and from that time always descended with it. The last reference found to it as a separate manor is in 1713.

The *RECTORIAL MANOR* of Albury was originally held by the Bishop of London, and was said to have been one of the manors which were attached to his table.⁵⁷ In the reign of Stephen, Robert de Sigillo, Bishop of London, gave it to Godfrey, the first treasurer of St. Paul's.⁵⁸ There were 6 acres of demesne land, for which the treasurer had to find a light in the church every night.⁵⁹ These appear to be the lands which in the 16th century were called Lampland and Torchland.⁶⁰ There were also 10 acres in demesne held of the sheriff, to whom an annual payment was due.⁶¹ As ecclesiastical property the manor was quit of the king's purveyors.⁶² The treasurer was accustomed to lease out the parsonage, reserving to himself the manorial rights and also the right to have a stable there for his horses. By a 16th-century lease the treasurer was bound to repair the parsonage-house with timber and to keep in repair all tiled houses, while the lessee was to repair the thatched houses.⁶³ In the 17th century the rectory manor was leased to the Leventhorpes and afterwards to the Brograves, lords of the manor of Albury⁶⁴ (q.v.). During the Commonwealth the rectory was sequestrated as part of the possessions of St. Paul's Cathedral,⁶⁵ but it was afterwards restored to the treasurer, who held it until the middle of the 19th century, when the Venerable Archdeacon Jones, the treasurer, sold it

²⁷ Information from Mr. F. A. Crallan.

²⁸ See *Cal. Inq. p.m. Hen. III*, 9; *Chan. Inq. p.m.* (Ser. 2), cccxiv. 129.

²⁹ *Red Bk. of Exch.* (Roils Ser.), ii, 541.

³⁰ *Cal. Inq. p.m. Hen. III*, 9.

³¹ *Ibid.*

³² *Feud. Aids*, ii, 432.

³³ *Chan. Inq. p.m.* 44 Edw. III (1st nos.), no. 37.

³⁴ Feet of F. Div. Co. 9 Ric. II, no. 55.

³⁵ *Ibid.*

³⁶ *Anct. D.* (P.R.O.), A 11498.

³⁷ Chauncy, op. cit. 159 (M. I.).

³⁸ For an account of this family see the manor of Little Hadham.

³⁹ Feet of F. Herts. 6 Hen. VI, no. 33.

⁴⁰ *Chan. Inq. p.m.* 1 Ric. III, no. 6.

⁴¹ *Ibid.*

⁴² Minet, 'The Bauds of Corynham

and Hadham Parva,' *Essex Arch. Soc. Trans.* (New Ser.), x, 145.

⁴³ Feet of F. Herts. Mich. 11 Hen. VIII.

⁴⁴ *Ibid.* East. 4 & 5 Phil. and Mary; *Recov. R. Mich.* 1558, rot. 515.

⁴⁵ Feet of F. Herts. Mich. 16 & 17 Eliz.

⁴⁶ *Recov. R. Hil.* 1577, rot. 752.

⁴⁷ *Chan. Inq. p.m.* (Ser. 2), cccxiv, 129.

⁴⁸ *Ibid.* cccclxxvi, 108; Feet of F. Div. Co. Trin. 22 Jas. I; *Recov. R. Trin.* 22 Jas. I, rot. 37.

⁴⁹ Inform. from Mr. F. Stacey.

⁵⁰ Chauncy, op. cit. 150, gives 1633; *Salmon, Hist. of Herts.* 283.

⁵¹ *Exch. Dep. Trin.* 7 Will. III, no. 5; see Chauncy, loc. cit.

⁵² *Salmon, loc. cit.*

⁵³ cf. Feet of F. Herts. Mich. 41 Geo. III.

⁵⁴ *Chan. Inq. p.m.* (Ser. 2), li, 5.

⁵⁵ Close, 50 Edw. III, pt. ii, m. 13, 12, 9.

⁵⁶ See manors of Albury and Patmore.

⁵⁷ See Feet of F. Herts. 8 Hen. IV, no. 42, 53.

⁵⁸ Chauncy, op. cit. 147; Dugdale, *Hist. of St. Paul's*, fol. 9; *Newcourt, Repertorium*, i, 791.

⁵⁹ *Newcourt, loc. cit.* quoting register of Dean and Chapter of St. Paul's.

⁶⁰ *Newcourt, loc. cit.*

⁶¹ Pat. 14 Eliz. pt. ii, m. 17.

⁶² *Newcourt, Repertorium*, i, 791.

⁶³ See *Cal. Pat.* 1313-17, p. 190; 1321-4, pp. 52, 221.

⁶⁴ Lond. Epis. Reg. Stokesley, fol. 50.

⁶⁵ See *Chan. Proc.* (Ser. 2), bde. 421, no. 45; Close, 1651, pt. xxvi, no. 25; 7 Will. III, pt. vii, no. 23; Feet of F. Herts. Trin. 4 Anne.

⁶⁶ Close, 1651, pt. xxvi, no. 25.

to the Ecclesiastical Commissioners. In 1867 it was purchased by the Dean and Chapter of Westminster,⁶⁶ and has recently been bought from the Ecclesiastical Commissioners by Mr. Maurice Carr Glyn.⁶⁷

The parish church of *ST. MARY CHURCH* stands on a hill at the eastern end of Albury village. The material is flint with clunch dressings and modern roofing of tiles or lead. The church consists of a chancel 28 ft. 6 in., nave 52 ft. by 15 ft. 6 in., aisles 9 ft. wide, west tower 13 ft. square, south porch, and a vestry and organ chamber on the south side of the chancel.

The earliest church of which any portion remains, consisting of a nave, aisles and chancel of about 1230, now survives only in the chancel, but the Purbeck marble stem and one small shaft of a late 12th-century font are remains of the 12th-century church which is known to have stood here.⁶⁸ The nave, aisles and chancel arch were rebuilt about 1360. Ninety years later the west tower was built, and the south porch was added in the latter half of the 15th century. In the 19th century the vestry and organ chamber were added, and the clearstory windows over the south arcade of the nave were pierced about the same time. The church has undergone much restoration in recent years. The quoins and window tracery of the tower are all new, the south wall of the south aisle has just been rebuilt, and nearly all the external stonework of the windows has been renewed.

The chancel has three modern lancets in the east wall. On the north side are four original 13th-century lancets, of which the westernmost is a low-side window. The south side has only two lancets, also original, and a piscina of the 14th century, with an ogee-trefoiled head, and a hood mould ornamented with crockets and a finial. The bowl is modern. The communion table is of the late 17th century. There is a rood screen of 15th-century work which has tracery in the head, and the closed panels below the middle rail are pierced by small round holes. The chancel arch, which forms part of the 14th-century rebuilding, is of two moulded orders, with jambs of alternate shafts and rolls. This type is followed by the arcades of the nave of the same date, which are of four bays. The two westernmost bays on the south side, however, are plainer in detail, and were probably the last to be finished. The clearstory lights above the arcade on the south side are modern.

Three of the tie-beams and wall-plates of the roof are of the 15th century.

In the north aisle, at the east and west ends, are two original 14th-century windows, much repaired, each of three lights. The three 15th-century windows in the north wall have lost their tracery. There was also originally a 14th-century doorway in the north wall, but this is now blocked up. In this aisle, and in the south aisle also, the trusses of the roof are of the 15th century. The south aisle, which, as already noted, has undergone extensive reconstruction, has an original 14th-century east window of three lights,

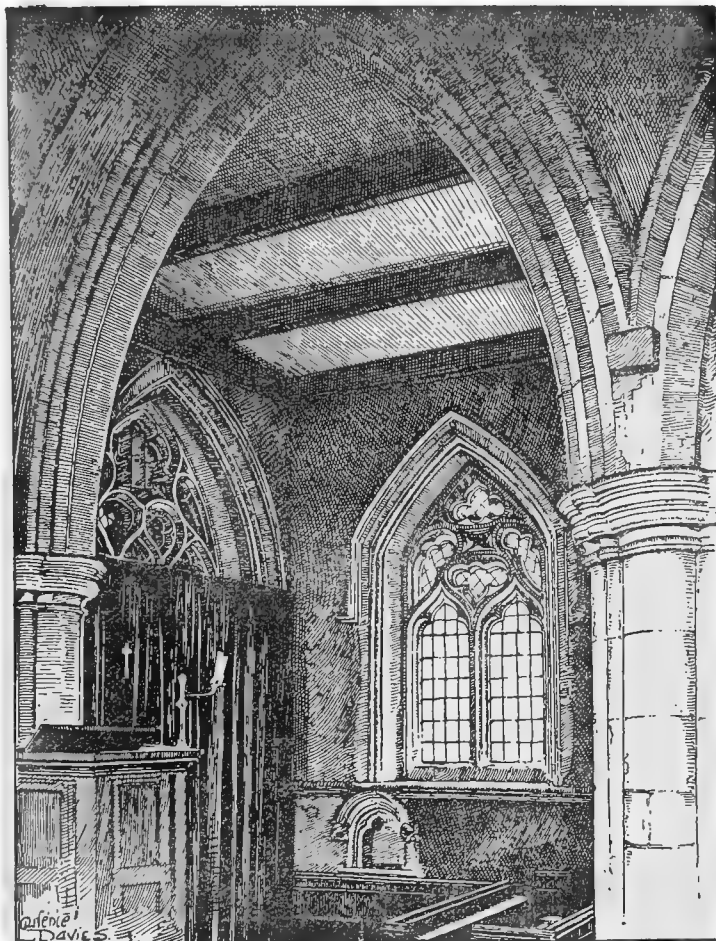

ALBURY CHURCH: EAST END OF THE SOUTH AISLE

now inclosed by the vestry and organ chamber, three windows on the south and one on the west of two lights each, also of the original structure; only the east and south-east windows, however, have escaped renewal, and the latter is in a very decayed condition. There is a stoup on the east side of the south door.

The tower of three stages has diagonal buttresses and an embattled parapet, and is surmounted by a small leaded needle spire. The west doorway has a

⁶⁶ Cussans, *Hist. of Herts. Edwinstree Hund.* 168; see *Lond. Gaz.* 28 June 1867, p. 3623.

⁶⁷ Information from Rev. J. L. P. Thomas.

⁶⁸ See Advowson. The church was

granted to the treasurer of St. Paul's in the reign of Stephen.

A HISTORY OF HERTFORDSHIRE

pointed arch in a square head with tracery and roses in the spandrels. The jambs are much decayed. At the foot of the tower staircase is a door with 15th-century ironwork. The south porch, which has undergone much restoration, has windows in the east and west walls. The entrance is a pointed arch in a square head. The tower arch is of three moulded orders with shafted jambs. The font now in use is modern. Reference has already been made to the remains of a font of earlier date. The pulpit is made up of early 17th-century panelling, and has the arms of Leventhorpe and other families inlaid in wood.

The monuments include one of especial interest, that of an unknown knight and his lady, of the late 14th century, probably Sir Walter or Sir John de la Lee. It stands in the north aisle and is a fine altar tomb with panelled sides and effigies in clunch, which afford an excellent example of costume and armour. The knight is attired in a short hauberk and a richly ornamented jupon. He wears a bascinet with the hinge for the visor plainly indicated; the aventail, jambs, thigh-pieces and brassarts are also ornamented, and he wears plate gauntlets. His head rests on a fine helm with its lambrequin, surmounted by the crest, a kneeling angel. The lady wears a sideless gown and her hair is inclosed in an elaborate hair-net. The inscription is lost, and the arms and hands of the figures are gone, except the knight's left upper arm and the tips of his fingers.

There is a brass in the nave of an unknown knight in armour, his wife and child; there is also a crest on the brass; the inscription is lost. Also in the nave are a brass of John Scroggs, his wife and child, with two shields^{68a} and a skull above, 1592, and floor slabs to Sir Leventhorpe Frank, 1657, and John Scroggs and his wife Elizabeth, 1692. On the north wall of the north aisle are three detached brass shields and a brass record of a 16th-century charity left by Ann Barley. On the south wall of the south aisle are a brass of Thomas Leventhorpe, 1588, his wife Dorothy, daughter of William 'Barlee,' and six children, and two 14th-century roundels with symbols of the Evangelists.

The bells are three in number: the first and second are by Henry Jurdens of London, who died in 1470, and, therefore, date from about the time of the erection of the tower; the third is by Robert Oldfeild and is dated 1607.

The plate includes a cup of 1626.

The registers previous to 1812 are as follows: (i) all entries 1558 to 1657; (ii) 1669 to 1730; (iii) baptisms and burials 1730 to 1812 and marriages 1730 to 1754; (iv) marriages 1754 to 1812.

^{68a} The arms ascribed to Scroggs of Patmore in Mundy's additions to Herts. Pedigrees (Harl. MS. 1546), printed in *Visit. of Herts.* (Harl. Soc.), Appendix II, 163, are: Argent a bend azure between two greyhounds running bendwise sable with three peewits or on the

bend. They are entirely different from those on this brass, which are a cross engrailed between four cinquefoils. The second shield on the brass has a chevron between three boars' heads, for Burton.

⁶⁹ Newcourt, *Repert.* i, 791.

⁷⁰ *East Herts. Arch. Soc. Trans.* ii, 229.

The church of Albury was granted *ADVOWSON* by Robert de Sigillo, Bishop of London, to the treasurer of St. Paul's,⁶⁹ who appropriated it. The church was a peculiar of the Bishop of London, exempt from all jurisdiction except that of the bishop.⁷⁰ The treasurers of St. Paul's held the rectory and advowson⁷¹ until 1845, when the patronage was transferred to the Bishop of Rochester, the Venerable Archdeacon Jones, then treasurer, retaining the right of presentation during his lifetime.⁷² After the creation of the bishopric of St. Albans in 1877 Albury was transferred to that diocese, and the patronage of the church is now in the hands of the Bishop of St. Albans.

There was a chantry in the church of Albury to which 56 acres of land were attached,⁷³ but nothing further is known of it.

In 1587 Francis Gunter, in consideration of a certain devise by will of Mrs. Ann Gunter, his mother, charged an estate in Standon with an annuity of £3 for the distribution of 12*d.* in bread every Sunday, 6*s.* for a sermon in Easter week, 1*s.* to the vicar, and 6*d.* to each of the churchwardens. The annuity is now represented by £100 consols, of which £87 5*s.* 5*d.* stock has been apportioned to the poor and £12 14*s.* 7*d.* stock, producing 6*s.* 8*d.* yearly, for the ecclesiastical payments.

In 1594 Thomas Leventhorpe by his will devised his interest in certain hereditaments situated in Whitecross Street, St. Giles Without Cripplegate, London, one-half of the profits to be for the use of the poor of Albury and the other half to the use of the vicar. In 1867 the land was sold to the Metropolitan Railway Company and the proceeds invested in £1,425 19*s.* 4*d.* consols, of which one moiety (£712 19*s.* 8*d.* stock) has been transferred to the governors of Queen Anne's Bounty for the benefice and the other moiety retained for the poor.

In 1822 Thomas Mott by his will left £4 a year to be distributed in bread or money among twelve of the poorest families. The legacy is represented by £150 6*s.* 10*d.* consols.

The several sums of stock, except where otherwise stated, are held by the official trustees. The annual income applicable for the benefit of the poor, amounting to £23 15*s.*, is distributed in coals.

The Poor's Land.—A sum of £3 a year is also received as rent of an acre of land, of which £1 is given to the oldest widow and £3 10*s.* as the rent of certain cottages, presumably derived from the charity of the Rev. Marmaduke Bickendyke, a former vicar, will, 1589, and of Sarah Bishop, 1762.

⁷¹ *Pope Nich. Tax.* (Rec. Com.), 196; *Cal. Pat.* 1313-17, p. 190; *Lond. Epia. Reg.* Stokesley, fol. 50; Close, 1651, pt. xxvi, no. 25; *Inst. Bks.* (P.R.O.), 1733, 1804.

⁷² Cussans, *op. cit.* *Edwinstree Hund.* 168. ⁷³ *Pat.* 14 Eliz. pt. ii, m. 7.

ANSTEY

Anestige, Anestei (xi cent.); Anastia (xii cent.); Anesty (xiii and xiv cent.); Anstey-ad-Castrum (xv, xvii and xviii cent.).

The parish of Anstey has an area of 2,150 acres. The altitude varies from 444 ft. near Puttock's End to 300 ft. near the south-western extremity of the parish. On the higher land to the east of the village are Hale Hill, the Rectory, which is surrounded by a moat, and Hale Farm, near to which is a moated tumulus, whilst to the south-west is Lincoln Hill, near Anstey windmill, and south of this Fox Hill. The soil is clay and chalk, with gravel in small quantities. Of the woods which figure largely in the early history of Anstey there remain principally East Wood, partly in Nuthampstead, which is mentioned in 1301-2,¹ and Northey Wood in the north-west part of the parish.

Of other early place-names Payneshalle, Payneshallegrene, and the croft called Panefeld, which occur in 1478,² may probably be identified with Pains End near Northey Wood, where is a homestead moat. Burryfelds mentioned at the same date as lately part of the demesne may be connected with modern Burry Farm, Hale with Hale Farm and Hale Hill, Snowdon with Snow End,³ and Ladylye with Ladylike Grove.⁴ In 1610 there is reference to land called Londayes,⁵ which may have been identical with or situated near Lundas Grove. There is mention also of the field called Berdene⁶ (xiii cent.), Westmore,⁷ Pesecroft and Leyhegg⁸ (xiv cent.), Burstalfeld, Vorlowfeld, Wasshedell, Litelmedefeld, Ladyesacre, Oberneffend, Collefat Mede, Baillyhill, Hungyrhill, and the suggestive Lymekeylnshotte, Chapelgate and Ansty Galwes⁹ (xv cent.), Puttock End and Parlebiens¹⁰ (xvii cent.).

The parish is traversed by the North Road, which is partly coincident with its western boundary and which crosses the River Quin at Biggin Bridge and Stapleton Bridge. The village is situated on a winding

road from Brent Pelham village, which is eventually connected with the North Road. At its junction with the road to the North Road is the hamlet called Snow End, north of which is the ancient village containing the church, the school and the hall, the latter near the site of the castle. At the entrance to the churchyard is a picturesque mediaeval lychgate. It is of timber and divided into three bays, one of which has been built up with red brick to form the village lock-up.

At the north-western end of the parish is Biggin, where stood the biggin or hospital of St. Mary. Here is Biggin Farm, surrounded by a moat. Bandons is north-west of the village beyond Northey Wood.

Two rectors of the parish were men of distinction. James Fleetwood, chaplain to Charles II, became

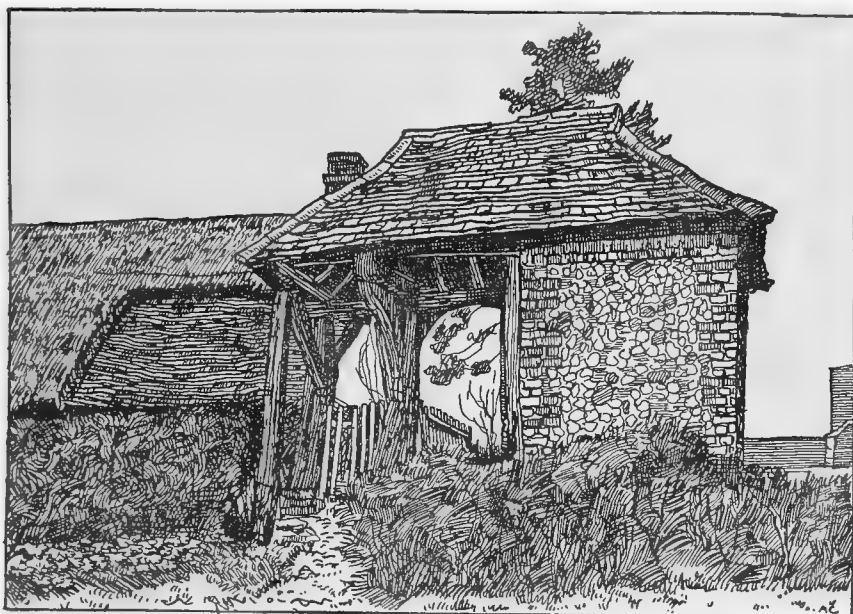

ANSTEY: LYCHGATE TO CHURCHYARD

rector of Anstey after the Restoration, and subsequently in 1675 was instituted Bishop of Worcester. In 1671 Robert Neville was presented to the rectory by Sir Roland Lytton. He was author of a five-act comedy called 'The Poor Scholar.'¹⁰

An award for inclosing the lands of Anstey parish was granted in 1829¹¹ and supplemented in 1830 by a deed poll.¹²

Anstey is a good example of the smaller *CASTLE* type of mount and bailey castle.¹³ There are now no masonry works above ground, but its 'motte' is perhaps finer than that at Berk-

¹ Mins. Accts. bdl. 862, no. 1. Northeyfeld occurs in 1419 (Ct. R. [Gen. Ser.], portf. 176, no. 124) and Eastwood coppice and Northwood coppice in 1544 (*L. and P. Hen. VIII*, xix [1], 1035 [97]).

² Rentals and Surv. R. 268.

³ Ibid. Snowen End in Church Reg. of 1576.

⁴ Ct. R. (Gen. Ser.), portf. 176, no. 124.

⁵ Chan. Inq. p.m. (Ser. 2), cccxvi, 38.

⁶ Anct. D. (P.R.O.), A 1040.

⁷ Mins. Accts. bdl. 862, no. 1.

⁸ Ct. R. loc. cit.

⁹ Rentals and Surv. R. 268. There is a hill still known as Gallows Hill on the west side of the North Road. Ladyacre and Hungyrhill were names within living memory.

¹⁰ In 1560 the baptism of Benedict

Beaucock of Parlebiens occurs in the register (see also monuments in church below). Possibly the present rectory was once known as Parlebiens (inform. from Rev. F. R. Williams).

¹¹ *Dict. Nat. Biog.*

¹² Com. Pleas D. Enr. Mich. 3 Will. IV, m. 2.

¹³ See description of the earthworks of the castle, *V.C.H. Herts.* ii, 112.

A HISTORY OF HERTFORDSHIRE

hampstead and its deep moats are still usually filled with water. At one time it was the head of a small barony, but it was never more than a manorial stronghold and has no history. It followed the descent of the manor. According to tradition it was built by Count Eustace of Boulogne, and either he or one of his immediate successors may well have thrown up its formidable earthworks, upon which buildings of timber only would at first be erected. The castle was probably in existence when Geoffrey de Mandeville acquired the manor in 1141, for he no doubt obtained it with the object of strengthening his position along the valleys of the Lea and Stort, where, between his stronghold at Walden and London, except for Bishop's Stortford Castle, he had complete control.¹⁴ The Anstey's apparently sided with the barons against John and added to the fortifications of Anstey Castle during the Barons' War. In 1218 Nicholas de Anstey was commanded to destroy the castle before mid-Lent, so that no part of it should remain except what was built before the war.¹⁵ It is impossible to decide what part of the castle was then demolished: possibly it was the masonry keep, indications of which have apparently been found.¹⁶ The castle was still, however, of sufficient importance for the king to seize it on the death of Nicholas de Anstey in 1225, when William Fitz Baldwin was ordered to deliver the custody of it to Robert de Rokele, steward of the Archbishop of Canterbury.¹⁷ Anstey Castle is referred to in 1304,¹⁸ but by 1314 it had apparently ceased to be maintained as a castle, for in the inquisition after the death of Denise de Monchensey there is only reference to a capital messuage with garden and curtilage and no mention of the castle.¹⁹ The Hall probably stands on the site of the capital messuage just referred to,²⁰ which took the place of the castle as the residence of the manor.

*ANSTEY*²¹ was held before the Conquest by Alward, a thegn of Earl Harold, who had the right to sell it. In 1086 it was among the lands of Count Eustace of Boulogne,²² and it continued to be held of the honour of Boulogne.²³

The manor was in 1086 held by Eustace in demesne. It was assessed at 5 hides.²⁴ It passed to the Crown through the marriage of Maud daughter and heir of Eustace III Count of Boulogne with King Stephen, and was granted by King Stephen to Geoffrey de Mandeville in 1141,²⁵ but escheated to the Crown by Geoffrey's forfeiture before his death in 1144.

Richard de Anstey, who occurs in the Essex and

Hertfordshire Pipe Rolls for 1165-6²⁶ and 1166-7,²⁷ may have been a later tenant of the honour in Anstey. He was possibly succeeded by Hubert de Anstey, who held three knights' fees in Anstey, Hormead and Braughing early in the 13th century²⁸; Hubert was succeeded by Nicholas de Anstey, a minor, whose marriage and custody were granted to Robert Fitz Walter in 1210.²⁹ In 1218 Nicholas de Anstey was ordered to destroy Anstey Castle (see above).³⁰ Apparently he was succeeded by his daughter Denise, a minor, in or before 1225, when the custody of the castle was committed to the Archbishop of Canterbury.³¹ In 1242 there is mention of Isabel widow of Nicholas de Anstey,³² and in 1274-5 Denise, who had married Warine de Monchensey, held the manor³³ together with rights of free warren and the amendment of the assize of bread and ale.³⁴ She held the manor and castle by the service of half a knight's fee. The manor passed at her death to her granddaughter Denise wife of Hugh de Vere and daughter of William de Monchensey,³⁵ who held with her husband in 1305.³⁶ In 1314 she died seised of the manor of Great Anstey, which comprised a capital messuage with a garden and curtilage, 240 acres of arable land, some meadow land, 20 acres of woodland, in which were rights of common, and certain services.³⁷ Her heir was her cousin Aymer de Valence Earl of Pembroke,³⁸ son of Joan wife of William de Valence, her father's sister.³⁹ Aymer granted the manor in trust to Richard de Wynneferthing, clerk,⁴⁰ who in 1325, the year after the grantor's death, surrendered it for the purpose of settlement to the king,⁴¹ who immediately granted it to Aymer's widow Mary, with reversion to Laurence son of John Lord Hastings and grandson of Aymer's sister and co-heiress Isabel, Lady Hastings, to Eleanor daughter of Hugh le Despenser



VALENCE. *Burelly argent and azure an orle of martlets gules.*



HASTINGS. *Argent a sleeve sable.*

the younger, at this date betrothed to Laurence, and to the heirs of the bodies of Laurence and Eleanor.⁴²

¹⁴ J. H. Round, *Geoffrey de Mandeville*, 164 n., 174, 175.

¹⁵ *Rot. Lit. Claus.* (Rec. Com.), i, 350.

¹⁶ Excavations were made on the top of the 'motte' in 1903 by Mr. R. T. Andrews and Mr. W. B. Gerish, but they were of too slight a nature to give any very decisive results. The only evidence of masonry work is the mention of the great gate in a Ministers' Account (Hubert Hall, *Court Life under the Plantagenets*, App. 216), but from the appearance of the 'motte' it probably had a masonry keep.

¹⁷ *Cal. Pat.* 1216-25, p. 543.

¹⁸ *Abbrev. Plac.* (Rec. Com.), 252.

¹⁹ *Chan. Inq. p.m. Edw. II*, file 34, no. 7.

²⁰ This messuage is referred to in the Ministers' Accounts already alluded to (Hubert Hall, loc. cit.).

²¹ There is a semi-fictitious account of Anstey Manor in Hubert Hall, *Court Life under the Plantagenets*, 1-25, and some interesting information relative to the manor in the Appendix to that book, 209-28. Mr. Hall's pedigree of the Anstey family differs slightly from that given here. ²² *V.C.H. Herts.* i, 321a.

²³ *Testa de Nevill* (Rec. Com.), 273b, 275; *Assize R.* 323; *Abbrev. Plac.* (Rec. Com.), 252; *Chan. Inq. p.m. Edw. II*, file 34, no. 7.

²⁴ *V.C.H. Herts.* i, 321a.

²⁵ J. H. Round, *Geoffrey de Mandeville*, 141.

²⁶ *Pipe R. 12 Hen. II* (Pipe R. Soc.), 124.

²⁷ *Ibid.* 13 *Hen. II*, 154.

²⁸ *Testa de Nevill* (Rec. Com.), 273.

²⁹ *Ibid.* 270, 275; *Pipe R. 12 John*, m. 18 d. *Nicholas* is wrongly printed *Richard* in *Testa*, p. 269b.

³⁰ *Rot. Lit. Claus.* (Rec. Com.), i, 350.

³¹ *Cal. Pat.* 1216-25, p. 543.

³² *Cal. Close*, 1237-42, p. 479.

³³ *Hund. R.* (Rec. Com.), i, 193; *Anct. D.* (P.R.O.), A 1040; *Assize R.* 325.

³⁴ *Assize R.* 323, 325.

³⁵ *Abbrev. Plac.* (Rec. Com.), 252.

³⁶ *Feud. Aids*, ii, 439.

³⁷ *Chan. Inq. p.m. Edw. II*, file 34, no. 7.

³⁸ *Ibid.*

³⁹ *G.E.C. Complete Peerage*, vi, 204 n.

⁴⁰ *Cal. Pat.* 1324-7, p. 108.

⁴¹ *Anct. D.* (P.R.O.), C 1658.

⁴² *Cal. Pat.* 1324-7, p. 153; *Cal. Close*, 1337-9, p. 27; *G.E.C. Complete Peerage*, vi, 208, 209 notes.



ANSTEY CHURCH FROM THE SOUTH-EAST



ANSTEY CHURCH : THE NAVE LOOKING EAST

EDWINSTREE HUNDRED

ANSTEY

Laurence Hastings, whose marriage to Eleanor Despenser never took place, died in 1348 as Lord Hastings and Earl of Pembroke.⁴³

After the death, in April 1377, of Mary Countess of Pembroke, Anstey Castle and Manor were said to include a capital messuage, 410 acres of arable land, 22 acres of pasture, 24 acres of meadow, 30 acres of wood and underwood, which, owing to the thick shade of the trees, were of no value.⁴⁴ The increased extent of the manor since 1314 must be due to the inclusion with it of Little Anstey (q.v.). At this time, since none of the beneficiaries under the grant of 1325 survived, Anstey escheated to the Crown and was granted by Edward III in May and by Richard II in November 1377 to Edmund Earl of Cambridge and heirs male of his body.⁴⁵ At Edmund's death in 1402 it passed to his son Edward.⁴⁶ In 1415 Edward, who had incurred great expense in the foundation of Fotheringhay College, received licence from the king to mortgage Anstey and other lands to Henry Bishop of Winchester and others.⁴⁷ Anstey passed at Edward's death in 1415⁴⁸ to his nephew and heir Richard Duke of York.⁴⁹ The demesne lands were let in 1454-5 on a lease of twenty years.⁵⁰ On the forfeiture of the duke in 1459 the manor accrued to the Crown,⁵¹ but it was restored before his death in 1460. By Edward IV in 1461⁵² and by Richard III in 1484⁵³ it was granted to their mother Cicely Duchess of York to hold for life. It was held similarly as dower land by Elizabeth, queen of Henry VII,⁵⁴ and by Katherine of Aragon,⁵⁵ Anne Boleyn⁵⁶ and Jane Seymour.⁵⁷ The last granted a lease of the site of the manor and the demesne lands to Robert Ive, who surrendered it in 1540 and received a Crown lease of the same property for twenty-one years at an annual rent of £10.⁵⁸ In 1544 the site and capital messuage of Anstey Manor, together with lands and woods, all in the tenure of Robert Ive, were granted in fee to John Cock and his wife Anne,⁵⁹ who in 1553 received a grant of the manor and lordship.⁶⁰ John Cock, who was master of requests to Edward VI, died seised in 1557 and left a son and heir Henry.⁶¹ His widow Anne married George Penruddock, with whom she held Anstey. The site and demesne lands continued in the tenure of lessees.⁶² The manor passed after Anne's death, in accordance with her first husband's

will, to his son Henry⁶³ Cock, cofferer of the royal household, who was a knight in 1572.⁶⁴ He conveyed it in 1593 to Thomas West and others⁶⁵ for the purpose of settling the manor on himself, his wife and his daughter Elizabeth and her husband Robert West.⁶⁶ Sir Henry Cock died seised in 1610, when his heirs were Henry Lucy, son of his daughter Frances and of Sir Edmund Lucy, and his daughter Elizabeth, but by the terms of the settlement Anstey was inherited by Elizabeth at her mother's death.⁶⁷

Elizabeth Cock in 1610 was the wife of Sir Robert Oxenbridge, by whom she had a daughter and heiress Ursula.⁶⁸ She afterwards married as her third husband Richard Lucy,⁶⁹ who suffered a recovery of Anstey Manor in 1617⁷⁰ and was created a baronet in 1618.⁷¹ In 1627, on the occasion of a marriage between Ursula Oxenbridge and John Monson, son and heir to Sir Thomas Monson, bart.,⁷² the manor was settled on Sir Richard Lucy for life, with reversion to John Monson and his heirs.⁷³ Later in this year it was conveyed by Sir Richard Lucy and his wife Elizabeth and by John Monson to John Stone,⁷⁴ who died seised in 1640, leaving a son and heir Richard.⁷⁵ The latter was a knight in 1651, when with his wife Elizabeth, John Stone, his son and heir, and others he conveyed the manor to his father-in-law Richard Bennett and to Nicholas Francklyn,⁷⁶ presumably for the purposes of a settlement. In 1666 John Stone and his wife Katherine conveyed it to Sir Roland Lytton, kt.,⁷⁷ of Knebworth, who died in 1674.⁷⁸ His younger son Roland inherited Anstey by virtue of a settlement, by which he held it in tail with remainder to his eldest brother William Lytton of Knebworth. He was unmarried in 1696,⁷⁹ and at his death, after 1700,⁸⁰ Anstey passed to his brother William, who died in 1705,⁸¹ or to the latter's heirs. It subsequently descended with Knebworth⁸² until 1795, when it was sold by Richard Warburton Lytton to Samuel Robert Gausson of Brookman's Park in North Mimms, at whose death in 1812 it passed to his son of the same name.⁸³ The latter died in 1818, when his executors sold Anstey to the Right Hon. Sir William Alexander, lord chief baron of the Exchequer, who died in 1842, having devised it to his sister Isabella wife of John Peter Hankey for life, with remainder to her



LYTTON of Knebworth. *Ermine a chief indented azure with three crowns or therein.*

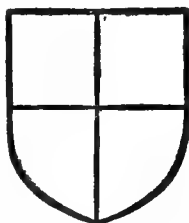

Cock. *Quarterly gules and argent.*

⁴³ G.E.C. *Complete Peerage*, vi, 209.
⁴⁴ Cussans, *Hist. of Herts. Edwinstree Hund.* 56.
⁴⁵ *Cal. Pat.* 1377-81, p. 84 ; 1416-22, p. 47 ; *Feud. Aids*, ii, 444.
⁴⁶ Chan. Inq. p.m. 3 Hen. IV, no. 36.
⁴⁷ *Campb. Chart.* x, 5 ; *Cal. Pat.* 1413-16, p. 350.
⁴⁸ Chan. Inq. p.m. 3 Hen. V, no. 45.
⁴⁹ *Feud. Aids*, ii, 453.
⁵⁰ *Mins. Accts.* bdle. 870, no. 4.
⁵¹ *Cal. Pat.* 1452-61, p. 551.
⁵² *Ibid.* 1461-7, p. 131.
⁵³ *Ibid.* 1476-85, p. 459.
⁵⁴ *Parl. R.* vi, 463a.
⁵⁵ *L. and P. Hen. VIII*, i, 155.
⁵⁶ *Ibid.* vii, 352.

⁵⁷ *Ibid.* xii (2), 975.
⁵⁸ *Ibid.* xv, 613 (36).
⁵⁹ *Ibid.* xix (1), 1035 (97).
⁶⁰ *Pat.* 7 Edw. VI, pt. ii.
⁶¹ Chan. Inq. p.m. (Ser. 2), cxi, 82.
⁶² Chan. Proc. (Ser. 2), bdle. 181, no. 1.
⁶³ *Ibid.* bdle. 31, no. 68.
⁶⁴ *Visit. of Herts.* (Harl. Soc.), 5.
⁶⁵ Feet of F. Herts. East. 35 Eliz.
⁶⁶ Chauncy, *Hist. Antiq. of Herts.* 109.
⁶⁷ Chan. Inq. p.m. (Ser. 2), cccxix, 200.
⁶⁸ G.E.C. *Baronetage*, i, 39.
⁶⁹ *Ibid.* 113.
⁷⁰ *Recov. R. Mich.* 15 Jas. I, rot. 111.
⁷¹ G.E.C. *Baronetage*, i, 113.

⁷² *Ibid.* 39.
⁷³ Chauncy, op. cit. 109.
⁷⁴ *Ibid.*
⁷⁵ Chan. Inq. p.m. (Ser. 2), cccxcv, 85.
⁷⁶ Feet of F. Div. Co. Mich. 1651.
⁷⁷ *Ibid.* Herts. East. 1666.
⁷⁸ Le Neve, *Pedigrees of Knights* (Harl. Soc.), 82.
⁷⁹ *Ibid.* 83. Le Neve describes him as *vir admodum vinolentus et somnolentus*.
⁸⁰ Chauncy, op. cit. 109.
⁸¹ *V.C.H. Herts. Families*, 199.
⁸² *Recov. R. Trin.* 20 & 21 Geo. II, rot. 273 ; and see account of Knebworth, *V.C.H. Herts.* iii, 116.
⁸³ Cussans, *Hist. of Herts. Edwinstree Hund.* 58.

A HISTORY OF HERTFORDSHIRE

daughter Julia wife of the Hon. Seymour Thomas Bathurst, third son of the fourth Earl Bathurst, for life, and to Julia's children in tail.⁸⁴ The entail was barred in 1862 by Allen Alexander, son of Mrs. Bathurst. In 1873 he and his mother sold to Charles Fredk. Adams, who died 1894. His trustees sold to Henry Edward Paine and Richard Brettell in 1895, and in 1900 Mr. Paine became sole owner.⁸⁵

In 1314 a court leet was said to be held once a year in Anstey,⁸⁶ but in 1470-1 it was held twice yearly.⁸⁷ In 1301-2, 13d. was rendered of 3s. of 'Sendyng-pennie' for a certain way and 14d. was paid for pannage⁸⁸; in 1401-2 6d. a year was paid as chevage by each of the *nativi* who lived out of the manor, which amounted in 1403-4 to 18d.⁸⁹ In 1470-1, 2s. was rendered to Hertford for castle ward,⁹⁰ and in 1508-9, 12d.⁹¹ In 1301-2 a large return was made from the dairy.⁹² The clear profit derived from the manor was £47 13s. 2½d. in 1358-9,⁹³ £24 11s. 9d. in 1403-4,⁹⁴ £32 6s. 4d. in 1459-60,⁹⁵ and only £6 11s. 9½d. in 1470-1.⁹⁶

Half a hide of land in Anstey was, like Wyddial, held before the Conquest by Alward, one of Earl Algar's men, who had the right to sell it. At the time of Domesday it was still, like Wyddial, held in chief by Hardwin de Scales. The mesne tenant was then a certain Payn.⁹⁷ This holding seems to be that which subsequently passed with Wyddial. In 1359 it is described as 100 acres of land in Anstey and Wyddial, which were then held in demesne by Sir Thomas de Scales of Wyddial for suit of court at Anstey Manor.⁹⁸ In 1382-3 the annual rent owed for it to the lord of Anstey was 10s.,⁹⁹ and in 1443 it appears that the suit of court at Anstey was rendered every three weeks.¹⁰⁰ In 1478 the tenants were returned as Robert [John] Harcourt and his wife, who was daughter and co-heiress to Sir John Scales of Wyddial.¹ This holding may possibly be identified with tenements in Anstey held with Wyddial Manor in 1621.²

In 1359 there were said to be eight free tenants of Anstey Manor. These included, as well as Sir Thomas de Scales, John de Ufford, holder of a

knight's fee in Braughing, the heirs of William Tollemache, who held half a knight's fee in Brockley in Suffolk, the heirs of William Claydon, who held a knight's fee in Sandon, co. Essex,³ and the heirs of Martin Chamberley, tenants of half a knight's fee in Rownho or Littlebury in Stanford Rivers in Essex.⁴ These tenants all owed suit of court to Anstey Manor. Of their holdings, Rownho Manor was again said in 1478 to be held freely of Anstey Manor by military service and by suit of court and an annual rent of 6s. 8d.⁵

A windmill appertained to Anstey Manor in 1314.⁶ In 1470-1 it was let for a rent of 36s. 8d.⁷ and it was still held by a lessee in 1508-9.⁸ In 1547 a water-mill in Anstey was granted in fee simple to Sir John Bridges and said to be of the annual value of 20s.⁹

LITTLE ANSTEY occurs in the early 13th century as part of the honour of Richard de Sackville,¹⁰ and perhaps originally formed part of the lordship of Aspenden.¹¹ In 1303 and later it was said to be held of Robert Fitz Walter and his descendants,¹² who seem to have been the overlords of Aspenden. The heir of William de Sackville, successor of Richard, was Richard de Anstey,¹³ and this holding passed with Anstey Manor. In 1303,¹⁴ and again in 1304,¹⁵ it was stated to constitute a knight's fee, and at the latter date it was described as a hamlet of Anstey Manor.¹⁶ In 1314 it consisted of 120 acres of arable land, 2 acres of meadow and 2 acres of pasture.¹⁷ After the 14th century it appears to have been completely merged in Anstey Manor.

BIGGIN MANOR probably consisted of the lands of the hospital of St. Mary Bigging, which existed in 1287 and held land in Anstey parish in 1291.¹⁸ Among their lands was the tenement called Paynes-hall.¹⁹ The chapel and lands of the hospital were granted in 1589 to William Tipper and Robert Dawe,²⁰ the notorious 'fishing grantees.' The estate was acquired by the Provost and fellows of King's College, Cambridge,^{20a} who, according to Salmon, held a court leet and court baron in Biggin Manor in 1728.²¹ Cussans states that in 1873 all manorial rights had been merged in Anstey Manor.²²

BANDONS was the name given in the 15th century to certain copyhold land of Anstey Manor.²³ In 1535 a holding so called was sold by William Hawke of Ely to John Gill, of the family of Wyddial. The estate was increased by further acquisitions of

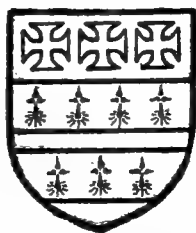

BATHURST. *Sable two bars ermine with three crosses formy or in the chief.*

⁸⁴ Cussans, *Hist. of Herts. Edwinstree Hund.* 58.

⁸⁵ Inform. from Mr. G. F. Beaumont.

⁸⁶ Chan. Inq. p.m. Edw. II, file 34, no. 7.

⁸⁷ Mins. Accts. bdle. 870, no. 7.

⁸⁸ Ibid. bdle. 862, no. 1.

⁸⁹ Ibid. no. 3.

⁹⁰ Ibid. bdle. 870, no. 7.

⁹¹ Ibid. 24 Hen. VII-1 Hen. VIII, no. 61.

⁹² Ibid. bdle. 862, no. 1.

⁹³ Ibid. no. 2.

⁹⁴ Ibid. no. 3.

⁹⁵ Ibid. bdle. 870, no. 4.

⁹⁶ Ibid. no. 7.

⁹⁷ *V.C.H. Herts.* i, 340b.

⁹⁸ Ct. R. portf. 176, no. 124.

⁹⁹ Chan. Inq. p.m. 6 Ric. II, no. 31.

¹⁰⁰ Ct. R. portf. 176, no. 124.

¹ Rentals and Surv. R. 268.

² Chan. Inq. p.m. (Ser. 2), ccccvii, 95.

³ cf. *Cal. Inq. p.m.* 1-9 Edw. III, 206.

⁴ Ct. R. portf. 176, no. 124.

⁵ Rentals and Surv. R. 268. Inquisitions taken in 1330 and in 1478 found that Aspenden Manor (q.v.) was also held of Anstey. See *Cal. Inq. p.m.* 1-9 Edw. III, 210; Chan. Inq. p.m. 18 Edw. IV, no. 28.

⁶ Chan. Inq. p.m. Edw. II, file 34, no. 7.

⁷ Mins. Accts. bdle. 870, no. 7.

⁸ Ibid. 24 Hen. VII-1 Hen. VIII, no. 61.

⁹ *L. and P. Hen. VIII*, xxi (2), 770 (83).

¹⁰ *Testa de Nevill* (Rec. Com.), 270. In the 13th century Little Anstey was apparently a separate parish, for there was a church there (Assize R. 323 [6 & 7 Edw. I], m. 44 d.).

¹¹ Richard de Sackville was tenant of Aspenden (q.v.) in 1086.

¹² *Feud. Aids*, ii, 431; Chan. Inq. p.m. Edw. II, file 34, no. 7; 10 Ric. II, no. 15; *Abbrev. Plac.* (Rec. Com.), 252; *Cal. Inq. p.m.* 1-9 Edw. III, 127.

¹³ See account of Aspenden.

¹⁴ *Feud. Aids*, ii, 431.

¹⁵ *Abbrev. Plac.* (Rec. Com.), 252.

¹⁶ Ibid.

¹⁷ Chan. Inq. p.m. Edw. II, file 34, no. 7.

¹⁸ See account of hospital in article on Religious Houses. The information given by Chauncy (*Hist. Antiq. of Herts.* 108) refers evidently to Bigging in Standon.

¹⁹ Rentals and Surv. R. 268.

²⁰ Pat. 31 Eliz. pt. v, m. 37.

^{20a} *Cal. S. P. Dom.* 1619-23, p. 409.

²¹ Salmon, *Hist. of Herts.* 294.

²² Cussans, op. cit. *Edwinstree Hund.* 58.

²³ Rentals and Surv. R. 268.



ANSTEY CHURCH . 12TH-CENTURY FONT

land in Anstey and Nuthampstead, and in 1870, when it was held by John Williamson Leader of Buntingford, extended to some 500 acres.²⁴

The parish church, the invocation of *CHURCH* which is traditionally to *ST. GEORGE*, stands about a furlong to the south-west of the village on high ground and a little below the crest of the hill. It is built of flint rubble, with dressings of clunch and Barnack stone, and is roofed with lead. All the roofing, except that of the north aisle, dates from a restoration of the 19th century.

The church consists of a chancel 37 ft. by 18 ft., central tower 13 ft. square, north and south transepts, each 19 ft. 6 in. by 18 ft., nave 46 ft. 6 in. by 13 ft., north aisle 9 ft. wide, south aisle 10 ft. wide and south porch. A 14th-century north vestry has been destroyed. The restoration in the 19th century included no structural alterations.

The growth of the fabric is interesting. The earliest church, of the late 12th century, is now

last addition to the church is the south porch, of late 15th-century date. The original 14th-century doorways in the north aisle and north transept are now blocked up, only traces of the latter being visible.

The chancel has a modern east window of 15th-century design in place of the original window, of which only the internal jambs remain. These are shafted, like those of the remaining original windows of the chancel, which are six in number, three on the north and three on the south. All these are traceried and have moulded labels. The seven windows are linked together by a moulded string-course. Those on the north have, as already noted, high external sills to clear the roof of the vestry, which was part of the 14th-century structure. The sill of the south-east window is carried low down, with its jamb shafting, to form the two easternmost of the three seats of the sedilia, whose third seat is formed by a niche in the wall. A large piscina, ranged with the windows and immediately to the east of the sedilia,

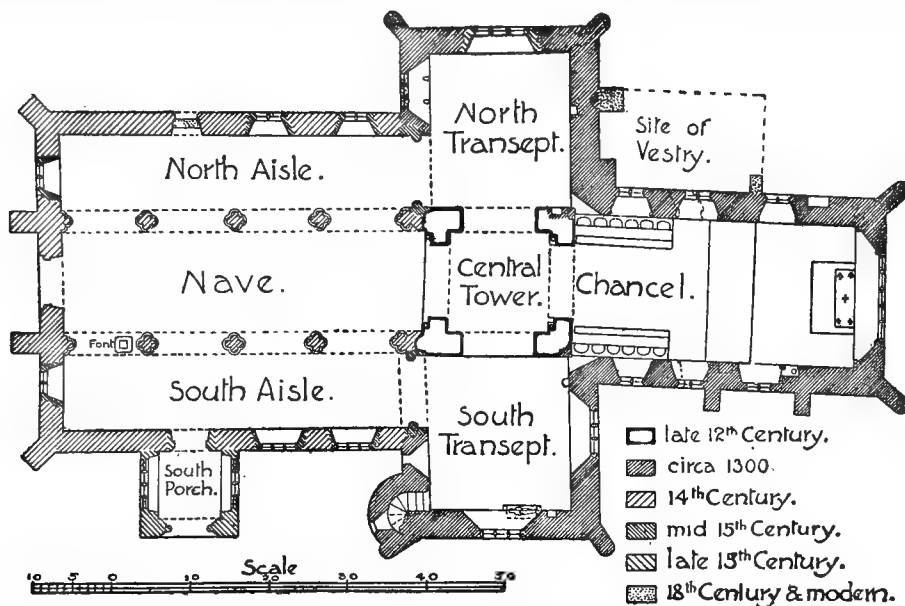

PLAN OF ANSTEY CHURCH

represented by the central tower and about two-thirds of the nave. The original chancel and north and south transepts were superseded at the end of the 13th century and beginning of the 14th, when the present chancel and transepts were built outside them. The destroyed north vestry was built at the same time, as is shown by the fact that the original 14th-century windows on the north side of the chancel have high external sills to clear the roof of the vestry. The carved stalls of the chancel are an unusually early example of woodwork, being contemporary with the chancel itself. The nave was increased to its present length about the middle of the 14th century, and the arcades and aisles were added, and the clearstory pierced with three quatrefoil openings on either side. In the following century the aisle walls were heightened and new windows were inserted. At the same time the arches leading from the aisles to the transepts were altered and the top stage of the tower was added. The

²⁴ Cussans, loc. cit.

is of the same date and has a double drain and a stone shelf. The original splayed door on the north side, with a hood mould and figure corbels, leads to the vestry, and another door on the south side, also of the same date as the rest of the chancel, leads to the churchyard. At the north-west and south-west are squints looking into the two transepts. There are twelve stalls of the early 14th century with plain ends, except one, which is moulded and crocketed. Of the seven carved misericordes three are certainly original, two of the 17th century and two of uncertain date. The stall-fronts have a rusticated arcade in low relief of 17th-century work. On the outside of the chancel at the north-east is a wide and low trefoil-headed niche of the same date as the fabric.

The chancel arch is the easternmost of the four semicircular arches which support the tower. It has the same heavy ringed roll-moulding, jambs with shafts similarly ringed, and simple capitals as the corresponding western arch, while those to north and

A HISTORY OF HERTFORDSHIRE

south are plain. The square formed by their piers is much out of the true, which probably caused the inclination of the chancel to the south and of the south transept to the east. In the second stage of the tower are visible small pointed doorways on the north and south which originally led to rooms over the transepts. Over the eastern arch the high pitch of the 12th-century roof can be traced. The ceiling of the ground stage of the tower is of the 15th century, with moulded beams and wall-plates.

The north transept had originally a north door, which is now blocked up, and a window was inserted over its remains in the late 15th century, probably at the time when the south porch was built and the north doors disused. The original window of three lights in the west wall has been partly blocked and the rear arch altered. A 15th-century moulded arch opens into the aisle. An early 17th-century communion table stands in this transept, and a modern screen contains remnants of a screen of the 15th century. A small piscina at the south-east is of the 14th century. In this transept, as in the south transept, the floor-level of the rooms into which the doors in the first stage of the tower opened is plainly visible. The room over the south transept was also approached by a circular turret stair on the south-west lighted by a cross loop.

The west window of the south transept, a single pointed light, is the only original window remaining. The triple lancet windows on the east and south are restored, and a modern double lancet has been inserted over the south window. A 15th-century arch corresponding to that in the north transept leads to the south aisle. A small image bracket of the 15th century stands at the north-east of the transept.

The nave is of four bays, and has moulded drop arches supported on columns of four clustered shafts with plainly moulded capitals and bases. The clear-story lights are quatrefoils, three on each side, pierced through the 12th-century wall at the same time that the arcades were inserted and the aisles built. Above them runs a heavy string-course. The tracery of the 14th-century west window was altered in the 15th century to the prevailing style. The west door, which is rather wide, is of the 14th century, original to the westward extension of the nave. It has moulded jambs and head.

The north aisle had originally a north door, which is now blocked up, though the jambs and mouldings remain. Its two-light windows are of the 15th century, two on the north and one at the west end. Fragments of white and gold 15th-century glass from the west window are now kept in the vestry. The roof is of the 15th century, with moulded principals. The windows of the south aisle correspond to those of the north, but the south doorway is of later date, belonging to the late 15th century, when the south porch was built.

The 12th-century tower is considerably altered in exterior character. The two lower stages are of the original date, but the bell-chamber has 15th-century

two-light windows with tracery, and the third stage with its battlements, was added in the same period. The small slated needle spire is late. On all four sides the high-pitched 14th-century roof can be traced.

The south porch is of the late 15th century, with two-light windows on the east and west. The interior walls are ornamented with cusped panelling. It has an embattled parapet, and the entrance is a four-centred arch, moulded and shafted.

The font dates from the building of the 12th-century church, and is of a curious type, square with rounded corners and decorated with figures of two tailed mermen holding up cloths.²⁵

The monuments are few. There is the indent of a large cross with a marginal inscription in the north transept, probably of the 15th century. In the south transept, on the south side, stands a tomb with a traceried canopy, now much defaced, and the effigy of an unknown civilian in a long robe, of the early 14th century. The north aisle contains a small mural monument to Ralph Jermin, dated 1646, and in the chancel floor is a slab of Benedict Beaucock of Parlebiens, 1635.

Two chests are in the church, one—iron-bound and once covered with skin—is probably mediaeval; the other, which is plain, is perhaps as old as the 13th century. An embroidered purple velvet altar frontal, dated 1637, is preserved at the rectory together with an early glass bottle containing traces of human blood, which was dug up near the chancel and is probably a reliquary.

Of the six bells in the tower the first is dated 1700, the second and third are of the 18th century, 1778 and 1764 respectively, the fourth and fifth are both dated 1616, and the sixth, which has the inscription 'Sancte Georgie ora pro nobis' with Tudor roses, is probably of the 16th century.

There is no communion plate of a date earlier than the 18th century.

The registers before 1812 are as follows: (i) baptisms, burials and marriages 1540 to 1700; (ii) baptisms and burials 1678 to 1792, marriages 1678 to 1753, and also briefs from 1649; (iii) baptisms and burials 1792 to 1812; (iv) marriages 1754 to 1792; (v) marriages 1793 to 1812.

In the Domesday Survey there is mention of a priest in Anstey.²⁶ In 1291 Anstey Church was of the annual value of £10.²⁷ In the same year the pope granted dispensation to the rector to hold this benefice together with another.²⁸ The advowson was held by Denise wife of Hugh de Vere²⁹ and by her successors lords of Anstey Manor.³⁰ Further benefices were provided to the rectors by the pope in 1330³¹ and 1342,³² and in 1363³³ at the instance of Lady Pembroke. At the time of the Dissolution the rectory was of the clear annual value of £21 13s. 4d.³⁴ The advowson was sold by Sir Roland Lytton to the master and fellows of Christ's College, Cambridge who first presented in 1694³⁵ and are still patrons.

²⁵ A similar font is in St. Peter's Church, Cambridge. The Rev. F. R. Williams states that there is a ledge partly destroyed on the east side of the font, now hidden.

²⁶ *V.C.H. Herts.* i, 321a.

²⁷ *Pope Nich. Tax.* (Rec. Com.), 18.

²⁸ *Cal. Papal Letters*, i, 528.

²⁹ Chan. Inq. p.m. Edw. II, file 34, no. 7.

³⁰ *Ibid.* 3 Hen. V, no. 45; (Ser. 2), cxi, 82; cccxix, 200; ccccxcv, 85; *Cal. Pat.* 1413-16, p. 350; *Recov. R. Mich.* 15 Jas. I, rot. 111; *Feet of F. Div. Co.*

Mich. 1651; *Herts. East.* 1666; *Inst. Bks.* (P.R.O.).

³¹ *Cal. Papal Letters*, ii, 328.

³² *Ibid.* iii, 56. ³³ *Cal. Papal Pet.* 410.

³⁴ *Valor Eccl.* (Rec. Com.), i, 453.

³⁵ *Cussans*, op. cit. *Edwinstree Hund.* 62; *Inst. Bks.* (P.R.O.).



ANSTEY CHURCH: THE CHANCEL



ASPENDEN CHURCH: THE CHANCEL

In 1493 Roger Moos desired in his will to be buried in Anstey Church before the image of St. Stephen, and made a bequest to St. Stephen's altar there,³⁶ which was probably situated in either the north or south transept. Henry Gynne in 1539 made a bequest to St. Stephen's gild in this church.³⁷

At the time of the dissolution of gilds and chantries the church received a rent of 6s. 8d. from a tenement in Barkway, given by William Mores for the keeping of his obit.³⁸

At the same date rents of 6d., 14d. and 12d. were due for the finding of a light in the church, for the maintenance of three lamps, and for that of the lamps in general.³⁹

In 1663 the Rev. Edward CHARITIES Younge, D.D., Dean of the cathedral church of St. Peter, Exeter, by his will directed (among other things) that an annuity of 40s. should be secured for the poor of this parish.

The annuity is paid out of a field called Hadley Field belonging to Baron Dimsdale in the parish of Barkway and is distributed among the poor at Christmas time.

In 1818 John Stallibrass of Barkway by his will directed his executors to invest a sufficient sum of money to produce the clear sum of £10 a year, of which £5 a year should be applied for the benefit of the poor of this parish and £5 a year for the poor of Barkway. The legacy for this parish is represented by £166 13s. 4d. consols with the official trustees, producing £4 3s. 4d. yearly.

It is stated in the Parliamentary returns of 1786 that Arthur Ginn by his will dated in 1705 devised a rent-charge of 6s. 8d. for the poor, issuing out of a farm called Purvis in this parish; also that an annuity of 10s. out of an estate in Anstey and Barkway was given by a donor unknown. This charity has not been paid for many years. The distribution to the poor was formerly made in coals.

ASPENDEN *alias* ASPEDEN WITH WAKELEY

Absedene (xi cent.); Aspehal, Alpsedene, Absedon, Apsdene (xiii cent.); Aspiden, Appeden, Aspdene (xiv cent.); Aspenhalle (xv cent.); Aspesden (xvi cent.).

The parish of Aspenden contains 1,711 acres, more than half of which consists of arable land and about one-third of permanent grass.¹ The country is very bare of woodland. The soil is clay; wheat, barley, beans, oats and peas form the principal crops. The surface level is for the most part about 400 ft. above ordnance datum, but rises to 475 ft. in the north-west and drops to 288 ft. in the valley of the stream called the Bourne, which rises in the south-west of the parish and flows into the Rib. There is a water-mill on the Rib in the east of the parish. The windmill which gave its name to Windmill Hill fell into ruins before the end of last century.²

There are several greens in the parish. Berkesden Green lies on the south-west, Scott's Green on the east and Howe Green³ on the north. The village green itself is part of the common field called Rea Mead⁴ (Remade, xiv cent.). Other place-names occurring in the parish are Perrydon or Parrington (Piridone, xiv cent.),⁵ Russewell Made and Russebroc,⁶ Sneswelle,⁷ Chapmansrat⁸ and Chapmannes Grene⁹ and Monemade Feld.¹⁰

The hamlet of Wakeley, with the site of the church of St. Giles, lies about a mile to the south-west of Aspenden village. Wakeley was an extra-parochial liberty usually included with Aspenden until added to Westmill by Local Government Board Order in 1883.

Ermine Street forms part of the eastern boundary of Aspenden, and the market town of Buntingford, which is on this road, lies partly within the parish.

At Buntingford a road branches west from Ermine Street¹¹ and for some distance forms the boundary line between Aspenden and Throcking, leading finally to the market town of Biggleswade.

The village of Aspenden is situated a little to the west of Ermine Street, along the valley of the Bourne. The church of St. Mary and manor-house of Aspenden Hall lie close together on the north side of the village street. Aspenden Hall is a modern mansion of brick covered with cement. The old Hall was pulled down about 1850 and the late 17th-century oak panelling refixed in the hall of the present mansion. Chauncy gives a picture of the old Hall built by William and Ralph Freeman at the beginning of the 17th century. When it was being demolished many carved stones were discovered, from which it was supposed that it was built out of the ruins of Wakeley or Berkesden Church. The Hall was used as a school at the beginning of the 19th century. Among those who were educated there during the eleven years of the school's existence were Thomas Babington, who became Lord Macaulay,¹² William Wilberforce, the eldest son of Bishop Wilberforce,¹³ and Henry Malden, who was afterwards Professor of Greek at University College.¹⁴

The rectory which stands a short distance to the south of the church is a timber-framed building covered with plaster; the front upper story projects. The ceiling of the dining room has moulded oak beams and joists with splayed and stopped arrises, probably of late 16th-century date. The house has been much modernized. About forty years ago there was discovered in one of the walls a double recess, trefoil-headed, resembling a piscina. The village school stands to the east of the church. On the same

³⁶ P.C.C. Wills, 26 Doggett.

³⁷ Ibid. 18 Crumwell.

³⁸ Chant. Cert. 27, no. 30.

³⁹ Ibid. no. 37.

¹ Statistics from Bd. of Agric. (1905).

² See Clutterbuck, op. cit. iii, 357; *East Herts. Arch. Soc. Trans.* iii, 104.

³ This name occurs in the 16th century (*Herts. Gen. and Antiq.* i, 336).

⁴ Anct. D. (P.R.O.), A 5223; cf. Refeld mentioned in *ibid.* A 1112.

⁵ Ibid. A 5223.

⁶ Ibid. A 5215, 1006; cf. Rushden, *Osdey Hund.*

⁷ Ibid. A 1123.

⁸ Ibid. A 5252, 5253.

⁹ Ibid. A 5254.

¹⁰ Ibid. A 716.

¹¹ The present road branches off at

Buntingford, but evidently the older line of road followed the course of the foot-path which branches off a little further north and is coincident with the line of the parish boundary which joins the present road in Thistley Vale.

¹² *Dict. Nat. Biog.*

¹³ Cussans, op. cit. *Edwinstree Hund.*

¹⁴ *Dict. Nat. Biog.*

A HISTORY OF HERTFORDSHIRE

side of the road further east is a 17th-century timber and plaster cottage with overhanging story.

Seth Ward, successively Bishop of Exeter and Salisbury, was born at Aspenden in 1617, and resided for some time at Aspenden Hall as tutor to the sons of Ralph Freeman. After he had obtained preferment he showed his attachment to his native place by building almshouses at Buntingford in 1684, three years before his death.¹⁵

Henry Pepys, D.D., Bishop of Worcester (1783–1860), was rector of Aspenden from 1818 to 1827.¹⁶

The manor of *ASPENDEN* *alias* *MANORS ASPENDEN HALL* was held in the reign of Edward the Confessor by Aldred, the king's thegn. After the Norman Conquest it became part of the possessions of Eudo Dapifer, son of Hubert de Ryes, and was held of him by Richard de Sackville.¹⁷ Eudo died without issue in 1120, and the overlordship probably passed through his sister

to Nicholas de Anstey,¹⁸ whose only child and heiress Denise took them in marriage to Warine de Monchensey.¹⁹

By the beginning of the 13th century a subfeoffment of the manor had been made to the family of Tany.²⁰ Peter de Tany, who was Sheriff of Essex and Herts. in 1236,²¹ died before 1255, and his lands descended to his son Richard de Tany,²² who died in 1270,²³ then to the latter's son Sir Richard de Tany,²⁴ who died about 1295.²⁵ Roger de Tany, son of Sir Richard,²⁶



TANY. Or six eagles sable.

who died in 1301, left a son Lawrence, aged two, as his heir.²⁷ Lawrence de Tany died without issue in 1317 and Aspenden passed to his sister Margaret.²⁸

After this date there is no further trace of the Tany family holding any rights in Aspenden. Their tenancy was already a mesne one in 1255, when the manor was held as a knight's fee of Richard de Tany by Ralph Fitz Ralph,²⁹ whose father Ralph son of Fulk had held land in Aspenden.³⁰

Ralph Fitz Ralph apparently forfeited his lands, for his wife Maud received a grant of certain of them, including 60 acres in Aspenden, in 1266.³¹ By 1303 Aspenden had descended to Ralph's son William Fitz Ralph.³² In 1317³³

and 1324³⁴ the manor is returned as held by William Fitz Ralph, and in 1340 his son William Fitz Ralph settled it on himself and his wife Sybil.³⁵ This William died before 1356, when his heirs were his daughters Margaret and Sybil, who were minors.³⁶ The manor of Aspenden, however, descended to a William Fitz Ralph, who in 1383 granted all his

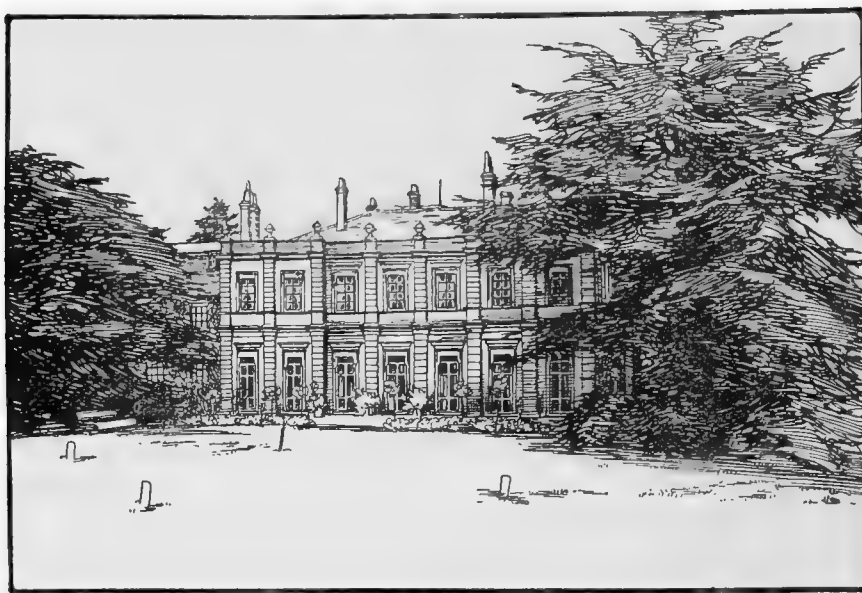

ASPENDEN HALL : GARDEN FRONT

Albreda to the Valognes family and thence to the Fitz Walters.¹⁸

Richard de Sackville, who was tenant of this manor in 1086,¹⁹ was succeeded by William de Sackville,²⁰ who was probably his son. On the death of William his lands descended to his nephew Richard de Anstey.²¹ By 1224 the Anstey lands in Aspenden had descended

¹⁵ See *Dict. Nat. Biog.*; *East Herts. Arch. Soc. Trans.* iii, 220. A fuller notice of Seth Ward is given under Buntingford.

¹⁶ *Dict. Nat. Biog.*

¹⁷ *V.C.H. Herts.* i, 329a.

¹⁸ See *Testa de Nevill* (Rec. Com.), 270. It is possible that Robert Fitz Walter held this fee during the minority of the heir by grant of the king, as he apparently did Anstey; but, on the other hand, the overlordship of Little Anstey, which seems to have been originally part of the lordship of Aspenden, is several times returned as vested in the Fitz Walters.

¹⁹ *V.C.H. Herts.* loc. cit.

²⁰ *V.C.H. Essex*, i, 379.

²¹ *Ibid.*; *Cart. Mon. S. Johannis de Colecestria* (Roxburghe Club), i, 163–5.

²² Fine R. 8 Hen. III, m. 5.

²³ See *Abbrev. Plac.* (Rec. Com.), 144. For pedigree of the Anstey family see the manor of Anstey.

²⁴ See *Abbrev. Plac.* (Rec. Com.), 144. The overlordship descended with the manor of Anstey.

²⁵ P.R.O. *List of Sheriffs*, 43.

²⁶ See *Abbrev. Plac.* (Rec. Com.), 144.

²⁷ *Cal. Inq. p.m. Hen. III*, 248.

²⁸ De Banco R. 44, m. 22; Assize R. 325.

²⁹ Chan. Inq. p.m. 21 Edw. I, no. 14.

This inquisition does not give the date of Richard's death, but he was living as late as 1295. See Inq. a.g.d. file 25, no. 13.

³⁰ Chan. Inq. p.m. 24 Edw. I, no. 14.

³¹ *Ibid.* 29 Edw. I, no. 38. See *Feud. Aids*, ii, 431.

³² *Cal. Inq. p.m. 10–20 Edw. II*, 69.

³³ *Abbrev. Plac.* (Rec. Com.), 144.

³⁴ See Anct. D. (P.R.O.), A 7510.

³⁵ *Cal. Pat.* 1258–66, p. 526.

³⁶ *Feud. Aids*, ii, 431.

³⁷ *Cal. Inq. p.m. 10–20 Edw. II*, 69.

³⁸ *Ibid.* 332.

³⁹ Feet of F. Herts. 14 Edw. III, no. 210.

⁴⁰ *Cartae Antiquae of Lord Willoughby de Broke* (ed. J. Harvey Bloom), ii, 7.

right in it to his son William,⁴¹ who died before 1426,⁴² when his heirs, John Hughessen of Ashwell and Elizabeth wife of John Clerke, senior, of Ardeley, conveyed all their right to John Clerke, citizen of London, and Thomas Clerke, clerk.⁴³ In January 1450-1 the manor was held by Thomas Smyth, Joan Wendy and Thomas Pilche, who sold it in that year to Ralph Jocelyn, citizen and draper of London, and Philippa his wife.⁴⁴ Ralph was son of Geoffrey Jocelyn of Sawbridge-worth. In 1464 and 1477 he was Lord Mayor of London,⁴⁵ and in 1465 was made a knight of the Bath.⁴⁶ On the death of his wife Philippa he married Elizabeth daughter of William Barley. He left no issue at his death in 1478.⁴⁷

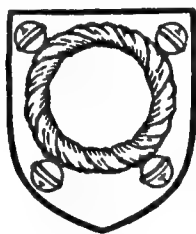

JOCKLYN. *Azure a twisted wreath of argent and sable with four hawks' bells or attached thereto.*

The manor of Aspenden had been settled on his wife Elizabeth,⁴⁸ who married as her second husband Sir Robert Clifford,⁴⁹ a prominent supporter of the Perkin Warbeck conspiracy, who afterwards obtained his pardon and a substantial reward by betraying the names of his fellow-conspirators. He died in 1508⁵⁰ and his widow Dame Elizabeth Clifford about 1526.⁵¹ In 1527 their son Thomas Clifford conveyed the manor to trustees for Agnes Marsh, widow of Thomas Marsh, citizen and mercer of London,⁵² who died seised in 1528, when Aspenden descended to her son William Byrche.⁵³

In 1537 the manor was held by Edward Viscount Beauchamp, afterwards Duke of Somerset and Protector, and Anne his wife, daughter of Sir Edward Stanhope, in her right, and they conveyed it to Thomas Pope, treasurer of the Court of Augmentations.⁵⁴ This may have been in trust for Thomas Lord Audley, for he held at his death in 1544.⁵⁵ It then apparently came to the king, who mortgaged it to John Clerke and others.⁵⁶ It was redeemed shortly afterwards, and in 1549 it was granted on a sixty years' lease to John Philpot, groom of the king's privy chamber.⁵⁷ In 1553 John Philpot obtained entire possession of the manor,⁵⁸ and in March 1579-80 he granted the reversion of it after his death to Henry Sadleir and Dorothy his wife.⁵⁹ Dorothy probably died before 1604, for in that year Henry Sadleir with his wife Ursula conveyed the

manor to Thomas Crouch and George Freeman,⁶⁰ apparently in trust for William and Ralph Freeman, who married the two daughters of John Crouch,⁶¹ and to whom in 1607 Henry and Ursula confirmed all their rights in the manor, with remainder to the heirs of William.⁶² William and Ralph were merchants of London and lived together at Aspenden Hall.⁶³ Ralph Freeman, who was Lord Mayor of London, died in 1634. In 1623 William died and his son Ralph succeeded him.⁶⁴ He held the manor⁶⁵ until his death in 1665, retiring from all public life during the Civil War.⁶⁶ His son and heir Ralph was a justice of the peace and deputy lieutenant of the county.⁶⁷ During his tenure

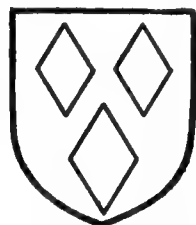

FREEMAN of Aspenden. *Azure three lozenges argent.*

of the manor⁶⁸ he cased Aspenden Hall in brick. He died in 1714 and was succeeded by his son Ralph,⁷⁰ M.P. for the county in 1722, who died in 1742.⁷¹ He left three sons, William, Catesby, who died unmarried the same year as his father, and Ralph Freeman, D.D.⁷² William died in 1749, when the manor passed to Dr. Ralph Freeman,⁷³ who had been presented to the rectory of Aspenden in 1743.⁷⁴ At his death in 1772 he left no issue and Aspenden passed by the terms of his will to Philip Yorke, the son of the Hon. Charles Yorke and Catherine the only daughter and heiress of Ralph's brother William Freeman.⁷⁵

Philip Yorke sold the manor in 1785 to John Boldero,⁷⁶ who already held Aspenden Hall.⁷⁷ John Boldero died in 1789.⁷⁸ His son Charles Boldero left no issue, and Aspenden passed to his nephew Sir Henry Lushington, bart., son of Hester Boldero, who had died in 1830.⁷⁹ Sir Henry was succeeded in 1863 by his son Sir Henry Lushington, bart.,⁸⁰ who died in 1897. His son Sir Henry Lushington only survived him a year, and Aspenden then descended to Maj. Sir Arthur Patrick Douglas Lushington, bart.,⁸¹ the present lord of the manor.



LUSHINGTON. *Or a fesse wavy between three lions' heads razed vert with three ermine tails or on the fesse.*

⁴¹ Anct. D. (P.R.O.), B 154.

⁴² See Close, 6 Hen. VI, m. 14.

⁴³ Ibid.

⁴⁴ Anct. D. (P.R.O.), B 157.

⁴⁵ Stowe, *Survey of London* (ed. J. Strype), v, 122.

⁴⁶ Shaw, *Knights of England*, i, 134; see Holinshed, *Chron. of Engl.* ii, 690, 702 for further facts about him.

⁴⁷ *Visit. of Essex* (Harl. Soc.), 228; Chan. Inq. p.m. 18 Edw. IV, no. 28.

⁴⁸ Chan. Inq. p.m. 18 Edw. IV, no. 28.

⁴⁹ *Visit. of Essex* (Harl. Soc.), 228.

⁵⁰ M. I. in church.

⁵¹ Her will was proved in 1526. See P.C.C. 9 Porch.

⁵² See Feet of F. Herts. Trin. 19 Hen. VIII; Chan. Inq. p.m. (Ser. 2), li, 29; Ct. R. (Gen. Ser.), portf. 176, no. 126.

⁵³ Chan. Inq. p.m. (Ser. 2), li, 29.

⁵⁴ Feet of F. Herts. East. 29 Hen. VIII.

⁵⁵ See *L. and P. Hen. VIII*, xix (2), g. 166 (56).

⁵⁶ Ibid. (1), 891 (iv).

⁵⁷ *Acts of P.C.* 1547-50, p. 389.

⁵⁸ Ibid. 1552-4, p. 287; Pat. 7 Edw. VI, pt. xi, m. 29.

⁵⁹ Pat. 22 Eliz. pt. ix, m. 24; Feet of F. Herts. East. 22 Eliz.

⁶⁰ Feet of F. Herts. East. 2 Jas. I.

⁶¹ M. I.

⁶² Feet of F. Herts. Trin. 5 Jas. I.

⁶³ Chauncy, *Hist. Antiq. of Herts.* 122.

⁶⁴ Ibid.

⁶⁵ See Feet of F. Div. Co. Hil. 13 & 14 Chas. II.

⁶⁶ Chauncy, loc. cit.

⁶⁷ Ibid.

⁶⁸ See Feet of F. Div. Co. Trin. 28 Chas. II; Hil. 11 Will. III.

⁶⁹ Chauncy, loc. cit.

⁷⁰ Clutterbuck, *Hist. and Antiq. of Herts.* iii, 348.

⁷¹ Cussans, op. cit. *Braughing Hund.* 196; M. I. Ralph Freeman's name appears in the Inst. Bks. (P.R.O.) as presenting to the rectory in 1743, but this must be a mistake for William Freeman his son.

⁷² Cussans, loc. cit. See Hamells in *Braughing Hundred.*

⁷³ See *Recov. R. East.* 23 Geo. II, rot. 323.

⁷⁴ Clutterbuck, op. cit. iii, 351.

⁷⁵ See Close, 25 Geo. III, pt. xxii, no. 8.

⁷⁶ Ibid. no. 8, 9.

⁷⁷ Ibid.; Clutterbuck, loc. cit.

⁷⁸ M. I. in church.

⁷⁹ G.E.C. *Complete Baronetage*, v, 267.

⁸⁰ Ibid.

⁸¹ Ibid.

A HISTORY OF HERTFORDSHIRE

In the time of Edward the Confessor the manor of *BERKESDEN* (Berchedene, xi cent.; Berchedena, Barchedene, Berchesdene, Berkedene, xii cent.; Borkeden, xv cent.) was held by Alward, a man of Earl Harold.⁸² After the Norman Conquest it became part of the possessions of Count Eustace of Boulogne,⁸³ and remained attached to the honour of Boulogne.⁸⁴

The earliest tenant in fee of this manor was Robert, who was holding under Count Eustace in 1086.⁸⁵ At this date there was a mill on the manor worth 2s. 8d.⁸⁶ Robert appears to be identical with Robert Fitz Rozelin, who held Reed under the count,⁸⁷ and to have been succeeded here as there by the Trikets, who were probably his descendants.⁸⁸ The first of these known to have held the manor of Berkesden was Hugh Triket,⁸⁹ who was living about 1150.⁹⁰ He was succeeded by Ralph Triket, who had two sons Stephen and Robert.⁹¹ Stephen, with his mother Armengerda, granted land in Berkesden to the canons of Holy Trinity in exchange for other lands from them to hold in fee.⁹² He died before 1197-8 and was succeeded by his brother Robert, who quitclaimed the land in Berkesden held of Holy Trinity by Stephen Triket, and was received into their 'brotherhood.'⁹³ He was also granted by the canons a corrody for a servant for life of a loaf, a dish of pottage, and one of meat or fish and two gallons of ale daily, with 3s. a year for clothes.⁹⁴ By 1212 Berkesden had descended to Simon Triket.⁹⁵

Under the Trikets the manor was held by the Ansteys.⁹⁶ About the middle of the 12th century Hubert de Anstey joined with his son Richard de Anstey in granting it to Gervase de Cornhill,⁹⁷ who after holding it for a night and a day granted it to the Prior and canons of Holy Trinity or Christ Church, London.⁹⁸ The manor of Berkesden remained with the canons of Holy Trinity⁹⁹ until their dissolution in 1531.¹⁰⁰ In 1535 Henry VIII granted the manor to Sir Edward Seymour, afterwards the Protector Somerset, and Anne his wife,¹ who in the following year conveyed it to Sir Thomas Audley, kt., chancellor of England.² This was probably in trust for the king, to whom Audley quitclaimed his right two years later.³ It remained with the Crown until 1544, when Henry VIII mortgaged it with other lands to the Mayor and aldermen of London.⁴

Berkesden afterwards apparently became the property of Sir Andrew Judde, kt., one of the aldermen,⁵ for after his death in 1558⁶ it was held for life by his widow Lady Mary Judde, who was holding as late as January 1584-5.⁷ In 1565 Richard Judde, a younger son of Sir Andrew Judde,⁸ alienated all right in the manor to Thomas Smyth and Alice his wife.⁹ In 1574 the manor seems to have been in the hands of William Morley and to have been conveyed by him to Edward Halfhide,¹⁰ who in 1579 sold the Westmill part of the property to John Brograve,¹¹ and in 1581 sold the manor to Andrew Grey.¹² On the death of Andrew Grey in 1615 Berkesden descended to his daughter Mary wife of Sir Gilbert Kniveton, kt.,¹³ who sold it in 1618 to Sir Stephen Soame, kt., of Thurlow, co. Suffolk.¹⁴ At his death in 1619 it apparently descended to his younger son Sir Stephen Soame, kt.,¹⁵ who died seised in 1640, when it descended to his son Peter, aged five and a half years.¹⁶ Peter succeeded his cousin as baronet in 1686.¹⁷ He died in 1693 or 1694,¹⁸ and his lands and title were inherited by his son Peter, who died in 1709.¹⁹ His son Sir Peter Soame, bart.,²⁰ sold the manor in 1782 to John Boldero of Aspenden Hall,²¹ who in 1785 purchased the manor of Aspenden (q.v.). From this date the two manors have descended together.

In 1086 a virgate of land in Berkesden was held by Peter and Theobald of Hardwin de Scales, who claimed to have it by an exchange with the Bishop of Bayeux. It was also claimed by Count Alan of Brittany.²² It is probable that Hardwin retained possession of this land and attached it to his neighbouring manor of Wakeley (q.v.).

In the time of King Edward the Confessor *WAKELEY* (Wackelei, xi cent.; Wakeleia, xii cent.; Walkeleya, xiii cent.) was divided into three holdings of 40 acres each, held respectively by Alward, a man of Earl Harold,²³ Edric, a man of Earl Algar,²⁴ and by Eddeva the Fair, the last holding only being styled

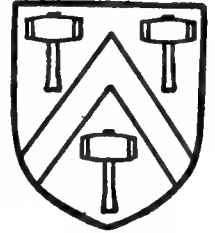

SOAME, baronet.
Gules a chevron between
three mallets or.

⁸² *V.C.H. Herts.* i, 321b.

⁸³ *Ibid.*

⁸⁴ See Anct. D. (P.R.O.), A 11967, 5420; *Liber Niger Scacc.* (ed. T. Hearne), i, 389; *Red Bk. of Exch.* (Rolls Ser.), ii, 502, 581; *Testa de Nevill* (Rec. Com.), 270, 274.

⁸⁵ *V.C.H. Herts.* loc. cit.

⁸⁶ *Ibid.*

⁸⁷ *Ibid.*

⁸⁸ Dugdale, *Mon.* vi, 152. See manor of Corneybury in Wyddial.

⁸⁹ *Liber Niger Scacc.* (ed. T. Hearne), i, 389, 390.

⁹⁰ See Dugdale, loc. cit.

⁹¹ Anct. D. (P.R.O.), A 500, 5915.

⁹² *Ibid.* A 500.

⁹³ *Ibid.* A 5915.

⁹⁴ *Ibid.* A 5889.

⁹⁵ *Red Bk. of Exch.* (Rolls Ser.), ii, 581; *Testa de Nevill* (Rec. Com.), 274, 275.

⁹⁶ See *Liber Niger Scacc.* (ed. T. Hearne), i, 389, 390.

⁹⁷ Anct. D. (P.R.O.), A 5420.

⁹⁸ *Ibid.* A 11967, 202. The canons

were afterwards said to hold it of the gift of Richard de Anstey (Dugdale, *Mon.* vi, 153). The Ansteys appear as mesne lords as late as 1303 (*Red Bk. of Exch.* [Rolls Ser.], ii, 581; *Testa de Nevill* [Rec. Com.], 270, 274; *Feud. Aids*, ii, 439).

⁹⁹ See *Pope Nich. Tax.* (Rec. Com.), 51b; *Feud. Aids*, ii, 432, 446, 453; Anct. D. (P.R.O.), A 1071.

¹⁰⁰ Dugdale, *Mon.* vi, 150.

¹ *L. and P. Hen. VIII*, viii, g. 481 (13).

² Feet of F. Herts. Trin. 28 Hen. VIII.

³ D. of Purchase and Exchange, box E, no. 5, m. 6. Audley was apparently only a go-between, for the king is said to have purchased the manor of Sir Thomas [Edward?] Seymour (*L. and P. Hen. VIII*, xix [2], g. 166 [51]).

⁴ *L. and P. Hen. VIII*, xix (1), 891; (2), g. 166 (51).

⁵ *Ibid.*

⁶ See Chan. Inq. p.m. (Ser. 2), cxvi, 91. Berkesden is not mentioned in this inquisition.

⁷ See *ibid.* ccvii, 70.

⁸ See *ibid.* cxvi, 91.

⁹ Pat. 7 Eliz. pt. vi; Feet of F. Herts. Hil. 8 Eliz.

¹⁰ *Recov. R. Trin.* 1574, rot. 759.

¹¹ Pat. 21 Eliz. pt. vi, m. 29.

¹² Close, 23 Eliz. pt. vii; *ibid.* pt. xxiii; see Chan. Inq. p.m. (Ser. 2), cccxlvii, 75.

¹³ Chan. Inq. p.m. (Ser. 2), cccxlvii, 75.

¹⁴ Feet of F. Herts. Trin. 16 Jas. I; see Chan. Proc. (Ser. 2), bde. 324, no. 34.

¹⁵ G.E.C. *Complete Baronetage*, s.v. Soame, iv, 136.

¹⁶ Chan. Inq. p.m. (Ser. 2), ccccxciv, 128; see Feet of F. Div. Co. Hil. 1655; *Recov. R. Hil.* 1655, rot. 106.

¹⁷ G.E.C. loc. cit.

¹⁸ *Ibid.*

¹⁹ *Ibid.*

²⁰ *Ibid.*; see *Recov. R. Hil.* 31 Geo. II, rot. 42.

²¹ Clutterbuck, *Hist. and Antiq. of Herts.* iii, 351.

²² *V.C.H. Herts.* i, 340b.

²³ *Ibid.* 321a.

²⁴ *Ibid.* 340b.

a manor.²⁵ After the Norman Conquest Alward's land had passed to Count Eustace of Boulogne, and was held of him by Robert.²⁶ This holding cannot be traced after this time, and it was probably appurtenant to the neighbouring manor of Berkesden (q.v.), which Robert held of the count.

Eddeva the Fair's lands in Wakeley became part of the possessions of Count Alan of Brittany and were held of him by Ralph.²⁷ Count Alan held also the manor of Munden,²⁸ and the overlordship of the manor of Wakeley appears to have descended with that manor until the end of the 13th century, when it was held by the Furnivals, lords of the manor of Munden, at which suit of court was owed.²⁹ Ralph, the tenant in fee of this holding in 1086, seems to be identical with Ralph Pinel the predecessor of the Lanvalleys,³⁰ for in 1194 his lands in Wakeley had descended to William de Lanvalley.³¹ The Lanvalleys appear to have subenfeoffed these lands to the Fitz Ralphs before this date,³² and these lands probably were amalgamated with the Fitz Ralphs' other holding in Wakeley. This was the fee which in Saxon times was held by Edric. In 1086 it formed part of the possessions of Hardwin de Scales, and was held of him by Theobald,³³ ancestor of the Fitz Ralphs. At the beginning of the 13th century Hardwin's descendants were holding in service in Wakeley,³⁴ but after this there is no further record of their tenure here. Theobald, who was holding the manor of Hardwin in 1086, appears to have had a son Fulk, who was succeeded by his son Theobald.³⁵ He was holding the manor of Wakeley with his wife Amphyllis in 1194 with reversion to his son Fulk and Eleanor his wife.³⁶ In 1277 Ralph Fitz Ralph of Broadfield (grandson of Fulk) was lord of Wakeley, but by this time a tenant had been subenfeoffed.³⁷

Ralph Muschet was holding the manor of Wakeley of Ralph Fitz Ralph in 1277.³⁸ His father Richard Muschet had also held land in Wakeley.³⁹ Ralph's heirs appear to have been Joan wife of Luke de Tany and Sybil wife of John de Montfort, who were holding the advowson in 1308.⁴⁰ In 1309 Joan and her husband conveyed all their right in the manor to Robert de Kendale and his wife Margaret,⁴¹ and in 1311 Robert presented to the church jointly with Ralph Muschet's widow Joan.⁴² Robert was granted free warren in his manor of Wakeley in

March 1317-18,⁴³ and in 1320 he received a quitclaim of all right in the manor from Sybil and John de Montfort.⁴⁴ Robert died in 1330.⁴⁵ His wife Margaret held the manor for her life,⁴⁶ and on her death in 1347⁴⁷ it descended to their son Edward de Kendale. He died in January 1372-3⁴⁸ and his wife Elizabeth in 1375.⁴⁹ Her eldest son Edward having died without issue earlier in the same year, Wakeley descended to her second son Thomas Kendale, clerk,⁵⁰ who barely survived his mother a week, and the manor then passed to his sister Beatrice the wife of Robert Turk.⁵¹

Beatrice appears to have died before her husband, who in 1400 died seised of the manor, which descended to his only daughter Joan the wife of John Waleys.⁵² John Waleys died in 1418⁵³ and Joan in 1420, when her Hertfordshire property, including Wakeley, descended to her four daughters and co-heirs, Beatrice the wife of Reginald Cokayn, Joan the wife of Robert Leventhorp, Agnes Waleys and Joan Waleys.⁵⁴

In 1428 Reginald Cokayn and the other heirs (unnamed) were holding Wakeley,⁵⁵ but the manor ultimately passed to the second daughter Joan, who married secondly Nicholas Morley.⁵⁶ Joan Morley appears to have died before 1452, but her husband was then still living.⁵⁷ He died apparently before 1454, for in that year Richard Morley presented to the church.⁵⁸ The manor afterwards came to Robert Morley, the son of Nicholas and Joan.⁵⁹ He died in 1516; his son Thomas had died before him, and Wakeley descended to his grandson Thomas Morley, a minor.⁶⁰ He held the manor until his death in January 1557-8.⁶¹ His heir was his son Thomas,⁶² but he appears to have

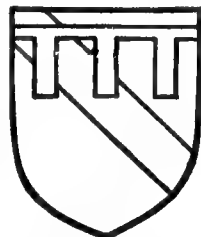

KENDALE. *Argent a bend vert and a label gules.*



MORLEY. *Sable a fleur de lis or coming out of a leopard's head argent.*

²⁵ *V.C.H. Herts.* i, 320. This arrangement suggests a sub-division among brothers; see *ibid.* 289.

²⁶ *Ibid.* 321a.

²⁷ *Ibid.* 320.

²⁸ *Ibid.* 319.

²⁹ Feet of F. Herts. 6 Edw. I, no. 70; see *Assize R.* 323, m. 1 d.; *Chan. Inq. p.m.* 49 Edw. III (1st nos.), no. 74; see *V.C.H. Herts.* iii, 124.

³⁰ See *Morant, Hist. of Essex*, i, 440.

³¹ *Abbrev. Plac. (Rec. Com.)*, 2.

³² *Ibid.*

³³ *V.C.H. Herts.* i, 340b.

³⁴ *Abbrev. Plac. (Rec. Com.)*, 98. For pedigree of the Scales see manor of Wyddial.

³⁵ *Dugdale, Mon.* v, 369. See manor of Broadfield, Odsey Hundred, for descent of this family.

³⁶ *Abbrev. Plac. (Rec. Com.)*, 2.

³⁷ Feet of F. Herts. 6 Edw. I, no. 70. For the overlordship of the Fitz Ralph family see *Cal. Inq. p.m.* 1-9 Edw. III, 209; *Chan. Inq. p.m.* 2 Hen. IV, no. 36.

For descent of the Fitz Ralphs see the manor of Aspenden.

³⁸ Feet of F. Herts. 6 Edw. I, no. 70.

³⁹ See *Anct. D. (P.R.O.)*, A 5194, 7214.

⁴⁰ *Clutterbuck, Hist. and Antiq. of Herts.* iii, 349.

⁴¹ Feet of F. Herts. 2 Edw. II, no. 28. Edward de Kendale, who presented to the church in 1309 (*Clutterbuck, loc. cit.*), was probably holding in trust for Robert.

⁴² *Clutterbuck, loc. cit.*

⁴³ *Cal. Chart. R.* 1300-26, p. 379.

⁴⁴ Feet of F. Herts. 14 Edw. II, no. 332.

⁴⁵ *Cal. Inq. p.m.* 1-9 Edw. III, 209.

⁴⁶ *Ibid.*; see *Clutterbuck, loc. cit.*

⁴⁷ *Chan. Inq. p.m.* 21 Edw. III, no. 19.

⁴⁸ *Ibid.* 47 Edw. III (1st nos.), no. 20.

⁴⁹ See *ibid.* 49 Edw. III (1st nos.), no. 74.

⁵⁰ *Ibid.*

⁵¹ *Ibid.* no. 95; see Feet of F. Div. Co. 50 Edw. III, no. 146.

⁵² *Chan. Inq. p.m.* 2 Hen. IV, no. 36.

⁵³ *Ibid.* 6 Hen. V, no. 11.

⁵⁴ *Ibid.* 3 Hen. VI, no. 35; see *De Banco R.* 651 (2 Hen. VI), m. 128.

⁵⁵ *Feud. Aids*, ii, 446.

⁵⁶ *Suss. Arch. Coll.* xx, 60; *Visit. of Sussex (Harl. Soc.)*, 47; *Berry, Suss. Gen.* 173.

⁵⁷ See Feet of F. Herts. 31 Hen. VI, no. 161.

⁵⁸ *Clutterbuck, op. cit.* iii, 349. Richard Morley is not mentioned in any of the pedigrees. He appears to be the Richard Morley called in 1470 'late of Aspenden, alias late of London' (*Cal. Pat.* 1467-77, p. 203).

⁵⁹ *Suss. Arch. Coll.* xx, 60; *Visit. of Sussex (Harl. Soc.)*, 47; *Berry, loc. cit.*

⁶⁰ *P.C.C.* 23 Holder; *Chan. Inq. p.m. (Ser. 2)*, xxxi, 98.

⁶¹ *Chan. Inq. p.m. (Ser. 2)*, xxiv, 160.

⁶² *Ibid.*

A HISTORY OF HERTFORDSHIRE

died without issue soon after his father, and Wakeley came to a younger son William Morley.⁶³ In 1574 William sold the manor to Edward Halfhide,⁶⁴ who with his wife Amy conveyed it to Edward Baesh in 1574-5.⁶⁵ In 1577 Edward Baesh and Jane his wife re-conveyed the manor to Halfhide,⁶⁶ who in 1577-8 sold it to Edward Hyde.⁶⁷ In 1610 John Hyde sold it to William Dodi.⁶⁸ By 1623 it had come into the possession of Samuel Bridger and his wife Mary,⁶⁹ who held in Mary's right, and they in 1625 sold it to Ralph Freeman, lord of the manor of Aspenden.⁷⁰

From this time the manor of Wakeley descended with the manor of Aspenden (q.v.) until 1785, when Philip Yorke sold the manor of Aspenden, but retained Wakeley in his own hands.⁷¹ In 1790 Philip Yorke succeeded his uncle as third Earl of Hardwicke.⁷² He died in 1834 and the manor of Wakeley descended to his eldest daughter Anne the wife of John Savile third Earl Mexborough of Lifford.⁷³ She died in 1870, and Wakeley descended to her grandson the Hon. John Horace Savile, who succeeded his father as fifth Earl of Mexborough in 1899⁷⁴ and is the present lord of the manor. All manorial rights, however, have long since lapsed, and the estate consists merely of a farm-house and a few cottages.

The manor of *TANNIS* (Tanneys, xv cent.; Tawnys, xvi cent.; Tawney, Townis, xvii cent.) was held in 1424 with the manor of Wakeley by the four daughters and co-heirs of Joan Waleys.⁷⁵ The name of the manor suggests some connexion with the family of Tany, and it seems probable that it was either composed of lands which they held besides the manor of Aspenden or that it was the part of Wakeley which for a short time was held by Joan and Luke Tany, and that during that time it acquired a separate name. From 1424 it descended with the manor of Wakeley (q.v.) until Hilary 1577-8, when Edward Halfhide, lord of the manors of Tannis and Wakeley, sold Wakeley⁷⁶ but retained Tannis. Edward Halfhide also acquired the manor of Berkesden, and in 1581 he sold the manors of Berkesden and Tannis to Andrew Grey.⁷⁷ From this date Tannis has descended with Berkesden (q.v.). No manorial rights now exist. There is a farm-house called Tannis Court to the north-east of Berkesden Green, but the older house stands a quarter of a mile away from it and has the remains of a homestead moat surrounding it. There was a house here in

1569 when a detailed inventory was taken of all its contents.⁷⁸ This inventory was signed by Edward Halfhide,⁷⁹ who appears to have lived in the house, although he did not acquire the manor of Tannis from the Morleys until 1574.⁸⁰ Evidently Sir Edward Capell, Edward Halfhide's father-in-law, resided here, for in his will he refers to 'the hangings in my chamber at Tannes commonly called my lady Katherine's chamber.'⁸¹ The lady who gave her name to the room was possibly Katherine Morley, mother of Thomas and grandmother of William Morley.⁸² In 1609 Sir Gilbert Kniveton, son-in-law of Andrew Grey, who afterwards held the manor in right of his wife, was living at Tannis.

In the 15th century there was a manor called *HACONS* in Aspenden, which seems to have taken its name from a family called Hacon, who were holding land in Aspenden in the 13th century. Walter Hacon appears as witness to a grant of land in Aspenden in 1240-1.⁸³ His daughter Agnes married William son of John de Hodenho. In 1304 Agnes's daughter and heir Nichola was claiming 1½ acres of land in Aspenden of her mother's inheritance against William de Poley and his wife Isabel.⁸⁴ In 1421 the 'manor called Hacons' was released by the feoffees of Robert Chelmsford to other feoffees to the use of Richard Kirkby.⁸⁵ After this date no further record of this manor has been found.

The church of *ST. MARY* consists of *CHURCH* chancel 22 ft. by 16 ft., south chapel 16 ft. 6 in. by 16 ft., nave 40 ft. by 19 ft., south aisle 37 ft. by 14 ft. 6 in., west tower 11 ft. 6 in. square and south porch 10 ft. by 9 ft., all internal dimensions. The walls are of flint rubble covered with cement; the south chapel is of brick, cemented; the roofs are tiled except over the south aisle, which is leaded.

The nave and chancel were probably erected early in the 12th century, though but little of that date remains; the chancel was altered and probably enlarged in the early 13th century; the south aisle belongs to the middle of the 14th century, and the west tower was built about 1390. In the 15th century the south chapel was added and the nave walls raised and a new roof put on, and probably the south aisle widened, and about 1500 the south porch was erected by Sir Robert Clifford. In 1622 the south chapel was altered and the arcade next the chancel inserted; the chancel arch was probably pulled down at this time to allow the arcade to be built. The church was restored in 1873, and has again been recently repaired.

The chancel has an east window of four lights with traceried head, originally of 15th-century work, but most of the stonework is modern. In the north wall is a single lancet of the early 13th century, widely splayed internally; the adjoining window is a



SAVILE, Earl of Mexborough. *Argent a bend sable with three owls argent thereon.*

⁶³ Thomas is not mentioned in any of the pedigrees of this family. William was the executor of his father's will. See P.C.C. 34 Chaynay.

⁶⁴ *Recov. R. Trin.* 1574, rot. 759.

⁶⁵ Feet of F. Herts. Hil. 17 Eliz.

⁶⁶ *Ibid.* East. 19 Eliz.

⁶⁷ *Ibid.* Hil. 20 Eliz.

⁶⁸ *Ibid.* Trin. 8 Jas. I.

⁶⁹ *Ibid.* East. 21 Jas. I.

⁷⁰ *Recov. R. Hil.* 1 Chas. I, rot. 101.

⁷¹ *Close*, 25 Geo. III, pt. xxii, no. 8,

m. 21.

⁷² G.E.C. *Complete Peerage*, s.v. Hardwicke, iv, 165.

⁷³ *Ibid.* s.v. Mexborough, v, 307.

⁷⁴ Burke, *Peerage* (1911).

⁷⁵ De Banco R. 651, m. 128.

⁷⁶ Feet of F. Herts. Hil. 20 Eliz.

⁷⁷ *Close*, 23 Eliz. pt. vii; *ibid.* pt. xxiii; *Chan. Inq. p.m.* (Ser. 2), cccxlvii, no. 75.

⁷⁸ W. Minet, 'Tannis Court,' *Home Co. Mag.* (1904), vi, 194.

⁷⁹ *Ibid.*

⁸⁰ *Recov. R. Trin.* 1574, rot. 759.

⁸¹ *Home Co. Mag.* loc. cit.

⁸² See Berry, *Sus. Gen.* 176; *Coll. Topog. et Gen.* iii, 2; *Visit. of Sussex* (Harl. Soc.), 47.

⁸³ *Anct. D.* (P.R.O.), A 108.

⁸⁴ De Banco R. 152, m. 49. The Poles held lands in Aspenden in the 14th century, which in 1363 were divided between the daughters and heirs of John Poley (*Anct. D.* [P.R.O.], A 999, 6720). For John and William Poley as jurors see *Inq. Non.* (Rec. Com.), 433.

⁸⁵ *Anct. D.* (P.R.O.), D 748.

small single light of early 12th-century work. The external arch is formed in flint rubble, but the original head may have been of stone. At the west end of the north wall is a low-side window with cusped ogee arch and roses in the spandrels; it is probably of early 16th-century date. Under the 13th-century lancet is a wide-arched recess, which may have been used as an Easter sepulchre. The moulded arch is pointed, the crocketed label forming an ogee arch above, with carved finial; the recess is flanked by pilaster buttresses with crocketed gables; the spandrels are traceried and the top embattled. It is of early 15th-century work, but has been restored. In the south wall of the chancel is a 13th-century lancet window, under which is an aumbry, chiefly modern, and part of the basin of a piscina with eight-foiled drain. The arcade between the chancel and the south chapel consists of two circular arches of two splayed orders. The piers are octagonal, and on each face and on the soffit of the arches are sunk panels carved with arabesques. The arms of Freeman, with the date 1622, appear over the arcade on the south side. There is no chancel arch; the chancel roof is modern.

The east window of the south chapel is of three cinquefoiled lights under a low elliptical head; the south window has two lights with similar detail; they are probably of 15th-century date altered in the 17th century. In the north-west angle is the blocked entrance to the rood stair. The chapel is inclosed with a 17th-century oak screen, the lower part of which is close panelled; the top is pierced with a series of round arches on moulded balusters. The pews, which are of the same date, are inclosed with plain panelled oak, and the doors retain their ornamental iron hinges. The roof is divided into panels by moulded timbers, and is of late 15th or early 16th-century date.

In the north wall of the nave are two windows, each having three lights with tracery under a four-centred arch. The tracery differs in the two windows, and has been much restored; they are both of 15th-century date. In the east jamb of the easternmost window is a niche for an image,⁸⁶ elliptical on plan, and with cusped ogee arch under a square head, the mouldings of which, and probably a canopy above, have been cut away; the spandrels are traceried. The north door, which is blocked, has continuously moulded arch and jambs much restored. The south arcade consists of three bays with pointed arches of three splayed orders, and octagonal piers with moulded capitals and bases; it dates from the middle of the 14th century. Over the arcade are modern dormer clearstorey windows. The roof is of early 15th-century date with plain timbers and curved struts.

The south aisle has a window in the south and another in the west wall, each of two cinquefoiled lights under a low segmental head; they are of late 15th-century date. Under the south window is a small recess with a cinquefoiled arch, probably a piscina. The south doorway is of late 15th-century date, and has a four-centred arch of two moulded orders, the inner order continuous, the outer forming a square head above; the spandrels are traceried. Over the doorway is a quartered shield of Clifford. On the outer face of the south wall is a small plain round-arched recess of brick covered with cement. The roof of the south aisle has moulded timbers of late 15th-century date; the south door is of oak of 17th-century date.

The south porch has an east and west window, each of two lights with traceried head. The entrance has a moulded two-centred arch under a square head, with moulded spandrels; the jambs are shafted. In the spandrels are two shields of arms, Clifford impaling Barley, and Jocelyn quartered with Blount and Malpas. The west tower is of three stages with embattled parapet and short leaved spire, which is

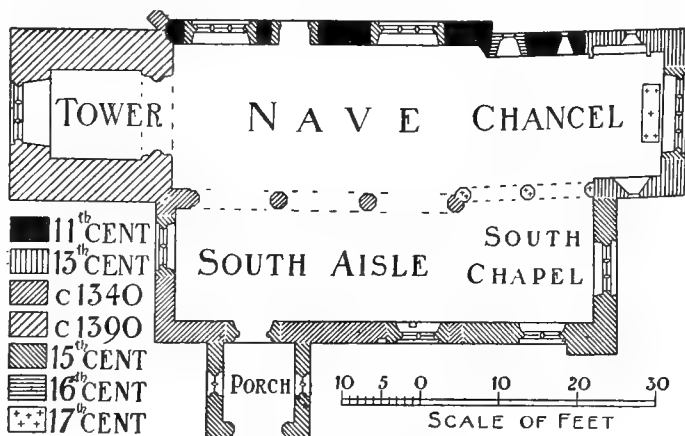

PLAN OF ASPENDEN CHURCH

dated 1721. The tower arch, which is of late 14th-century date, is of two moulded orders; the jambs have semi-octagonal shafts with moulded capitals and bases. In the west wall is a small modern doorway. The west window is almost entirely of modern stonework. The belfry windows are of single lights and have been restored.

The font has an octagonal basin, the north, south, east and west sides of which have traceried panels containing blank shields. It is probably of late 15th-century work, but has been restored.

On the south side of the chapel is an altar-tomb of Purbeck marble, the lower part decorated with square cusped panels placed diagonally, each containing a shield with indents of brasses. Over the tomb is a canopy supported on octagonal fluted shafts, and having frieze and carved cresting and traceried soffit.

⁸⁶ In 1501 John Myles left 16s. 8d. towards painting the image of our Lady and to the painting of the rood 6s. 8d. in Aspenden Church (P.C.C. 16 Moone). In 1505 John Archer left money for making a tabernacle of our Lady in the chancel and for painting of Mary and

John on both sides of the rood (P.C.C. 37 Holgrave). Thomas Goodriche in 1500 left 20s. for the repair of the church and a bequest to an honest priest to sing and pray for his soul and all Christian souls for the space of a year in Aspenden Church on Sundays and holy days and

in the chapel of St. Mary Magdalene in Buntingford on workdays (P.C.C. 9 Moone). In 1508 Walter Mace left a cow for painting the image of the crucifix (P.C.C. 35 Adeane).

A HISTORY OF HERTFORDSHIRE

At the back of the recess are brass kneeling figures of Sir Robert Clifford, 1508, and his wife Elizabeth, with an inscription underneath. On the knight's surcoat and on a shield behind him are his arms, Checky or and azure a fesse gules quartering Gules three rings or parted with Sable three crosses formy or, with the difference of a ring, and on the lady's mantle and on the shield behind her Clifford with its quarterings impaling Barley; the brasses retain traces of coloured inlay. Two other shields below the figures and one on the canopy have disappeared. On the moulded edge of the slab is a brass marginal inscription, 'Credo quod Redemptor meus vivit et in novissimo die de terra surrecturus sum et in carne mea videbo Deum Salvatorem meum. Tedet animam meam vitæ meae.' On the east wall of the chapel are tablets to Ralph Freeman, 1665, and to Mrs. Elizabeth Freeman, 1634. On the south wall

by Robert Phelps, 1736; the fourth, fifth, sixth and eighth by George Chandler, 1681; the seventh recast in 1871.

The communion plate consists of a cup, 1632, paten and almsdish, 1636, and modern silver paten and flagon.

The registers before 1812 are as follows: (i) all entries 1559 to 1709; (ii) baptisms and burials 1707 to 1812, marriages 1707 to 1753; (iii) marriages 1754 to 1812.

In 1237 presentation to the *ADVOWSON* church of Aspenden was made by the Prior and brethren of the Hospital of St. John of Jerusalem in England,⁸⁷ who were holding land in Aspenden in 1217-18.⁸⁸ The donor of the church is unknown. The Hospitallers held it until their dissolution,⁸⁹ but do not seem to have appropriated it. The advowson



ASPENDEN CHURCH FROM THE NORTH-EAST

of the aisle is a mural tablet to Sir Ralph Freeman, Lord Mayor of London, who died in 1634, and his brother William Freeman, 1623. On the tablet are two copper busts; that representing Sir Ralph wears the SS collar of the lord mayor. On the north wall of the nave are brass figures of a civilian and his wife, with imperfect inscription, dated 1500. On the south wall of the chapel on the outside is a tablet to John Ward, 1665, and his wife Martha, 1645; it was erected by Seth Ward, Bishop of Salisbury and founder of the hospital in Buntingford, in memory of his parents. Near the south doorway is an oak alms-box, probably of early 17th-century date.

There are eight bells: the first, second and third

was then held by the Crown⁹⁰ until 1604, when James I granted it to Sir Roger Aston and John Grimsdich,⁹¹ probably in trust for Sir John Brograve, kt., who presented to the church in 1607.⁹² It descended with the Brograves and Freemans (see Hamells in Braughing), and then with the Yorkes and Saviles (see Wakeley)⁹³ until recently acquired by Mr. Austin E. Harris.

There was originally a church attached to the manor of Berkesden, the site of which is still visible in the fields north of Berkesden Green. In 1086 a priest is mentioned as a tenant of the manor.⁹⁴ No record of any presentations remains, and the church is not mentioned in the *Taxatio* of 1290 or the

⁸⁷ See Clutterbuck, *Hist. and Antiq. of Herts.* iii, 351.

⁸⁸ Feet of F. Div. Co. 2 Hen. III, no. 3.

⁸⁹ Clutterbuck, loc. cit.; Land Rev. Misc. Bks. lvii, fol. 164.

⁹⁰ Clutterbuck, loc. cit.

⁹¹ Pat. 2 Jas. I, pt. xix, m. 8.

⁹² Clutterbuck, loc. cit.

⁹³ Chan. Inq. p.m. (Ser. 2), cccxxxv, 8; cccxcxi, 18; Recov. R. Mich. 1657, rot. 126; Inst. Bks. (P.R.O.); Close, 25 Geo. III, pt. xxii, no. 8.

⁹⁴ *V.C.H. Herts.* i, 321b.

Valor of 1535. It was probably served by the canons of Holy Trinity, to whom the manor (q.v.) belonged. It is said that on the division of the manor the church remained attached to that part of the manor which became annexed to Westmill, and that, on account of its ruinous condition, it was pulled down by John Brograve.⁹⁶ The site of the church, however, lies considerably north of Westmill.

The manor of Wakeley had a free chapel of its own, so that it was extra-parochial of Aspenden. The first reference to the church occurs towards the end of the 13th century.⁹⁶ In 1291 the church was valued at £4 13s. 4d.,⁹⁷ and at the same amount in 1428, but there were then said to be no inhabitants in the parish.⁹⁸ The advowson always remained in the hands of the lord of the manor.⁹⁹ Richard Morley presented to the church in 1454,¹⁰⁰ but after this no further presentation is recorded. In 1535 the free chapel of St. Giles in Wakeley was valued at £4.¹ It was described in 1547 as being not far from the parish church, and it was stated that the parson had for a long time taken its revenues.² The rectory afterwards descended with the manor (q.v.).

The following charities are regulated by a scheme of the Charity Commissioners of 30 November 1877, as varied by a scheme of 21 July 1908, namely:—

1. The charity of John Boldero, founded by will (date not stated), consisting of a dwelling-house and

six cottages situate at the Folly in this parish, let on lease for ninety-nine years from 24 June 1860, at £7 a year.

2. Charity of William Freeman for bread, will, 1623, originally a rent-charge of £10 8s., now £4 16 2½ per cent. annuities, with the official trustees, producing £10 8s. yearly.

3. Charity of Elizabeth Freeman, founded in 1630, consisting of £5 a year received from the Haberdashers' Company, London.

4. Joan Sanbach, will, 1605, originally a rent-charge of £2, now £80 2½ per cent. annuities, with the official trustees, producing £2 a year.

5. The Poor's Land, consisting of 3 r. 15 p., part of a field known as 'Twelve Acres,' let at £1 a year, and an amount of tithe.

The distribution of the income derived from these sources is made in bread and in gifts to the coal and clothing clubs.

For the Free School see article on Schools.³ The school and its subsidiary endowments are now regulated by a scheme of the Board of Education, 5 April 1910.

The official trustees hold a sum of £1,460 2½ per cent. annuities, as 'The Educational Foundation,' producing £36 10s. yearly, comprising the charities of Mary Cator (£320 stock), William Freeman and Ralph Freeman school charity (£370 stock), Ralph Freeman for clothing (£290 stock), and Bishop Seth Ward's charity for apprenticing (£480 stock).

BARKWAY

Bercheweig, Berchewei (xi cent.); Bercweie (xii–xiii cent.); Berkwey (xiii cent.).

The parish of Barkway lies on the Hertfordshire chalk hills in the extreme north-east of the county. Its northern boundary is the Icknield Way, which divides Hertfordshire from Cambridgeshire. East of it are the parishes of Barley, co. Herts., and Langley, co. Essex.

The soil in some parts is clay. Out of a total of 5,211 acres, about three-fifths are arable land, rather more than one-fifth is pasture, and there are 555 acres of woodland.¹ The names of the woods recall the history of the parish. Scales Park is named from the Lords Scales, who held a small fee in Barkway in addition to the manor of Newsells²; Earl's Wood takes its name from the Earls of Hereford, lords of Nuthampstead; and Rokey Wood, on the road to Reed, preserves the name of a manor now held with the main estate of Newsells.

The village lies on high ground near the River Quin and forms a single street on the main road from Ware to Cambridge. The church lies to the west of the street, and the house formerly known as Church Farm and now as the Manor House, the residence of Mr. J. W. Sworder, stands close to it on the south. The Manor House was originally an L-shaped building, the main portion running east and west, with a wing projecting southwards, but a wing added in the 19th century has made the house almost square on plan. It is of two stories with attics. It appears to

have been built early in the 17th century of timber framing covered with plaster, part of which remains on the north and west sides, but about the middle of the century most of the external walls were rebuilt in brick. The east end of the main building has a mid-17th-century curvilinear gable, and in each story is a five-light window of brick with cement-covered mullions and square head with moulded label. The lights to the lowest window have four-centred arches; the large window to the attic story is divided by a transom. The south end of the wing has a hipped roof; the end windows have brick mullions, but they are not placed centrally in the wing. All the roofs are tiled. The modern addition has a gable on the south front to correspond with the old east gable. There are two old chimney stacks, each consisting of a row of detached octagonal brick shafts united at their moulded bases and at their capitals, which are plain oversailing courses star-shaped on plan. The interior of the house has been much modernized, but in some of the rooms is early 17th-century panelling. In an upper room of the south wing is a clunch fireplace with a flat four-centred moulded arch having a square head over decorated with billets; in the entrance hall is another stone fireplace with four-centred moulded arch and carved spandrels. Adjoining the house is an early 17th-century barn of nine bays with boarded sides.

There are several old tiled and thatched cottages in the High Street of the village, probably dating from

⁹⁶ Chauncy, *Hist. Antiq. of Herts.* 119.

⁹⁷ Anct. D. (P.R.O.), A 7214.

⁹⁸ *Pope Nich. Tax. (Rec. Com.)*, 42b.

⁹⁹ *Feud. Aids*, ii, 457.

⁹⁹ Clutterbuck, *op. cit.* iii, 349.

¹⁰⁰ *Ibid.*

¹ *Valor Eccl. (Rec. Com.)*, iv, 278.

² *Chant. Cert.* 20, no. 81.

³ *V.C.H. Herts.* ii, 100.

¹ Statistics from Bd. of Agric. (1905).

² See below.

A HISTORY OF HERTFORDSHIRE

the late 16th or early 17th century, but they have been considerably modernized. On the east side, opposite the entrance to the manor-house, is a larger building, of timber framing covered with plaster, and with tiled roof; it is probably of early 17th-century date. In the front are three large overhanging gables on carved brackets, under which are wide bay windows of two stories; the front porch is modern. There is a wide late 17th-century staircase at the back of the house, with heavy moulded and twisted balusters. The central chimney has three plain octagonal shafts. The interior has been much altered. At the north end of the High Street is a Congregational chapel built in 1886. Of an older chapel built about 1786³ nothing remains except the graveyard.

The position of the village on the main road gave it some importance.⁴ In the 16th and 17th centuries it was accounted an intermediate stage between Ware and Witchford Bridge or Cambridge and

A second fair was held at Nuthampstead on Thursday before 24 June (St. John Baptist) and the three following days.¹¹ The market is extinct,¹² and the fairs were abolished in 1883.¹³ The Gild Hall or Town House, devoted to the maintenance of an anniversary in the church, was purchased by Sir Robert Chester after the dissolution of chantries.¹⁴

Newsells Park, the seat of Mr. F. W. Woodhouse, J.P., is situated about a mile north of the village. The house was probably built towards the end of the 17th century by William or Thomas Newland, but has later additions. The older part consists of a rectangular building with wings projecting southwards; about the middle of the 18th century an addition was made on the east side, and in recent times the space between the wings was inclosed to form a hall one story in height. The house is of three stories; the walls are of brick with moulded stone cornice with brackets at the eaves; the roofs are



SOUTH END OF MAIN STREET, BARKWAY

Hunsdon.⁵ There is record of several 15th and 16th-century inns, the 'Swan,' the 'George' and the 'Antelope.'⁶

The market-house was demolished and rebuilt as a school-house or market-house about 1638.⁷ A market-place existed early in the 13th century,⁸ and a Tuesday market was granted to the lord of Newsells in 1270.⁹ At the same time was granted a yearly fair to be held for eight days beginning on the vigil of the feast of St. Mary Magdalene (i. e. 21 July).¹⁰

slated and are hipped at the ends of the wings. On the east side of the house is an addition of about the middle of the 18th century in the Adam style, the front wall forming a flat ellipse on plan. In the billiard room in the west wing is some late 17th-century panelling. In the dining room at the back, which is a lofty room carried up two stories with an enriched coved plaster ceiling, are some carved wood festoons of fruit and flowers in the style of Grinling Gibbons. Most of the principal rooms have carved

⁵ *Sess. R.* (Herts. Co. Rec.), ii, 156.

⁴ In the 14th century the road was evidently unsafe. John de Lancaster, lord of Rokey Manor, was among the men charged with robbing the Earl of Pembroke at Barkway by night in 1347 (*Cal. Pat.* 1345-8, p. 307), and the servants of Queen Isabella were attacked at Barkway shortly afterwards (*ibid.* 1348-50, p. 243).

⁵ *L. and P. Hen. VIII*, xvi, 677 (ix); *Cal. S. P. Dom.* 1644-5, p. 170.

⁶ *Chan. Inq. p.m.* 28 Hen. VI, no. 21; Feet of F. Herts. Trin. 2 Edw. VI; East. 6 Edw. VI; East. 1 Eliz.; *Star Chamb. Proc. Phil. and Mary*, bdle. 6, no. 3; *Early Chan. Proc.* bdle. 278, no. 42.

⁷ *V.C.H. Herts.* ii, 102.

⁸ *Cart. Mon. S. Johannis de Colecestria*

(Roxburghe Club), 630, in a charter dating between 1195 and 1238.

⁹ *Cal. Chart. R.* 1257-1300, p. 146.

¹⁰ *Ibid.*

¹¹ *Lond. Gaz.* 27 Apr. 1883, p. 2242.

¹² It probably lost its importance with the growth of the town of Royston.

¹³ *Lond. Gaz.* loc. cit.

¹⁴ *Pat. 7 Edw. VI*, pt. iii, m. 25.

chimney-pieces of marble or wood, and all the woodwork of shutters and panelling has carved and enriched mouldings. In the library on the east side the chimney-piece and ceiling are enriched after the Adam style. A rain-water head at the back bears the date 1739. Newsells Bury adjoins Newsells Park; it is a very plain brick building, probably of late 17th-century date.

Nuthampstead is a separate civil parish, but is included in the ecclesiastical parish of Barkway. At Nuthampstead in the house of Roger Nuers, son of Ralph Nuers, lord of the manor, a private chapel was founded in 1141-51.¹⁵ The chaplain presented by Roger was to take an oath to the incumbent of Barkway not to encroach upon the rights of the mother church of Barkway.¹⁶ Before 1154 Ralph Nuers gave to Colchester Abbey all right in Nuthampstead chapel.¹⁷ It was still existing in 1539 when the farmer of the Rectory Manor paid a yearly stipend to the chaplain celebrating 'in the church of Nuthampstead.'¹⁸ It was excepted from the grant of the Rectory Manor to William Gery¹⁹ and seems to have fallen into decay. At Nuthampstead in 1617 was a capital message called 'Cayles.'²⁰ At Parsonage Farm is a homestead moat now almost levelled.

Arable fields slope away northwards and westwards towards the Icknield Way and the town of Royston, part of which lay in Barkway parish until 1540.²¹ The common lands were inclosed about 1808.²² East of the village in and beyond the valley of the Quin lie the woods and pastures of Great Cokenach and Nuthampstead. Beyond these on the Essex border are Scales Park and Little Cokenach. There was a chantry chapel of St. Gunwal at Little Cokenach in the 12th century.²³ Near Little Cokenach are brickworks, and chalk has been dug at Nuthampstead and in the west of the parish near the border of Reed.

At Periwinkle Hill, opposite Rokey Wood, is a moated mound with two small baileys, rapidly becoming level through constant ploughing.²⁴ Near Rokey was a windmill, now turned into a cottage. This was probably Rokey Mill, which was standing, though much dilapidated, in 1595.²⁵ Another mill (now also turned into a cottage) stood on the other side of the road. No mill is mentioned in the Survey of 1086, but a mill at Cokenach was in the custody of the lord of Newsells about 1271.²⁶

The 'hermitage' in Barkway, held by Sir Robert Chester at his death,²⁷ may be Royston Hermitage, which lay within this parish.²⁸ Rushingwell Farm, in the valley of the Quin, is evidently on the site of the house called 'Rusheenwell' owned by Sir Henry Prannell, lord of Newsells.²⁹ The tenement called 'Knyghtshankines' about 1330 presumably took its name from Peter Knightshank, a former occupier.³⁰

NEWSSELLS MANOR (Neusela or *MANORS* Nieweseles, xi-xii cent.³¹; Newesel or Neweseles, xiii cent.) lies to the north of the village on the main road. It was held before the Conquest by a thegn of King Edward's named Aldred and by two sokemen, one of whom was Aldred's man and the other Earl Algar's man. In 1086 Eudo Dapifer held it in demesne.³² Newsells evidently reverted to the Crown after his death in 1120 and was granted by Henry I to Eustace Count of Boulogne.³³ The overlordship remained in the honour of Boulogne,³⁴ the service due being that of three halves of a knight's fee.³⁵

Members of the Merk family were the immediate tenants of the manor in the 12th century.³⁶ A Eustace de Merk was witness to the charter of Count Eustace confirming Barkway Church to Colchester Abbey,³⁷ and as others of the same family were elsewhere tenants of the Counts of Boulogne³⁸ it appears possible that he was already tenant of Newsells under the count. A Sir Eustace de Merk, kt., who was living in the reign of Richard I,³⁹ was styled 'lord of Newsells' and founded a chapel at Royston within this lordship.⁴⁰ He is probably identical with the 'Eustace de Oye, son of Henry de Merk,' living in April 1190.⁴¹ Sir Eustace de Merk, kt., was also styled 'de Rochester'⁴² and was succeeded as tenant (apparently within his own lifetime) by his nephew Ralph de Rochester.⁴³ This Ralph had been preceded by a 'Baldwin de Rochester,'⁴⁴ presumably the Baldwin de Rochester who witnessed a charter of Henry father of Eustace 'de Oye'⁴⁵ and perhaps a son of the same Henry. In this case Ralph would be son of Baldwin de Rochester. Newsells was the 'caput' of the barony which Ralph de Rochester held of the honour of Boulogne.⁴⁶ Ralph's son and heir William de Rochester died shortly before 24 October 1249 and was succeeded by his brother Peter de Rochester,⁴⁷ parson of Rivenhall, co. Essex.⁴⁸ Shortly before his death Peter took the habit of a Knight Templar.⁴⁹ On the Saturday before Ascension Day, 1255, as he

¹⁵ *Cart. Mon. S. Johannis de Colecestria* (Roxburghe Club), 382.

¹⁶ *Ibid.*

¹⁷ *Ibid.* 175.

¹⁸ *Mins. Accts. Hen. VIII, R.* 976.

¹⁹ *L. and P. Hen. VIII, xix* (1), 610 (52).

²⁰ *Chan. Proc.* (Ser. 2), bde. 325, no. 29.

²¹ *V.C.H. Herts.* iii, 253.

²² *Under Priv. Act.*, 41 *Geo. III*, cap. 98 (not printed). The award is enrolled on *Com. Pleas Recov. R. Trin.* 10 *Geo. IV*, m. 23.

²³ See below under Little Cokenach. For the name cf. 'Wynnels Grove' in *Barley*.

²⁴ *V.C.H. Herts.* ii, 118.

²⁵ *Proc. of Ct. of Req. bde.* 33, no. 71.

²⁶ *Curia Regis R.* 204, m. 2.

²⁷ *Chan. Inq. p.m.* (Ser. 2), clxx, 51.

²⁸ *V.C.H. Herts.* iii, 254.

²⁹ *Chan. Inq. p.m.* (Ser. 2), cccxliii, 168.

³⁰ *De Banco R.* 281, m. 32 d.

³¹ For the spelling 'Senseles' (*Harl. MS.* 7041, fol. 7) see *V.C.H. Herts.* iii, 260, n. 75.

³² *V.C.H. Herts.* i, 329a, 329b.

³³ *Cart. Mon. S. Johannis de Colecestria* (Roxburghe Club), 47; cf. *Round, Peerage and Family Hist.* 163.

³⁴ *Testa de Nevill* (Rec. Com.), 273b, 274b; *Chan. Inq. p.m.* 46 *Edw. III* (1st nos.), no. 63.

³⁵ *Red Bk. of Exch.* (Rolls Ser.), 502.

³⁶ See below.

³⁷ *Cart. Mon. S. Johannis de Colecestria*, loc. cit.

³⁸ *Round, Peerage and Family Hist.* 156-7.

³⁹ *Rot. Cur. Regis* (Rec. Com.), ii, 219.

⁴⁰ *Harl. MS.* 7041, fol. 7; cf. *V.C.H. Herts.* iii, 260.

⁴¹ *Cart. Mon. S. Johannis de Colecestria* (Roxburghe Club), 37, 513.

⁴² See Newberry in *Weston, Broadwater Hundred*.

⁴³ *Harl. MS.* 7041, fol. 7; cf. *Red Bk. of Exch.* 502, 576; *Testa de Nevill* (Rec. Com.), 273b, 274b.

⁴⁴ Baldwin 'de Rouec' [Rochester] gave lands in Newsells to Coggleshall Abbey in or before the time of Henry II (*Cal. Pat.* 1388-92, p. 79).

⁴⁵ *Cart. Mon. S. Johannis de Colecestria* (Roxburghe Club), 36.

⁴⁶ *Hund. R.* (Rec. Com.), i, 193. The barony evidently consisted of five and a half fees in Barkway and Newsells, co. Herts., Rivenhall and Lawford, co. Essex, and Eriswell and 'Coclesworth' (in Eriswell), co. Suffolk.

⁴⁷ *Cal. Inq. p.m. Hen. III*, 38; *Harl. MS.* 7041, fol. 7b.

⁴⁸ *Chan. Inq. p.m. file* 19, no. 2. ⁴⁹ *Ibid.*

A HISTORY OF HERTFORDSHIRE

lay on his death-bed he granted Newsells Manor to his sister Alice widow of Robert de Scales,⁶⁰ making her swear to provide a chaplain to celebrate for his soul, or in case of his recovery to compensate him from her own lands in Cambridgeshire.⁶¹ He died on the Ascension Day following.⁶² At the outbreak of the Barons' War Alice Scales was residing at Newsells and was there robbed of goods and chattels worth £50 by the bailiff of Gilbert Earl of Gloucester.⁶³ In 1264 she subtenanted her youngest son Roger Scales of Wetherden of the manor⁶⁴; but in 1270 it was agreed between Roger and Alice that the former's tenure should be for life only.⁶⁵ In the same year Robert son of Roger's elder brother Robert, heir to the manor under the new settlement,⁶⁶ obtained a grant of a weekly market on Tuesdays and an eight days' fair beginning on the vigil of the feast of St. Mary Magdalene.⁶⁷ This Robert was the first Lord Scales and married Isabel Burnell,⁶⁸ possibly a relative of Robert Burnell, Bishop of Bath and Wells, the chancellor and adviser of Edward I. Roger Scales transferred to the bishop his life interest in Newsells Manor⁶⁹ before the end of the year 1271.⁶⁰

In 1275 the jurors of Edwinstree Hundred returned that the whole barony formerly held by Ralph de Rochester had been alienated since his time, that the 'caput' (Newsells) was in the hands of Burnell, and that the heirs of the barony had nothing whereof they could answer to the king.⁶¹ In January 1279-80 Robert de Weston and his wife Hawise, who was niece of Peter de Rochester,⁶² released to the bishop all their right and that of Sir Robert Scales in Newsells Manor.⁶³ In 1292 Burnell conveyed his interest to Robert Lord Scales and Isabel his wife.⁶⁴ Isabel survived her husband and held the manor for life.⁶⁵ About 1315 Robert son and heir of Robert and Isabel reserved Newsells in making settlement of other estates on his wife Egelina.⁶⁶ His son Robert third Lord Scales granted a life interest in the manor to Sir Robert Thorp, kt.⁶⁷ Upon the death of the latter, Newsells reverted to Roger Lord Scales, son of the third baron.⁶⁸ He was succeeded

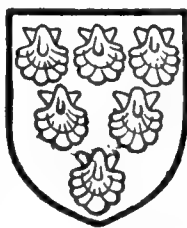

SCALES. Gules six scallops or.

by his son Robert fifth Lord Scales,⁶⁹ who styled himself 'lord of Newsells' in his will dated 10 May 1400.⁷⁰ His widow Elizabeth, afterwards wife of Sir Henry Percy of Athol, kt.,⁷¹ had a life interest in Newsells.⁷² After her death, 6 January 1439-40, it reverted to Thomas Lord Scales, younger son and ultimate heir of her first husband.⁷³ In the following September he had protection for his tenants at Newsells during his absence in France,⁷⁴ where he distinguished himself as seneschal of Normandy.⁷⁵ His only daughter and heir Elizabeth married Sir Anthony Wydville (afterwards Earl Rivers), brother-in-law of Edward IV.⁷⁶

In 1466 Newsells was entailed on Elizabeth Scales and her husband,⁷⁷ who became Lord Scales in her right.⁷⁸ She died childless 1 September 1473,⁷⁹ and Earl Rivers endeavoured to retain in his own family Newsells and her other lands by bequeathing them to his brother Sir Edward Wydville.⁸⁰ The earl was beheaded by the partisans of the Duke of Gloucester, who as Richard III granted Newsells to his kinsman John Duke of Norfolk, at first during pleasure,⁸¹ later in tail-male.⁸² The duke was a descendant of Sir Robert Howard, kt., grandson of Margaret Scales, one of the daughters of Robert third Lord Scales; but John Vere, thirteenth Earl of Oxford, who was descended from an elder grandson of the same Margaret, was co-heir to the Scales inheritance with William Tyndall, the representative of Margaret's sister Elizabeth.⁸³ Oxford had been attainted before the death of Earl Rivers, but was restored in October 1485.⁸⁴ With Tyndall he received the proceeds of Newsells⁸⁵ after the battle of Bosworth, in which he commanded the supporters of the Earl of Richmond (Henry VII),⁸⁶ and Henry assigned this and other manors to him in a partition of the Scales estate.⁸⁷ His widow Elizabeth held Newsells in dower.⁸⁸ His nephew and heir male, John fourteenth Earl of Oxford, died without issue in 1526,⁸⁹ and the reversionary right to Newsells contingent upon the death of the Dowager Countess Elizabeth was assigned to the heir male,

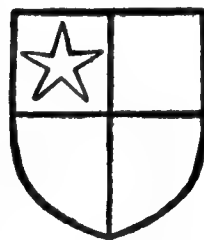

VERE. Quarterly gules and or with a molet argent in the quarter.

⁶⁰ Chan. Inq. p.m. file 19, no. 2; cf. *Excerpta e Rot. Fin.* (Rec. Com.), ii, 70, 326; Feet of F. Herts. 54 Hen. III, no. 617.

⁶¹ Chan. Inq. p.m. file 19, no. 2; *Cal. Pat.* 1247-58, p. 437. At the same time he granted Rivenhall Manor to her son Robert (*Excerpta e Rot. Fin.* [Rec. Com.], ii, 326).

⁶² Chan. Inq. p.m. file 19, no. 2.

⁶³ *Abbrev. Plac.* (Rec. Com.), 168.

⁶⁴ Feet of F. Herts. 48 Hen. III, no. 575; cf. Chester Waters, *Chesters of Chicheley*, 254.

⁶⁵ Feet of F. Herts. 54 Hen. III, no. 617.

⁶⁶ *Ibid.*; cf. *Excerpta e Rot. Fin.* (Rec. Com.), ii, 70, 326; Chester Waters, loc. cit.

⁶⁷ *Cal. Chart. R.* 1257-1300, p. 146.

⁶⁸ Evidence in Scales peerage case quoted by Chester Waters, *Chesters of Chicheley*, 254. She is said to have been

niece of the chancellor (Page, *Suff. Traveller*, 555).

⁶⁹ *Hund. R.* (Rec. Com.), i, 193; Assize R. 323, m. 1 d., 45.

⁷⁰ In 1271 Burnell impleaded Ivo le Messer and others for breaking into Cokenach Mill, of which he had the custody (Curia Regis R. 204, m. 2, 22).

⁷¹ *Hund. R.* (Rec. Com.), i, 193.

⁷² Assize R. 323, m. 1 d.

⁷³ Coram Rege R. 51, m. 4 d.

⁷⁴ Feet of F. Herts. 20 Edw. I, no. 281; cf. *Feud. Aids*, ii, 431.

⁷⁵ *Cal. Close*, 1302-7, p. 294.

⁷⁶ Inq. a.q.d. file 116, no. 15; *Feud. Aids*, i, 439.

⁷⁷ Chan. Inq. p.m. 46 Edw. III (1st nos.), no. 63.

⁷⁸ *Ibid.*

⁷⁹ Close, 19 Ric. II, m. 3 d.; *Feud. Aids*, ii, 444.

⁸⁰ Nichols, *Test. Vetusta*, 151.

⁸¹ G.E.C. *Complete Peerage*, vii, 72.

⁷² Chan. Inq. p.m. 18 Hen. VI, no. 38.

⁷³ *Ibid.*; cf. G.E.C. loc. cit.

⁷⁴ *Cal. Pat.* 1436-41, p. 467.

⁷⁵ G.E.C. loc. cit.

⁷⁶ *Ibid.*

⁷⁷ Feet of F. Div. Co. 6 Edw. IV, no. 37; Chan. Inq. p.m. (Ser. 2), i, 37.

⁷⁸ G.E.C. loc. cit.

⁷⁹ Chan. Inq. p.m. 13 Edw. IV, no. 45.

⁸⁰ *Test. Vetusta*, 380.

⁸¹ *Cal. Pat.* 1476-85, p. 365.

⁸² *Ibid.* 497.

⁸³ Chester Waters, *Chesters of Chicheley*, 254-5. ⁸⁴ *Parl. R.* vi, 281.

⁸⁵ Waters, *Chesters of Chicheley*, 256.

⁸⁶ G.E.C. *Complete Peerage*, vi, 168.

⁸⁷ Waters, loc. cit.; Chan. Inq. p.m. (Ser. 2), xxviii, 68. His signature exists at the foot of a lease of the tenement called 'Whelers' in Barkway, 22 July 1509 (Add. Chart. 16572).

⁸⁸ Ct. of Wards D. box 144, no. 1.

⁸⁹ G.E.C. loc. cit.



BARKWAY VILLAGE FROM THE SOUTH



BARKWAY : OLD HOUSE IN HIGH STREET

John fifteenth Earl of Oxford, in March 1531–2.⁹⁰ Elizabeth died 6 November 1537.⁹¹ John son and heir of the last-named earl had livery of Newsells and the other estates of his father in 1540.⁹² His son Edward, the seventeenth earl, through whose extravagance was dispersed a considerable portion of the Oxford estate,⁹³ sold Newsells Manor to Henry Prannell, alderman and vintner of London, in 1579.⁹⁴

Prannell bequeathed two-thirds of the manor to his wife Anne with remainder to his son Henry.⁹⁵ In 1597 the latter made a settlement in favour of the heirs of his wife Frances daughter of Thomas (Howard) Viscount Bindon, 'at the importunity of her great friends,' thus disinheriting his sisters Joan wife of Robert Brooke and Mary wife of John Clarke.⁹⁶ With Brooke he had recently been in dispute as to the lease of a windmill and meadow called 'Rookey Meade' in Barkway.⁹⁷ His widow married Edward Earl of Hertford⁹⁸ and later Ludovic (Stuart) Duke of Richmond and Lennox. Mary Clarke and the daughters of Joan Brooke attempted to recover their reversionary interest in the manor, proving in the Court of Wards a later settlement by which Henry Prannell had limited the title of his wife to a life interest.⁹⁹ After the death of the Duchess of Richmond in 1639¹⁰⁰ Lord Maltravers, who had married Elizabeth sister of Ludovic Duke of Richmond and was son of Thomas (Howard) Earl of Arundel and Surrey, entered upon Newsells 'by some gift of the Duchess.'¹ His son Thomas Earl of Arundel, afterwards Duke of Norfolk, was in possession on 13 September 1652.² Apparently in 1653 the manor was in the possession of Robert Slingsby,³ son of Sir Guildford Slingsby, kt. In March 1660–1 he was created a baronet and became comptroller of the navy.⁴ He is said to have married a daughter of Robert Brooke⁵ and to have purchased the rights vested in the heir of Mary Clarke.⁶ He was a Royalist, and in compounding for his estates in 1652 had stated that the Earl of Arundel detained from him two manors in Barkway.⁷ His second wife Elizabeth Radclyffe survived him,⁸ and is said to have sold the manorial rights of Newsells to Edward Chester,

eldest son of Sir Edward Chester, the lord of Nuthampstead.⁹

Newsells Park and demesne lands were purchased late in the 17th century by William Newland, who transferred them to his son Thomas.¹⁰ They were subsequently purchased by Rear-Admiral Sir John Jennings,¹¹ who served under Rooke at Gibraltar and was for many years Admiral of the White.¹² His son George Jennings reunited Newsells Park with the manorial rights by acquiring the latter from Edward Chester, grandson of the former purchaser.¹³ George Jennings was succeeded by his daughter Hester Elizabeth wife of John (Peachey), second Lord Selsey.¹⁴ She died 19 April 1837, and

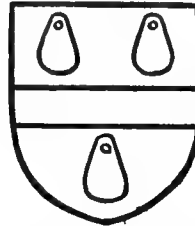

JENNINGS. *Argent a fesse gules between three plumets sable.*

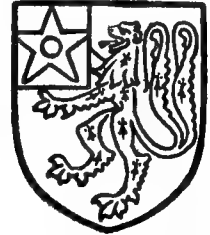

PEACHEY. *Azure a lion ermine with a forked tail and a quarter argent with a pierced molet gules therein.*

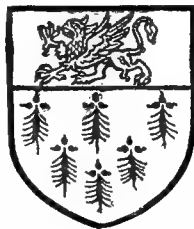

CHESTER. *Ermine a chief sable with a griffon passant argent therein.*

her only surviving son, Henry John third Lord Selsey, died childless in the year following. The estate was inherited by his sister the Hon. Caroline Mary wife of the Rev. Leveson Vernon-Harcourt. She also died without issue in 1871 and the property passed under the terms of Lady Selsey's will to Hugh Rose Lord Strathnairn, the eldest surviving son of Dame Frances Rose, legatee of the contingent remainder. In 1859 his sister Frances Dowager Countess of Morton, to whom the reversion after the death of Lord Strathnairn and his brothers (they having no issue) belonged, broke the entail and afterwards by her will left the Newsells estate in trust for sale, an option to purchase being reserved to her second son George Henry Douglas. This he exercised in 1886, the year after the death of Field-Marshal Lord Strathnairn.¹⁵ In 1897 the manors were bought from him by Mr. Alexander Crossman of Orgreave Hall, Lichfield, who afterwards sold the estate of Newsells, Nuthampstead, Berwick, Hedleys and

⁹⁰ Ct. of Wards D. box 144, no. 1, 2.

⁹¹ G.E.C. loc. cit.

⁹² Ct. of Wards Misc. Bks. dlxxviii, fol. 378; cf. Feet of F. Div. Co. East. 2 Edw. VI.

⁹³ Camden, *Elizabeth* (ed. 1717), 94.

⁹⁴ Feet of F. Herts. East. 21 Eliz.; Pat. 21 Eliz. pt. v. A settlement had been made upon the earl's marriage with Anne daughter of Lord Burghley (Recov. R. Hil. 14 Eliz. rot. 704).

⁹⁵ Pat. 32 Eliz. pt. xxi, m. 27.

⁹⁶ Chan. Inq. p.m. (Ser. 2), cccxliii, 168; cf. Recov. R. East. 24 Eliz. rot. 46; Chan. Proc. (Ser. 2), bdle. 398, no. 148.

⁹⁷ Ct. of Req. bdle. 33, no. 71.

⁹⁸ Chan. Inq. p.m. (Ser. 2), cccxliii, 168.

⁹⁹ Chan. Proc. (Ser. 2), bdle. 398, no. 148; cf. Feet of F. Herts. Trin. 17 Jas. I.

¹⁰⁰ *Dict. Nat. Biog.*

¹ Chan. Proc. (Ser. 2), bdle. 398, no. 148.

² *Cal. Com. for Comp.* 1890.

³ Ct. Bk. in possession of Messrs. Crossman and Prichard.

⁴ Pat. 13 Chas. II, pt. iii, no. 7.

⁵ Foster, *Yorks. Pedigrees*. She is styled 'Elizabeth.' Two of the daughters of Robert and Joan Brooke were Frances and Katherine (Chan. Proc. [Ser. 2], bdle. 398, no. 148).

⁶ Chauncy, *Hist. Antiq. of Herts.* 102. In 1682 the Duke of Norfolk made settlement of the manor (Com. Pleas D. Enr. Trin. 34 Chas. II, m. 2), but there is no further evidence of any claim put forward by the heirs of Lord Maltravers.

⁷ *Cal. Com. for Comp.* 1890.

⁸ G.E.C. *Baronetage*, iii, 177.

⁹ Chauncy, loc. cit.

¹⁰ *Ibid.*

¹¹ Clutterbuck, *Hist. and Antiq. of Herts.* iii, 365; cf. Exch. Dep. Mich. 25 Geo. II, no. 3.

¹² *Dict. Nat. Biog.*

¹³ Clutterbuck, op. cit. iii, 363; cf. Recov. R. Trin. 7 Geo. II, rot. 239; 13 Geo. II, rot. 115.

¹⁴ G.E.C. *Complete Peerage*, vii, 109; cf. Feet of F. Herts. Hil. 29 Geo. III. In 1786 a quitclaim of a moiety of the manor was made by Richard Vachell and his wife Margaret to William Chamberlayne with warranty against Margaret's heirs (*ibid.* Trin. 26 Geo. III). It has not been ascertained what their interest in the manor was.

¹⁵ Abstract of title communicated by Messrs. Crossman and Prichard.

A HISTORY OF HERTFORDSHIRE

Water Andrews and the Rectory Manor to Mr. F. W. Woodhouse, but who still holds the manorial rights.¹⁶

In 1287 Robert Burnell claimed gallowes, amendment of assize of bread and ale and view of frankpledge at Newsells.¹⁷ Free warren in Barkway was granted to Robert first Lord Scales in 1270,¹⁸ and in 1299 he complained that Walter de Barley and certain others, chiefly from the neighbourhood of Barley, had broken his warren at Newsells and hunted and carried away his deer.¹⁹ It is not clear whether the warren made by the first Lord Scales was Newsells Park or the wood called Scales Park which lies at some distance from Newsells on the borders of Langley, co. Essex.²⁰ Scales Park or Wood was alienated from the manor of Newsells by John sixteenth Earl of Oxford. He sold it early in 1548 to Robert Chester,²¹ who had already acquired Nuthampstead and Cockenach. The earl reserved to himself an annual rent of £10.²²

A small holding in Barkway was in 1086 in the hands of two men who held of Harduin 'de Scalers.' Two sokemen, the one of Earl Algar, the other of Eldred, had held this land before the Conquest.²³ Possibly these were the same sokemen who had held a part of Newsells.²⁴

NUTHAMPSTEAD BURY or **EARLSBURY** (Nothamstede, xii-xiv cent.; Northamstede, xiii-xiv cent.; Northampstede, xiv-xv cent.; Nothampsted, xv cent.; Northamsted *alias* Erlesbury,²⁵ xvi-xvii cent.; Nuthampstead Bury *alias* Earlsbury *alias* Nusted or Nutsted, xviii cent.) lies to the east of Barkway village. It is identical with the 3 hides in Barkway held of Geoffrey de Mandeville as a 'manor' by a certain Hugh in 1086. It had previously been held by two men of Asgar the Staller.²⁶ The tenant in the fifth decade of the 12th century was a certain Ralph Nuers ('de Noeriis'), whose son Roger built a chapel 'in his court' at Nuthampstead between 1141 and 1151.²⁷ At this time Ralph was still living,²⁸ and he apparently survived his son, as in a grant of pasture-land to the abbey of St. John, Colchester, he makes mention of his daughters as his heirs.²⁹ Ralph had also given to the abbey a carucate of land in the east of the parish abutting on Clavering Park.³⁰ Ernulph son of Geoffrey first Earl of Essex deprived the abbey of this land, which was restored by order of his brother the second earl.³¹ Nuthampstead had probably reverted to the overlords before this time. It was certainly held by Humphrey de Bohun Earl of Hereford and Essex, son of Maud sister and heir of William de Mandeville Earl of

Essex. He gave it with other lands to his younger son Henry.³² Humphrey Earl of Hereford and

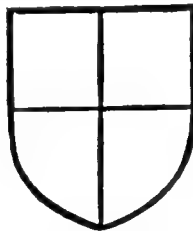

MANDEVILLE. Quarterly or and gules.

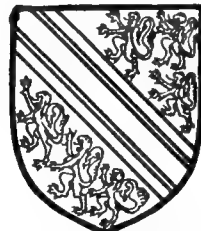

BOHUN. Azure a bend argent cotised or between six lions or.

Essex, grandson of the last-named earl, warranted the manor for life to his uncle Henry in 1278.³³ In 1315 his grand-nephew Humphrey Earl of Hereford and Essex gave the manor to Henry the Chamberlain as a pledge for the surrender of his manor of Denny, co. Cambs.³⁴ Nuthampstead was evidently recovered by Earl Humphrey, who was killed at Boroughbridge in 1322,³⁵ or by his son John, who succeeded his father. He let the manor in 1335 for nine years to the Abbot and convent of Walden, co. Essex,³⁶ who were lords of Cockenach Manor (q.v.).

Upon Earl John's death in January 1335-6 his right in Nuthampstead Manor descended to his brother Humphrey.³⁷ He obtained from the Prioress of Campsey release of a rent of 100s. yearly,³⁸ which had been charged on the manor since the time of Earl Humphrey, his great-great-grandfather.³⁹ He died 15 October 1361, and was succeeded by his nephew Humphrey,⁴⁰ who died 16 January 1372-3, leaving as heirs two daughters, Eleanor, aged fourteen, who was already married to the king's uncle, Thomas of Woodstock, and Mary,⁴¹ who afterwards married Henry Earl of Derby, son of John of Gaunt, but died in 1394 before his accession to the throne as Henry IV.⁴² Earl Humphrey's widow held one-third of Nuthampstead in dower.⁴³ Thomas of Woodstock, Duke of Gloucester, held one-third in right of his wife⁴⁴ and the other third from 1396 onwards by grant of Henry then Earl of Derby, who became Duke of Hereford in right of his wife.⁴⁵ The Duke of Gloucester died in September 1397,⁴⁶ and his widow retained her third until her death in 1400.⁴⁷ In 1407, after Henry's accession to the throne, he agreed with Anne formerly wife of Edmund Earl of

¹⁶ Inform. from Messrs. Crossman and Prichard.

¹⁷ Assize R. 323, m. 45, 325.

¹⁸ Cal. Chart. R. 1257-1300, p. 146.

¹⁹ Cal. Pat. 1292-1301, p. 462.

²⁰ There was woodland for 100 swine at Newsells in 1086 (*V.C.H. Herts.* i, 329b).

²¹ Feet of F. Herts. Hil. 1 Edw. VI; Pat. 1 Edw. VI, pt. v, m. 21.

²² Feet of F. Herts. Hil. 24 Eliz.

²³ *V.C.H. Herts.* i, 339b.

²⁴ *Ibid.* 329b.

²⁵ The name 'Erlesbury' was applied to the manor-house in 1422 (Duchy of Lanc. Mins. Accta, bde. 42, no. 820).

²⁶ *V.C.H. Herts.* i, 331.

²⁷ *Cart. Mon. S. Johannis de Colecestria* (Roxburgh Club), 382; cf. *Red Bk. of Exch.* (Rolls Ser.), 345.

²⁸ *Cart. Mon. S. Johannis de Colecestria*, loc. cit.

²⁹ *Ibid.* 174. The charter was confirmed by Fulk Nuers and Rodbert le Muine husband of Clarice (possibly one of Ralph's daughters). Another daughter may have been Margaret wife of Roger Bernard (*ibid.* 175).

³⁰ *Ibid.* 41.

³¹ *Ibid.* 176.

³² Assize R. 323, m. 1 d.; *Hund. R.* (Rec. Com.), i, 193.

³³ Assize R. 323, m. 1 d.; Feet of F. Div. Co. 7 Edw. I, no. 1.

³⁴ *Cal. Pat.* 1313-17, pp. 283-4; Duchy of Lanc. Anct. D. box 6.

³⁵ *G.E.C. Complete Peerage*, iv, 215.

³⁶ Duchy of Lanc. Anct. D. L 1759.

³⁷ Chan. Inq. p.m. 10 Edw. III (1st nos.), no. 62; Escheators' Enr. Accts. (Exch. L.T.R.), 9 Edw. III, no. 2.

³⁸ Duchy of Lanc. Deeds in Boxes, box A, no. 57. It was possibly this Earl Humphrey who exchanged Nuthampstead for life with Humphrey de Verdun in return for Depden Manor, co. Suffolk (Duchy of Lanc. Anct. D. L 1471).

³⁹ Assize R. 323, m. 1 d.

⁴⁰ Chan. Inq. p.m. 37 Edw. III, no. 10.

⁴¹ *Ibid.* 3 Ric. II, no. 12. Their father had granted a life interest in the manor to Sir John de Gildesburgh, kt.

⁴² *G.E.C. Complete Peerage*, iv, 215.

⁴³ Duchy of Lanc. Misc. Bks. xvi (3), p. 78.

⁴⁴ Chan. Inq. p.m. 21 Ric. II, no. 29.

⁴⁵ *Cal. Pat.* 1396-9, p. 13; Close, 21 Ric. II, pt. ii, m. 7; cf. Duchy of Lanc. Anct. D. LS 170.

⁴⁶ Chan. Inq. p.m. 21 Ric. II, no. 29.

⁴⁷ *Ibid.* 1 Hen. IV, no. 49.

Stafford, and then of William Bouchier, the only surviving daughter and co-heir of Thomas of Woodstock by his wife Eleanor, that one-third of the manor should be retained in dower by the Dowager Countess of Hereford, one-third by William Bouchier, and one-third by the king in right of his former wife.⁴⁸ This arrangement was altered in 1421, when partition of the Bohun inheritance was made between the Countess of Stafford and Henry V, as son and heir of Henry IV by Mary Bohun. The whole manor of Nuthampstead was then included in the king's share of the estate,⁴⁹ and in November 1422 Nuthampstead was assigned to Queen Katherine, widow of Henry V, as part of her dower.⁵⁰ It formed in succession part of the jointure of Margaret, queen of Henry VI,⁵¹ and

Nuthampstead.⁵⁷ The latter descended in the Chester family to Edward Chester (see Royston), son of Sir Robert Chester who died in 1640.⁵⁸ His son Edward bought Newsells Manor. Nuthampstead passed with Newsells from the Chesters to the Jennings and has since descended with Newsells (q.v.).

The manor was always accounted a part of the honour of Mandeville and parcel of the earldom of Essex.⁵⁹ A capital message existed between 1141 and 1151, when Roger son of Ralph Nuers set up a private chapel there.⁶⁰ A house existed, probably on the same site, in January 1335-6.⁶¹ The old hall at Earlsbury was pulled down and a new hall built largely of timber grown within the manor in 1422.⁶² The lords of Nuthampstead (sometimes styled Nuthampstead Barkway)⁶³ held view of frankpledge in Barkway, but in 1347 the common fine was paid to the lord of Nuthampstead, while the lord of Rokey received the amercements.⁶⁴

The manor of *BERWICK* in Nuthampstead (Berwyk, Berewyke by Barkway, xiv-xvi cent.; Barwike, xvi-xviii cent.) was held of Great Hormead,⁶⁵ of which its name denotes it an outlying member. Hence it may be the hide and a half of land in Barkway held of Edgar Atheling by Goduin in 1086,⁶⁶ since Goduin also held of Edgar the manor of Great Hormead.⁶⁷ The holding of John de Sanford, lord of Hormead, early in the 13th century included Nuthampstead, held with Hormead (q.v.) by serjeanty of the Queen's Chamber.⁶⁸ About 1240 the abbey of Colchester made an agreement with the priory of Blackmore as to the tithes from the demesne lands of Sir Gilbert de Sanford, kt., in Nuthampstead.⁶⁹ Alice daughter of Gilbert de Sanford married Robert de Vere fifth Earl of Oxford.⁷⁰ Upon the marriage of their daughter Joan with William son of John de Warenne Earl of Surrey they settled the 'manor of Nuthampstead' on William and Joan and the heirs of Joan, saving to themselves a life interest if William and Joan should predecease them.⁷¹ William de Warenne was slain in a tournament at Croydon 15 December 1285; his widow died in 1293.⁷² The manor then reverted to the Earl of Oxford and his wife for life, in accordance with the terms of the settlement.⁷³ His wife survived him and died 7 September 1317.⁷⁴ The manor evidently reverted to John Earl of Surrey, the only son and heir of William and Joan de Warenne. His heir was Richard Fitz Alan Earl of Arundel, son of his sister Alice.⁷⁵ The Earl of Arundel granted 'the manor of Berwick' for life to Peter Shank.⁷⁶ In 1376 the earl's son Richard Earl of Arundel, one of the Lords Appellant, alienated

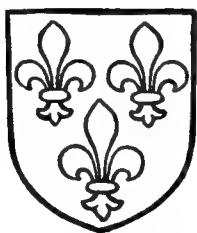

KATHERINE of FRANCE.
Azure three fleurs de lis or.

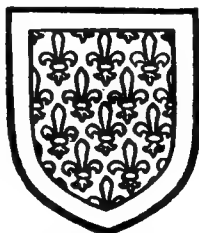

MARGARET of ANJOU.
OLD FRANCE with a border gules.

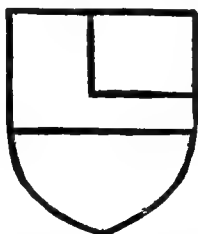

ELIZABETH WYLVILLE.
Argent a fesse and a quarter gules.

Elizabeth, queen of Edward IV.⁵² The latter was deprived of her dower by Richard III.⁵³

In the May following his accession Henry VII let the manor to John Grey for seven years.⁵⁴ The king's tenants disputed the power of the Prior of Royston to inclose certain ground over which they had common rights in 1503.⁵⁵ In 1545 Robert Chester and his wife Katherine, who had already purchased Royston Priory Manor with Cockenach in Barkway,⁵⁶ acquired from the Crown the manor of

⁴⁸ Duchy of Lanc. Misc. Bks. xvi (3), p. 78; cf. Chan. Inq. p.m. 4 Hen. IV, no. 41. ⁴⁹ *Parl. R.* iv, 136a.

⁵⁰ Duchy of Lanc. Misc. Bks. xviii (2), 49. ⁵¹ *Parl. R.* v, 118b.

⁵² Feet of F. Div. Co. Edw. IV, file 76, no. 102.

⁵³ Stat. 1 Ric. III, cap. 15.

⁵⁴ Duchy of Lanc. Misc. Bks. xxi, p. 170.

⁵⁵ Duchy of Lanc. Entry Bk. of Orders and Decrees, iii, fol. 227b.

⁵⁶ See *V.C.H. Herts.* iii, 260.

⁵⁷ Duchy of Lanc. Misc. Bks. xxii, 217.

⁵⁸ Chan. Inq. p.m. (Ser. 2), clxx, 51; clxxxvi, 8; ccccxciv, 65.

⁵⁹ *Ibid.* 10 Edw. III (1st nos.), no. 62;

37 Edw. III, no. 10. The statement, made in 1380, that the manor was held of the Earl of Oxford was probably an error (*ibid.* 3 Ric. II, no. 12). The earl was overlord of Cockenach in Nuthampstead (q.v.).

⁶⁰ *Cart. Mon. S. Johannis de Colecestria* (Roxburghe Club), 382.

⁶¹ Chan. Inq. p.m. 10 Edw. III (1st nos.), no. 62.

⁶² Duchy of Lanc. Mins. Accts. bdle. 42, no. 820.

⁶³ Duchy of Lanc. Ct. R. bdle. 77, no. 999. Possibly this was to distinguish it from Berwick in Nuthampstead.

⁶⁴ *Ibid.* bdle. 64, no. 805.

⁶⁵ Chan. Inq. p.m. (Ser. 2), xxviii, 69; xxxviii, 25.

⁶⁶ *V.C.H. Herts.* i, 341a.

⁶⁷ See under Great Hormead.

⁶⁸ *Red Bk. of Exch.* (Rolls Ser.), ii, 507.

⁶⁹ *Cart. Mon. S. Johannis de Colecestria* (Roxburghe Club), 569.

⁷⁰ G.E.C. *Complete Peerage*, vi, 164.

⁷¹ Feet of F. Div. Co. 13 Edw. I, no. 19.

⁷² G.E.C. *Complete Peerage*, vii, 328.

⁷³ *Cal. Clois.* 1288-96, p. 336.

⁷⁴ G.E.C. *Complete Peerage*, vi, 164.

⁷⁵ *Ibid.* vii, 329.

⁷⁶ *Cal. Pat.* 1396-9, p. 578. Apparently the manor of Berwick held by Henry Duke of Lancaster (see Chauncy, op. cit. 101) lay in Wiltshire (Chan. Inq. p.m. 35 Edw. III [1st nos.], no. 122).

A HISTORY OF HERTFORDSHIRE

his life interest in the manor to John Chamberlain, who transferred his rights to John Boston of Boston.

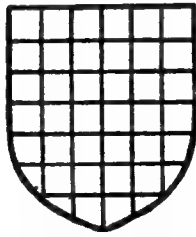

WARENNE. *Checky or and azure.*



FITZALAN. *Gules a lion argent.*

Boston's title was extended by the Crown to a life interest 5 May 1398, shortly after the forfeiture of the earl's estates.⁷⁷ These were restored in October 1400 to Thomas son of the late earl,⁷⁸ and he gave Berwick to his messenger (*nuncius*) John Ryggol for life.⁷⁹ The latter was still living in July 1416.⁸⁰ The earl had died 13 October 1415, leaving as heirs three sisters.

About the year 1439 Berwick was in the possession of Sir John Fray, chief baron of the Exchequer, who acquired a considerable estate in the county by purchase and probably bought this manor also.⁸¹ It was afterwards held by Anne wife of Richard Southwell, who in 1475 joined with her husband in a conveyance to Henry and Robert Colet and others and to the heirs of Henry,⁸² who was afterwards Lord Mayor of London. Sir Henry's son and heir John Colet, the famous Dean of St. Paul's,⁸³ gave the manor in trust to the Mercers' Company for his chantry of Our Lady Patroness of Boys near his school in St. Paul's Churchyard.⁸⁴ The manor was evidently acquired by William Gery of Barkway and Bushmead after the suppression of Colet's chantry. Gery conveyed it in 1552 to William Plattfote of Beccles,⁸⁵ who evidently alienated to William Hillington, since in 1553 the latter sold to Thomas Hanchett of Albury, a rent of £8 being reserved to the school.⁸⁶

Hanchett sold in 1555 to George Hadley and his wife Mercy.⁸⁷ Early in the year 1584 George



COLET. *Sable a chevron between three hinds tripping argent with three rings argent on the chevron.*

Hadley transferred his rights to Wimond Cary,⁸⁸ who sold in 1595 to Henry Prannell, gentleman.⁸⁹ The manor has since descended with Newsells.

Cockenach (Cochenac, xi cent.; Cochenach, xii cent.; Cokenhache, xiii cent.; Cockenach, xiv-xvi cent.; Cokenhach or Cockenatch, xvi-xviii cent.) is an extensive district lying partly between Newsells and Nuthampstead, partly to the east of Nuthampstead on the Essex border. In 1086 Ansfrid held of Geoffrey de Bech 1 hide 12 acres in Cockenach, and the same Ansfrid held of Geoffrey 20 acres in the neighbouring parish of Barley.⁹⁰ Algar, one of Wigar's men, had held the land at Cockenach before the Conquest.⁹¹ A part of this land was apparently *LITTLE COCKENACH OR COCKENACH IN NUTHAMPSTEAD*.⁹² The 'manor of Cockenach' subsequently came into the possession of Ralph the Butler ('Pincerna'), together with other lands which had been held by Geoffrey de Bech.⁹³ Roger Burun held these of Ralph by service of two knights' fees. Between 1120 and 1135 the latter subenfeoffed Aubrey de Vere of them until Robert Burun should have paid to Vere £32 due to Ralph the Butler. Robert was then to enter upon the lands and the right of Vere and his heirs was to be limited to a mesne lordship between Burun and Butler.⁹⁴ A Robert Burun, possibly the Robert mentioned above, with his wife Beatrice, gave to the Abbot and to the convent of St. Gunwal at Montreuil 80 acres of land at Cockenach, upon which was built a chapel, while Robert Levegar and his son gave to the abbey thecroft and house (*mansio*) in which the chapel was built.⁹⁵ It is said that the abbot built (possibly rebuilt) the chapel as a chantry for the souls of all the faithful departed.⁹⁶ Robert Abbot of Montreuil acquired lands of the fee of Earl William (of Essex, d. 1227), lord of Nuthampstead, and he alienated these with Cockenach to the abbey of St. James, Walden, about 1221.⁹⁷ Roger Burun, son of Robert, in confirming to Walden Abbey 'the place called Cockenach with the chapel of St. Gunwal,' agreed to keep the chapel in repair and to provide vestments.⁹⁸ By 1343 the chantry had long ceased to exist,⁹⁹ but the monks of Walden retained their land in Cockenach and Nuthampstead¹⁰⁰ until the surrender of their house to the Crown in March 1537-8.¹ Early in the 16th century some part at least of their land was let to the Priors of Royston.² Cockenach was granted with Walden Abbey in 1538 to Sir Thomas Audley, kt., lord chancellor,³ by whom a settlement in tail was made

⁷⁷ *Cal. Pat.* 1396-9, p. 578.

⁷⁸ *Ibid.* 1399-1401, p. 134.

⁷⁹ *Chan. Inq. p.m.* 4 Hen. V, no. 54.

⁸⁰ *Ibid.*

⁸¹ *V.C.H. Herts.* iii, 229, 266, 273; *Inq. a.q.d.* file 448, no. 22.

⁸² Feet of F. Herts. 15 Edw. IV, no. 43. The identity of Anne Southwell is unknown. Possibly she was Fray's daughter who is elsewhere styled 'Agnes' (cf. *V.C.H. Herts.* iii, 229, 266, 273).

⁸³ *Chan. Inq. p.m.* (Ser. 2), xix, 31; *Exch. Inq. p.m.* (Ser. 2), file 295, no. 2.

⁸⁴ *L. and P. Hen. VIII*, i, 4659; *Chan. Inq. p.m.* (Ser. 2), xxviii, 69; xxxviii, 25.

⁸⁵ *Com. Pleas D. Enr. Hil.* 6 & 7 Edw. VI, m. 3.

⁸⁶ *Ibid.* Mich. 1 Mary, m. 15 d.

⁸⁷ Feet of F. Herts. East. 1 & 2 Phil. and Mary. William Ernste and his wife

Bridget were parties to this conveyance; cf. *ibid.* Mich. 3 & 4 Phil. and Mary.

⁸⁸ *Ibid.* Hil. 26 Eliz.

⁸⁹ *Ibid.* East. 37 Eliz. In the same year John Oliver and his wife Frances conveyed their right in the manor to Prannell (*ibid.* East. 37 Eliz.).

⁹⁰ *V.C.H. Herts.* i, 333b.

⁹¹ *Ibid.*

⁹² cf. Duchy of Lanc. Ct. R. bdle. 77, no. 999, where it is stated that the lands of the abbey of Walden lay within the 'leet and lordship' of Nuthampstead.

⁹³ viz. Hailey and Bengoe near Hertford (*Harl. Chart.* 46, I 30; see *V.C.H. Herts.* iii, 417, 425-6).

⁹⁴ *Harl. Chart.* 46, I 30.

⁹⁵ Dugdale, *Mon.* iv, 151.

⁹⁶ *Cal. Close*, 1343-6, p. 1.

⁹⁷ *Harl. MS.* 3697, fol. 194. In com-

pensation the abbey at Montreuil received 15 marks and a pension of 10s., which was afterwards released (*ibid.* fol. 13).

⁹⁸ *Ibid.* fol. 194. John Burun gave to Colchester Abbey land in Cockenach in a place called Ryshill next the land of Walden Abbey which 'Robert the Chaplain of Bokesworth' formerly held (*Cart. Mon. S. Johannis de Colecestria* [Roxburghe Club], 236-7).

⁹⁹ *Cal. Close*, 1343-6, p. 1. This return is probably in error in stating that Burun held of the Mandeville fee.

¹⁰⁰ *Pope Nich. Tax.* (Rec. Com.), 14.

¹ *V.C.H. Essex*, ii, 114.

² Duchy of Lanc. Ct. R. bdle. 77, no. 999.

³ *L. and P. Hen. VIII*, xiii (1), 1115 (23).

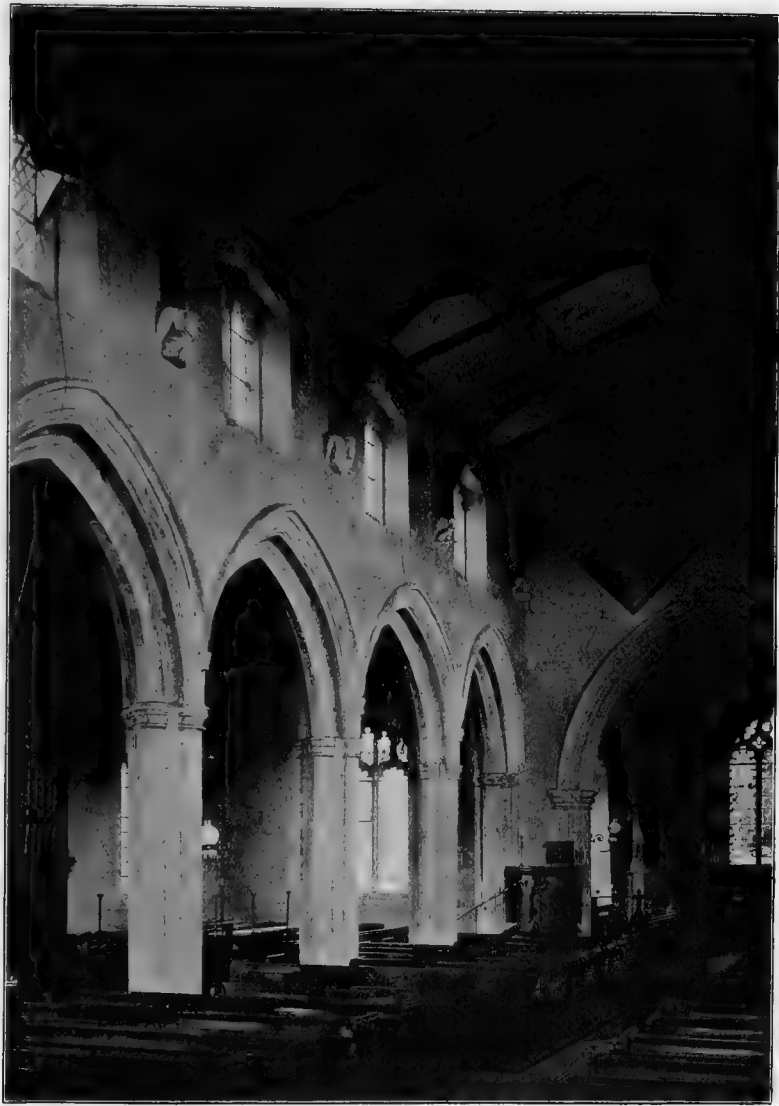

BARKWAY CHURCH : THE NORTH ARCADE

in the same year.⁴ It was evidently purchased by Sir Robert Chester⁵ and united to the 'manor of Cokenach,' which had belonged to Royston Priory.

The latter is probably identical with *GREAT COCKENACH* or *COCKENACH* in *BARKWAY*. The Prior of Royston acquired from William de Notton in 1354 a messuage, land and services in Cokenach.⁶ They had been given to Notton by John Earl of Oxford,⁷ to whom they had escheated by reason of the felony of Richard Bromley, a former tenant.⁸ They may be identical with the quarter knight's fee in Cokenach held by William Berking in 1303,⁹ since in 1309 William Berking and his daughter Idonea sought to replevy certain lands in Barkway against Alan son of Walter Bromley.¹⁰ Possibly the lands acquired by Royston Priory were that part of the holding of Geoffrey de Bech which Robert Burun had not included in his gift to the abbey of Montreuil.¹¹

The possessions of Royston Priory at the Dissolution included the manor of Cokenach, lands called Bermondseyes¹² and Margeryes in Nuthampstead and other lands in Cokenach set aside to the use of the sacristan.¹³ These were purchased, together with the site of the priory, by Robert Chester in 1540.¹⁴ Cokenach Manor then descended with Nuthampstead and subsequently with Newsells (q.v.).

The manor-house or Cokenach Park estate was separated from the manor about 1780, when it was purchased by Sir John Chapman, bart.¹⁵ His widow Dame Sarah Chapman bequeathed it to Dame Mary Willes, wife of Sir Francis Willes, who left it to her nephew William Henry Clinton, afterwards General Sir William Clinton, to hold in tail-male.¹⁶ His son Lieut.-Colonel Henry Clinton disentailed the property, which was purchased from his widow by Mr. Alexander Crossman, the present owner of the manorial rights, who resides at Cokenach.¹⁷

HEDLEYS or *HADLEYS* belonged to the college of St. John, Rotherham, co. York, founded by Thomas Rotherham, Archbishop of York.¹⁸ The grant was made in 1482, when the estate was conveyed by John Shuckburgh¹⁹ and his wife Clemency, daughter of John Horne, to the archbishop, William Sheffield, clerk, and others,²⁰ for the endowment of the college.²¹ It was possibly identical with the land held of the lord of Newsells by Ralph 'de Handley,' by service of a quarter-fee, about 1248.²² The college was

dissolved under the Act of 1547 and its lands were seized by the Crown.²³ Hedleys was purchased in 1550 by Robert Chester,²⁴ and thus became part of the estate consolidated by the Chesters in Barkway and its neighbourhood.²⁵

ROKEY (Rokeye, xiii-xv cent.; Rookey, xvi-xviii cent.) can be located off the road from Reed to Barkway. The manor was held by a certain Robert 'de Hilton,' who gave it to his son Alexander²⁶ de Hilton (or Hutton).²⁷ The latter claimed amendment of assize of bread and ale about 1287²⁸ and subsequently enfeoffed Hugh de Lancaster of the manor.²⁹ He was holding it in 1303,³⁰ and in 1306 a settlement was made on himself and his wife Maud and the heirs of Hugh.³¹ Maud survived her husband,³² who was dead in 1327.³³ His heir was his son John,³⁴ who was in possession of the manor in 1347.³⁵ It evidently remained in the family³⁶ until 1415, when Thomas son and heir of Edward de Lancaster sold it to John Woodward and others.³⁷ Maud Woodward was holding it in 1428.³⁸ It was subsequently acquired by the lord of Newsells Manor. It is said to have been settled in fee simple on Thomas Lord Scales.³⁹ In 1483 it was included with Newsells in the grant to the Duke of Norfolk of the lands which had lately belonged to Earl Rivers.⁴⁰ Its history is coincident with that of Newsells until 1546, when the Earl of Oxford sold it to William Gery of Barkway.⁴¹ By 1560 it had been acquired by the lord of Water Andrews, William Hyde, and his wife Elizabeth. At that date they conveyed both manors to Matthias Bradbury,⁴² from whom they were purchased by Sir William Petre in 1562.⁴³ In 1583 Sir John Petre, kt., sold them to Henry Prannell,⁴⁴ who had recently acquired Newsells (q.v.). He in 1589 bequeathed two-thirds of all his Hertfordshire manors to his wife Anne for life with remainder to his son Henry, who also held the other third at his father's death. If the son should die without issue two-thirds of the manors of Rokey and Water Andrews were to pass to Joan Brooke,



LANCASTER. *Argent two bars gules and a quarter gules with a leopard or therein.*

⁴ *L. and P. Hen. VIII*, xiii (2), 491 (6).

⁵ Chan. Inq. p.m. (Ser. 2), clxx, 51.

⁶ Add. MS. 5843, fol. 247; *Cal. Pat.* 1354-8, p. 53.

⁷ Add. MS. 5843, fol. 247.

⁸ Chan. Inq. p.m. 26 Edw. III (2nd nos.), no. 4; cf. *Abbrev. Rot. Orig.* (Rec. Com.), ii, 225; *Cal. Pat.* 1350-4, p. 349.

⁹ *Feud. Aids*, ii, 431.

¹⁰ *Cal. Close*, 1307-13, p. 136; cf. *Cal. Pat.* 1307-13, p. 419.

¹¹ Thus the overlordship of the Veres Earls of Oxford would be explained. Geoffrey's holding was \bar{r} hide 12 acres, i.e. about 132 acres. Burun gave to Montreuil 80 acres only.

¹² Evidently the land from which a rent of 13s. 4d. was due to Bermondsey Priory (*Pope Nich. Tax.* [Rec. Com.], 14). The land was farmed from Bermondsey Priory by the Priors of Royston (Duchy of Lanc. Ct. R. bdle. 77, no. 999).

¹³ Mins. Accts. 28 & 29 Hen. VIII,

no. 85. It is noteworthy that a suit-fine was due to the Earl of Oxford.

¹⁴ *L. and P. Hen. VIII*, xvi, g. 379 (60).

¹⁵ Clutterbuck, op. cit. iii, 369.

¹⁶ Abstract of title communicated by Messrs. Crossman and Prichard; Cussans, *Hist. of Herts. Edwinstree Hund.* 26.

¹⁷ Inform. from Messrs. Crossman and Prichard.

¹⁸ Pat. 4 Edw. VI, pt. ix.

¹⁹ cf. the account of Water Andrews below.

²⁰ Feet of F. Div. Co. 22 Edw. IV, no. 142.

²¹ Guest, *Hist. Notices of Rotherham*, 138.

²² *Cal. Inq. p.m. Hen. III*, 38.

²³ Guest, op. cit. 147.

²⁴ Pat. 4 Edw. VI, pt. ix.

²⁵ See above.

²⁶ De Banco R. 281, m. 32 d.

²⁷ See Assize R. 325.

²⁸ Ibid.; cf. the account of view of frankpledge at Nuthampstead.

²⁹ De Banco R. 281, m. 32 d.

³⁰ *Feud. Aids*, ii, 431.

³¹ De Banco R. 281, m. 32 d.; Feet of F. Herts. 34 Edw. I, no. 426.

³² De Banco R. 281, m. 32 d.

³³ Ibid. 269, m. 22.

³⁴ Ibid.; cf. De Banco R. 281, m. 32 d. A John de Lancaster was concerned with William and John of Rokey in a night attack on the Earl of Pembroke at Barkway in 1346 or 1347 (*Cal. Pat.* 1345-8, p. 306).

³⁵ Duchy of Lanc. Ct. R. bdle. 64, no. 805.

³⁶ This John de Lancaster had a son John (*Cal. Pat.* 1345-8, p. 306).

³⁷ Feet of F. Herts. 3 Hen. V, no. 14.

³⁸ *Feud. Aids*, ii, 445.

³⁹ Chan. Inq. p.m. (Ser. 2), i, 37.

⁴⁰ *Cal. Pat.* 1476-85, p. 365.

⁴¹ Deed printed by Cussans, op. cit. *Edwinstree Hund.* 22.

⁴² Feet of F. Herts. East. 2 Eliz.

⁴³ Ibid. East. 4 Eliz.

⁴⁴ Ibid. East. 25 Eliz.

A HISTORY OF HERTFORDSHIRE

daughter of Henry Prannell, the father, and to her husband Robert Brooke, with remainder to Henry Brooke, their son, who was the godson of the elder Prannell.⁴⁵ 'Rookey Mead' was occupied by Robert Brooke in 1595, and was a source of discord between him and his brother-in-law Henry Prannell.⁴⁶ In spite of the will of Henry Prannell the elder, both Rokey and Water Andrews were retained with Newsells by the widow of Henry Prannell the younger and passed to her kinsman Lord Maltravers.⁴⁷ The manor has since descended with Newsells (q.v.). The freehold of Rokey now belongs to Mr. J. W. Sworder.

A 'manor of Barkway' held with Rokey by Thomas Lord Scales⁴⁸ was possibly acquired by the lords of Newsells during the 15th century. With Rokey it was said to be held of Sir William Say, kt., in 1513.⁴⁹ It and Rokey may, therefore, have been originally a part of the Mandeville fee of 1086.⁵⁰ It descended with Rokey and Newsells until March 1531-2, when it was among the lands assigned to the Earl of Oxford,⁵¹ but it is not definitely mentioned either in the conveyance of Newsells to Henry Prannell⁵² or in that of Rokey to William Gery.⁵³ It may, however, be identical with the 'other lands' in Barkway included in Gery's purchase.

The manor of *WATER ANDREW'S* (Water Andretys, Water Androws or Walter Andrewes, xvi cent.) was held about 1519 by John Shuckburgh, lord of the neighbouring manor of Chamberlains in Reed (Odey Hundred).⁵⁴ It continued in the possession of the successive lords of Chamberlains until 1560, when William Hyde and his wife Elizabeth sold it with Rokey to Matthias Bradbury.⁵⁵ Its subsequent history is coincident with that of Rokey⁵⁶ (q.v.).

The *RECTORY MANOR* evidently originated in lands acquired by the abbey of Colchester with the church (q.v.). The charter of Eudo Dapifer mentions only 'the church of Newsells,'⁵⁷ but Ralph Nuers, lord of Nuthampstead, released to the abbey 'all his right in whatever belonged to the church quit of all service,' and gave the abbey 11 acres of his own fee.⁵⁸ Between 1195 and 1238 the 'fee' of the church included land near the market-place.⁵⁹ The rectory fee was retained by the abbey until its dissolution.⁶⁰ It was evidently customary for the lessee of the house and demesnes to entertain the abbot yearly when he held courts at Barkway.⁶¹ In 1544 William Gery of Barkway had a grant of this manor from the Crown.⁶² He transferred it with Berwick to William Plattfote,⁶³ but the latter reconveyed to him and

joined with him in a sale to Henry Ward of Postwick, co. Norfolk, in 1554.⁶⁴ Edward Ward of Bixley, son of Henry, settled this manor on his youngest son Edward⁶⁵ and died 1 May 1583.⁶⁶

Edward the younger entered upon the Rectory Manor soon afterwards.⁶⁷ He was constrained to sell it by reason of a numerous family.⁶⁸ It was purchased by Susanna widow of Sir Richard Saltonstall and by her son Peter, afterwards Sir Peter Saltonstall, kt.⁶⁹ Anne daughter of Sir Peter married Sir Edward Chester, kt.,⁷⁰ and the Rectory Manor descended with the other manors held by the Chesters.

The church of *ST. MARY MAG-CHURCH DALENE* consists of chancel 35 ft. 6 in.

by 16 ft., nave 67 ft. by 20 ft., north and south aisles each 16 ft. wide, west tower 14 ft. square and modern south porch and north vestry and organ chamber, all internal dimensions. It is built of flint rubble with stone dressings, the whole of the facings being modern; the roofs are tiled.

The chancel appears to have been built in the 13th century and the chancel arch rebuilt early in the 15th century. The nave and aisles are of 15th-century date. The west tower was almost entirely rebuilt in 1861. The vestry and organ chamber on the north side of the church and the south porch are modern. The church was thoroughly restored in 1861, and a great deal of the internal stonework reworked or renewed.

The east window of the chancel is of three lights with modern tracery; the inner jambs are original. In the north wall are two blocked lancets of modern stonework, but probably copies of the original 13th-century lights; there is also a three-light window of modern stonework. In the south wall are a 13th-century lancet, the outside stonework of which is modern, a low-side window of two cinquefoiled lights, all of modern outer stonework, but with old inner jambs, and a modern doorway. In the same wall is a double piscina of 13th-century character, but of modern stonework.⁷¹ The early 15th-century chancel arch is of two moulded orders, with moulded jambs dying on splayed base, and moulded capitals. The roof is modern.

The north and south arcades of the nave consist of six bays, with arches of two moulded orders, with moulded labels on both sides, piers composed of four semi-octagonal shafts with hollows between, and with moulded capitals and bases; the labels have carved grotesque stops. The details of the two arcades are similar, except for a slight difference in the section of the capitals. All the work is of 15th-century date.

⁴⁵ Chan. Inq. p.m. (Ser. 2), ccxxv, 64.

⁴⁶ Proc. of Ct. of Requests, bdle. 33, no. 71.

⁴⁷ See under Newsells.

⁴⁸ Chan. Inq. p.m. (Ser. 2), i, 37.

⁴⁹ Ibid. xxviii, 68.

⁵⁰ Cf. the account of Sawbridgeworth in Braughing Hundred; see also the fee of William Odburghville in Barley.

⁵¹ See above under Newsells.

⁵² Feet of F. Herts. East. 21 Eliz.

⁵³ Cussans, op. cit. *Edwinstree Hund.* 22.

⁵⁴ Close, 11 Hen. VIII, no. 2. For the Shuckburgh family cf. the account of Hedleys above and De Banco R. 269, m. 22.

⁵⁵ Feet of F. Herts. East. 2 Eliz.

⁵⁶ It is perhaps on this account that county historians following Chauncy

identify Water Andrews with Rokey. They were certainly distinct in the early part of the 16th century and are so still (Ct. Bks. *penes* Messrs. Crossman and Prichard).

⁵⁷ *Cart. Mon. S. Johannis de Colecestria* (Roxburghe Club), 3.

⁵⁸ Ibid. 173.

⁵⁹ Ibid. 630.

⁶⁰ Dugdale, *Mon.* iv, 613; Ct. R. (Gen. Ser.), portf. 177, no. 3.

⁶¹ Mins. Accts. Hen. VIII, no. 976.

⁶² *L. and P. Hen. VIII*, xix (1), 610 (52).

⁶³ Com. Pleas D. Enr. Hil. 6 & 7 Edw. VI, m. 3.

⁶⁴ Ibid. Mich. 1 & 2 Phil. and Mary, m. 5; Feet of F. Herts. Mich. 1 & 2 Phil. and Mary.

⁶⁵ Recov. R. East. 14 Eliz. rot. 638; Chan. Inq. p.m. (Ser. 2), ccii, 182.

⁶⁶ Chan. Inq. p.m. (Ser. 2), ccii, 182.

⁶⁷ Pat. 27 Eliz. pt. ix, m. 22.

⁶⁸ Ibid. 2 Chas. I, pt. xxiii, no. 11. Disputes concerning the title may also have influenced him (Chan. Proc. Eliz. W xi, 22).

⁶⁹ Feet of F. Herts. Hil. 43 Eliz.; Hil. 44 Eliz.; Hil. 45 Eliz.; Pat. 2 Chas. I, pt. xxiii, no. 11; cf. Chan. Proc. (Ser. 2), bdle. 429, no. 3; Pat. 44 Eliz. pt. xxvi, m. 8.

⁷⁰ M. I. in the chancel.

⁷¹ There was probably an Easter sepulchre in the chancel; in 1498 John Homsted left money to the light of the Holy Sepulchre in Barkway Church (P.C.C. 16 Horne).



BARKWAY MANOR-HOUSE FROM THE SOUTH-EAST



BARLEY : THE TOWN HOUSE FROM THE SOUTH-WEST

The clearstory windows are of two cinquefoiled lights of modern stonework. The roof is modern, but the carved stone corbels supporting the trusses are of 15th-century date; they comprise figures of angels with musical instruments and shields and some grotesques. In the south-east angle of the nave is the doorway to the rood stairs set in a splay.

The east, west and three side windows of the north and south aisles and the corresponding windows of the south aisle are of three lights with traceried heads; they are of 15th-century character, but all of modern stonework. The south doorway has a four-centred arch with continuous mouldings stopping on a splayed base; it is of 15th-century date, but the stone has been reworked. Near the east end of the south aisle is a small piscina with pointed arch, wave-moulded on edge. The roofs of the aisles are modern, but the carved stone corbels under the trusses are of 15th-century date, and are similar in character to those under the nave roof. The south porch is modern. The west tower⁷² was rebuilt in 1861, all but the archway into the nave; it is of 15th-century date, with an arch of two moulded orders, the outer order continuous, the inner on round engaged shafts with moulded capitals and bases. Leaves are carved on the angles of the capitals, the upper members of which are octagonal on plan. The original wooden ladder to the belfry still exists. The font and all the fittings are modern.

On the south wall is a brass with figures of a man, his two wives and four daughters, with inscription to Robert Poynard, 1561. On the chancel floor is a brass inscription to Anna wife of John Rowley, 1613. On the north chancel wall is a tablet to Susanna wife of Robert Castell. On the floor are slabs to Anna second wife of John Rowley, 1650, Ann wife of Sir Edward Chester, 1645, and to Humfrey Boughton of Warwickshire, 1637. There are several tablets and slabs of the 18th century in the chancel, and under the tower is a large monument to Admiral Sir John Jennings, 1743. In the east windows of the north and south aisles are fragments of 15th-century glass, consisting of portions of a Jesse window and a mixed collection of saints and angels, fragments of inscriptions and heraldic devices.

There are eight bells: the first to the sixth are all by John Briant, 1797, the sixth being also inscribed 'Gloria Deo in Excelsis.' The above form the ring, besides which there is a small bell by James Bartlett, 1698, and another bell, not hung, inscribed 'Ave Maria Gracia Plena.' It bears the stamp of the Bury St. Edmunds foundry, but is undated; it is probably of 15th-century date.

The communion plate consists of cup and cover paten, two plates and a flagon, all of 1714; also a small silver-gilt cup, 1807, presented in 1901.

The registers before 1812 are as follows: (i) all

entries 1538 to 1699; (ii) baptisms and burials 1697 to 1810, marriages 1697 to 1753; (iii) baptisms and burials 1811-12; (iv), (v) and (vi) marriages 1754 to 1775, 1776 to 1805 and 1805 to 1812 respectively. There is also a register of banns of marriage 1776 to 1805. A churchwardens' account book is preserved, dating from 4 & 5 Philip and Mary and kept until 1715.

In the garden of the vicarage were some fragments of richly carved and crocketed pinnacles of clunch from the church. These are about to be placed in the church. The old font of Reed Church, until recently in a garden at Reed Hall, has been brought to Barkway, and will also be preserved in the church. It has five shields carved with flowers and emblems.

There was a priest on the Mandeville fee in Barkway in 1086,⁷³ but it was Eudo Dapifer, lord of Newsells, who gave the church of 'Newsells,' elsewhere called 'Barkway,'⁷⁴ to Colchester Abbey,⁷⁵ and the gift was confirmed by Henry I and also by Stephen and his wife Maud as overlords.⁷⁶ A moiety of the church seems, however, to have been appurtenant to Nuthampstead Manor (of the Mandeville fee), since Ralph Nuers, lord of Nuthampstead, granted half the church to the abbey in the 12th century.⁷⁷

The right of presentation remained thenceforward with the successive lords of the Rectory Manor (q.v.) until the sale of that manor to Mr. Alexander Crossman (see Newsells). It was then reserved by the Hon. G. H. Douglas and is now held by his son Captain George Sholto Douglas.

The advowson was reserved to the Abbot of Colchester in the conventual leases of the demesne lands.⁷⁸

Only one-third of the tithes was included in Eudo's gift to Colchester Abbey.⁷⁹ The tithes of Newsells Manor had been given to the abbey of Sées.⁸⁰ In 1249, after the settlement of a dispute between the two abbeys, the Abbot of Colchester became perpetual lessee of the tithes due to Sées Abbey.⁸¹

At first the profits of the church were appropriated to the clothing of the monks.⁸² A vicarage was ordained by Bishop Gilbert of London (1163-87), and the rectorial tithes were then appropriated to the use of the guest-house of the monastery.⁸³ A house near the church was assigned to the vicar.⁸⁴

There was a gild or brotherhood belonging to the church which in 1498 is called the gild of St. Mary,⁸⁵ but by 1506 it had become the gild or fraternity of the Blessed Mary and St. Thomas the Martyr.⁸⁶

The following charities are administered under the provisions of a scheme of the Charity Commissioners

of 30 August 1907, under the title of the Barkway Non-ecclesiastical Charities, namely, the charities of

1. Sir Edward Chester, will, 1666, being a rent-charge of £4 issuing out of 2 a. of land at Barkway.

⁷² The tower seems to have been rebuilt or considerably repaired early in the 16th century. In 1517 John Pynnar left all his timber in Barkway and Newport to the church of Barkway, so that it should be used in things necessary as to the steeple (i.e. the tower) or to the bells in the steeple. He also left money for buying a copper cross and making the 'pulpit,' possibly the rood-loft and also a bell for the clock (P.C.C. 35 Holder). In 1506 William Wilde, vicar of Bark-

way, left £6 13s. 4d. to the repair of the church where it was most needed (ibid. 20 Adeane).

⁷³ *V.C.H. Herts.* i, 331a.

⁷⁴ *Cart. Mon. S. Johannis de Colecestria* (Roxburghe Club), 48.

⁷⁵ *Ibid.* 3.

⁷⁶ *Ibid.* 11, 49.

⁷⁷ *Ibid.* 173.

⁷⁸ *Mins. Accts. Hen. VIII.* no. 976.

⁷⁹ *Cart. Mon. S. Johannis de Colecestria* (Roxburghe Club), 48.

⁸⁰ *Ibid.* 547, 550.

⁸¹ *Ibid.* 547. The rent was renounced by Sées Abbey in 1305 (ibid. 577).

⁸² *Ibid.* 71.

⁸³ *Ibid.* 83.

⁸⁴ *Ibid.* 93; Lond. Epis. Reg. Gilbert, fol. 200.

⁸⁵ Will of John Homsted (P.C.C. 16 Horne).

⁸⁶ Will of William Wilde, 1506 (ibid. 20 Adeane) and will of John Pynnar, 1517 (35 Holder).

A HISTORY OF HERTFORDSHIRE

2. Sir Robert Chester, will, 1638, being a rent-charge of £5 4s. issuing out of land known as Rokey Wood and Lady Grove.

3. Edmund King, will, before 1679, consisting of 20 a. of land known as Upper Crixfield in Clavering, Essex, let at £14 8s. a year.

4. — Mills, mentioned in Parliamentary Returns of 1786, being a rent-charge of 13s. 4d. issuing out of land known as Bull's Croft in Barkway.

5. William Mores, will, 1526, consisting of two cottages and their sites, let on lease at £2 a year.

6. Thomas Payne, will, 1763, being a rent-charge of £2 issuing out of Newsells estate in Barkway.

7. John Stallibrass, will, 1818, endowed with £166 13s. 4d. consols with the official trustees, producing £4 3s. 4d. yearly.

8. Town Lands, consisting of 2 a. in Barkway, let at £6 a year.

9. Unknown donor's charity, mentioned in the Parliamentary Returns of 1786, consisting of two cottages in Barkway, let at £4 15s. yearly.

The net income of the charities is by the scheme directed to be applied for the general benefit of the poor in such manner as the trustees thereby appointed should consider most conducive to the formation of provident habits. In 1911 £5 was given to the school clothing club, £30 to the coal

club, £3 3s. to hospitals and £2 towards the expenses of patients.

In 1796 James Andrews, by his will, bequeathed to the vicar and churchwardens the sum of £300 consols, the dividends to be applied for the benefit of the poor who should be regular attendants at divine service in the parish church.

In or about 1820—as appears from an inscription on the donor's tomb—Thomas Talbot Gorsuch gave £300 stock (now consols), the dividends to be applied by the vicar and churchwardens on the same conditions as directed by the will of his worthy friend, the said James Andrews.

The sum of £600 consols is held by the official trustees in trust for these charities. The annual dividends, amounting to £12 10s., are, under a scheme of 30 August 1907, made applicable under the title of the Barkway Ecclesiastical Charity for the general benefit of the poor regularly attending divine service in the parish church.

In 1909 three almshouses for women of over sixty years of age born or living in Barkway, members of the Church of England, were built by the late Mrs. Dudding and afterwards endowed by her, to perpetuate the memory of her great-grandfather John Stallibrass (see no. 7 above).

For the Free School see article on Schools.⁸⁷

BARLEY¹

Berlai (xi cent.); Berle, Berleye (xii–xiv cent.); Berle, Berlee or Barley (xv–xvi cent.).

The village of Barley lies on the chalk hills in the extreme north-east of the county and is distant about 3½ miles from Royston, where is the nearest railway station. Its eastern boundary is that of Cambridgeshire and follows for the most part the line of Water Lane and the deep gully known as Cumberden Bottom. Its northern limit is the Icknield Way, which also forms the Cambridgeshire boundary. The south and west boundary is almost entirely a field boundary.

The village is built along two roads meeting at right angles. The eastern arm leads past the church to Pickenage corner, the northern arm follows the line of the main road to Cambridge, which enters the parish from the neighbouring village of Barkway and traverses Cumberden Bottom to the north of the village. In the village are several thatched and plastered cottages and the manor-house of Hoares stands opposite the church. On the same side of the road is the Town House, formerly called the Guild-hall, and sometimes styled the Church House,² which faces the north side of the church. It appears to have been erected shortly before 1540, and is a two-storied building of timber framing covered with plaster; the roof is tiled, the upper story overhangs, and at the east end on the south front is a small wing containing a straight stair with solid steps to the upper floor. A north wing was added late in the 17th century, making the building L-shaped. The ground story was formerly used as an almshouse, and is divided into a number of small rooms, the

outer doorways to which have wood frames with four-centred arches. At the west end is a heavy brick chimney with sloping offsets. The upper floor is a hall with plain trussed roof, having curved ogee struts and braces. The dormer windows which light the hall are modern. This house was acquired before 1623 by the lords of Abbotsbury Manor.³ The Fox and Hounds Inn, formerly the 'Black Swan,' is reputed to have had some connexion with Dick Turpin. It is a small timber-framed and plastered building standing in the middle of the village on the west side of the main road. It is of early 17th-century date; the roof is thatched. The house is L-shaped on plan and has a projecting upper story; the old wide fireplaces have been filled in and the interior has been much altered, but a few 17th-century moulded beams still remain. Across the road stretches a beam on which are flat wooden figures of hounds and horsemen in full cry after a fox. By the side of the main road, about 250 yards west of the church, is a small wooden building called the Cage, which was formerly the village 'lock up.' It is built of upright timbers placed about 5 in. apart, with boarding between; it is about 7 ft. square and about 6 ft. 6 in. to the eaves. The slated roof is pyramidal and is finished at the apex with a moulded terminal. It is now used as a shed for road-menders. It was probably not erected earlier than the end of the 17th century. It is said to have contained at one time chains attached to a central post. The Cage may have belonged to the manor of Greenbury, the site of the manor-house of which is to the west of the Cambridge Road. The manor-house⁴

⁸⁷ *V.C.H. Herts.* ii, 102.

¹ This parish was transferred from Edwinstree Hundred to Odsey Hundred

in 1841 (*Sess. R.* [Herts. Co. Rec.], ii, 427).

² *Chan. Inq. p.m.* (Ser. 2), cccclxxxix, 60.

³ *Ibid.*

⁴ See below; Feet of F. Herts. Trin. 44 Eliz.

was apparently standing in 1602. A free school existed in the parish before 1700.⁵

Beyond the church Willow Lane, styled in the 15th century Willow Street,⁶ leads in a south-easterly direction towards Mincingbury manor-house. It meets the Bogmoor Road at the hamlet of Shaftenhoe End, called in the 13th century 'Scarpelho.'⁷ Here a few cottages dating from the early part of the 17th century are clustered about the Big House or Freeman's, built about 1624 and said to be the manor-house of 'Burnels.' It is a timber-framed building covered with plaster and stands on foundations of thin bricks; the roofs are tiled. The house is of two stories with attics and is F-shaped on plan; the main building runs east and west and measures about 53 ft. by 19 ft. 6 in. On the south side at its eastern end is a wing with a brick chimney at the south end; in the centre of the south side is a small projecting staircase wing of two stories. The hall, which occupied a large part of the main building, is now divided into rooms, but the wide fireplace remains with carved wood lintel and bracketed shelf, also a little 17th-century panelling. The ceiling joists have moulded edges. The exterior of the house on the east, north and west fronts has been modernized and the central chimney on the main block rebuilt. At the end of the south wing is a chimney built of 2-in. bricks, the sloping offsets of which are masked by bricks cross-stepped, in a manner similar to many other chimneys in Hertfordshire; the chimney stack has two square shafts set diagonally. The staircase projection on the south side has a single window under a projecting gable with a moulded beam supported at either end by a carved wood bracket representing a satyr playing on a long pipe; between the window and the projecting beam above is the following inscription carved in raised letters:—

'So God may still me blesse
I care the lesse
Let envy say her worst
And after burst.'

At one end of the inscription are the initials W.L. and at the other the date 1624, at which date the house was probably erected. An adjoining timber-framed and plaster cottage with thatched roof has worn remains of 17th-century ornamental plaster bands between the windows of the ground and upper stories externally; one band consists of alternate squares and ovals, another has a row of lozenges with a half-circle above each.

The farm-house of Mincingbury, about 300 yards to the east, has been almost entirely rebuilt, but adjoining it is a large mediaeval barn about 82 ft. long by 33 ft. wide. It is timber-framed on brick foundations and has heavy queen-post roof trusses; the exterior has been renewed.

Abbotsbury, a fourth manor-house, lies in an

isolated position in the south of the parish. It is now a farm-house, in the occupation of Mr. J. Loder. There are remains of a homestead moat with an entrenchment on its southern side. It was doubtless on his demesne lands here that the Abbot of Colchester had the 'chapel in Adgaeslawe,' which was confirmed to him by Roger Bishop of London in 1237.⁸

Barley is well watered both by Cumberden Bottom and by a tributary of the Cam called Wardington Bottom. There are numerous ponds and at Mincingbury is a fish-pond. The Mincingbury oak wood was cut down at the latter end of the 18th century.⁹ The parish is on the border of the Essex woodland, and an early 13th-century charter mentions assart called 'Wydeheye' within the manor of Mincingbury.¹⁰ There are, however, only about 99 acres of woodland out of a total area of 2,725 acres. Rather more than 400 acres are grass and about 2,160 acres are arable land.^{10a} The open fields were inclosed under an Act of 1809.¹¹ 'Eldebury,' or 'Oldbury,' was an open field appurtenant to Mincingbury.¹²

The manor of *ABBOTSBURY* or *MANORS ROWLETT'SBURY*¹³ was held by the abbey of St. John of Colchester.¹⁴ It is evidently identical with the 'land or manor of Algaeslawe or Aedgaeslawe' in Barley granted to the abbey by Hamo de St. Clare and his son Hubert in 1137.¹⁵ Hamo and his son made this gift for the health of their souls and those of Gunnora wife of Hamo and of Eudo Dapifer and Rose his wife.¹⁶ Hamo de St. Clare had evidently acquired the manor before 1123, when he assigned the tithes from 'his manor of Adgaeslawe' to Colchester Abbey, reserving only certain tithes given to Barley Church 'at the prayer of Uluric the priest.'¹⁷ Hamo is elsewhere found as successor of Eudo Dapifer; it is, therefore, probable that this holding is identical with the 2 hides and 20 acres in Barley held by Eudo in 1086. Half of this land was then held by Eudo in demesne and was worked with the five ploughs on his neighbouring demesne at Newsells.¹⁸ Before the Conquest half of Eudo's holding had been held by a sokeman of the king's, the other half by his brother who was a man of Tochi.¹⁹

The Abbot of Colchester obtained papal confirmation of his rights in 'Adgaeslawe' in 1179,²⁰ and in 1253 had a grant of free warren within the manor.²¹ It was possibly in error that the jurors of 1278 returned that the abbot held his manor of Barley of the gift of Ivo the Seneschal.²² In 1315 a message,

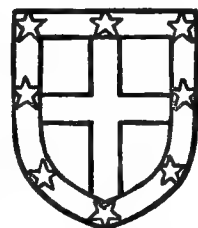

COLCHESTER ABBEY.
Gules a cross or and a border or with eight molets gules therein.

⁵ See below, under Charities, and Chauncy, op. cit. 98.

⁶ Ct. R. (Gen. Ser.), portf. 177, no. 1. It is probable that this was distinct from 'Wynewalstrete' (ibid.), which may be connected with the chapel of St. Gunwal in Barkway (q.v.); cf. 'Wynnels Grove' on the borders of Nuthampstead.

⁷ Lay Subs. R. bdlie. 120, no. 2.

⁸ *Cart. Mon. S. Johannis de Colecestria* (Roxburghe Club), 95.

⁹ Inform. supplied by Rev. J. Frome-Wilkinson. ¹⁰ Cott. MS. Jul. A i, 141.

^{10a} Statistics from Bd. of Agric. (1905).

¹¹ Priv. Act, 50 Geo. III, cap. 30 (not printed).

¹² Cott. MS. Jul. A i, 140; Ct. R. (Gen. Ser.), portf. 177, no. 1.

¹³ Chan. Inq. p.m. (Ser. 2), ccvi, 3.

¹⁴ Mins. Accts. Hen. VIII, no. 976.

¹⁵ *Cart. Mon. S. Johannis de Colecestria* (Roxburghe Club), 156, 157.

¹⁶ Ibid.

¹⁷ Ibid.

¹⁸ *V.C.H. Herts.* i, 329a, 329b.

¹⁹ Ibid. 329a.

²⁰ *Cart. Mon. S. Johannis de Colecestria*, 61; for confirmations by the Lanvaleys, Hamo's descendants, see ibid. 197, 198, and for other confirmatory grants see ibid. 67, 87, 95-7.

²¹ *Cal. Chart. R.* 1226-57, p. 418.

²² *Assize R.* 323, m. 45.

A HISTORY OF HERTFORDSHIRE

probably the manor-house, a carucate of land and 100s. rent in Barley were let for life to Bartholomew de Enfield.²³ The courts were probably reserved by the abbot as they were in the 16th century.²⁴ When each successive abbot entered upon his office he claimed 'palfrey money' from the tenants of this manor.²⁵ In 1533 William Grevill and his son John acquired a thirty-one years' lease of the manorial lands and agreed to entertain the abbot and his servants once yearly for two days and two nights, when they came to hold courts and to view the manor.²⁶

The abbey was suppressed in 1539,²⁷ and in April 1544 Edward Elrington and Humphrey Metcalf received its possessions in Barley in exchange for certain estates surrendered to the Crown.²⁸ They were evidently speculating in land. A court was held in Elrington's name in May 1544,²⁹ and on 1 July he joined with Metcalf in a sale to Sir Ralph Rowlatt, kt.,³⁰ who had recently inherited the manors of Mincingbury and Hoares (q.v.). In 1556 he settled his estates on himself and his heirs by his wife Dorothy,³¹ and afterwards he made a second settlement,³² doubtless in favour of his second wife Margaret³³; but he died childless in 1571.³⁴ He had bequeathed his estate in Barley to Sir Nicholas Bacon, Keeper of the Great Seal,³⁵ whose second wife Ann was sister to Rowlatt's second wife Margaret.³⁶ The nephews of Rowlatt, who were his heirs-at-law, released their rights in favour of Bacon before 1576.³⁷ The Lord Keeper died on 20 February 1578-9,³⁸ and was succeeded in the Barley estate by Anthony Bacon, the elder of his two sons by his wife Ann.³⁹ He sold it to Sir John Spencer, 'the rich Spencer, Lord Mayor of London,'⁴⁰ probably about the year 1593, when he was seriously embarrassed by his own debts and those of his brother Francis.⁴¹

At Spencer's death in March 1609-10 the estate passed to his daughter Elizabeth wife of William Lord Compton,⁴² afterwards created Earl of Northampton.⁴³ It was settled on their daughter Anne upon her marriage with Ulick Lord Dunkellin, son of Richard Earl of Clanricarde and St. Albans, in December 1622.⁴⁴ Ulick Earl of St. Albans and his wife were both active supporters of the royal cause in Ireland.⁴⁵ Their estates were sequestered and the manors in Barley were granted

to the Earl of Essex in September 1645 in consideration of his 'heroic valour, prudent conduct and unspotted fidelity' as captain-general of the Parliamentary forces.⁴⁶ He died on 14 September 1646,⁴⁷ and by an order of 1649 Barley was sold to satisfy the claims of Sir Robert Pye, who with the Earl of Northumberland had long had a mortgage on the estates of the Earl of St. Albans.⁴⁸ It was acquired by Sir Richard Lucy, bart., of Broxbourne, and Sir Edward Atkins, kt., afterwards chief baron of the Exchequer.⁴⁹ Lucy died at Broxbourne on 6 April 1667.⁵⁰ His son Sir Kingsmill Lucy, bart., and Sir Edward Atkins were dealing with Abbotsbury and other lands in Barley in the spring of 1671.⁵¹ Atkins afterwards sold to Thomas Kensey, citizen of London,⁵² from whom the estate was purchased before 1682 by Sir Thomas Byde⁵³ of Ware Park. He gave it to his son Ralph, whose son John Byde of Hunsdon inherited.⁵⁴ John Byde bequeathed it to John youngest son of Thomas

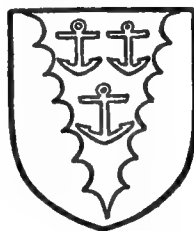

BYDE. Or a pile engrailed azure with three anchors or thereon.

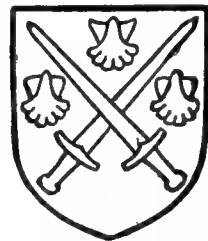

BRAND. Azure two crossed swords argent with their hilts or between three scallops or.

Byde of Ware Park,⁵⁵ who sold it to his eldest brother Thomas Plumer Byde.⁵⁶ It was purchased about 1770 by Thomas Brand of the Hoo.⁵⁷ His son Thomas Brand married Getrude Roper, who in 1794 became Lady Dacre, and their son Thomas Brand succeeded to the title on his mother's death in 1819. The manor descended with the successive Lords Dacre until 1901, when Henry Robert Viscount Hampden and Lord Dacre sold it to Mr. Alexander Crossman, the present lord of the manor.⁵⁸

²³ *Cal. Pat.* 1313-17, p. 289.

²⁴ *Mins. Accts.* Hen. VIII, no. 976.

²⁵ *Ct. R. (Gen. Ser.)*, portf. 177, no. 3, 4; cf. the fine for recognition called 'sadelsilver' levied from the customary tenants of the manor of Bishop's Stortford at the first court held after the vacancy of the bishopric of London.

²⁶ *Mins. Accts.* Hen. VIII, no. 976.

²⁷ *V.C.H. Essex*, i, 100.

²⁸ *L. and P. Hen. VIII*, xix (1), g. 442 (16).

²⁹ *Ct. R. (Gen. Ser.)*, portf. 177, no. 5.

³⁰ *L. and P. Hen. VIII*, xix (1), g. 812 (114, p. 508); *Close*, 36 Hen. VIII, pt. v, no. 3; *Ct. R. (Gen. Ser.)*, portf. 177, no. 2.

³¹ *Pat. 2 & 3 Phil. and Mary*, pt. v, m. 22.

³² *Chan. Inq. p.m. (Ser. 2)*, ccvi, 3.

³³ *Ibid.*

³⁴ *Ibid.*

³⁵ *Ibid.*; Bacon obtained pardon for the alienation in 1580 (*Pat. 22 Eliz.* pt. i, m. 13).

³⁶ *Dict. Nat. Biog.* under 'Ann Bacon.'

³⁷ Feet of F. Div. Co. Mich. 13 & 14

Eliz.; Mich. 17 & 18 *Eliz.*; Hil. 18 *Eliz.*

³⁸ *Dict. Nat. Biog.*; *V.C.H. Herts.* ii, 396.

³⁹ Feet of F. Herts. Trin. 34 *Eliz.*; *Recov. R. East.* 35 *Eliz.* rot. 42; cf. Chauncy, op. cit. 95. Chauncy's date for the court held at Barley in Anthony's name must be incorrect, unless he was holding it for his father.

⁴⁰ *Chan. Inq. p.m. (Ser. 2)*, cccxviii, 165; cf. *Dict. Nat. Biog.*; *G.E.C. Peerage*, vi, 72.

⁴¹ *Dict. Nat. Biog.*; cf. Feet of F. Herts. Trin. 34 *Eliz.*; *Div. Co. Trin.* 34 *Eliz.*; *Recov. R. East.* 35 *Eliz.* rot. 42.

⁴² *Chan. Inq. p.m. (Ser. 2)*, cccxviii, 165.

⁴³ *G.E.C. loc. cit.*

⁴⁴ *Chan. Inq. p.m. (Ser. 2)*, cccclxxxi, 60; *Recov. R. Hil.* 20 *Jas. I*, rot. 74.

⁴⁵ *G.E.C. Peerage*, ii, 259; *Cal. S. P. Dom.* 1658-9, pp. 237, 238.

⁴⁶ *Add. MS.* 5497, fol. 143.

⁴⁷ *Dict. Nat. Biog.*

⁴⁸ *Cal. Com. for Comp.* 146, 147; *Cal. S. P. Dom.* 1658-9, pp. 237, 238; Feet of F. Div. Co. Mich. 10 *Jas. I*; cf. *ibid.* East. 8 *Jas. I*.

⁴⁹ Chauncy, op. cit. 96. In 1658 a court was held by James Earl of Northampton and Hon. Francis Compton (Court Bk. in possession of Messrs. Crossman and Prichard). Chauncy dates the conveyance to Lucy and Atkins at 'about 1657.' Later a connexion is found between the Compton and Lucy families, when Mary Lucy, daughter and heir of Sir Berkeley Lucy, married the Hon. Charles Compton (*G.E.C. Baronetage*, i, 114).

⁵⁰ *G.E.C. Baronetage*, i, 113.

⁵¹ Feet of F. Herts. Hil. 22 & 23 *Chas. II*.

⁵² Chauncy, op. cit. 96; cf. Feet of F. Herts. Trin. 33 *Chas. II*; *Duchy of Lanc. Misc. Bks.* lxxii, fol. 59.

⁵³ Chauncy, loc. cit. Sir Thomas Byde held a court in 1682.

⁵⁴ Clutterbuck, op. cit. iii, 382; Feet of F. Herts. Hil. 12 *Anne*.

⁵⁵ Clutterbuck, loc. cit.

⁵⁶ Feet of F. Div. Co. East. 32 *Geo. II*.

⁵⁷ Clutterbuck, loc. cit.

⁵⁸ Inform. from Messrs. Crossman and Prichard; cf. *Recov. R. Trin.* 35 *Geo. III*, rot. 354.

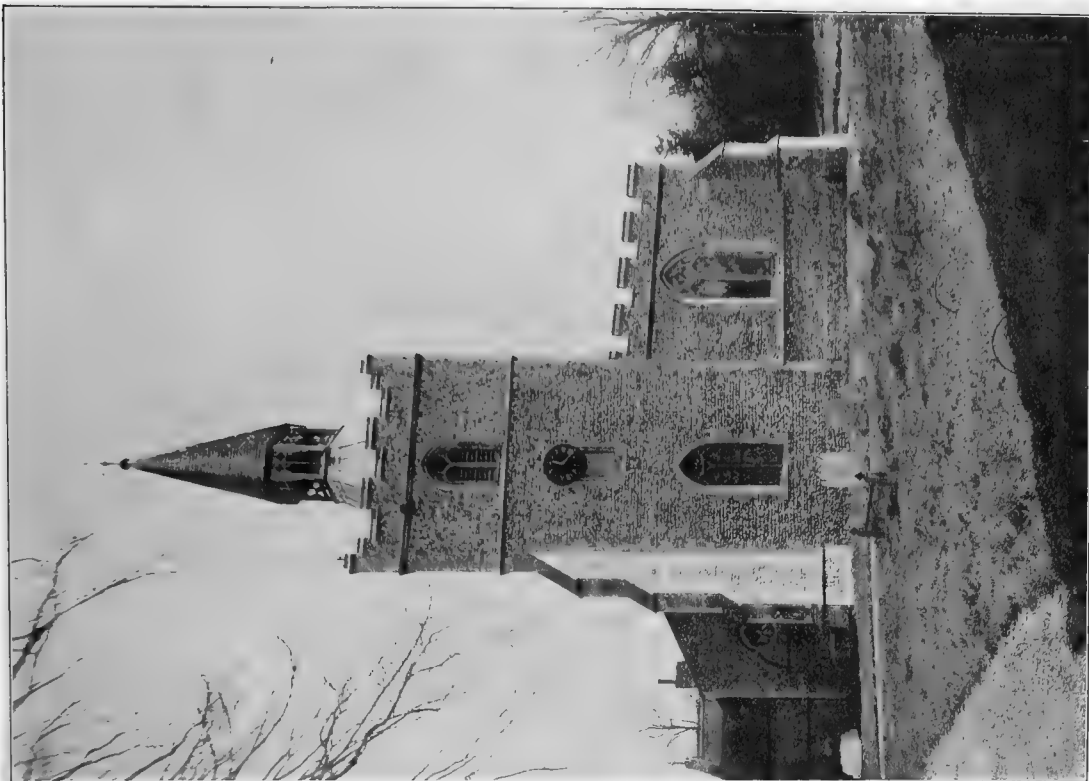

BARLEY CHURCH FROM THE WEST



BARLEY : THE BIG HOUSE, STAIRCASE WING

The Abbots of Colchester and their tenants at Barley were free of danegeld, murder and hidage under a charter of Henry II.⁵⁹ About 1275 jurors returned that the abbot had withdrawn his men from the sheriff's tourn for twelve years past.⁶⁰ The abbot laid claim to gallows and assize of bread and ale.⁶¹

The manor of *GREENBURY* was formerly in the possession of the Prior and canons of Anglesey, co. Camb.⁶² It is evidently identical with land granted to the priory by 'Henry de Stikewand.' The service from this land was that of one-half and one-sixth of a knight's fee, and was due in the early part of the 13th century to Ralph son of Fulk de Broadfield.⁶³ Thus it is clear that this manor originated in a considerable part of the 4 hides and 10 acres of land held of Harduin de Scales in 1086 by Ralph's ancestor⁶⁴ Theobald.⁶⁵ Before the Conquest Theobald's holding had been in the possession of five sokemen; three of these were Earl Algar's men, one was the man of Earl Gyrrh, brother of Earl Harold, and one was the man of Harold himself.⁶⁶ Theobald's great-grandson Fulk⁶⁷ gave a life interest in a half and a sixth of a knight's fee in Barley to Alan son of Theobald.⁶⁸ Possibly, therefore, Henry de Stikewand succeeded Alan as immediate tenant of the manor and gave it to Anglesey Priory at some time subsequent to 1222, in which year Alan was still living.⁶⁹ Ralph de Broadfield afterwards freed the priory from all obligation to do knight's service in consideration of 100s.⁷⁰ At about the same time Alan de Barley confirmed to the priory certain other land in Barley which had been given to the canons by his mother Agnes.⁷¹ In 1291 the rents of the priory in Barley were assessed at £4 13s. 4d.⁷² In the absence of evidence it is not clear whether the prior kept the demesne lands in hand, but the court was certainly held in his name in 1325.⁷³

Anglesey Priory was suppressed with the lesser monasteries in 1536.⁷⁴ In 1553 Greenbury was purchased from the Crown by Sir Robert Chester, kt.⁷⁵ He parted with it before his death in 1574,⁷⁶ probably to John Payne, yeoman, of Newsells in Barkway, who was in possession in May 1557 and then conveyed it to his son Thomas and the latter's wife Joan.⁷⁷ Thomas Payne died at Greenbury in 1583 and was succeeded by his son John.⁷⁸ In 1602 it was conveyed by John Payne and his wife Dorothy to Andrew Willett, S.T.P.,⁷⁹ a controversial divine

and author of 'Synopsis Papismi.'⁸⁰ His father had been rector of Barley from 1571 to 1598,⁸¹ and he was also rector and lived in the rectory-house.⁸² He died on 4 December 1621, having bequeathed Greenbury to his younger son John towards the payment of his debts.⁸³ The manor afterwards came by purchase into the Bowes family. In 1681 John Burscough, clerk, and his wife Hannah conveyed it to Ralph Bowes,⁸⁴ and Robert Bowes was in possession in 1700.⁸⁵ It is said to have descended to his daughter, who married into the Feltham family.⁸⁶ A Martha Feltham, spinster, possibly granddaughter of Robert Bowes, was dealing with it in 1726.⁸⁷ It was afterwards acquired by Hale Wortham and inherited by his grandson Hale Wortham of Royston. In 1844 he was succeeded by his nephew the late Biscoe Hill Wortham of Kneesworth House, co. Camb.,⁸⁸ whose trustees now hold the manor. There are only two copyholders.

The lords of Greenbury had view of frankpledge, assize of bread and ale, goods of felons and fugitives⁸⁹ and heriots.⁹⁰

The manor of *HOARES* was evidently so styled from the family of 'Hore' residing in Barley from the 13th to the 15th century.⁹¹ The name Hoares has first been found in 1539.⁹² Previously it was apparently called the manor of *BARLEY* or *BURNELLS*.⁹³ In 1294 Philip Burnell, nephew and heir of the great chancellor, died seised of 5 marks rent due from Walter the Clerk of Barley out of 200 acres there, which were said to be held partly of Ralph son of Fulk (of Broadfield) and partly of William de Graveley.⁹⁴ Obviously, then, the holding of Walter the Clerk included those 40 acres in Barley which Ralph de Graveley had held for ward at Dover Castle and had alienated shortly before 1275 to a certain William Burnell (probably the predecessor of Philip Burnell).⁹⁵ It was, therefore, probably part of the 'fee of Gravelega' included in the castle-ward barony of Adam Fitz William⁹⁶ about 1211.⁹⁷ The holding of Ralph de Graveley included more than 40 acres,⁹⁸ and was doubtless identical with the hide and a half of land in Barley which Adam was holding of Odo Bishop of Bayeux at the time of the Domesday Survey.⁹⁹ The tenant of this land before the Conquest was a man of Archbishop Stigand.¹⁰⁰

The holding of Walter the Clerk was of considerable extent; in 1291 he was assessed towards a

⁵⁹ *Cart. Mon. S. Johannis de Colecestria* (Roxburghe Club), 19, 20.

⁶⁰ *Hund. R. (Rec. Com.)*, i, 193.

⁶¹ Assize R. 323, m. 45.

⁶² Pat. 7 Edw. VI, pt. iii, m. 18; Ct. R. (Gen. Ser.), portf. 177, no. 33.

⁶³ Anct. D. (P.R.O.), B 785.

⁶⁴ *V.C.H. Herts.* iii, 210.

⁶⁵ *Ibid.* i, 339b; see also below under Hoares and Mincingbury.

⁶⁶ *V.C.H. Herts.* i, 339b.

⁶⁷ *Ibid.* iii, 210.

⁶⁸ Maitland, *Bracton's Note Bk.* ii, 127; iii, 422.

⁶⁹ *Ibid.*; a part of Theobald's holding was granted in sub-fee and became a part of Hoares Manor (q.v.).

⁷⁰ Anct. D. (P.R.O.), B 785; cf. *Feud. Aids*, ii, 430.

⁷¹ Anct. D. (P.R.O.), B 800.

⁷² *Pope Nich. Tax. (Rec. Com.)*, 14.

⁷³ Ct. R. (Gen. Ser.), portf. 177, no. 33.

The customary works are recorded in detail on this roll.

⁷⁴ See *L. and P. Hen. VIII*, x, 1238; *Mins. Accts. Hen. VIII*, no. 264.

⁷⁵ Pat. 7 Edw. VI, pt. iii, m. 18.

⁷⁶ Chan. Inq. p.m. (Ser. 2), clxx, 51.

⁷⁷ Pat. 3 & 4 Phil. and Mary, pt. vi.

⁷⁸ Chan. Inq. p.m. (Ser. 2), cciv, 114.

⁷⁹ Feet of F. Herts. Trin. 44 Eliz.

⁸⁰ *Dict. Nat. Biog.*

⁸¹ *Epis. Reg.* quoted by Clutterbuck, op. cit. iii, 385.

⁸² *Dict. Nat. Biog.* M. I. in church. Possibly Greenbury was still occupied by the Payne family (Chan. Proc. [Ser. 2], bde. 379, no. 12).

⁸³ Chan. Inq. p.m. (Ser. 2), cccevi, 51.

⁸⁴ Feet of F. Herts. Mich. 33 Chas. II.

⁸⁵ Chauncy, op. cit. 96.

⁸⁶ Clutterbuck, op. cit. iii, 383; Salmon, *Hist. of Herts.* 296.

⁸⁷ *Recov. R. Hil.* 13 Geo. I, rot. 16.

⁸⁸ Cussans, op. cit. *Edwinstree Hund.* 13. Inform. from Mr. John Balding.

⁸⁹ Pat. 7 Edw. VI, pt. iii, m. 18; Chan. Inq. p.m. (Ser. 2), cccevi, 51.

⁹⁰ Ct. R. (Gen. Ser.), portf. 177, no. 33.

⁹¹ Lay Subs. R. bde. 120, no. 2; *Cal.*

Pat. 1292-1301, p. 462; 1388-92, p. 485; *Feud. Aids*, ii, 445.

⁹² Feet of F. Herts. Mich. 31 Hen. VIII.

⁹³ De Banco R. 285, m. 257; Feet of F. Herts. 11 Edw. III, no. 185; Chan. Inq. p.m. 33 Hen. VI, no. 28, m. 10.

⁹⁴ Chan. Inq. p.m. 22 Edw. I, no. 45.

⁹⁵ *Hund. R. (Rec. Com.)*, i, 193.

⁹⁶ What appears to be another part of this fee was held by the Fitz Simons (see below), who were apparently descendants of Adam Fitz William.

⁹⁷ *Red Bk. of Exch.* (Rolls Ser.), 615.

⁹⁸ *Hund. R. (Rec. Com.)*, i, 193; cf. Assize R. 323, m. 46.

⁹⁹ *V.C.H. Herts.* i, 310.

¹⁰⁰ *Ibid.*

A HISTORY OF HERTFORDSHIRE

subsidy at the then large sum of £3 16s. 5½d.¹ He seems to have been a life tenant only.² The lands which he held of Ralph son of Fulk in 1294 were evidently a part of the 4 hides and 10 acres held of Harduin de Scales in 1086 by Ralph's ancestor Theobald.³ Walter the Clerk may be identical with the 'Walter de Barley' who with his tenants held one-quarter of a knight's fee in Barley in 1303.⁴ The overlord recorded in this case is Edward Lord Burnell, son and heir of Philip Burnell.⁵ Before his death in 1315 Edward Lord Burnell gave a life interest in a messuage and 120 acres of land in Barley to a certain Walter de Filby.⁶ Walter de Filby was still holding in 1336 when a settlement of the reversionary title to this 'manor of Barley' was made upon Maud wife of Sir John Handlo,⁷ kt., sister and heir of Lord Burnell.⁸ Consequently Sir John Handlo entered upon the manor and granted a lease for life to Walter de Thorp and his wife Avice and to William their son.⁹ Walter de Thorp of Barley was indicted with Richard le Marechal and other robbers of Royston in 1342¹⁰; but he was apparently still in possession of this holding in 1345 when Sir John Handlo settled his interest in the lands in Barley upon his son Nicholas in tail.¹¹ Nicholas succeeded his father in 1346¹² and assumed the name of Burnell.¹³

William Martin is said to have held a court for this manor about 1399,¹⁴ and to have been succeeded by Thomas Hore.¹⁵ A Thomas Hore was styled 'of Barley' in 1391, when he received exemption from sitting on juries or holding any office under the king.¹⁶ In 1428 Gilbert Hore is returned as holding the quarter-fee which had formerly been held by Walter de Thorp.¹⁷ He is said to have been son of Thomas and to have been succeeded by his son-in-law John Ayland.¹⁸ Probably both Thomas and Gilbert Hore, and possibly also John Ayland, had life interests in the manor similar to those of Walter de Thorp, his wife and son. Nicholas Burnell's son and heir Hugh Lord Burnell died without surviving male issue on 27 November 1420,¹⁹ and in 1455 the 'manor in Barley called Burnells' was in the possession of Sir William Lovel, kt.,²⁰ great-great-grandson of Maud Handlo by a former husband, John Lord Lovel,²¹ to whom it had evidently reverted in accordance with the settlement of 1336.²² William Lord Lovel died on 13 June 1455.²³ His younger son William had married Eleanor Lady Morley, and held the manor of

Walkern in her right.²⁴ At his death in 1476 he was said to hold a messuage with 200 acres of land and certain pasture and woodland in Barley as parcel of Walkern Manor.²⁵ It is obviously identical with the tenement held by Walter the Clerk in 1294,²⁶ and had probably been settled by Lord Lovel upon his younger son. It descended to Henry Lord Morley, son of William (Lovel) and Eleanor Lady Morley, and at his death passed to his sister Alice,²⁷ who married as her second husband Sir Edward Howard, second son of Thomas, afterwards Duke of Norfolk and Admiral of the Fleet.²⁸ He died without legitimate children in April 1513,²⁹ and in the following February the 'manor of Barley' together with Acton Burnell and other manors was granted to his father Thomas upon his creation as Duke of Norfolk after his victory at Flodden Field.³⁰ The duke's eldest son, Thomas third Duke of Norfolk, sold 'the manor of Barley otherwise Hoares' to Ralph Rowlatt in 1539.³¹ Rowlatt afterwards purchased Mincingbury, and was succeeded in March 1542-3 by his son Ralph Rowlatt,³² who acquired Abbotsbury. The whole estate has descended with Abbotsbury (q.v.) to Mr. A. Crossman of Cockenach, the present owner. It is said that in this manor, as at Cheshunt, the custom of Borough English prevails below a certain line called the Bank.³³

MINCINGBURY or **BARLEY CHATTERIS** Manor was acquired before the Conquest by the Benedictine nuns of Chatteris, co. Camb. In 1086 their 'manor' in Barley was held in demesne and was extended at 3½ hides.³⁴ In 1268 there were added by the gift of Ralph son of Ralph son of Fulk (of Broadfield) the advowson of Barley Church and 3 acres of land there.³⁵ The land and rents of the abbey in Barley were valued at £10 2s. 10d. in 1291.³⁶ Courts baron with view of frankpledge were held in the name of the abess in 1506,³⁷ and the courts, royalties and advowson were reserved in a thirty years' lease of the manor to John Chapman on 20 May 1531.³⁸ The abbey surrendered to the



ROWLATT. *Gules a chevron couped closed argent with three lions gules on the chevron.*

¹ Lay Subs. R. bdl. 120, no. 2.

² See below.

³ *V.C.H. Herts.* i, 339b; iii, 210; cf. the accounts of Mincingbury and Greengrass as to the early descent of this manor.

⁴ *Feud. Aids*, ii, 430; Walter de Barley may, however, be the 'Walter de Filby' mentioned below.

⁵ *Ibid.*; Chan. Inq. p.m. 22 Edw. I, 45; G.E.C. *Peerage*, ii, 82. In a return of 1346 the service due to the lord of Broadfield Manor (descendant of Theobald) is recorded, but nothing further is found concerning the overlordship of this manor beyond the fact that it was held of others than the king by diverse services (Chan. Inq. p.m. 20 Edw. III, 51; *Cal. Close*, 1346-9, p. 110). The statement made in 1477 that this land was parcel of Walkern Manor was evidently an error arising out of the recent acquisition of Walkern by the tenant of the Barley holding (Chan. Inq. p.m. 16 Edw. IV, no. 73; cf. *V.C.H. Herts.* iii, 154).

⁶ De Banco R. 274, m. 106.

⁷ Feet of F. Herts. 4 Edw. III, no. 65; De Banco R. 285, m. 257; Feet of F. Herts. 11 Edw. III, no. 185.

⁸ De Banco R. 274, m. 106.

⁹ Add. Chart. 47541.

¹⁰ *Cal. Pat.* 1340-3, p. 555.

¹¹ Add. Chart. 47541.

¹² Chan. Inq. p.m. 20 Edw. III, no. 51; *Cal. Close*, 1346-9, p. 110.

¹³ G.E.C. *Peerage*, ii, 82.

¹⁴ Chauncy, op. cit. 95.

¹⁵ *Ibid.*

¹⁶ *Cal. Pat.* 1388-92, p. 485.

¹⁷ *Feud. Aids*, ii, 445. This return tends to prove that Burnells is identical with Hoares, rather than a distinct holding, as is suggested by some authorities.

¹⁸ Chauncy, loc. cit.

¹⁹ G.E.C. *Peerage*, ii, 83.

²⁰ Chan. Inq. p.m. 33 Hen. VI, no. 28, m. 10.

²¹ G.E.C. *Peerage*, v, 164.

²² Feet of F. Herts. 11 Edw. III, no. 185.

²³ Chan. Inq. p.m. 33 Hen. VI, no. 28, m. 10.

²⁴ *V.C.H. Herts.* iii, 154.

²⁵ Chan. Inq. p.m. 16 Edw. IV, no. 73.

²⁶ This was extended at 200 acres (Chan. Inq. p.m. 22 Edw. I, no. 45).

²⁷ *Cal. Inq. p.m. Hen. VII*, i, 213.

²⁸ G.E.C. *Peerage*, v, 372.

²⁹ Nicolas, *Test. Vetusta*, 533.

³⁰ *L. and P. Hen. VIII*, i, 4694.

³¹ Feet of F. Herts. Mich. 31 Hen. VIII; Recov. R. Trin. 31 Hen. VIII, rot. 147.

³² Chan. Inq. p.m. (Ser. 2), lxviii, 40.

³³ Clutterbuck, op. cit. iii, 382. In Mincingbury also the custom of Borough English obtains in certain tenements (Ct. R. penes Messrs. Crossman and Prichard).

³⁴ *V.C.H. Herts.* i, 316b.

³⁵ Feet of F. Herts. 52 Hen. III, no. 594; Cott. MS. Jul. A i, fol. 140.

³⁶ *Pope Nich. Tax.* (Rec. Com.), 15.

³⁷ Ct. R. (Gen. Ser.), portf. 177, no. 1.

³⁸ *Mins. Accts. Hen. VIII*, no. 266.

Crown on 3 September 1538³⁹ and in May 1540 its interest in Mincingbury Manor was acquired by Ralph Rowlatt the elder,⁴⁰ who had recently purchased the manor of Hoares. It was inherited by his son Ralph,⁴¹ and has since descended with the Abbotsbury estate (q.v.).

A part of the fee of Graveley (see above) was presumably the land held of Hugh Fitz Simon (apparently descendant of Adam Fitz William)⁴² by Walter de Monchensey in 1346.⁴³ Here, as in Radwell, in Odsey Hundred, the lands of the Fitz Simons passed before 1428 to John Muslee.⁴⁴ The subsequent history of this tenement is unknown.

Among the tenants in Barley in 1086 was William de Odburgville. He held in demesne $4\frac{1}{2}$ hides which had belonged to Lewin, one of King Edward's thegns.⁴⁵ The history of this holding is obscure. Possibly it formed part of the manor of 'Rokey' in Barkway, since William's son Peter gave other lands in Suffolk to 'William de la Rokele,'⁴⁶ and the manor of Rokey extends into Barley.

Twenty acres held by Ansfrid of Geoffrey de Bech in 1086, and formerly held by Algar, one of Wigar's men,⁴⁷ probably amalgamated with Ansfrid's holding at Cockenach in Barkway (q.v.).

The church of *ST. MARGARET CHURCH* consists of chancel 34 ft. 6 in. by 21 ft., nave 50 ft. by 20 ft., modern north aisle 9 ft. 6 in. wide, south aisle 15 ft. wide and west tower 12 ft. 6 in. square, all internal dimensions. The walls are built of flint rubble with stone dressings; portions of the tower are faced with flint and pebbles laid in herring-bone pattern.⁴⁸

The west tower is the earliest part of the building, the two lower stages dating from the early part of the 12th century. The nave was enlarged, or perhaps rebuilt, late in the 13th century, when the south aisle was added; the south aisle was widened about the middle of the 14th century. The present bell-chamber was added to the tower in the 15th century, and early in the 16th century new windows were inserted in the south wall. In 1872 the chancel was pulled down and rebuilt⁴⁹ a bay further east, thus lengthening the nave about 11 ft.; a portion of the south aisle was lengthened eastwards; a north aisle was built and the nave widened by adding 2 ft. to the north side; a north porch was erected and a timber spire added to the tower.

The chancel with the vestry and organ chamber on the south side are modern. The nave, which originally measured about 39 ft. by 18 ft., has north and south arcades of four bays. The north arcade, together with the chancel arch, is modern. The easternmost bay of the south arcade is also modern, but the other three are of late 13th-century date, with arches of two orders, a splay and a hollow next the nave, and plain splays next the aisle; there are no labels. The piers are octagonal with moulded capitals and bases.

The north aisle is modern. The south aisle extends to the west face of the tower. This extension probably took place when the aisle was widened about 1340. The west end of the aisle is used as a quire vestry, and a modern wall separates it from the rest of the aisle. In the south wall are three early 16th-century windows. The central one is a little later in date than the others and has three cinquefoiled lights under a four-centred arch; the other two are each of three cinquefoiled lights with traceried head under a four-centred arch. These windows have been restored. In the west wall is a two-light window of about 1340, with flowing tracery, which has been repaired. The south door, which is blocked, has an arch of two continuous orders, the inner wave moulded, of about 1340. There is a modern door to the quire vestry in the south wall. In the south wall, near the east end of the aisle, is a piscina of about 1340, which has had continuously moulded arch and jambs, but the upper part of the arch was destroyed to make room for the 16th-century window above. The roofs of nave and aisle are modern, but under the roof truss in the quire vestry is a carved grotesque corbel of stone. The wall of the south aisle is embattled.

The west tower is of three stages with embattled parapet and modern timber spire. The early 12th-century tower arch is 8 ft. wide and has a plain round arch of one square order; the jambs are square and the impost is splayed. On the south side, opening into the quire vestry, is a pointed arch with splayed edges of 14th-century date; above it is a small round-headed opening without any rebate for glass. The west window of two lights with traceried head is modern. The wooden ladder to the bell-chamber is probably mediaeval; the side timbers measure $9\frac{1}{2}$ in. by $4\frac{1}{2}$ in. with splayed arrises and are 14 in. apart, the rungs are 3 in. by $1\frac{3}{4}$ in. The ladder is very similar to that in Barkway Church. The second stage of the tower retains the original 12th-century belfry windows, which have round beaded arches; they have been restored, and on the west face a clock dial hides part of the arch. In the third stage, which was added in the 15th century, are the present belfry windows, each of two cinquefoiled lights with traceried head.

The font is modern; the seating is also modern.

On the nave floor near the pulpit is a brass with the figure of a man and inscription to Andrew Willett, 1621, rector. On the south wall of the organ chamber is a palimpsest brass with inscription to Robert Bryckett, 1563; the other side has part of a 15th-century inscription. On the same wall is a brass inscription to Anne Brownrigg, 1630, wife of Dr. Brownrigg, rector. In the central window of the south aisle are fragments of old glass, probably of different dates, with figures and the date 1536. These are probably portions of the glass put up in memory of William Warham, Archbishop of Canter-

³⁹ Dugdale, *Mon.* ii, 616.

⁴⁰ *L. and P. Hen.* VIII, xv, g. 733 (42).

⁴¹ *Chan. Inq.* p.m. (Ser. 2), lxviii, 40.

⁴² See *V.C.H. Herts.* iii, 245, where the ancestor of the Fitz Simon family appears as Simon Fitz Adam.

⁴³ *Feud. Aids*, ii, 436.

⁴⁴ *Ibid.* 448.

⁴⁵ *V.C.H. Herts.* i, 328a.

⁴⁶ *Plac. de Quo Warr.* (Rec. Com.), 728.

⁴⁷ *V.C.H. Herts.* i, 333b.

⁴⁸ By will dated 1501 Thomas Chapman desired to be buried in the churchyard of Barley. 'I bequethe toward the peynting of Our Lady in the same church xs.' He left bequests to the light of the torches, to the light of the sepulchre in the said church, to the gild of St. Katherine and to the repair of the steeple. To the leading of the steeple of Barley he left

40s., under condition that the same steeple should be leaded within three years immediately after his decease (P.C.C. 5 Blamyr). In 1516 William Robinson, parson of the church, left to the church of Barley an antiphoner, grayle and mass book in print (*ibid.* 18 Holder).

⁴⁹ The work was carried out under the supervision of William Butterfield as architect.

A HISTORY OF HERTFORDSHIRE

bury and rector of Barley. In the west window of the tower are some late 14th-century fragments, and in the rectory is portion of a Crucifixion of the same period, which has been refixed in the church.

Some remains of open tracery work of a 15th-century screen have been fixed on the north wall of the chancel. The pulpit is of oak, richly carved and panelled, and with a canopy; it is dated 1626. In the quire vestry is a large mediaeval chest, 7 ft. in length, bound with iron.

There are five bells, all recast by Thomas Mears & Son, 1807.

The communion plate includes an embossed cup and cover, dated 1612. It bears an inscription indicating that additions had been made to it, probably in 1612, but the embossed pattern is of earlier date, probably about 1550; the cover has lost its canopy. There is also a paten of 1618.

The registers previous to 1812 are as follows: (i) baptisms and marriages 1559 to 1746, burials 1559 to 1743; (ii) baptisms and burials 1746 to 1776, marriages 1746 to 1753; (iii) baptisms and burials 1777 to 1812; (iv) marriages 1754 to 1812.

A priest was mentioned in 1086 *ADVOUWSON* among the tenants on the land of Harduin de Scales.⁵⁰ The church was evidently in the gift of Theobald, tenant under Harduin, as his descendant Ralph son of Ralph son of Fulk (of Broadfield) gave the advowson to Chatteris Abbey in 1268.⁵¹ The benefice was vacant in 1281, and Ralph then confirmed his gift to the abbey.⁵² The church remained in the gift of successive abbesses until the surrender of the monastery in September 1538.⁵³ In the following December the advowson was given in exchange to the Bishop of Ely.⁵⁴ The living remained in the gift of the Bishops of Ely⁵⁵ until 1852, when it was transferred to the Bishops of Oxford.⁵⁶ In September 1854 it was exchanged with the Crown.⁵⁷

Among the notable incumbents were Thomas Willett and his son Andrew⁵⁸; Ralph Brownrigg, afterwards Bishop of Exeter; Herbert Thorndike, from whom the living was sequestered⁵⁹; Nathaniel Ball, his successor in 1657; Thomas Milles, afterwards Bishop of Waterford; Edmund Castle, Dean of Hereford, who was buried at Barley in 1744; William Warham and Thomas Herring, afterwards Archbishops of Canterbury; and the theologians Mark Frank and Thomas Rutherford.⁶⁰

Since the time of Nathaniel Ball there has been a considerable Dissenting congregation in the parish.⁶¹ The endowment of the present Congregational

chapel, to the west of the Cambridge Road, dates from about 1846.⁶²

In 1626 Thomas Chapman, by *CHARITIES* his will, left £1 a year for bringing up young scholars of the name of Chapman. The legacy is now represented by £40 consols with the official trustees.

Stephen Peirce, M.D.—as stated in the Parliamentary returns of 1786—by his will gave £3 a year for the use of the free school. This sum is received from the bursar of Caius College.

The Poor's Land charity, comprised in an indenture of 1704, and the charity of Mrs. Brytchett, founded by deed 1638, now consist of an allotment of 18 a. 1 r. 30 p., known as Cobdell Field, given under the inclosure award in exchange for several lands belonging to the poor. The land produces £10 16s. yearly, of which £1 a year forms the endowment of the Poor's Land Educational Foundation.

In 1621 Ralph Dobson by his will gave £1 yearly to the poor, issuing out of a house in Maiden Lane, London.

The Parliamentary returns of 1786 likewise include the five charities next mentioned, namely:—

Isaac Cowper's charity, being a yearly sum of 13s. 4d. issuing out of land known as Bull Croft;

Lettice Martin's charity, trust fund, £52 17s. consols with the official trustees, arising from the redemption of an annuity of £1 6s.;

Andrew Willett's charity, consisting of a house and 2 r., situated near the church, producing £3 yearly;

Blyth's charity, being an annuity of 4s., payable out of a house and land in Barley; and

Joseph Wortham's charity, will, 1689, being an annuity of 10s. issuing out of a house in Royston.

An unknown donor also gave a sum of 10s. to the poor.

The parish is also in possession of a tenement of 3 r. of land next the Swan Inn, producing about £5 a year, of which 17s. a year is given to the poor and the balance of the net income for church purposes.

The Town House (formerly the workhouse and afterwards used as the free school), comprised in trust deed of 1825, is used partly for meetings of the parish council, &c., whilst the lower part, formerly used as almshouses, is now used as store-rooms for the tenants of three cottages adjoining. The origin of this custom is unknown. The cottages produce £9 3s. yearly.

In 1910 the sum of £5 was applied for educational purposes, £3 for church purposes, 10s. in bread (Wortham's charity), and the balance of the income in the distribution of half-crowns to the poor.

BUCKLAND

Boclande (x-xiii cent.); Bochelande (xi cent.); Bokeland (xiii-xiv cent.).

The village of Buckland consists of a single street on the southern slope of the Hertfordshire chalk hills. It is built on either side of the main road from Buntingford to Royston. On the east of the street is

Buckland House and behind it, near the by-road leading to Barkway, lie the church and rectory. There are traces of a circular moat to the south-west of the church. In the same neighbourhood is the school, founded about the middle of the 19th century.

⁵⁰ *V.C.H. Herts.* i, 339b.

⁵¹ Feet of F. Herts. 52 Hen. III, no. 594; Cott. MS. Jul. A i, fol. 140; see Mincingbury above.

⁵² Cott. MS. Jul. A i, fol. 141 d.

⁵³ Mins. Accta. Hen. VIII, no. 266.

⁵⁴ *L. and P. Hen. VIII*, xiii (2), 904; g. 1182 (19).

⁵⁵ *Inst. Bks.* (P.R.O.).

⁵⁶ *Orders in Council ratifying schemes of Eccl. Com.* viii, 193.

⁵⁷ *Ibid.* ix, 408.

⁵⁸ See under Greenbury above.

⁵⁹ *Dict. Nat. Biog.*; *Hist. MSS. Com. Rep.* vii, App. 101b, 108b.

⁶⁰ *Dict. Nat. Biog.*

⁶¹ *Sess. R.* (Herts. Co. Rec.), i, 256, 279, 363; ii, 49; Urwick, *Nonconformity in Herts.* 739.

⁶² *Close*, 1846, pt. li, m. 6.



BARLEY : THE FOX AND HOUNDS INN



BUCKLAND CHURCH FROM THE SOUTH-EAST

The road descends in a southerly direction into the valley of the Rib, which it crosses at the hamlet of Chipping, sometimes styled 'New' Chipping or 'New Cheping,' probably on account of the market established there in 1252.¹ Beyond Chipping Bridge is the manor-house of Pope's Hall. A Congregational chapel at the head of the hamlet was built about 1844.²

The parish is small, including only 1,629 acres. The boundary between Therfield and Buckland passes through the village street. The houses on the west side of the street are in Therfield for civil purposes, but have been in the ecclesiastical parish of Buckland since 1857.³ The greater part of the parish is arable land. There are about 220 acres of grass, and a little woodland lies on the borders of Wyddial.⁴ At Burhill Wood near Pope's Hall is a dry stirrup-shaped moat entered from the north.

The village probably owed what importance it had to its position on the high road. The lord of Buckland had a grant of a weekly market on Tuesdays and an annual three days' fair beginning on the vigil of the feast of St. Simon and St. Jude.⁵ This grant was made in 1258. In 1252 the lord of Pope's Hall had had a grant of a weekly market on Fridays and a three days' fair to be held yearly beginning on the vigil of the feast of St. Gregory.⁶ The tolls of the market at Pope's Hall were farmed at 16s. yearly in 1322,⁷ and the market was held at 'the New Cheping.' Elizabeth de Burgh replaced this market by one at her manor of Buntingford in 1360.⁸ The fair was also abolished,⁹ but appears to have been renewed, since two fairs, one held at Buckland, the other at Chipping, were abolished in 1883.¹⁰ Neither of the markets is now in existence.

In the time of Edward the Confessor *MANORS BUCKLAND* was held by Sait, a man of Earl Lewin's. After the Conquest it was held by Osbern under Odo Bishop of Bayeux, brother of William I.¹¹ The lands held of the bishop by Osbern seem generally to have been acquired by the Ports.¹² Knight's service was subsequently due from the lord of Buckland to the lord of Tonge Castle, co. Kent,¹³ which had been held of Odo by Hugh de Port in 1086.¹⁴

After the bishop had forfeited his English lands in 1088, the overlordship of Buckland apparently remained with the lords of Tonge Castle, Hugh de Port and his descendants the St. Johns.¹⁵ A fee in Buckland was held of Hugh's great-grandson Adam

de Port.¹⁶ Later Tonge Castle, apparently including the overlordship of Buckland, was held under Adam's direct descendant by Ralph Fitz Bernard, who died about 1306.¹⁷ He was ultimately succeeded as overlord of Buckland by his grandson Bartholomew Lord Badlesmere.¹⁸

During the 13th century the immediate tenants of Buckland took their name from the manor. Philip de Buckland had a grant of free warren in all his Hertfordshire lands and of market and fair at Buckland in 1258.¹⁹ He was probably the Philip de Buckland who was the king's marshal and had accompanied Prince Edward in his Welsh expedition in the year previous to this grant.²⁰ Of his predecessors little is known.²¹ Possibly Henry de Buckland, who was attorney of William de St. John, the overlord of this manor in 1228, and brought a plea concerning the wardship of certain lands in Hertfordshire in 1233,²² was lord of Buckland in this county.²³ Henry son of Henry de Buckland held land here in 1249.²⁴ Contemporary with Philip de Buckland was a certain Stephen, who was clerk to Bertram de Crioll, lord of the manor of Pope's Hall in this parish.²⁵ The lord of Buckland in 1303 was Henry de Buckland.²⁶

In 1313 settlement was made on Henry and his wife Alice in survivorship, with successive remainders to Henry's sons Reginald and Richard and his daughter Eleanor in tail.²⁷ Alice survived her husband and surrendered her life interest in the manor to the overlord Bartholomew Lord Badlesmere for a yearly rent of £20.²⁸ Reginald having died childless, Richard his brother was heir under the settlement of 1313,²⁹ and as such remitted to Badlesmere all his right in the manor.³⁰ The latter was implicated in the revolt of 1322, surrendered to the king after Boroughbridge, and was hanged at Canterbury.³¹ Buckland was seised by the king with his other lands,³² whereupon Richard de Buckland petitioned for its restoration, maintaining that Badlesmere's interest had lapsed with the death of Alice widow of Henry de Buckland.³³ In April 1323 order was given for the delivery of Buckland to the petitioner³⁴; but his deed of release to Badlesmere was subsequently discovered among the latter's muniments,³⁵ which had been taken to the Tower.³⁶ In 1327 Margaret Lady Badlesmere, widow of Bartholomew, whose action in excluding the queen from Leeds Castle had been the immediate cause of the disturbances of 1322,³⁷ claimed that Buckland had been settled upon her jointly with her husband.³⁸ She had restoration of all her lands in 1327,³⁹ and

¹ *Abbrev. Rot. Orig.* (Rec. Com.), ii, 293; *Cal. Chart. R.* 1226-57, p. 404.

² *Sess. R.* (Herts. Co. Rec.), ii, 425.

³ Order in Council, 16 July 1857.

⁴ Statistics from Bd. of Agric. (1905).

⁵ *Cal. Chart. R.* 1257-1300, p. 12.

⁶ *Ibid.* 1226-57, p. 404.

⁷ *Mins. Accts.* bde. 1147, no. 9, m. 7.

⁸ *Abbrev. Rot. Orig.* (Rec. Com.), ii, 293.

⁹ *Ibid.*

¹⁰ *Lond. Gaz.* 2 Jan. 1883, p. 33.

¹¹ *V.C.H. Herts.* i, 310b.

¹² See *V.C.H. Herts.* iii, 222. This was also the case with his Kentish lands.

¹³ *Cal. Inq. p.m.* 1-10 *Edw. III*, 91.

¹⁴ *Dom. Bk. Fac. Kent*, 17.

¹⁵ *Cal. Inq. p.m.* 1-10 *Edw. III*, 91; *Chan. Inq. p.m.* 12 *Edw. III* (2nd nos.), no. 54a. For an account of the Port family see *V.C.H. Hants*, iv, 115-16.

¹⁶ *Testa de Nevill* (Rec. Com.), 270.

¹⁷ *Chan. Inq. p.m.* 34 *Edw. I*, no. 53.

¹⁸ See below; cf. Hasted, *Hist. of Kent*, ii, 602.

¹⁹ *Cal. Chart. R.* 1257-1300, p. 12.

²⁰ *Cal. Pat.* 1247-58, pp. 578, 586; cf. p. 635 and *ibid.* 1258-66, p. 54.

²¹ Possibly Gregory of Buckland, party to a plea concerning 4 acres in Buckland, co. Herts., in 1199, was one of them (*Rot. Cur. Reg.* [Rec. Com.], ii, 69).

²² *Cal. Close*, 1227-31, p. 58; Maitland, *Bracton's Note Bk.* ii, 621.

²³ Chauncy (*Hist. Antiq. of Herts.*) has confused this family with others of the same name, and has been followed in this by more recent historians. It is not known whether Geoffrey de Buckland, Dean of St. Martin's and justice itinerant in Hertfordshire (*Cal. Pat.* 1216-25, *passim*), came of the family now under

consideration. The Nicholas de Buckland who built the church in 1348 (see below) was probably of this family.

²⁴ *Cur. Reg. R.* 135, m. 10.

²⁵ *Excerpta e Rot. Fin.* (Rec. Com.), ii, 232.

²⁶ *Feud. Aids*, ii, 431.

²⁷ Feet of F. Herts. 7 *Edw. II*, no. 132.

²⁸ *Cal. Close*, 1318-23, p. 635.

²⁹ *Ibid.*

³⁰ *Ibid.* 1323-7, p. 53.

³¹ *G.E.C. Complete Peerage*, i, 215.

³² *Parl. R.* i, 405b.

³³ *Ibid.*

³⁴ *Cal. Close*, 1318-23, p. 635.

³⁵ *Ibid.* 1323-7, pp. 53, 111.

³⁶ *Parl. R.* ii, 430a.

³⁷ *G.E.C. loc. cit.*

³⁸ *Parl. R.* ii, 430a; cf. *Cal. Inq. p.m.* 1-10 *Edw. III*, 91.

³⁹ *Parl. R.* ii, 422a.

A HISTORY OF HERTFORDSHIRE

doubtless recovered Buckland Manor.⁴⁰ Her son Giles was seized of it at his death in 1338.⁴¹ It was among the manors assigned in dower to his widow Elizabeth,⁴² and the reversion contingent upon her death was included in the purparty of Margery wife

granted Buckland for life to Jaques Haulte, esquire, one of the 'kervers' of the queen.⁴⁰ John Horne, otherwise Littlebury, son of the Thomas Horne mentioned above, took this occasion to petition for the restoration of the manor to his family under the settlement of 1313.⁴⁷ The grant to Jaques Haulte was cancelled in December 1468,⁴⁸ but John Horne apparently failed to make good his claim. Edmund son of the last-mentioned Lord Roos obtained the reversal of his father's attainder⁴⁹ and recovered Buckland Manor.⁶⁰ Since he was not 'of sufficient discretion to govern himself,' the custody of his lands was granted for life to Sir Thomas Lovell, kt., his brother-in-law.⁶¹ Sir Thomas died 25 May 1524, and Buckland then passed to Thomas (Manners) Lord Roos, great-nephew and heir of Edmund Lord Roos.⁶² He was created Earl of Rutland on 18 June 1525,⁶³ and in 1529 sold this manor to Edward Watson.⁶⁴ The latter died in the following year and was succeeded by his son Henry.⁶⁵ Edward Watson, probably the heir of this Henry,⁶⁶ with his wife Dorothy sold Buckland Manor to James Altham, citizen and clothworker of London, in 1552.⁶⁷ Altham died at Latton, co. Essex, 28 February 1582-3.⁶⁸ In accordance with a settlement of 1577 his widow Mary, formerly wife of Sir Andrew Judd, kt., held Buckland for her life, and it then passed to his second son Edward Altham.⁶⁹ The latter died in 1605; his widow Elizabeth survived⁷⁰ and in 1607 joined in a settlement of the manor on her son Sir James Altham, kt., upon his marriage with Elizabeth Barrington.⁷¹ Sir James bequeathed it to his brother Edward, failing his own issue male. He died in 1610, leaving an only daughter, an infant named Joan,⁷² and his brother Sir Edward Altham, kt., of Mark Hall in Latton, succeeded.⁷³ Sir Edward died at Mark Hall, 28 May 1632.⁷⁴ His widow Joan had a life interest in the manor.⁷⁵ Their son and heir James was fined as a Royalist in 1645,⁷⁶ and was created a knight of the Bath at the coronation of Charles II.⁷⁷ He gave Buckland in marriage with his daughter Mary to Sir John Tufton, bart.,⁷⁸ who sold it to James Hoste.⁷⁹ He sold it about 1669 to Samuel Mellish of Doncaster,⁸⁰ who was still in possession in 1700.⁸¹ From him⁸² it was purchased

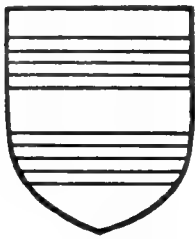

BADLESMERE. Argent
a fesse between double
cotises gules.

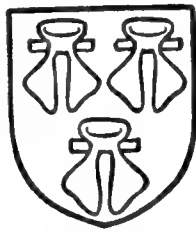

Roos. Gules three
water bougets argent.

of William de Roos of Hamelak, sister and co-heir of Giles de Badlesmere.⁴³

From the time of Badlesmere's acquisition of Buckland the service due at the castle of Tonge appears to have lapsed. In all subsequent records the manor is said to be held of the king in chief.⁴⁴

Buckland remained with the Lords Roos for nearly two centuries. It was entailed on the heirs of Thomas Lord Roos,⁴⁵ second son and ultimate heir of William and Margery,⁴⁶ by his wife Beatrice, who married as her second husband Sir Richard de Burley, kt.⁴⁷ She died in the spring of 1415 and was succeeded by her grandson John son of William Lord Roos.⁴⁸ Upon his death on Easter Eve 1421⁴⁹ the manor was taken into the king's hands during the minority of his brother Thomas, who was his heir.⁵⁰ A certain Thomas Horne, evidently the grandson of Eleanor sister of Richard de Buckland,⁵¹ was then farming the manor.⁵² Thomas Lord Roos died seized of it 18 August 1430, leaving an infant son Thomas.⁵³ Eleanor, widow of Thomas Lord Roos the father and afterwards wife of Edmund (Beaufort) Duke of Somerset, held it in dower until her death 6 March 1466-7.⁵⁴ The estates of her son Thomas Lord Roos had been forfeited upon his attainder as a Lancastrian in 1461,⁵⁵ and in April 1468 the king

⁴⁰ See *Cal. Inq. p.m.* 1-10 Edw. III, 91.

⁴¹ *Chan. Inq. p.m.* 12 Edw. III (2nd nos.), no. 544.

⁴² *Cal. Close*, 1337-9, p. 498.

⁴³ *Ibid.* 1341-3, p. 146.

⁴⁴ *Chan. Inq. p.m.* 7 Ric. II, 68; (Ser. 2), li, 13; *Cal. Pat.* 1385-9, p. 57. Tonge had been assigned to Elizabeth Countess of Northampton, another sister of Giles de Badlesmere (Hasted, *Hist. of Kent*, ii, 603).

⁴⁵ *Chan. Inq. p.m.* 7 Ric. II, no. 68.

⁴⁶ G.E.C. *Complete Peerage*, vi, 401; but it should be noted that the same work names his widow Margaret and not Beatrice (see text).

⁴⁷ *Cal. Pat.* 1385-9, pp. 57, 149; Close, 10 Ric. II, pt. i, m. 23 d.; Feet of F. Div. Co. 10 Ric. II.

⁴⁸ *Chan. Inq. p.m.* 3 Hen. V, no. 44; cf. G.E.C. loc. cit.

⁴⁹ *Chan. Inq. p.m.* 9 Hen. V, no. 58.

⁵⁰ *Mina. Accts.* (Gen. Ser.), bdle. 1121, no. 12, 13, 17.

⁵¹ *Chan. Inq. p.m.* 8 Edw. IV, no. 60.

⁵² *Mina. Accts.* (Gen. Ser.), bdle. 1121, no. 12.

⁵³ *Chan. Inq. p.m.* 9 Hen. VI, no. 48.

⁵⁴ *Ibid.* 7 Edw. IV, no. 20.

⁵⁵ *Parl. R.* v, 477b.

⁵⁶ *Cal. Pat.* 1467-77, p. 86.

⁵⁷ *Chan. Inq. p.m.* 8 Edw. IV, no. 60; *Cal. Pat.* 1467-77, p. 100. It is noteworthy that a John Horne was among the jurors who had returned Buckland among the lands of John Lord Roos in 1421 (*Chan. Inq. p.m.* 9 Hen. V, no. 58).

⁵⁸ *Cal. Pat.* 1467-77, p. 86.

⁵⁹ G.E.C. *Complete Peerage*, vi, 403.

⁶⁰ De Banco R. 964, m. 431.

⁶¹ *Ibid.*; cf. G.E.C. loc. cit. Lovell's interest was for life only. It was probably in error that the manor of Buckland was included in the grant to Edward Downing and John Walker in 1579 of lands which had belonged to Sir Francis Lovell (*Pat. 21 Eliz. pt. vi, m. 1*).

⁶² Ct. of Wards Misc. Bks. dlxxviii, fol. 126 d.

⁶³ G.E.C. loc. cit.

⁶⁴ *L. and P. Hen. VIII*, iv, 5624 (20); Feet of F. Herts. Trin. 21 Hen. VIII; *Recov. R. Trin.* 21 Hen. VIII, rot. 336.

⁶⁵ *Chan. Inq. p.m.* (Ser. 2), li, 13.

⁶⁶ Feet of F. Herts. Mich. 6 Edw. VI.

⁶⁷ *Ibid.* Apparently he obtained further assurance of his title from Kenelm

Watson in 1556 (*Recov. R. Hil.* 3 & 4 Phil. and Mary, rot. 546).

⁶⁸ *Chan. Inq. p.m.* (Ser. 2), ccii, 176; cf. *Visit. of Essex* (Harl. Soc.), 538.

⁶⁹ *Chan. Inq. p.m.* (Ser. 2), ccii, 176.

⁷⁰ *Ibid.* ccxiv, 74.

⁷¹ *Ibid.* cccix, 201; *Recov. R. East.* 5 Jas. I, rot. 27.

⁷² *Chan. Inq. p.m.* (Ser. 2), cccix, 201.

⁷³ *Ibid.* cccclxv, 63. A settlement was made on him by his mother Elizabeth in 1612 (*ibid.*).

⁷⁴ *Ibid.* (Ser. 2), cccclxv, 63.

⁷⁵ *Ibid.*; cf. Feet of F. Div. Co. East. 12 Chas. I.

⁷⁶ *Cal. Com. for Comp.* 879; cf. *Recov. R. East.* 12 Chas. I, rot. 163; *Hil.* 21 Chas. I, rot. 31.

⁷⁷ Shaw, *Knights of Engl.* i, 166.

⁷⁸ Chauncy, op. cit. 114; cf. G.E.C. *Baronetage*, ii, 151.

⁷⁹ Chauncy, loc. cit.; cf. Feet of F. Herts. Trin. 17 Chas. II; *Recov. R. Trin.* 17 Chas. II, rot. 116.

⁸⁰ Feet of F. Herts. Mich. 21 Chas. II.

⁸¹ Chauncy, loc. cit.

⁸² Salmon, *Hist. of Herts.* 304. Possibly the sale was made by the heir of Samuel Mellish (*Recov. R. Hil.* 7 Anne, rot. 17).

by Ralph Freeman of Hamells in Braughing. It descended with that estate (q.v.) to Philip (Yorke) second Earl of Hardwicke. He was succeeded at Buckland by his nephew Philip, the third earl,⁸³ whose daughter Anne Countess of Mexborough was his heir.⁸⁴ The estate is at present in the possession of her grandson the Hon. John Henry Savile of Arden Hall, co. York.

The reputed manor of HORNE evidently originated in a messuage or mansion-house called 'The Horne,' which was held as of Buckland Manor.⁸⁵ Possibly it belonged to the Horne family during the 14th and 15th centuries,⁸⁶ as it was in the possession of John Shuckburgh about 1519,⁸⁷ who was heir of Thomas son of John Shuckburgh who married Clemency daughter of John Horne, great-grandson of Eleanor de Buckland.⁸⁸ John Shuckburgh sold it to Robert Dormer, gentleman, about 1519,⁸⁹ and in February 1527-8 he alienated to Edward Watson,⁹⁰ who purchased the main manor of Buckland shortly afterwards.⁹¹ The two estates were thus amalgamated, and by 1700 the manor of Buckland was sometimes known as the 'manor of Horne.'⁹²

* The manor of POPE'S HALL (Popleshall, Popeshal or Poppeshal, xiii cent.; Little Popeleshale,⁹³ xiv cent.; Popsale, xv cent.; Popesall or Popeshey, xvii cent.) was probably included in the holding of Odo of Bayeux in 1086.⁹⁴ The fees held of Adam de Port in the early part of the 13th century included a quarter-fee in Pope's Hall in addition to the main manor of Buckland.⁹⁵ In 1166 a whole fee was held of John de Port, Adam's father,⁹⁶ by William de Popleshall (Pope's Hall).⁹⁷ This fee doubtless included lands at Pope's Hall in Boughton Malherbe, co. Kent, held by the Popeshall family.⁹⁸ Moreover, it seems possible that Osbern, who held under Bishop Odo in Buckland in 1086, was identical with the Osbern son of Letard who held Pope's Hall in Kent of the bishop.⁹⁹ The Port barony was one of those which owed castle-ward service to Dover, and ward was due from Pope's Hall in Buckland to this castle.¹⁰⁰ Knight's service due, as in the case of Buckland, to the Ports and St. Johns was not apparently attached to Tonge Castle, but was assigned in dower to Mirabel widow of Hugh second Lord St. John,¹ and afterwards

formed part of the share of one of his daughters, Isabel wife of Luke de Poynings.² The service to Dover Castle was still recorded in 1427.³

In 1249 William de Orleston was holding Pope's Hall in right of his wife Joan.⁴ It is not clear who she was, but she seems to have been heiress of the family of Popeshall, since the Kentish manor of Pope's Hall also descended to the Orleston family.⁵ The connexion between the Popeshall family and this manor is otherwise lacking in definite evidence. William de Popeshall was among those who viewed the royal works at Dover Castle in 1170-1.⁶ Richard de Popeshall, who appointed Geoffrey son of Anger his essoin before the king's justices at Hertford in 1198,⁷ was probably lord of Pope's Hall, co. Herts. Robert son of Richard de Popeshall was hostage to the king for Adam de Port in 1212-13.⁸

Joan wife of William de Orleston joined her husband in a subfeoffment of Pope's Hall Manor to Bertram de Crioll in 1249.⁹ He was to hold by service of half a knight's fee, by the ward due from the manor to Dover Castle, and by a rent of 6d., to be rendered at Pope's Hall, co. Kent. Free warren, a market and fair were granted to Bertram de Crioll in 1252.¹⁰ He subenfeoffed his son Nicholas de Crioll,¹¹ who sold the manor to Philip de Buckland.¹² Richard (de Clare) Earl of Gloucester took possession apparently without any just claim.¹³ Nevertheless it remained with his descendants. His son Gilbert seventh Earl of Gloucester was in possession in 1278¹⁴ and died seised in 1295.¹⁵ After the death of Gilbert, son of the last-named earl, at

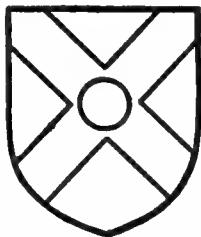

YORKE, Earl of Hardwicke. *Argent a saltire azure charged with a besant.*

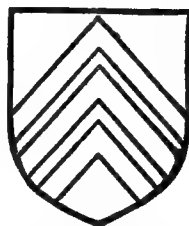

CLARE. *Or three chevrons gules.*

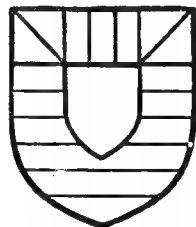

MORTIMER. *Barry or and azure a chief or with two pales between two gyrons azure therein and a scutcheon argent over all.*

Bannockburn in 1314,¹⁶ the custody of Pope's Hall was granted to Ralph de Heron.¹⁷

The manor evidently descended to Elizabeth de Burgh, one of the sisters and co-heirs of the eighth

⁸³ Clutterbuck, *Hist. and Antiq. of Herts.* iii, 393.

⁸⁴ Cussans, *Hist. of Herts. Edwinstree Hund.* 47.

⁸⁵ Chan. Inq. p.m. (Ser. 2), li, 13.

⁸⁶ See above.

⁸⁷ Close, 11 Hen. VIII, no. 2.

⁸⁸ See the account of Chamberlains in Reed; cf. Chan. Inq. p.m. 8 Edw. IV, no. 60.

⁸⁹ Close, 11 Hen. VIII, no. 2.

⁹⁰ Chan. Inq. p.m. (Ser. 2), li, 13.

⁹¹ See above.

⁹² cf. Chauncy, op. cit. 113.

⁹³ *Cal. Close*, 1337-9, p. 20. Evidently to distinguish it from Pope's Hall, co. Kent.

⁹⁴ See above.

⁹⁵ *Testa de Nevill* (Rec. Com.), 270.

⁹⁶ *V.C.H. Hants*, iv, 116.

⁹⁷ *Red Bk. of Exch.* (Rolls Ser.), 208.

⁹⁸ *Testa de Nevill* (Rec. Com.), 208; cf. *Feud. Aids*, iii, 24, 25; *Cal. Close*, 1337-9, p. 20.

⁹⁹ *Dom. Bk. Fac. Kent*, 18.

¹⁰⁰ Feet of F. Herts. 34 Hen. III, no. 401; Chan. Inq. p.m. 22 Ric. II, no. 34; *Cal. Pat.* 1422-9, p. 418.

¹ *Cal. Close*, 1337-9, p. 20.

² *Ibid.* 1349-54, p. 72; cf. *V.C.H. Hants*, iv, 116.

³ *Cal. Pat.* 1422-9, p. 418.

⁴ Feet of F. Herts. 34 Hen. III, no. 401; *Hund. R.* (Rec. Com.), i, 193.

⁵ *Feud. Aids*, iii, 24-5.

⁶ *Pipe R.* 17 Hen. II (Pipe R. Soc.), 137, 138.

⁷ *Rot. Cur. Reg.* (Rec. Com.), i, 172.

⁸ *Cal. Rot. Chart.* 1199-1216 (Rec. Com.), 191.

⁹ Feet of F. Herts. 34 Hen. III, no. 401.

¹⁰ *Cal. Chart. R.* 1226-57, p. 404.

¹¹ Feet of F. Div. Co. case 283, file 13, no. 291.

¹² *Hund. R.* (Rec. Com.), i, 193.

¹³ *Ibid.* In the inquisition on Richard de Clare Earl of Gloucester he is said to have bought the property of Nicholas de Crioll (*Cal. Inq. p.m. Hen. III*, 153).

¹⁴ *Assize R.* 323, m. 45.

¹⁵ Chan. Inq. p.m. 24 Edw. I, no. 107.

¹⁶ *Ibid.* 8 Edw. II, no. 68.

¹⁷ *Abbrev. Rot. Orig.* (Rec. Com.), i, 216.

A HISTORY OF HERTFORDSHIRE

Earl of Gloucester, but was forfeited to the Crown by Roger Damory, her third husband, a contrariant.¹⁸ It was restored to Elizabeth de Burgh in November 1322,¹⁹ and descended to Roger Mortimer Earl of March, grandson of Elizabeth Countess of Ulster, who was granddaughter of Elizabeth de Burgh.²⁰ He was holding the tenement called Pope's Hall at his death, 20 June 1398.²¹ His son Edmund Earl of March gave a life interest in his lands at Pope's Hall to William Barowe,²² and died seised of the reversion in January 1424-5.²³ The tenement evidently came to the Crown at the accession of Edward IV, who was grandson of Anne eldest sister of Edmund Earl of March.²⁴ In the June following his accession he assigned Pope's Hall in dower to his mother Cicely Duchess of York,²⁵ and the grant was confirmed by Richard III.²⁶ She died in 1495.²⁷ The manor afterwards formed part of the dower of Jane Seymour.²⁸ At her death in 1537 it reverted to the Crown, and in 1540 was granted to Sir Ralph Sadleir of Standon, then one of the king's secretaries,

Hall about 1592,³⁵ evidently failed to oust Hamond from the estate or compounded with him, since he was still in possession at his death in 1604.³⁶ His son John Hamond sold Pope's Hall to John Bownest, gentleman, in the early part of 1612.³⁷ He bequeathed it to his wife Mercy with remainder to his son Thomas Bownest,³⁸ who was in possession in 1668.³⁹ His son Thomas sold the estate in 1687 to William Allen⁴⁰ of Great Hadham. From his son Thomas it was purchased in 1714 by the governors of St. Bartholomew's Hospital, West Smithfield,⁴¹ in whom it is still vested. During the 19th century the governors consolidated their estate by the purchase of other lands in Chipping.⁴²

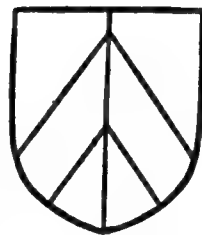

ST. BARTHOLOMEW'S HOSPITAL. *Party argent and sable a chevron countercoloured.*

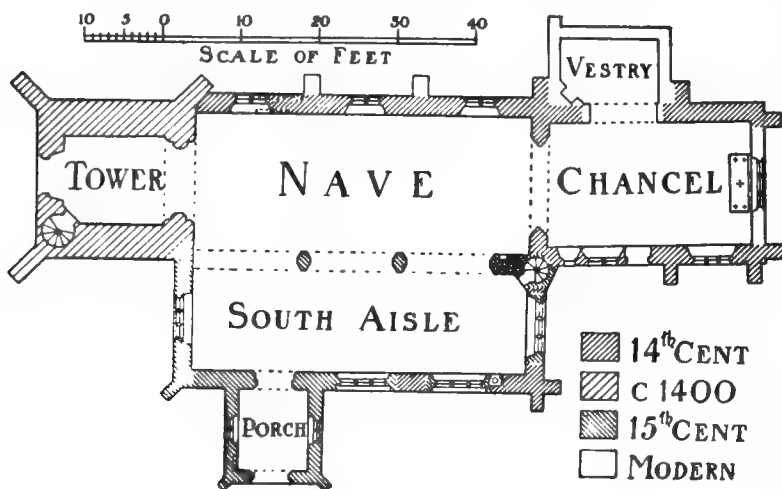

PLAN OF BUCKLAND CHURCH

In addition to court baron⁴³ the lords of Pope's Hall claimed to have gallows, pillory, tumbrel and amendment of assize of bread and ale.⁴⁴ Soon after Richard Earl of Gloucester had seized the manor he withdrew the suit of tenants from the sheriff's courts and retained 5s. from the sheriff's aid.⁴⁵

The church CHURCH of ST. ANDREW⁴⁶ consists of chancel 25 ft. by 16 ft., modern north vestry, nave 43 ft. by 18 ft., south aisle 43 ft. by 13 ft., west tower 12 ft. by 11 ft., south porch 10 ft. 6 in. by 9 ft.; all the dimensions are internal. The walls are built of flint rubble with clunch dressings; the tower is covered with plaster; the roofs are tiled, except over the south aisle, which is leaded.

Salmon⁴⁷ records that the following inscription in the glass of a chancel window existed in his time: 'Nicholai de Bokeland qui istanc Ecclesiam cum Capella Beatae Mariae construxit A° Domini 1348.' The existing chancel, nave and the remains of the south chapel of St. Mary, now incorporated in the south aisle, belong to that period; the west tower was added about 1400, and about 1480⁴⁸ the south

in consideration of his surrender of certain annuities.²⁹ This grant was in tail-male. In 1544 Sir Ralph had a regrant of the same lands in fee simple.³⁰ He sold Pope's Hall to Edward Hamond, a yeoman of Buckland, in 1570.³¹ Edward Hamond settled Pope's Hall on his younger son Alexander in 1578.³² Alexander succeeded his father in February 1579-80,³³ and apparently obtained confirmation of his title from Sir Ralph Sadleir in 1581.³⁴ William Tipper, a 'fishing grantee,' who had a royal grant of Pope's

¹⁸ Mins. Accts. bdlc. 1147, no. 9.

¹⁹ Ibid. See Chan. Inq. p.m. 34 Edw. III, no. 83.

²⁰ G.E.C. *Complete Peerage*, ii, 269; Chan. Inq. p.m. 43 Edw. III, pt. i, no. 23; 5 Ric. II, no. 43.

²¹ Chan. Inq. p.m. 22 Ric. II, no. 34.

²² *Cal. Pat.* 1422-9, p. 418.

²³ Chan. Inq. p.m. 3 Hen. VI, no. 32.

²⁴ G.E.C. loc. cit.; cf. Feet of F. Herts. Mich. 3 Hen. VIII.

²⁵ *Cal. Pat.* 1461-7, p. 131.

²⁶ *Pat. & Ric.* III, pt. v.

²⁷ *Dict. Nat. Biog.*

²⁸ *L. and P. Hen. VIII*, xvi, 379 (26).

²⁹ Ibid.

³⁰ Ibid. xix (2), 166 (70).

³¹ *Pat.* 12 Eliz. pt. ix. The Hamond family had resided at Buckland at least since 1337 (*Cal. Pat.* 1334-8, p. 438).

³² Chan. Inq. p.m. (Ser. 2), clxxxix, 88.

³³ Ibid.

³⁴ Feet of F. Herts. Mich. 23 & 24 Eliz.

³⁵ *Pat.* 34 Eliz. pt. vii.

³⁶ Chan. Inq. p.m. (Ser. 2), cclxxxiv, 96.

³⁷ Feet of F. Herts. Hil. 9 Jas. I.

³⁸ Chan. Inq. p.m. (Ser. 2), cccxlvii, 77.

³⁹ Feet of F. Herts. Mich. 20 Chas. II; Recov. R. Mich. 20 Chas. II, rot. 179.

⁴⁰ Feet of F. Herts. Mich. 3 Jas. II; cf. *ibid.* East. 36 Chas. II; Chauncy, op. cit. 114.

⁴¹ Cussans, op. cit. *Edwinstree Hund.* 48.

⁴² Ibid.; cf. Close, 1862, pt. cli, no. 10; 1864, pt. ii, no. 17; 1865, pt. cxxxvi, no. 8.

⁴³ Mins. Accts. bdlc. 1147, no. 9.

⁴⁴ *Hund. R.* (Rec. Com.), i, 193; Assize R. 323, m. 45.

⁴⁵ *Hund. R.* (Rec. Com.), i, 193.

⁴⁶ There was a churchyard cross on the south side; see will of Richard Gille in 1504 (P.C.C. 23 & 42 Holgrave).

⁴⁷ *Hist. Herts.* (1728), 304.

⁴⁸ In 1497 Thomas Galer left 20s. to the fabric of the church when rebuilding was probably in progress (P.C.C. 6 Horne).

aisle and porch were erected and the west wall of the south chapel destroyed. In the 19th century a north vestry was added and the whole church was restored.

The east window of the chancel with three traceried lights is modern. In the north wall is the modern arch to the vestry; in the south wall are two 14th-century windows, each of two lights with flowing tracery; these have been partially restored. Between them is a doorway of the same date, with moulded jambs and arch. At the western end of the wall is a small low-side window with a square head and a sunk splay on the jambs and lintel outside^{46a}; the window is 2 ft. 2 in. in height by 1 ft. 1 in. in width, and the sill outside is about 3 ft. from the ground. The window is protected by iron bars, and on the inner side are iron hooks on which a casement formerly hung. A moulded string-course under the window sills internally forms the labels over the south doorway and the low-side window. The 14th-century chancel arch is of two chamfered orders, the inner one slightly hollowed, with a moulded label on each side, moulded jambs and moulded capitals and bases; the bases are modern. The chancel roof is modern.

In the north wall of the nave are three windows of 14th-century date, each of two lights with traceried heads. Under the westernmost window is a blocked north doorway of 15th-century date, with low three-centred arch, with two continuously moulded orders, the outer of which forms a square head over the arch. East of the doorway, in the external wall, is a plain round-headed stoup. Set in a splay in the south-east angle of the nave is the doorway to the rood stair; the stair itself has gone, but the upper doorway remains. On the north wall opposite, between the east wall of the nave and the first window, are four corbels which formerly supported the rood-loft; the upper two are 11 ft. from the floor and the other two 2 ft. 6 in. beneath them. They are about 4 ft. apart, those to the west being set in the inner jamb of the 14th-century window, the moulding of which is worked on them.

The south arcade is of three bays and is of about 1480; the two-centred arches are of two moulded orders, the outer one continuous and stopping on a splay half-way down the pier, the inner resting on semi-octagonal shafts with moulded capitals and bases. The western arch of the arcade is about 4 ft. wider than the others and has no western respond, the arch being carried on a corbel carved with an angel holding a shield. Partly buried in the eastern respond of the arcade is a portion of the 14th-century east respond and arch which formerly opened into the south chapel; the details of arch and jambs with their moulded capitals and bases

^{46a} The Rev. H. F. Burnaby states that when this window was reopened in 1848 traces of the painting of a figure in red outline were found on the jambs. cf. p. 48.

are similar to those of the chancel arch. In the eastern respond of the 15th-century arcade are two shallow niches, one on each side back to back; these appear to be the ends of a squint, now blocked. The nave roof is modern.

The south aisle has a window in the east wall, two in the south wall and one at the west end, all of 15th-century date, each of three cinquefoiled lights under a four-centred arch; much of the stonework has been renewed. Below the east window is a 14th-century string-course. The 15th-century south doorway has a four-centred arch of two moulded orders under a square head, with traceried spandrels; much of the stonework has been renewed. In the south-east corner of the aisle is a trefoiled 14th-century

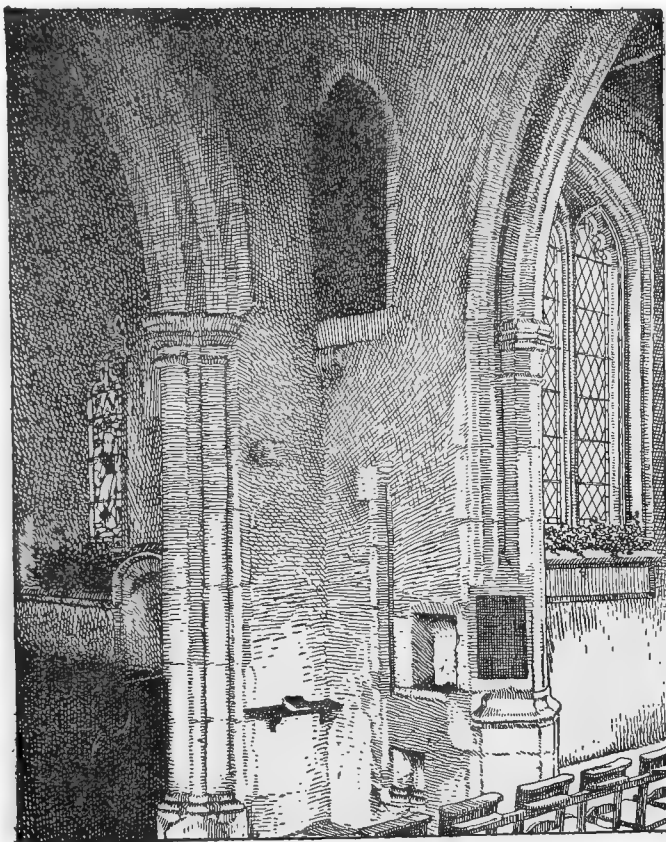

BUCKLAND CHURCH, SOUTH-EAST CORNER OF NAVE, SHOWING JUNCTION OF 14TH AND 15TH-CENTURY WORK

piscina. The roof over the aisle has some 15th-century moulded timbers with carved bosses. The south porch has a flat elliptical arch to the doorway of two moulded orders under a square head; the head stops to the moulded label are much decayed, the inner order rests on moulded capitals. Above the doorway is a small niche with cinquefoiled arch. On each side of the porch is a window with two trefoiled lights under a square head with moulded label and grotesque stops.

The west tower is of three stages with diagonal buttresses; a low pyramidal roof rises behind an embattled parapet. The late 14th-century tower arch is of three moulded orders, the two outer continuous, the inner resting on semi-octagonal shafts

A HISTORY OF HERTFORDSHIRE

with moulded capitals and bases. The west doorway has a late 14th-century arch and jambs of two continuously moulded orders, and decayed grotesque stops to the label. The west window is of two cinque-foiled lights with traceried head, partly of modern stonework. The second stage has a narrow loop-light on three sides. The belfry windows are of two lights with traceried heads and have been repaired.

The font has an octagonal bowl of Barnack stone, perhaps of 14th-century date, but, as it appears to have been recut and its form altered, it is difficult to assign a date to it; the shaft and splayed base are of clunch. All the fittings in the church are modern.

In the heads of two north nave windows are some fragments of 14th-century glass.

On the chancel floor are a brass with the figure of a priest in a cope, holding a chalice, with inscription to William Langley, rector, 1478; a figure of a man with six sons and indent of four daughters, to John Gyll, 1499; an inscription only to Joan Gyll, undated; a female figure with inscription to Alice wife of John Boteler, 1451. Under the communion table is a brass inscription to Joan wife of Esdras Bland, rector, 1648. On the south wall of the aisle is a mural monument of white alabaster to Susan Clerke, 1634.

In the rectory are preserved tracings of the distemper painting discovered, during a restoration, on the sides of the low-side window on the south side of the chancel; on the east side was the Virgin and Child and on the west a female figure in the attitude of prayer. The paintings were destroyed. At the same time there were destroyed in St. Mary's chapel, at the east end of the south aisle, some painted decorations, with an invocation in Latin to the Virgin.

There are six bells: the two old bells by Christopher Graye, 1656, were recast in 1889 and four new ones added.

The communion plate consists of a cup of 1810, a modern paten and a plated flagon.

The registers before 1812 are as follows: (i) baptisms 1659 to 1806, burials 1663 to 1806, marriages 1663 to 1753; (ii) baptisms and burials 1806 to 1812; (iii) marriages 1754 to 1812.

There was a priest at Buckland in *ADVOWSON* 1086.⁴⁹ The advowson was doubtless appurtenant to the manor until Henry de Buckland alienated it in 1283.⁵⁰ He then conveyed it to William de Middleton and John son of Richard de Middleton and the heirs of John.⁵¹ A John de Middleton gave a life interest to Hervey de Staunton in 1319.⁵² At his death it was to revert to John son of John de Middleton.⁵³ He presented a rector in 1336.⁵⁴ The subsequent history is obscure. The advowson seems to have changed hands very frequently. John Wade and

others presented for one turn in 1373, and in 1391 the gift lapsed to the bishop.⁵⁵ Benjamin Cornwall in the same year and John Newport in 1394 presented for one turn only.⁵⁶ John Norwich the elder, a citizen and grocer of London, conveyed the advowson to John Curteys and others in January 1405-6.⁵⁷ Curteys presented a rector in 1409.⁵⁸ In 1432 and 1433 the living was in the gift of John Rinsted and others, and in 1445 John Fray and others presented.⁵⁹ These were probably trustees. By 1478 the advowson had been acquired by John Littlebury *alias* Horne,⁶⁰ who laid claim to Buckland Manor.⁶¹ The advowson is not mentioned in the records of his attempt to recover the manor, but Edmund Lord Roos presented 'for one turn' in 1487.⁶² Sir Thomas Lovell by virtue of his life interest in the lands of Lord Roos laid claim to the advowson as an appurtenance of Buckland Manor in 1503.⁶³ The plea which he brought against Thomas Shuckburgh (probably the grandson of John Horne *alias* Littlebury)⁶⁴ dragged on for more than five years.⁶⁵ The termination is unknown, but it was evidently in favour of the lord of the manor, since the advowson was sold with the manor to Edward Watson by the Earl of Rutland in 1529.⁶⁶ It descended with the manor until the time of Samuel Mellish.⁶⁷ He sold it in 1702 to the Provost and Fellows of King's College,⁶⁸ in whom it is still vested.

Eminent among the rectors of Buckland have been Thomas Becon, the Protestant divine, who wrote under the name of Theodore Basil,⁶⁹ Thomas Morell, a classical scholar, who supplied the libretti for Handel's 'Judas Maccabaeus' and other oratorios, and William Wigan Harvey, who was transferred to Ewelme rectory in 1871.⁷⁰ The Rev. Henry Fowke Burnaby, who succeeded the Rev. W. W. Harvey, restored Buckland Church.

In 1663 the Rev. Esdras Bland, a *CHARITIES* former rector, by his will gave £2 yearly for the education of poor children.

This charge issues out of lands in the parish of Therfield and is paid to the treasurer of Buckland School.

John Clerke's Charity.—A benefaction table formerly in the church recorded 'A.D. 1772. Rent-charge on certain lands in Therfield called Money Crofte by the will of the late John Clerke, Esquire, for bread to be yearly distributed at Christmas, £1.' This annual payment is duly received and applied in accordance with the donor's wish.

In 1898 William Thorogood, by his will proved 20 August, gave £100, the interest arising therefrom to be distributed in coal to the poor annually in December. The legacy was invested in £92 11s. 10d. consols with the official trustees, and the dividends, amounting to £2 6s., are distributed in coal to poor widows.

⁴⁹ *V.C.H. Herts.* i, 310b.

⁵⁰ Feet of F. Herts. 12 Edw. I, no. 156.

⁵¹ *Ibid.*

⁵² *Ibid.* 12 Edw. II, no. 316.

⁵³ *Ibid.*

⁵⁴ *Epis. Reg.* quoted by Clutterbuck, *Hist. and Antiq. of Herts.* iii, 395.

⁵⁵ *Ibid.*

⁵⁶ *Ibid.*

⁵⁷ Anct. D. (P.R.O.), C 3317.

⁵⁸ Clutterbuck, loc. cit.

⁵⁹ *Ibid.*

⁶⁰ *Ibid.*

⁶¹ See above.

⁶² Clutterbuck, loc. cit.

⁶³ De Banco R. 964, m. 431.

⁶⁴ *V.C.H. Herts.* iii, 251.

⁶⁵ De Banco R. 964, m. 431.

⁶⁶ *L. and P. Hen. VIII*, iv, 5624 (20).

Sir Henry Sapcott, kt., who presented in 1533 (Clutterbuck, loc. cit.), was a co-feeffer with Edward Watson.

⁶⁷ See above.

⁶⁸ Clutterbuck, op. cit. iii, 395; *Inst. Bks.* (P.R.O.).

⁶⁹ Urwick, *Nonconf. in Herts.* 739.

⁷⁰ *Dict. Nat. Biog.*

LITTLE HADHAM

The parish of Little Hadham has an area of 3,081 acres, of which about two-thirds consist of arable land.¹ There is now little woodland, but probably like Much Hadham this parish was once well wooded.² The River Ash flows through a valley in the middle of the parish, the ground rising steeply on each side to an average height of 300 ft. Running east and west through the parish is Stane Street, the high road into Essex, and intersecting this is the road running north from Much Hadham to Albury and the Pelhams.

The population of Little Hadham is scattered in hamlets. The church of St. Cecilia is situated a little to the north of Stane Street, and with a few cottages, the Rectory, a modern house built in 1875 and rebuilt in 1907, and Church End House, a 17th-century half-timber house to which a plastered brick front has been added, forms the hamlet known as Church End. A thatched building which stood here, once forming three almshouses belonging to the churchwardens and overseers of Little Hadham, was pulled down about 1886.

Hadham Hall, the manor-house of Bauds' Manor, now the property and residence of Mr. William Minet, F.S.A., J.P., stands on high ground about a quarter of a mile east of the church, with which it is connected by a raised path called the Church Causeway. It consists of the west wing and part of the south wing of a large house of the courtyard type; the other wings have disappeared, but most of the foundations have been traced and a plan of them made. A modern wing has been built partly on the site of the former north wing. The house was probably built about 1570 by a member of the Capell family. There appear to have been two houses before the present one; the first on a moated site a few hundred yards west of the existing house, and another, with which the present house appears to have been partly incorporated, at the south-east corner. In this, as in other points, Hadham Hall resembles Standon Lordship about 4 miles away, a house erected a little earlier in the 16th century. The foundations of the older house, which was probably built in the 15th century by a member of the Baud family, still remain; the orientation of the older building differs 6°20' from that of the existing one. The present house is built of thin 2-in. red bricks. The mullions and dressings to the windows are of brick covered with cement, but some of these have been replaced with modern stonework; the roofs are tiled. The principal front faces west, and is about 115 ft. in length by 26 ft. in width. At its south end a portion of the south wing projects eastwards; the end of this is set back about 14 ft. from the face of the west wing. The house is of two stories with attics. In the centre of the west front is one of the two gateways which formerly gave access to the courtyard; this has been inclosed to form an entrance vestibule. The semi-circular archway is of cement with classic entablature above. On each side of the archway are large semi-octagonal turrets carried up above the roof with

embattled parapets; the one to the south formerly contained a stair; between them is a gable with a saddle-back coping, close under the apex of which is a projecting corbel for a finial, which has gone. All the main front windows are of four lights with moulded mullions and transoms, set in moulded frames and surmounted by pediments; the walls now have a plain parapet with saddle-back coping. The east side of the block has a modern cement archway in the centre, but is without the flanking turrets. The windows are similar to those on the west front, but have no pediments. There are two small doorways on the east front, both now blocked; they probably served as independent entrances to lodgings occupied by guests. The doorways have hollow-chamfered mouldings and four-centred arches. At the north end is a modern doorway.

At each end of the west wing of the house is an original chimney stack of two detached shafts with octagonal moulded caps and bases; the western shaft in each stack is circular, covered with honeycomb pattern, the other a plain octagon. All the other chimneys on the west wing are plain and date from about 1670. The east and west gables of the south wing are crow-stepped, with square early 18th-century chimney shafts set diagonally at their apexes. The lower windows on the south front have splayed brick round-headed arches. The upper windows were formerly mullioned; one remains on the north and one on the west, both blocked, but those on the south were filled with sashes in the 18th century. The south wall of the eastern end of the south wing remains, but all the openings are blocked, with the exception of a wide archway about the centre of the wing, which was formerly the south entrance to the courtyard. The house was in a very bad state when the present owner obtained possession, but he has thoroughly restored it in a conservative spirit, retaining all original work intact where possible. The interior retains many of the original wooden partitions with the old timbers showing. Some moulded beams and four-centred arched doorways of oak remain in the west block, and some of the rooms contain chimney-pieces and panelling put in, probably, about 1633. Some good 18th-century panelling is in the south wing. The staircase, with its semicircular inclosure projecting from the east front, is of 18th-century date.

To the east of the house was a large formal garden of the late 17th century, shown in the picture by Janssen, now at Cashiobury, of Arthur Lord Capell and his family; the positions of the balustraded terrace and the fountains here have been traced. A gate-house stands about 100 yards west of the house; it is of brick, with diaper patterns of black bricks. The central archways are four-centred. A portion of the building is of the 15th century, the remainder, including the archway, of the 16th. A little further to the north-west is a plain late 16th or early 17th-century brick barn, with modern buttresses added in 1902.

A little to the north of Hadham Hall is a moated tumulus.

¹ Statistics from Bd. of Agric. (1905).

² See Much Hadham. In the 13th century the lord of Little Hadham had

meadow in Dene Wood, Westgrove, in the 'grava' called Estwode, &c., which suggests that at this date woods had been

recently turned into meadow (Cott. MS Claud. cxi, m. 163^b).

A HISTORY OF HERTFORDSHIRE

To the west of Church End, at the intersection of Stane Street with the road to Much Hadham, is the hamlet of Little Hadham, or, as Norden calls it, Hadham on Ash,³ by corruption Hadham Nash.⁴ The school to the east of the hamlet was built about 1861. At the south end of the hamlet is a smithy.

Little Hadham Place stands in a park to the west of the Much Hadham road and is now the residence of Lady Braybrooke. The house was formerly a farm called the Hull and was copyhold up to 1876.⁵ To the north of the park is a modern windmill.

Hadham Ford, which lies further south on the road, is the largest hamlet in the parish. There are here several timber-framed and plastered cottages of early 17th-century date, some having panelled plasterwork fronts of the early 18th century. The Independent chapel was built in 1800.⁶ There was within living memory a smithy close by the ford.

story with attics. The house is now divided into three cottages. At the junction of the roofs is a brick chimney stack with two octagonal detached shafts with moulded bases; one of the capitals is gone, the other is modern. The main block is gabled. Some of the windows on the north front have their original moulded oak mullions and transoms; they are not arched, the brickwork resting on the window frames.

At the top of Ford Hill the road forks, one branch, called Hoecroft Lane, running north-east to Green Street, and the other, called Acremore Street, south-east to Bury Green. Acremore Street Farm is a two-storied rectangular building of timber framing covered with plaster and tiled roof. The central brick chimney has square shafts set diagonally. There are some wide fireplaces in the house, partly inclosed with modern cupboards.



CLINTONS, BURY GREEN, LITTLE HADHAM

On the west side of the main road, at the foot of Ford Hill, is an early 17th-century cottage, timber-framed and plastered and with tiled roof. In the front gable is an oriel window on a curved plastered bracket. A large chimney of thin bricks at the south end has wide base and sloping offsets masked by crow-stepped brickwork similar to many other houses in the county. The shafts above are square; the front gable has an oak barge-board pierced with a running pattern.

On Ford Hill, which runs east from the village, is an early 17th-century house,⁷ built of thin bricks, and with tiled roofs. The plan is T-shaped. The main east block, forming the cross to the T, is of two stories with attics; the low west wing is of one

There are several interesting houses at Bury Green, which lies about 1 mile south-east of Hadham Ford. Clintons, south of the Green, the manor-house of Clintons Manor, is now a farm, part of which appears to date from the late 15th or early 16th century. It is an L-shaped building, the main block running east and west, and having a wing at its west end projecting northwards; the main block is in three distinct sections, each containing one room on the ground floor. It is partly timber-framed and plastered and partly of thin bricks. The west end is the earliest; it is narrower than the rest of the block, and seems to be part of the original late 15th or early 16th-century hall. On the ground floor is the dining room, about 17 ft. square, with a wide

³ Norden, *Descr. of Herts.* 19.

⁴ C utterbuck, *Hist. and Antiq. of Herts.* iii, 428.

⁵ Inform. from Mr. W. Minet.

⁶ In 1643 the Dissenting divine, Thomas Pakeman, began to minister at Little Hadham (*Dict. Nat. Biog.*). The house of Ralph Bayford was licensed for a

Presbyterian meeting in 1672 (*Cal. S. P. Dom.* 1672, p. 198).

⁷ Locally believed to have been built as a hospital.

EDWINSTREE HUNDRED LITTLE HADHAM

fireplace in the east wall; this has been reduced by the insertion of a modern stove, leaving the ends with their seats inclosed in cupboards. The hall was originally open to the roof, but in the 17th century a floor was inserted, forming it into two stories. This floor rests on two heavy moulded beams dividing the ceiling into four equal plastered squares; in the centre of each is a square flush-bead panel placed diagonally containing a plaster escarbuncle of the usual type. In the bedroom above is one of the original roof principals. The tie-beam is moulded on the east side only, the west side having a splay on its under edge; this may be due to a later mutilation, or the truss may formerly have been against an end wall. At the south end is a heavy curved brace, about 15 in. by 4 in., with hollow-chamfered edges; the spandrel is filled with tracery in three panels, each having a cinquefoiled arch with tracery under the tie-beam. The brace at the other end has been removed, but the mortise and pin-holes are visible. The internal span of the roof is 17 ft.; it is ceiled a little above the tie-beam. The east end of the block is of 17th-century work, and is built of thin red bricks; the east gable has a large cross and a diaper pattern, all executed in black bricks. The chimney stack at the east end over the kitchen is rectangular; the central shaft has two square shafts set diagonally. In the kitchen, at the east end, is a wide fireplace in which is a modern range; the old seated ends are inclosed in cupboards.

Lower Farm is a little to the east of the Green; it is of two stories with attics. The plan was originally L-shaped, but a modern addition on the south side has made it T-shaped. The north wing is timber-framed and plastered, with tiled roof, and has a chimney stack with a row of four engaged octagonal shafts; it is probably of early 17th-century work. The west wing is entirely of brick, and appears to be a rebuilding of later 17th-century date, although perhaps not so late as 1665, which is painted in modern figures on the gable. On the south side is a projecting chimney built chiefly of thin bricks, but the rest of the brickwork is later in character; round the wing, at the level of the first floor, is a heavy moulded brick string-course, and in the gable is a blocked attic window with square brick label over. The chimney stack has two detached octagonal shafts without bases, having their capitals united. Two of the rooms in the west wing have panelled ceilings, with squares containing plaster escarbuncles (some crowned as on the house by Albury churchyard), double-headed eagles and other devices. Bury Green Farm, on the west side of the Green, now belonging to Mr. Samuel Betts, J.P., is an early 17th-century house of two stories, built of timber-framing and plastered; the roof is tiled. The chimney stack has a row of three square shafts set diagonally. In one of the rooms is a wide fireplace with the seated ends inclosed in modern cupboards.

Green Street is a small hamlet about 1 mile east from Hadham Ford. There is a homestead moat at Green Street Farm. Between Bury Green and

Hadham on Ash lay Mill Field,⁸ which probably took its name from the mill of Bauds' Manor, now no longer standing. North and north-east of Green Street lay Hadham Park. After the additions made by Sir Arthur Capell in 1635 the park extended into the neighbouring parishes of Albury, Bishop's Stortford and Farnham.⁹ The disparking began after the removal of the Capells from Hadham at the end of the 17th century and there are now no traces of the park left.

On the west of the parish Caley Wood, Castle Field and Castles preserve the name of the manor known as the Castle of Cailles. To the north of Caley Wood is Pig's Green, one of the small rectangular greens common in Hertfordshire. There is a hamlet of a few houses at Westland Green, a little further north.

An inclosure award was made for Little Hadham in 1859.¹⁰ In 1277 Southfield, Clude (now Clouds), Westfield, Stocking, Wholmstede, Limstede and Halmstede (Hempstead?) are given as names of fields belonging to the Ely manor and containing apparently both demesne and copyhold lands.¹¹ Later Shirland (Shelland, Shetland), Bugwood, Taskfield (Tassfield) and Nashfield are found as commons shared by both manors (as was also Westfield). Nashfield, adjoining the demesne of Bauds' Manor, had one holding only of the Ely manor. Among other field-names found in the parish are Aury Neck Mead, Troopers, Foxes Field, Gladdings, Readings, The Harp, Market Thorns, Oyster End, Juddle, Great and Little Conry (Conyngery, Conyvers, xvi cent.; Conigree, xviii cent.), Hoowaters (Woowaters, xvi cent.), and Jerveylesfeld (xiv cent., found as Jerdebill's Grove, xv cent., Jarveldes, Jardfeyldes, xvi cent.).¹²

The manor of *HADHAM HALL* or *MANORS BAUDS' MANOR* was divided between three sokemen in the reign of Edward the Confessor. Of these one, a man of Archbishop Stigand, held a hide all but half a virgate, another, a man of Robert Fitz Wimarc, held 3½ virgates, while the third, a man of King Edward, held only 1 virgate and paid 1*d.* to the sheriff.¹³ In 1086 Little Hadham was held by the Bishop of London,¹⁴ and it is afterwards found forming part of the bishop's barony, of which the head was Bishop's Stortford.¹⁵ In the 16th century the manor was said to owe 5*s.* castle-guard rent to Stortford, which was still payable, although the castle was ruinous.¹⁶

A certain William was tenant in fee of the manor of Little Hadham in 1086.¹⁷ The tenants next found in the manor are the family of Baud, who were possibly William's descendants, as they succeeded also to a William's lands in Corringham, co. Essex. In 1166 Simon Baud was holding three knights' fees of the Bishop of London,¹⁸ and these probably included Little Hadham. In 1210 Philip Baud was holding Corringham and 4 hides which are not located but again probably include Hadham.^{18a} Nicholas Baud was holding the manor at the beginning of the 13th century, and by 1242 it had

⁸ See Salmon, op. cit. 281.

⁹ See below under manor.

¹⁰ *Blue Bk. Incl. Awards*, 63.

¹¹ Cott. MS. Claud. C xi (Reg. of Ely), m. 167*b*.

¹² Names from tithe map of 1844 and deeds communicated by Mr. W. Minet.

¹³ *V.C.H. Herts.* i, 306.

¹⁴ *Ibid.*

¹⁵ *Cal. Close*, 1237-42, p. 468; *Plac. de Quo Warr.* (Rec. Com.), 290; *Feud. Aids*, ii, 431, 444; *Chan. Inq.* p.m. i Ric. II, no. 6; (Ser. 2), xxx, 25.

¹⁶ Chauncy, op. cit. 154.

¹⁷ *V.C.H. Herts.* i, 306a.

¹⁸ *Red Bk. of Exch.* (Rolls Ser.), i, 186; see J. H. Round, 'Baud Family,' *Essex Arch. Soc. Trans.* (New Ser.), x, 347.

^{18a} *Red Bk. of Exch.* (Rolls Ser.), ii, 541.

A HISTORY OF HERTFORDSHIRE

descended to his son William, a minor.¹⁹ He died between 1274 and 1278, and was succeeded by his son Walter Baud,²⁰ whose holding in Little Hadham was assessed at half a fee in 1303.²¹ He was Sheriff of Hertfordshire and Essex in 1307²² and was still living in 1313.²³ William Baud, apparently his son, forfeited under Edward II as an adherent of Thomas Earl of Lancaster, but his manor of Little Hadham was restored to him in 1327.²⁴ In 1331 he joined with his wife Joan in settling the manor on his son John,²⁵ who inherited it at his father's death about 1343.²⁶ In 1346 John Baud died in Gascony²⁷ and was succeeded by his son William Baud, kt., who with his wife Alice made a settlement of the manor in 1371.²⁸ William Baud is said to have been the first of this family to reside at Little Hadham,²⁹ and the family was certainly living there in 1404, when William's grandson William Baud was born there.³⁰ William Baud the elder was sheriff for Hertfordshire and Essex in 1371 and M.P. for the county in 1373.³¹ He died before 1388.³² He appears to have been succeeded by his eldest son Walter Baud, who died at Little Hadham in 1420,³³ leaving no issue. The manor then probably passed to his brother John, and on his death in 1422³⁴ to John's son William, who made proof of age in 1425.³⁵ William died the following year without issue,³⁶ and the manor of Little Hadham apparently reverted to his uncle Thomas Baud, third son of William Baud. In 1427 Thomas Baud settled lands in Stortford called 'Plantyngs' on his son Thomas in trust to maintain a chantry priest for three and a half years after his death, to pray for the souls of William Baud and Alice his wife and Thomas Baud the elder and Mary his wife. These prayers were to be said in the church of Little Hadham every Friday and Sunday and on other days in the chapel of the manor-house there.³⁷

Thomas Baud died in 1430,³⁸ and the manor descended to his son Thomas, who was M.P. for the county in 1432 and sheriff for Hertfordshire in 1446-7.³⁹ On his death in 1449 he left the manor of Little Hadham to his son Ralph.⁴⁰ Ralph

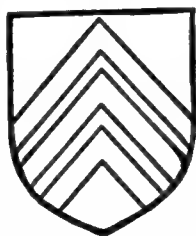

BAUD. *Gules three cheverons argent.*

Baud, who was sheriff for Hertfordshire in 1469,⁴¹ died seised of the manor in 1483.⁴² His son Thomas was made a knight of the Bath in 1494.⁴³ He apparently fell into the hands of Empson, the notorious attorney of the duchy of Lancaster, and a heavy fine imposed upon him for the redemption of his lands compelled him to mortgage his property in 1503,⁴⁴ and in 1504 he sold the manor of Little Hadham to Thomas Lord Darcy.⁴⁵ In January 1504-5 Lord Darcy conveyed the manor to Sir William Capell, kt.,⁴⁶ son of John Capell of Stoke by Nayland, co. Suffolk, and twice Mayor of London.⁴⁷ He died in 1515⁴⁸ and his son Giles succeeded him. In 1519 Sir Giles Capell accompanied Henry VIII to the 'Field of the Cloth of Gold' and was one of the challengers there.⁴⁹ He died in 1556 and his son Henry in 1588.⁵⁰ It was probably Henry who built the present house between 1572



CAPELL. *Gules a lion between three crosslets fitchy or.*

(when he was still living at Rayne) and 1578, when he entertained Queen Elizabeth at Little Hadham.⁵¹ The manor descended to Henry's son Arthur Capell, who was renowned for his hospitality.⁵² Sir Arthur Capell was constantly in communication with Sir Robert Cecil, dating his letters 'from my poor house at Hadham,' at one time asking him for some advancement for his son Edward Capell,⁵³ and at another sending him a fat buck or a pair of does from Hadham Park as a recognition of Cecil's favours.⁵⁴ His eldest son Henry died in 1622,⁵⁵ and in 1627 he settled the reversion of the manor on his grandson Arthur Capell on the occasion of his marriage with Elizabeth Morrison, only daughter of Sir Charles Morrison, bart.⁵⁶ He died in 1632 and was buried at Hadham, and the manor descended according to the settlement to his grandson Arthur Capell,⁵⁷ who represented his county in the Short Parliament of 1639 and again in the Long Parliament of 1640, when he was one of the first members to present a petition against ship money.⁵⁸ Later, however, he became one of the most prominent leaders of the Royalists. In 1641 Charles I created him Lord Capell of Hadham Parva.⁵⁹ He raised a troop of men at his

¹⁹ *Cal. Close*, 1237-42, p. 468.

²⁰ Assize R. 374 A, m. 28 d.; see grant by William in 1274 quoted in Stow, *Survey of London* (1720), pt. iii, 164.

²¹ *Feud. Aids*, ii, 431. In 1309 he presented his son Robert, then under canonical age, to the church of Corringham (Reg. of Bps. of Lond. [Cant. and York Soc.], i, 97).

²² *V.C.H. Herts. Families*, 281.

²³ *Cal. Pat.* 1307-13, p. 605.

²⁴ *Cal. Close*, 1327-35, p. 22.

²⁵ Feet of F. Div. Co. 5 Edw. III, no. 89. John le Baud, parson of Corringham, was an agent in the settlement.

²⁶ See Minet, 'Baud family of Corringham and Little Hadham,' *Essex Arch. Soc. Trans.* (New Ser.), 4, 149.

²⁷ *Ibid.*; Round, loc. cit.

²⁸ See Feet of F. Herts. 45 Edw. III, no. 620.

²⁹ Morant, *Essex*, i, 241.

³⁰ Chan. Inq. p.m. 4 Hen. VI, no. 51.

³¹ *V.C.H. Herts. Families*, 282, 290.

³² Minet, loc. cit.

³³ M. I. given by Chauncy.

³⁴ Chan. Inq. p.m. 1 Hen. VI, no. 53.

³⁵ *Ibid.* 4 Hen. VI, no. 51.

³⁶ *Ibid.* 5 Hen. VI, no. 29.

³⁷ Chauncy, op. cit. 153.

³⁸ M. I. given by Chauncy.

³⁹ *V.C.H. Herts. Families*, 282, 290.

⁴⁰ P.C.C. 18 Rous.

⁴¹ *V.C.H. Herts. Families*, 282.

⁴² Chan. Inq. p.m. 1 Ric. III, no. 6.

⁴³ Shaw, *Knights of Engl.* i, 144.

⁴⁴ Deed in possession of Mr. W. Minet. Richard Empson was one of the mortgagees.

⁴⁵ Deed in possession of Mr. W. Minet.

⁴⁶ *Ibid.* In 1506 Thomas Baud and his wife Anne quitclaimed all right in the manor to John Holden and John Barfote, clk., trustees for Sir William Capell (Feet of F. Herts. Mich. 22 Hen. VII; Deed of release by Thomas Baud to the same to use of Capell in possession of Mr. Minet).

⁴⁷ Stow, *Surv. of London*, v, 127, 182.

⁴⁸ Chan. Inq. p.m. (Ser. 2), xxx, 25.

⁴⁹ Stowe, *Annals*, 509.

⁵⁰ Chan. Inq. p.m. (Ser. 2), cix, 23; ccxvi, 96. It appears that inquisitions were not taken in either case for the Capells' Hertfordshire lands.

⁵¹ J. Nichols, *Prog. of Queen Eliz.* (1823), ii, 222; Glasscock, *Rec. of St. Michael, Bishop's Stortford*, 59.

⁵² *East Herts. Arch. Soc. Trans.* iii, 312.

⁵³ Cecil MSS. (Hist. MSS. Com.), xi, 103, 457, 532; xii, 136.

⁵⁴ *Ibid.* xi, 103; *Cal. S. P. Dom.* 1611-18, pp. 49, 88.

⁵⁵ Chan. Inq. p.m. (Ser. 2), cccxcvi, 148.

⁵⁶ *Ibid.* cccclxv, 54; Feet of F. Div. Co. Mich. 3 Chas. I.

⁵⁷ Chan. Inq. p.m. (Ser. 2), cccclxv, 54.

⁵⁸ F. Skeet, 'Arthur Lord Capell,' *East Herts. Arch. Soc. Trans.* iii, 314; *Diet. Nat. Biog.*

⁵⁹ G.E.C. *Complete Peerage*, s.v. Capell.



LITTLE HADHAM : CLINTONS, BURY GREEN : ROOF SPANDREL IN BEDROOM



HADHAM HALL : PRINCIPAL FRONT

own expense and stored 'arms sufficient to arm about 1000 men' at Hadham Hall, which were seized by the Parliamentarians during his absence in August 1642.⁶⁰ In March 1644-5 Hadham Hall was again visited by the Parliamentarians and forty-four horses and other cattle and stores were carried away. After this time the stables stood empty.⁶¹ Lord Capell had been impeached in 1642 for endangering the peace of the realm by his support of the king. His property was sequestrated and in 1643 the manor-house and park of Little Hadham were among the delinquents' estates charged with the payment of an annuity of £10,000 to the Earl of Essex, captain-general of the Parliamentary forces.⁶² Little Hadham was, however, let to William Capell, uncle of Lord Capell, that he might preserve the houses and woods there.^{62a}

Lord Capell compounded for his estates in 1646-7, on the close of the first war, and retired to live at Hadham Hall. To his influence the outbreak of the second Civil War was largely due.⁶³ He again took up arms, and was one of the Royalist generals besieged in Colchester in 1648.⁶⁴ While he was away the Parliamentarians sent a sergeant and two men to Hadham Hall to seize his son Arthur Capell, then aged sixteen, whom they took to Colchester and carried round the town every day, hoping to influence his father. As this had no effect he was allowed to return home.⁶⁵ In June 1648 Lord Capell's estates were again seized by Parliament and granted to trustees for raising £50,000 for the relief of Ireland.⁶⁶ Colchester surrendered in August 1648 and Lord Capell was sent to the Tower. In March of the following year he was beheaded.⁶⁷ His son Arthur succeeded to his title and claimed his estates. These were ordered to be restored to him, but the order taking no effect he again petitioned Parliament in 1651, claiming that by the settlement of his grandfather Sir Arthur Capell in 1627 the manors of Little Hadham and others had been entailed on him, and that his father had only a life interest. The plea was admitted and the estates restored.⁶⁸ After the Restoration Charles II created Lord Capell Viscount Malden and Earl of Essex in 1661.⁶⁹ He removed to Cashiobury about 1668, after which date the manor-house and demesne lands were turned into a farm, which was for long held in tenancy by the Scott family. The manor descended with the Earls of Essex,⁷⁰ George Devereux de Vere Capell Earl of Essex being the present lord of the manor. In 1900 the greater part of the demesne lands were sold with the manor-house to Mr. William Minet and now form the Hadham Hall estate. The rest of the demesne land was sold at the same time, only the manorial rights being reserved.

In 1275 William Baud had a park and free warren

in Little Hadham.⁷¹ At the beginning of the 17th century the park contained 240 acres. Sir Arthur Capell received licence in 1635 to add to it 500 acres lying in Hadham, Albury, Bishop's Stortford and Farnham.⁷² This was known as Hadham New Park or Wickham Hall and the original park as Hadham Old Park.⁷³ In 1661 Arthur Capell Earl of Essex received a warrant to preserve game within 10 miles of Hadham Hall and Cashiobury.⁷⁴ After the earl moved his residence from Hadham Hall to Cashiobury the parks were leased out and subsequently cut up into the farms of Hadham Old Park Lodge and Wickham Hall.⁷⁵ Some of the deer were removed to Epping Forest and Bagshot Park in 1686.⁷⁶

The manor of *LITTLE HADHAM* is said to have been given to the church of Ely by Ethelflæda wife of Duke Athelstan,⁷⁷ and was included in the charter of confirmation granted to the abbey by Edward the Confessor.⁷⁸ In 1086 the Bishop of London claimed the abbey of Ely's lands in Little Hadham,⁷⁹ but the shire moot testified that these lands had always belonged to the church of Ely and the abbot retained possession. At this date the manor was assessed at 4 hides.⁸⁰ In the reign of William II Ranulph Flambard, Bishop of Durham, seized the manor of Little Hadham. In 1109 the bishopric of Ely was erected and Hervey, the first bishop, obtained a charter of restoration from Henry I.⁸¹ The bishops claimed as their privileges in Little Hadham in 1278 return of writs, gallows, and assize of bread and ale,⁸² and in 1287 they claimed also view of frankpledge and pleas of *namio vetito*.⁸³ Their lands in Hadham were returned as one-third of a knight's fee in 1303.⁸⁴ In the 12th century a mill was erected on the manor, to which the customary tenants paid suit,⁸⁵ and this in 1356 is described as a water-mill. At this date the manor included 300 acres of arable land and 6 of meadow, and the lord was entitled to the labour of four men from August to Michaelmas worth 6½*d.* each. There was also a messuage there which was said to be worth nothing

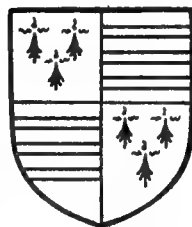

MINET. Or three ermine tails sable quartered with or three bars gules.



BISHOPRIC OF ELY. Azure three crowns or.

⁶⁰ *A perfect Diurnall of the Proceedings in Hartfordshire*, 1642.

⁶¹ *Cal. S. P. Dom.* 1625-49, p. 675; *Hist. MSS. Com. Rep.* xii, App. ix, 45.

⁶² Add. MS. 5497, fol. 133.

^{62a} *Cal. Com. for Comp.* i, 17.

⁶³ F. Skeet, 'Arthur Lord Capell,' *East Herts. Arch. Soc. Trans.* iii, 312.

⁶⁴ *Ibid.*; *Dict. Nat. Biog.*

⁶⁵ *Hist. MSS. Com. Rep.* xii, App. ix, 45.

⁶⁶ *Cal. Com. for Comp.* 1932, 1934.

⁶⁷ *G.E.C. Complete Peerage*, s.v. Capell; *Dict. Nat. Biog.*; *East Herts. Arch. Soc. Trans.* iii, 333.

⁶⁸ *Cal. Com. for Comp.* 1932, 1934. See Feet of F. Div. Co. East. 5 Chas. II.

⁶⁹ *G.E.C. Complete Peerage*, s.v. Essex.

⁷⁰ See Feet of F. Div. Co. Hil. 3 Will. and Mary; *Recov. R. Trin.* 4 Geo. I, rot. 213; *G.E.C. loc. cit.*

⁷¹ *Hund. R. (Rec. Com.)*, i, 193.

⁷² *Cal. S. P. Dom.* 1634-5, p. 585; Clutterbuck, *op. cit.* iii, 411.

⁷³ Deeds communicated by Mr. W. Minet.

⁷⁴ *Cal. S. P. Dom.* 1661-2, p. 182.

⁷⁵ Deeds communicated by Mr. W. Minet; *Salmon, Hist. of Herts.* 281.

⁷⁶ J. Y. Akerman, *Moneys received and*

paid for secret services, 1679-88 (Camden Soc. 52), 135.

⁷⁷ *Hist. Eliensis* (Gale, *Script.* xx, Oxford, 1691), 495.

⁷⁸ *Ibid.* 510; Kemble, *Cod. Dipl.* iv, 244; *Dugdale, Mon.* i, 476.

⁷⁹ *V.C.H. Herts.* i, 307b.

⁸⁰ *Ibid.* 312a.

⁸¹ Bentham, *Hist. and Antiq. of Church of Ely*, 131, App. x, p. 17.

⁸² Assize R. 323.

⁸³ *Ibid.* 325.

⁸⁴ *Feud. Aids*, ii, 432.

⁸⁵ Cott. MS. Claud. C xi, fol. 60.

A HISTORY OF HERTFORDSHIRE

beyond reprises.⁸⁶ In 1400 the tenants of this manor were exonerated from paying the expenses of the knights of the shire in the coming Parliament.⁸⁷

In 1600 Bishop Martin Heton exchanged the manor with Queen Elizabeth for other lands,⁸⁸ and in January 1601-2 Elizabeth granted it with suit of mill, warren, court leet and view of frankpledge to Thomas Bellot and Richard Langley⁸⁹ in trust for Sir Robert Cecil,⁹⁰ principal Secretary of State, who in 1605 was created Earl of Salisbury.⁹¹ In 1607 James I confirmed the grant of Little Hadham to him and his heirs,⁹² and from this time the manor has descended with the Earls and Marquesses of Salisbury,⁹³ the present lord of the manor being James Edward Hubert Gascoyne Marquess of Salisbury.

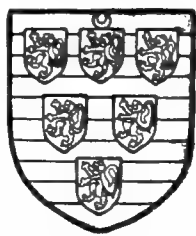

CECIL, Marquess of Salisbury. *Barry of ten pieces argent and azure six scutcheons sable with a lion argent in each and the difference of a crescent.*

There was a park attached to this manor of Little Hadham, a reference to which occurs in 1300.⁹⁴ A grant of free warren had been made in 1251.⁹⁵ The excessive shade caused by the large trees within the park impoverished the pasturage there, which in 1356 was valued at only 3s. 4d.⁹⁶ In the 16th century the park was leased by the bishops.⁹⁷ A house or lodge in it is mentioned in 16th-century grants.⁹⁸ No traces of this park can now be found.

The manor of *WICKHAM HALL* lay partly in the parish of Little Hadham. The estate appears to have been divided in the 16th century, possibly after the death of Sir William Say (see Bishop's Stortford in Braughing Hundred). In 1573 a quitclaim of a twentieth part of the manor lying in Bishop's Stortford, Little Hadham and Albury was made by John Massingberd and Dorothy his wife, one of the heirs of Anne Lady Bouchier, to Anthony Crane.⁹⁹ The following year Crane acquired also the rights of Thomas Housman, another of the heirs, and conveyed two-fifths of one-fourth of the manor to Andrew Malory,¹⁰⁰ who finally purchased the whole of one moiety of the manor.¹ After the death of Malory his widow Elizabeth sold this moiety in 1620 to Robert Symonds of Berden, co. Essex, and Thomas Symonds his son and heir.² In 1629 Thomas Symonds and his wife Philippa sold this half of Wickham Hall to Edward Atkins,³ who with his wife Ursula conveyed it in 1633 to Arthur Capell,⁴

lord of the manor of Hadham Hall. Arthur Capell had already purchased the other half of the Wickham estate (see Bishop's Stortford), and he threw the whole into his park at Hadham, which he was enlarging at the time.⁵ Wickham Hall he converted into a lodge for the keeper of the park.⁶

The manor of *CLINTONS*, called Clyntons *alias* Drax in the 17th century, was held of the Bishop of Ely,⁷ and appears to represent those lands which in the 13th and 14th centuries were called Virlylands.

At the beginning of the 13th century Geoffrey de Verly was holding one-fourth of a fee in Hadham of the Bishop of Ely,⁸ and later in the century this fee is returned as held by John de Verly.⁹ In 1274-5 the estate was held by Thomas de Verly, who claimed free warren in Little Hadham.¹⁰ Thomas was living as late as 1287.¹¹ Virlyland was afterwards held by Matilda wife of Augustine le Parker, who was possibly an heiress of the Verlys. She died seised of it in 1349, her heir being her son Thomas.¹²

Virlylands afterwards came to Henry Clynton. In a grant of his lands in 1401-2 his lands in Little Hadham are described as being all lands called Austyns, Virliez and Scottes,¹³ and these lands formed the manor of Clintons. In 1396 Henry Clynton enfeoffed John de Baryngton and other trustees of his lands in Little Hadham for a settlement on his wife Margaret for life, with remainder to his cousin Henry de Fylongley in fee, that he might find a chaplain to celebrate for the souls of Roger and Roger, priests and late masters of Henry Clynton. If Henry de Fylongley died before Henry or Margaret the lands were to be sold to the highest bidder and the profits expended in masses.¹⁴ Henry de Fylongley appears to have died before Henry and Margaret, for the trustees enfeoffed John Pluknet. He forfeited before February 1407-8 and his lands were granted by the king to John Rasse for life.¹⁵ In 1413 the trustees claimed the lands,¹⁶ and on the death of John Baryngton his son Thomas Baryngton renewed the claim,¹⁷ but without success. The king made a grant of the lands to his surgeon and his usher in 1439,¹⁸ and in 1462 granted them to Richard Jency for life.¹⁹

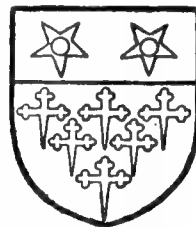

CLINTON. *Argent six crosslets fitchy sable and a chief azure with two molets or pierced gules therein.*

⁸⁶ Add. MS. 6165, fol. 231.

⁸⁷ Ibid. 5847, fol. 125.

⁸⁸ Close, 42 Eliz. pt. xxx; Add. MS. 5847, fol. 125; Gibbons, *Ely Episc. Records*, 12.

⁸⁹ Pat. 44 Eliz. pt. ii, m. 29.

⁹⁰ *Cal. S. P. Dom.* 1601-3, p. 162.

⁹¹ G.E.C. *Complete Peerage*, s.v. Salisbury. ⁹² Pat. 5 Jas. I, pt. xvii.

⁹³ See *Recov. R. Mich.* 20 Jas. I, rot. 90; *Hil.* 7 Anne, rot. 115; *East.* 9 Geo. II, rot. 194; *Mich.* 1 Geo. IV, rot. 223; G.E.C. loc. cit.

⁹⁴ Newcourt, *Repertorium*, i, 829.

⁹⁵ *Cal. Chart. R.* 1226-57, p. 367.

⁹⁶ Add. MS. 6165, fol. 231.

⁹⁷ Ct. of Req. bde. 44, no. 44.

⁹⁸ Pat. 44 Eliz. pt. ii, m. 29; 5 Jas. I, pt. xvii.

⁹⁹ Feet of F. Herts. Mich. 15 & 16 Eliz.; Clutterbuck, op. cit. iii, 412. Anne Lady Bouchier was one of the heirs of Sir William Say. After the failure of her issue she was represented by the heirs of Thomas Say, brother of Sir William Say, of whom Dorothy Massingberd was one (see Berwick in Standon, Braughing Hundred).

¹⁰⁰ Clutterbuck, *Hist. and Antiq. of Herts.* iii, 412.

¹ *Ibid.*; Deeds in Evidence Room at Cashobury.

² Feet of F. Herts. Mich. 18 Jas. I; Clutterbuck, loc. cit.

³ Feet of F. Div. Co. Trin. 5 Chas. I.

⁴ *Ibid.* Hil. 8 Chas. I.

⁵ Deeds in Evidence Room at Cashobury.

⁶ Chauncy, op. cit. 158.

⁷ See Gibbons, *Ely Episc. Records*, 433; *Chan. Inq. p.m.* (Ser. 2), lxxix, 225.

⁸ *Red Bk. of Exch.* (Rolls Ser.), ii, 526.

⁹ Cott. MS. Claud. C xi, 20.

¹⁰ *Hund. R.* (Rec. Com.), i, 193.

¹¹ *Anct. D.* (P.R.O.), A 1013.

¹² *Chan. Inq. p.m.* 27 Edw. III (1st nos.), no. 7.

¹³ *Cal. Pat.* 1413-16, p. 111.

¹⁴ *Anct. D.* (P.R.O.), A 11508.

¹⁵ *Cal. Pat.* 1405-8, p. 389; 1413-16, p. 111. See *Chan. Inq. p.m.* 15 Hen. VI, no. 68; 17 Hen. VI, no. 11.

¹⁶ *Cal. Pat.* 1413-16, p. 111.

¹⁷ *Ibid.* 1429-36, p. 276; 1461-7, p. 338.

¹⁸ *Ibid.* 1436-41, p. 280.

¹⁹ *Ibid.* 1461-7, p. 107.

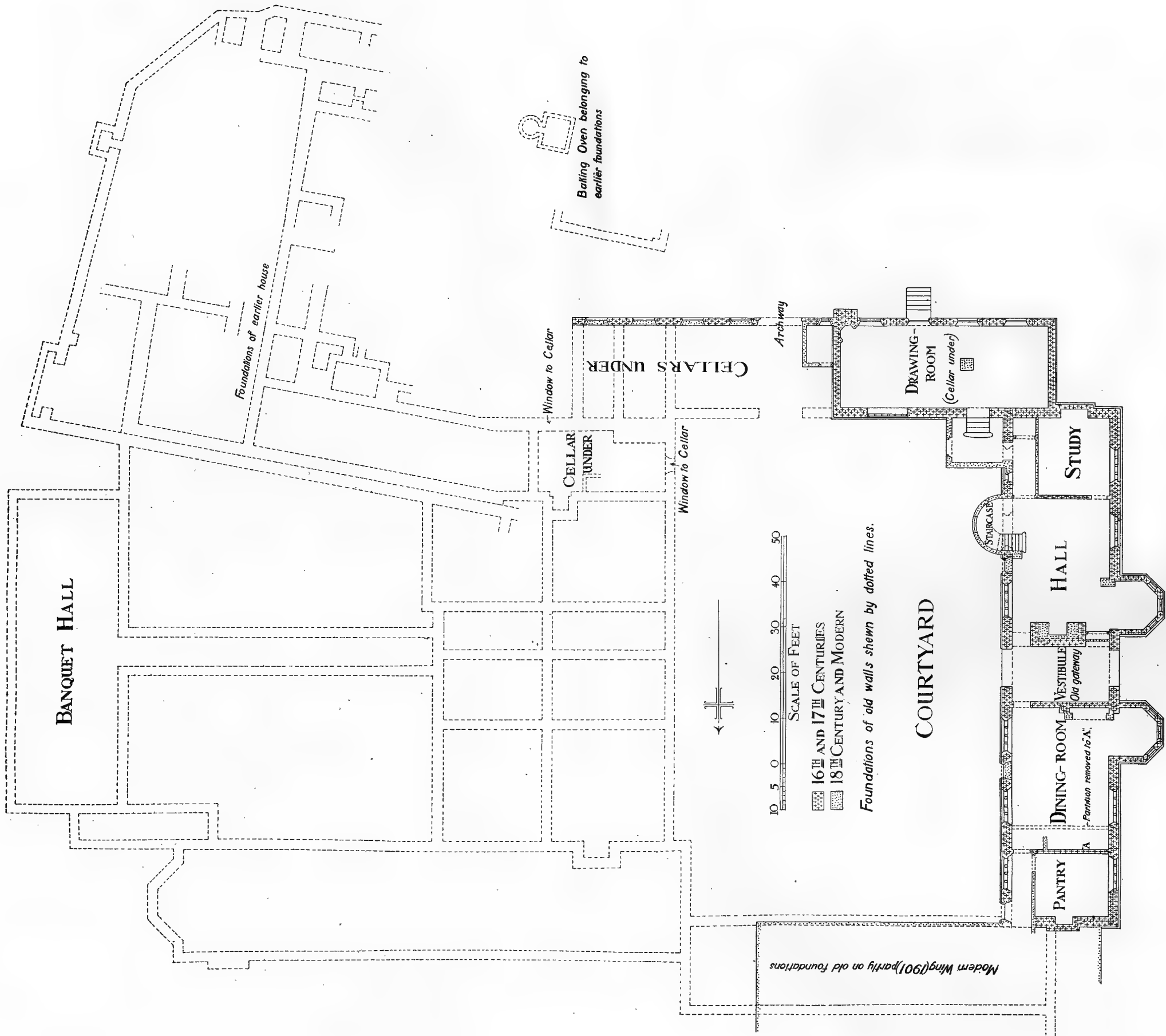

PLAN OF HADHAM HALL

Richard Jeny died in 1481,²⁰ when his widow Elizabeth paid a fine for the custody of his lands.²¹ His heirs were his daughters Margaret wife of Randal Lyttelore and Emma wife of Richard Drax or Drakes.²² Margaret and Randal Lyttelore claimed the manor as Margaret's property by settlement,²³ but the manor remained with Emma and Richard Drakes, and on their death descended to their son Lambert Drakes.²⁴ He probably conveyed it to Henry Patmore (to whom he sold the manor of Joyces (q.v.) in 1513), for in 1520 Henry Patmore died seised of the manor.²⁵ His heir was his son Thomas, but Clintons appears to have been settled on his widow Julian for life, for she joined with her second husband Sir Piers Dutton²⁶ and her son William Patmore in leasing it to Thomas Brett of Little Hadham to hold during her life. After the death of Sir Piers Dutton and William Patmore Dame Julian Dutton and her son Thomas Patmore entered into a part of the farm called Exnynges and threatened to expel Thomas Brett from the rest of the farm called Clintons Hall.²⁷ In 1550 Dame Julian was holding the manors of Clintons and Joyces jointly with her son Thomas, and they received a quitclaim from Edmund Harre and his wife Joan of all Joan's right in the manors.²⁸ From this date Clintons descended with Joyces (q.v.). In 1612 Roland Baugh died seised of the capital messuage called Clintons *alias* Drax, and it passed to his son Edward Baugh.²⁹ No further record of the manor has been found.

Of the manor of JOYCES (Jewel, Jeweys, Jowcys) no early records remain, but in the 14th century there was a family called Joce living in Hadham,³⁰ and it possibly represents their lands. William Rokesburgh, in his will proved 1387, left to his son his goods in the manor of Newgates in Stanstead Abbots and his 'chest at Joces,'³¹ which may be this manor.³² In 1513 Lambert Drax and Cecily his wife were holding Joyces in Cecily's right and sold it to Henry Patmore.³³ Henry Patmore died in 1520,³⁴ and his son Thomas with Dame Julian Dutton, widow, his mother, were holding Joyces in 1550 and received a quitclaim from Edmund Harre and Joan his wife³⁵ (whose interest has not been ascertained) of all Joan's right in the manor. The family of Patmore afterwards took the name of Grimsditch.³⁶ In 1560³⁷ and 1566³⁸ Joyces appears in the tenure of John Grimsditch and Elizabeth his wife. In 1576 Thomas Grimsditch made a conveyance to Sir Ralph Sadleir,³⁹ kt., and another to Henry Sadleir and Richard Bankes in 1578.⁴⁰ These were probably only for the

purposes of settlement, for in 1585 Thomas Grimsditch sometime Patmore leased his mansion-house with the malt-houses and dove-houses to Augustine Steward of London,⁴¹ and in 1588 he and his wife Margaret conveyed Joyces to Roland Baugh.⁴² In 1595 John Haynes and Mary his wife conveyed all right in the manor of Joyces to Thomas Manastye,⁴³ but their interest was probably only a limited one, for in 1612 it was the subject of a fine levied by John Grimsditch to Edward Baugh.⁴⁴ After this date no further record of the manor has been found.

The manor of the *CASTLE OF CAILES* (Caylys, Caldwynes, xvi cent. ; Callis, Calwines, xviii cent.) was held of the Bishop of Ely as of his manor of Little Hadham.⁴⁵ No record of it has been found before the 16th century, when with the manor of Gatesbury in Braughing (q.v.) it was divided between the heirs of Adam de Gatesbury. Land in Hadham was held by the lord of the manor of Gatesbury in 1320, when he received a grant of free warren in his demesne lands of Much and Little Hadham.⁴⁶ In 1498 Henry Elveden, kinsman and heir of Adam de Gatesbury,⁴⁷ died seised of half the castle or manor of Cailes, and it descended to his granddaughter Denise, who married Humphrey Fitz Herbert of Uphall in Braughing.⁴⁸ The Castle of Cailes together with a grange called Caldwyns (from which it took its alternative name) descended with the manor of Gatesbury⁴⁹ until 1559.⁵⁰ After this date no further record of it has been found until 1718, when it was held with the manor of Bromley Hall in Standon by Edward Elderton and Elizabeth his wife and was sold by them to Charles Cotton.⁵¹ The manor appears to have been afterwards absorbed in the Bromley Hall estate in Standon, which is now held by Mr. Grosvenor Berry.

The church of *ST. CECILIA*^{51a} consists of chancel 26 ft. by 23 ft. 6 in., nave 48 ft. by 23 ft. 6 in., north transept 25 ft. by 23 ft. 6 in., west tower 11 ft. 6 in. square, timber south porch 12 ft. 6 in. by 11 ft., and modern vestry north of the chancel; all the dimensions are internal. The chancel, nave and tower are of flint rubble with stone dressings, the walls of the nave and tower are cement covered, the north transept and vestry are of brick, the south porch is of wood, the roofs are slated except the transept and south porch, which are tiled.

The nave walls may be of 12th-century date, as the north doorway appears to be of that period. The semicircular inner arch of this remains, but the outer opening is filled with a brick window of probably

²⁰ P.C.C. 3 Logge.

²¹ Gibbons, *Ely Epis. Records*, 433. Her name is given as Alice in Early Chan. Proc. bdle. 100, no. 29 and in Richard's will dated 1480 (P.C.C. 3 Logge). In his will he desired to be buried in the church of Little Hadham.

²² Early Chan. Proc. bdle. 100, no. 29; Star Chamb. Proc. Hen. VIII, xiii, fol. 77.

²³ Early Chan. Proc. bdle. 100, no. 29.

²⁴ Star Chamb. Proc. Hen. VIII, xiii, fol. 77.

²⁵ Chan. Inq. p.m. (Ser. 2), lxxix, 225.

²⁶ *Visitation of Chesh.* (Harl. Soc.), 260.

²⁷ Star Chamb. Proc. Hen. VIII, vi, fol. 296.

²⁸ Feet of F. Herts. East. 4 Edw. VI. It is not clear what their interest was.

²⁹ Chan. Inq. p.m. (Ser. 2), cccxxvii, 126.

³⁰ See Anct. D. (P.R.O.), B 4014; *Cal. Pat.* 1301-7, p. 176.

³¹ Lond. Epis. Reg. Braybrook, fol. 394.

³² There were, however, lands called Joyces at Stanstead Abbots.

³³ Feet of F. Herts. Mich. 5 Hen. VIII.

³⁴ Chan. Inq. p.m. (Ser. 2), lxxix, 225.

³⁵ Feet of F. Herts. East. 4 Edw. VI.

³⁶ See Egerton MS. 2599, fol. 101.

³⁷ *Ibid.* fol. 87.

³⁸ Feet of F. Herts. Mich. 8 & 9 Eliz.

³⁹ *Recov. R. Trin.* 1576, rot. 415.

⁴⁰ Feet of F. Herts. Mich. 20 & 21 Eliz.

⁴¹ Egerton MS. 2599, fol. 101.

⁴² Feet of F. Herts. Hil. 30 Eliz.

⁴³ *Ibid.* Hil. 37 Eliz.

⁴⁴ *Ibid.* Mich. 10 Jas. I.

⁴⁵ Chan. Inq. p.m. (Ser. 2), xxx, 47.

⁴⁶ *Cal. Chart. R.* 1300-26, p. 431.

⁴⁷ See manor of Gatesbury in Braughing for descent. In 1513 'land of the manor of Gadesbury called Cayle land' is mentioned as lying in Westfield (Extent of that year communicated by Mr. W. Minet).

⁴⁸ Chan. Inq. p.m. (Ser. 2), xxx, 47.

⁴⁹ See *ibid.* c, 79; Feet of F. Herts. Hil. 32 Hen. VIII.

⁵⁰ *Recov. R. Trin.* 31 Eliz. rot. 547.

⁵¹ Com. Pleas D. Enr. Mich. 5 Geo. I, m. 27 d.

^{51a} The invocation of this church is given on the ordnance map as St. Edmund, but is proved to be St. Cecilia by wills of the 14th and 15th centuries (will of Thomas Potyn, 1349, in Ct. of Husting; will of Thos. Baud, 1449, P.C.C. 18 Rous).

A HISTORY OF HERTFORDSHIRE

early 17th-century date. The chancel may have been rebuilt in the 14th century, but most of the stonework is modern. The west tower was built in the latter part of the 14th century. The south porch was added about 1400, or perhaps a little earlier, and the north transept was probably erected in the early part of the 17th century. In the 19th century the north vestry was added and the whole chancel restored.

The three-light traceried window in the east wall of the chancel is modern. In the north wall is a single-light trefoiled window of modern stonework, and also a modern doorway to the vestry. West of this is a small square-headed window of two splayed orders, which may be of 14th-century date; it bears a likeness to the low-side window at Buckland Church. In the south wall is a single-light window of 14th-century character, mostly of modern stonework. The south doorway is of modern stonework. The second window is of the 15th century, of two cinquefoiled lights under a square head; a few old stones remain.

The north transept is built of 2-in. bricks. In the north wall is a four-light window with plain tracery. The east and west walls have each a three-light window under a four-centred arch. All the windows are of brick cemented. On the east side is a doorway with four-centred arch and splayed jambs of brickwork. The chancel roof is modern. Over the nave is a plain 15th-century roof with moulded beams and traceried spandrels resting on carved stone corbels; one represents a knight with sword and shield and others are grotesques. The north transept has an elliptical plastered ceiling. The south porch is of open timber work. On each side are two bays of four lights each with trefoiled arches; all the mullions are gone. The entrance has a segmental pointed arch, on each side of which is a single trefoiled light. The barge-board is cusped. The work is much worn and defaced.

The west tower is of three stages, with diagonal buttresses, embattled parapet, and slender leaded spire; the belfry stair is in the south-west angle. The tower arch is of late 14th-century date and has two moulded orders; the jambs have circular engaged shafts separated by hollows and moulded capitals and bases. The west doorway has a pointed arch of two moulded orders which die on splayed jambs. The label is moulded and has head-stops. From each stop is carried a vertical string-course similar in section to the label, which stops against the string-course above, under the window, forming a square head over the doorway with traceried spandrels containing blank

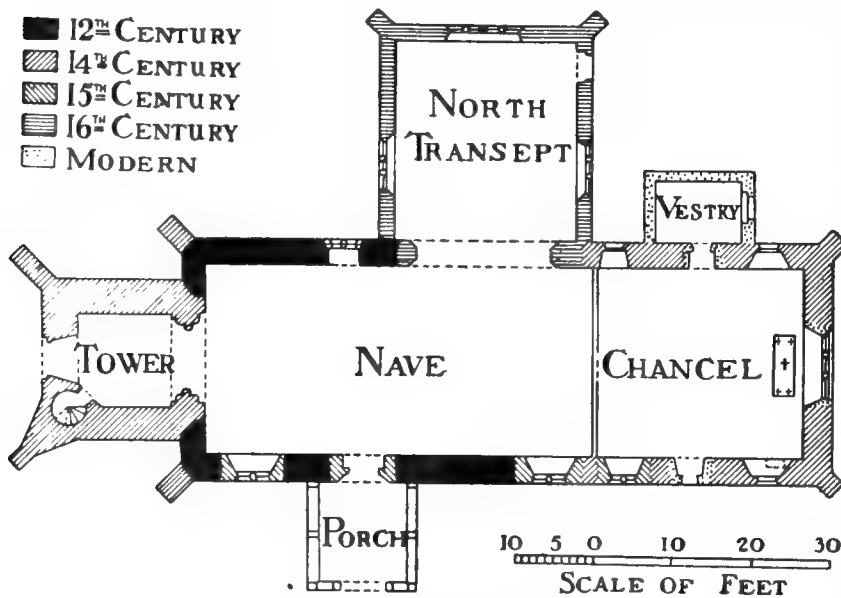

PLAN OF LITTLE HADHAM CHURCH

Near the eastern end of the wall is a late 14th-century piscina with splayed and stopped jambs and cusped arch. The drain is quatrefoiled. There is no chancel arch. On the north side of the nave is the four-centred arch opening into the north transept; it is of three chamfered orders, the middle one hollow; the responds are semi-octagonal and the capitals are moulded. It is all executed in plaster, and is probably of early 17th-century date. The outer arch of the north doorway has been destroyed and the opening blocked with an early 17th-century window of two pointed lights of moulded brickwork covered with cement. In the south wall are two 15th-century windows, each of two cinquefoiled lights with traceried heads. The south doorway is also of 15th-century date with arch and jambs of two moulded orders having a square head and moulded label; the spandrels are traceried and contain blank shields.

The splayed jambs are chiefly of modern stonework, the arch is of clunch, and the label and string-course of a hard oolite.⁵² The west window is of three cinquefoiled lights with modern tracery. In the second stage, on the west and south sides of the tower, are single cinquefoiled pointed lights under square heads; that on the south is blocked. The belfry windows are of two cinquefoiled lights with traceried heads; they have been restored. The font is of stone with plain octagonal bowl and pedestal; it is probably of early 16th-century date.⁵³ The oak chancel screen is of five bays on each side of the central opening; the lower panels are closed and two on each side of the central opening have traceried heads. The rail above is carved on the west side over the four traceried panels with a pomegranate pattern, the other three on each side being plain; these may indicate the positions of former

⁵² At Standon and Clothall, as well as here, oolite has been used in conjunction

with clunch in positions liable to be damaged or weather-worn.

⁵³ In 1823 a fluted pillar served as the

font; this is now in the churchyard. See J. Nichols, *The Progresses of Queen Elizabeth* (1823), ii, 222.



LITTLE HADHAM : 17TH-CENTURY HOUSE, NOW COTTAGES, AT HADHAM FORD

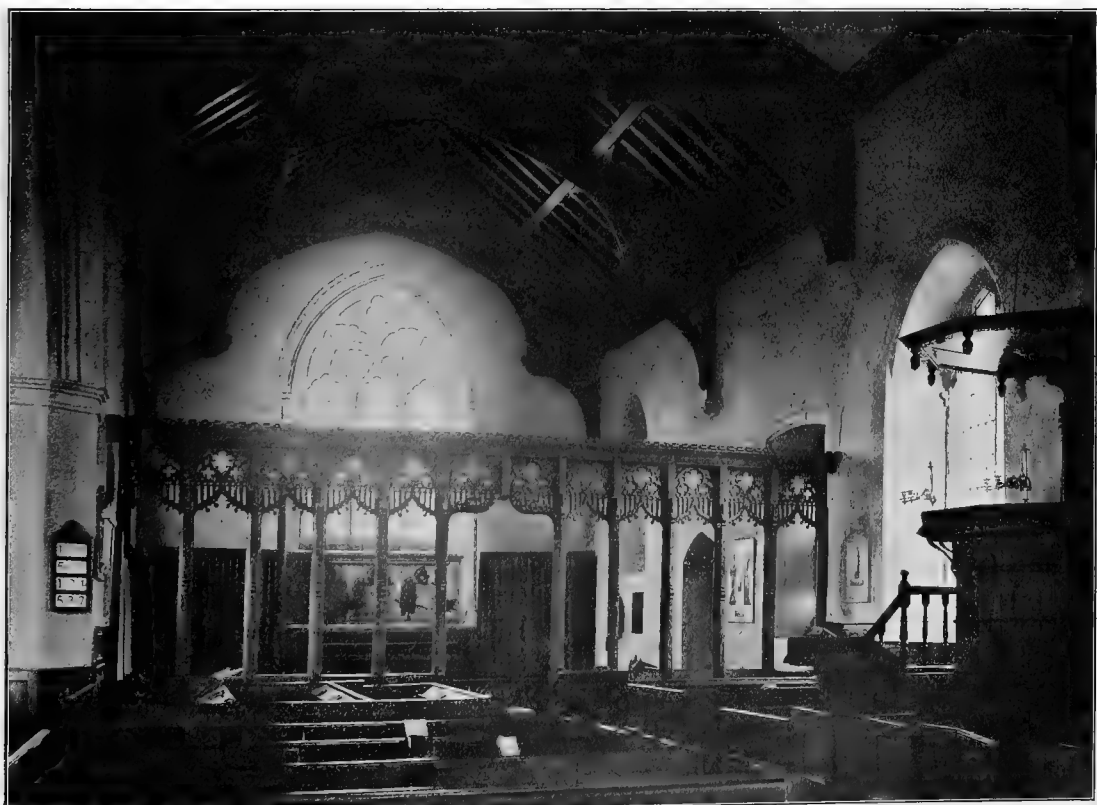

LITTLE HADHAM CHURCH : THE CHANCEL

nave altars.⁵⁴ The space left for each is about 6 ft. The upper part of the screen is open and the heads filled with elaborate but somewhat minute tracery, each arch having similar tracery; the cornice is modern. The screen appears to be of early 16th-century date. The octagonal pulpit is of oak with sounding-board over and is dated 1633. The panels are all richly carved with arabesques. The pulpit is a 'three-decker,' but the lower inclosures are later in date and plain. Round the walls of the north transept is oak panelling of about the same date as the pulpit; the upper panels are carved with arabesques. Some similar panelling remains at the east end of the nave. In the nave are some plain late 16th-century seats. There are some remains of 15th-century glass in the church. In the north-west window of the chancel are the arms of Robert Braybrook, Bishop of

[1461-75]. On the jamb of the vestry door have been fixed three brass strips said to have been found under the floor some years ago; the brass strips are in a perfect state of preservation and have apparently never been used, as there are blanks in the dates. The inscription runs as follows: 'ccccxxxiii et Margareta uxor eius que obiit die mensis anno dñi millesimo cccc quorum animabus propicietur deus amen.' The date is that of the death of Ralph Baud, and his widow may have intended it to be completed after her death, but this was not carried out. A large slab, probably of 13th-century date, with traces of a marginal inscription, is used as a paving stone in the south porch. Within the communion rails are two slabs, one with inscription to Arthur Lord Capell, who was executed in 1649, and his wife Elizabeth daughter of Sir Charles



CHURCH PORCH, LITTLE HADHAM

London (1382-1404), seven voided lozenges, also some fragments of lettering; in the south-east window of the nave are named figures of St. Lawrence and Isaiah. Under the entrance of the chancel screen are a few figured tiles probably of 14th-century date.

On the south wall of the chancel is a brass with figures of a man, his wife and four daughters; it is of early 15th-century date and may represent a member of the Baud family, possibly Walter Baud, who died at Hadham in 1420. It was removed from a slab in the nave floor, which has indents of four shields. On the south wall of the nave is a brass of a priest in a cope, taken from a slab in the nave floor; the inscription is almost illegible,⁵⁵ but it is to 'Syr Richard Warriner, somtyme p'son of Corryngm'

Morrison, d. 1660; the other to Sir Henry Capell, third son of the above, who died in 1696.

There are five bells: the first by C. & G. Mears, 1855; the second by John Dyer, 1595; the third inscribed 'Sancta Gabel (*sic*) ora pro nobis,' probably of the 15th century; the fourth by Robert Oldfeild, inscribed 'Praise the Lord, 1623'; the fifth by Philip Wightman, 1693.

The communion plate consists of two silver cups, two silver patens and one plated flagon, all modern.

The registers before 1812 are as follows⁵⁶: (i) baptisms 1559 to 1695, burials and marriages 1560 to 1695; (ii) baptisms and burials 1695 to 1776, marriages 1695 to 1753; (iii) baptisms and burials 1776 to 1812; (iv) marriages 1754 to 1812.

⁵⁴ Thomas Baud, by his will proved 24 Nov. 1449 (P.C.C. 18 Rous, p. 141), directed his body to be buried before the image of St. Cecilia in Little Hadham

Church; he also bequeathed 6s. 8d. to 'the high altar there.'

⁵⁵ See W. Minet, F.S.A., 'Brasses in

Little Hadham Church,' *The Home Cos. Mag.* vi, 98.

⁵⁶ These registers, ed. by W. Minet, F.S.A., were printed in 1907.

A HISTORY OF HERTFORDSHIRE

The patronage of the church of *ADVOWSON* Little Hadham was held with the manor of Hadham Hall by the family of Baud. In 1276 Sir Walter Baud, lord of the manor, sold all his rights in the advowson to the Bishop of London for £20.⁵⁷ The rectory was soon afterwards united to that of Much Hadham (q.v.), and the church of Little Hadham was a chapel to Much Hadham⁵⁸ until 1875, when Little Hadham was made a separate parish.

The Bishops of Ely held the tithes of their demesne lands in Hadham. In 1220 John of Fountains, then bishop, gave the great tithes to be divided between the monks and the poor on his anniversary.⁵⁹ After the annexation of the rectory of Little Hadham to the rectory of Much Hadham a dispute arose between the priory of Ely and the rector of Much Hadham concerning the tithes payable from the lands of the Bishop of Ely. The Bishop of London adjudicated on this dispute in 1300, when he gave his decision that the great tithes of certain of the Bishop of Ely's lands in Little Hadham and half the tithes of the bishop's mill and of his deer in his park in Little Hadham belonged to the church of Ely, but that the other half of the tithes of his mill and of his deer, together with the tithes of the remainder of his lands, belonged to the rector of Hadham.⁶⁰ The Bishop of Ely's tithes in Little Hadham were valued at 20s. in the reign of Henry VIII.⁶¹ When the bishop sold the manor of Little Hadham in 1600 he retained these tithes, which were still held by the Bishop of Ely at the beginning of the 18th century, when he leased them to the rector of Hadham.⁶²

In 1769 John Hammond, citizen *CHARITIES* and haberdasher of London, by his will directed that a sum of £200 stock

belonging to his estate should be realized and the proceeds invested in land, the rents and profits thereof to be applied for the benefit of poor housekeepers of Little Hadham. The land comprised in deed 21 February 1854 consists of 6 a., part of Miller's Field, which is let at £3 a year.

In 1808 Thomas Chapman bequeathed £100 consols, the dividends to be divided on the last Sunday in January among the poor.

In 1820 John Chapman, by his will proved in the P.C.C., bequeathed £125 stock, now consols, the annual dividends to be distributed in bread.

In 1822 Thomas Mott by his will left £4 a year to be distributed on the third Sunday in January after divine service at church to the twelve poorest in bread, money, or both, poor widows and fatherless children to be preferred. The legacy is now represented by £133 6s. 8d. consols.

In 1837 James Chaplyn by will proved in that year gave £100 consols, the annual dividends to be applied in clothing or firing or both in January.

In 1837 Ann Scott by will proved at this date left £100 consols, the dividends to be distributed in bread to the poor on Shrove Sunday.

The several sums of stock are held by the official trustees, producing in annual dividends £13 19s. 11d.

This parish is also possessed of a sum of £300 consols, producing £7 10s. yearly, arising from a gift of Elizabeth Ann Scott, by deed 26 January 1854, which is standing in the names of Thomas Mott and three other stockholders.

The poor of Little Hadham also participate in the charity of the Rev. Thomas Randolph for poor, and in the charity of George Palmer and others. (See under Much Hadham.)

MUCH HADHAM

Hadham (xi cent.).

The parish of Much Hadham comprises an area of 4,490 acres, of which 12 are water. Rather less than half of the parish consists of arable land.¹ There is now little woodland in Much Hadham, but early records show that there must once have been extensive woods there. In 1086 there was woodland for 330 swine within the area of the two Hadhams.² A wood is mentioned as pertaining to the Bishop of London's manor of Much Hadham in the 13th century,³ and in the 15th century a part of the profits of the manor were obtained by the sale of fuel and charcoal from the lord's wood of Lytley.⁴ Of the few small woods now remaining the Rector's Springs and Vineyard Springs,⁵ Horsley Wood and Nine Acre Wood are in the north-west of the parish, Jobber's Wood is on the east of it, and Side-hill Wood, Culver Wood and Mill Wood, the last apparently near the site of the ancient manorial

mill,⁶ are to the south of the village. The River Ash flows through the parish, and the stream called Fiddler's Brook forms its south-eastern boundary. In the valley of the Ash the ground averages 200 ft. above the ordnance datum. This was probably the 'vale of Hadham' where lay the Bishop of London's liberty into which the king's bailiffs might not enter.⁷ To the east and west of Hadham Cross the ground rises to 300 ft. and in the north-west of the parish reaches a height of 352 ft.

The road running north to Stane Street and south to Widford, Hunsdon and Stanstead Abbots passes through Hadham, and the principal part of the village called Hadham Cross is built along this road. Its situation on the main road gave Hadham a certain importance, and from the 13th century onwards it appears in the various local assessments as one of the largest places in the hundred. At the north end of the village, on the east side of the main road, is the

⁵⁷ Chauncy, op. cit. 159.

⁵⁸ See *Pope Nick. Tax.* (Rec. Com.), 18; *Cal. Pat.* 1345-8, p. 335; 1391-6, p. 492; *Feud. Aids*, ii, 460; *Hist. MSS. Com. Rep.* iv, App. 125; *Inst. Bks.* (P.R.O.), 1674; *Recov. R. East.* 1659, rot. 84.

⁵⁹ Bentham, *Hist. and Antiq. of Church of Ely*, 131.

⁶⁰ *Newcourt, Repertorium*, i, 829.

⁶¹ Dugdale, *Mon.* i, 496.

⁶² Salmon, *Hist. of Herts.* 281.

¹ Statistics from Bd. of Agric. (1905).

² *V.C.H. Herts.* i, 305, 306, 312.

³ *Cal. Close*, 1237-42, p. 401.

⁴ *Mins. Accts.* bdle. 1139, no. 4. Names such as Westredyng, Richard atte Wood, Walworth Shot, Blakshot,

Overshot and Dormer Shot perhaps bear witness to the former extent of woodland in the parish.

⁵ cf. Vineyard Croft as the name of a field (*Close*, 1649, pt. xlvii, no. 40).

⁶ For the manorial water-mill see *Mins. Accts.* bdle. 1139, no. 4; *Rentals and Surv. R.* 813.

⁷ *Hund. R.* (Rec. Com.), i, 193.



LITTLE HADHAM : 17TH-CENTURY COTTAGE AT THE FOOT OF FORD HILL

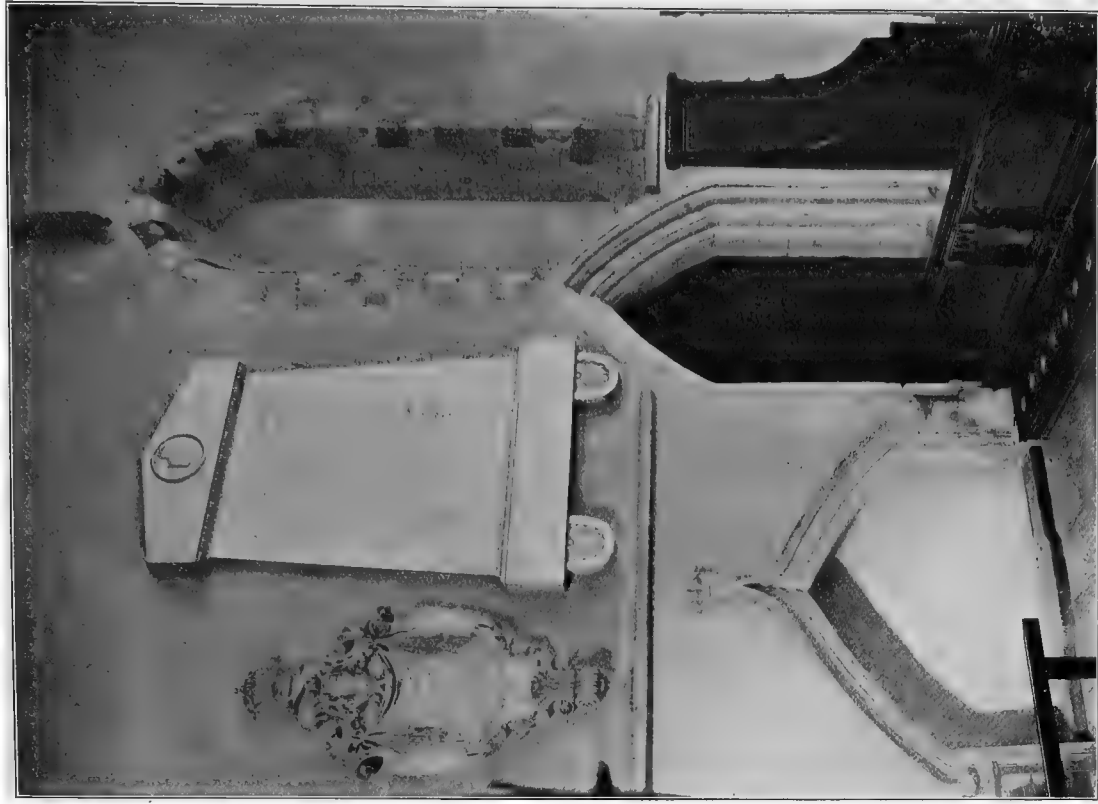

MUCH HADHAM CHURCH : NORTH SIDE OF CHANCEL

Lordship, a large house of early 18th-century date, built of red brick. The cornices have modillions and carved mouldings and all the window sashes are flush with the outside. The house has been altered inside. A range of stables runs up to the main road. Over the central archway is an elaborate bell-turret of wood. There is some good wrought-ironwork in the gates and fencing. South of the Lordship stand the Palace, once a residence of the Bishops of London, and St. Andrew's Church. The Palace is a house of two stories with attics. The walls are of brick and the roofs tile-covered. No part of the existing building appears to be earlier than the 16th century. The oldest part of the house is H-shaped on plan; the connecting block formed the original hall, the principal rooms being placed in the west wing and the domestic offices in the east wing. An 18th-

into five bays. The curved brackets at the ends of the tie-beams have been removed to give head-room in the passage, but the mortise holes in ties and posts are still visible. The principal staircase is in the west wing; it is of late 17th-century date, with square newels with ball tops, heavy moulded balusters and deep beaded handrail. There is a quantity of 17th-century oak panelling in the house, and some of the rooms have carved arabesque friezes. Foundations of walls can be traced in the meadow west of the house, and a bank round the meadow up to the main road marks the old inclosing walls. An avenue of trees formerly led from the south side of the house, where the principal entrance probably was, to the main road west of the site, but only a few trees remain. North of the house are 17th-century stables, the front part of which is built of brick; the wing

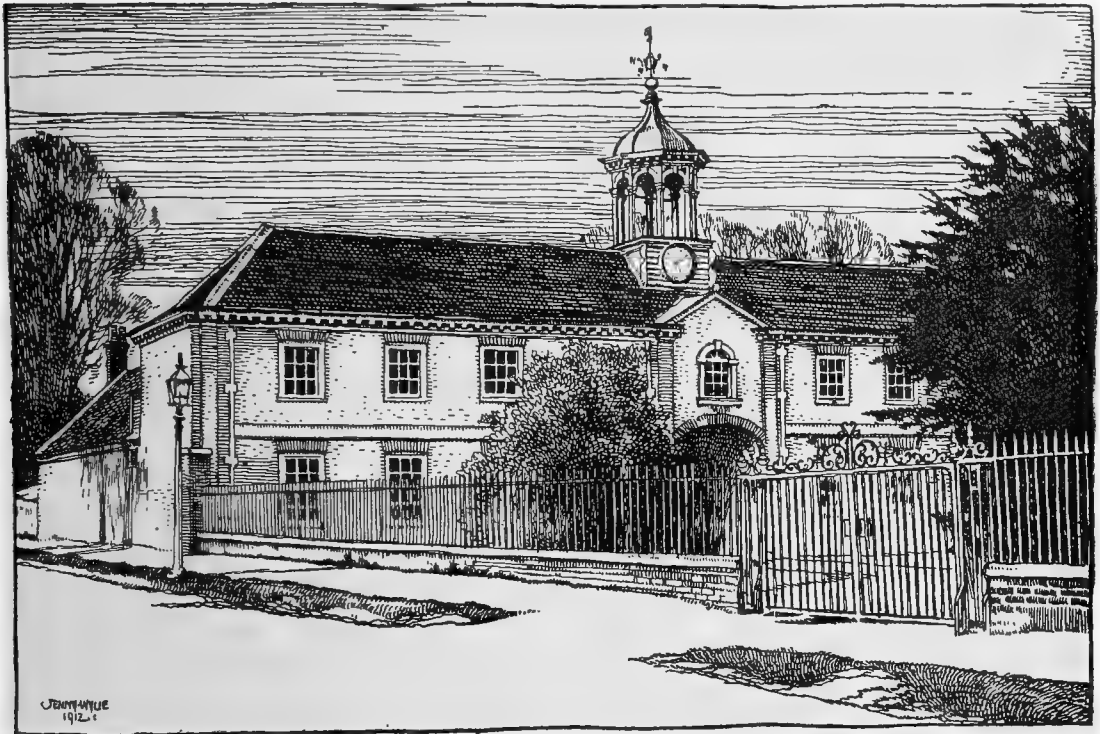

THE LORDSHIP STABLES, MUCH HADHAM

century block was added to the east wing and several modern additions have been made on the north side. In the 18th century the west front was burned and rebuilt. The original house appears to have been timber-framed, but in the latter part of the 17th century the outer walls were encased in brickwork. Both east and west wings are gabled and there are two cross gables over the old hall. All the chimneys are plain, but two are built of early 17th-century bricks. The interior of the house has been much modernized. The hall, which was originally open to the roof, has been divided into two rooms and a floor inserted, making it into two stories; this was probably done in the early part of the 17th century. A passage was also formed along the north side to connect the east and west wings. The old black and white stone paving of the hall still remains, and on the first floor, showing in the passage, are the tie-beams of the 16th-century roof, which was divided

behind is timber-framed and brick-nogged. In the gables of the dormer windows on the west side are plaster devices, two of them being the escarbuncle so common in the district which appears to have been a stock pattern in the 17th century.

The rectory stands to the south of the church. It is a timber-framed and plastered building of early 17th-century date, with modern additions on the east side. The old part is L-shaped, but has been considerably modernized. In the old entrance vestibule, now disused, on the west front is some 17th-century oak panelling and carving. On the first floor are two 17th-century oak chimney-pieces, richly carved and moulded, and some panelling of the same date. All the work has been painted.

There are a number of 17th-century houses in the village, but many have been altered and refaced. On the west side of the road at the south entrance to the village is a cottage known as the Morris

A HISTORY OF HERTFORDSHIRE

cottage; it is of timber framing plastered between the timbers and has an overhanging upper story. On the east side of the road is the Hall, the residence of Mr. H. Bacon, J.P., a plain early 18th-century brick house, standing in its own grounds; it has good wrought-iron entrance gates. There is some more early 18th-century ironwork in front of a small house on the west side of the road near the north end of the village. The school on the east side of the road was founded in 1720.⁸

At the south end of the village stood Hadham Cross.⁹ Near the site of this is Yew Tree Farm,¹⁰ a house of early 17th-century date, timber-framed and plastered between the timbers. The roof is thatched. On the front are two small oriel windows on curved brackets, and in the centre is a roof dormer

house stands in a small park and is the residence of Mrs. Pasteur. Moor Place, the residence of Mr. F. H. Norman, D.L., J.P., stands to the west of the village and appears to be on the site of the park formerly belonging to the Bishops of London.¹¹ An earlier park belonging to the see lay at a considerable distance from the Palace on the south-east of the parish, where the house called Old Park still marks the site of it. In 1199 the Bishop of London gave two parts of the 'Old Park' at Hadham to found a chantry for the souls of the Bishops of London in the lower chapel of the bishop's palace.¹² The pasture in the Old Park was farmed out by the bishops in the 15th century¹³ as well as the lands and pasture of the demesne.¹⁴ Old Hall, to the south-west of Moor Place, now a farm, was once the



YEW TREE FARM, MUCH HADHAM

with the letters wts and date 1697 in the gable; this date probably refers to the dormer only. The two chimney stacks are of thin bricks, with small pilasters on their faces. The Congregational chapel close by was built in 1872. There is a railway station to the south-west of the village on the Buntingford branch of the Great Eastern railway.

Culver Lodge, now the residence of Mrs. William Jowitt, was in 1873 a convent dedicated in honour of the Holy Child Jesus.¹¹ Further south still is the house called Wynches, a name dating from as early as 1610, when the 'tenement called Winches' was occupied by Nicholas Brett, yeoman.¹² The present

property of the Newce family. Close by is Kettle Green, to the south of which, at Moat Farm, is a homestead moat. There is another homestead moat at Brand's Farm, a little to the north-west. This farm is connected with the village by a road called Cox Lane. Cardane Court on the north-west of the village (see manors) is the residence of Mr. Franklyn Arden Crallan. It is a 16th-century house of half-timber on a brick foundation. During recent alterations a stone bearing the initials EN and TH 1682 was found. Some of the rooms have 16th-century panelling and two contain fine open fire-places

⁸ See Charities.

⁹ This is mentioned in 1663 (*Sess. R. [Herts. Co. Rec.], i, 156*).

¹⁰ There was an earlier house called by

the same name; see Cussans, *Hist. of Herts. Edwinstree Hund.* 171.

¹¹ Cussans, loc. cit.

¹² Will printed in *Herts. Gen. and Antiq.* ii, 104.

¹³ See Moor Place under manors.

¹⁴ Chauncy, op. cit. 153.

¹⁵ Mins. Accts. bdl. 1139, no. 14.

¹⁶ *Ibid.*

Perry Green is a hamlet about 2 miles south-east of the village of Much Hadham. The church of St. Thomas was built in 1853 and is a chapel of ease to the parish church. The school stands to the south of it. Hoglands at Perry Green is a small early 17th-century farm-house of timber, partly weather-boarded and partly plastered; the roofs are tiled. The house is of two stories and attics, and at the end is a projecting chimney stack of thin red bricks, with two square engaged shafts set diagonally. The house is gabled, one gable having an original moulded oak barge-board.

About one-third of a mile north-east is Buckler's Farm, a timber-framed house covered with plaster, a part of it weather-boarded; the roofs are tiled. The house was originally L-shaped with a staircase projection in the angle, but modern additions have been made to it. The upper story of the east wing projects on the north and east, and the east gable is

There is a homestead moat at Exnells on the north-east of the parish and others at Sherrards and Mingers Farm.

Anthony Allen, lawyer and antiquary (ob. 1754), was born in the parish of Much Hadham.¹⁸ Of a branch of the Stopes family settled at Much Hadham was Leonard Stopes, one of the four original scholars at St. John's College, Oxford, and one of the four first fellows there. He was ejected from his fellowship on his refusal to conform in 1559 and afterwards suffered imprisonment as a seminary priest.¹⁹ Among the incumbents of Much Hadham have been several distinguished divines. Biographical notices of Alexander Nowell, Peter Hansted, Daniel Dyke, Thomas Paske, and William Stanley, all rectors of this parish, are given by Clutterbuck²⁰ and also by Cussans, who adds a notice of Thomas Patmore, instituted rector in 1515.²¹ Stanley Leathes, the Hebraist, held the living from 1889 to 1900.



BUCKLER'S FARM, PERRY GREEN, MUCH HADHAM

hipped; on the main roof is a chimney stack of thin bricks consisting of a row of square engaged shafts set diagonally on a sloping base; the other chimney is plain. The north gable of the main block has a moulded barge-board with moulded pendant at the apex. One of the first-floor rooms has plaster decorations on the ceiling, consisting of escarbuncles, fleurs de lis and other stock patterns of the district. In another room is some early 17th-century panelling.

Green Tye is another hamlet about 1½ miles south-east of the village. On the north side of Green Tye is an early 17th-century timber-framed and plastered farm-house, with a plain chimney of thin bricks. A fair which used to be held at Green Tye on 23 June was abolished in 1878.¹⁷

The manor of *MUCH HADHAM MANORS* belonged to the Bishops of London before the Conquest,²² but there is no record at what time they acquired it. In 1086 it was assessed at 7½ hides. There was a priest among the tenants of the manor and there was a mill there worth 4s.²³ The manor subsequently formed part of the Bishop of London's liberty of Stortford (q.v.). The bishop's tenants were quit of suit of hundred court²⁴ and the king's ministers were not allowed to enter the bishop's liberty 'in the valley of Hadham' unless the bishop's bailiffs accompanied them.²⁵ Other privileges claimed by the bishop in Much Hadham at the end of the 13th century were free warren,²⁶ gallows and assize of bread and ale,²⁷ view of frankpledge and waifs.²⁸

¹⁷ *Lond. Gaz.* 9 July 1878, p. 4043.

¹⁸ *Dict. Nat. Biog.*

¹⁹ *Ibid.*

²⁰ *Op. cit.* iii, 399.

²¹ Cussans, *op. cit. Edwinstree Hund.* 185.

²² *V.C.H. Herts.* i, 305b.

²³ *Ibid.*

²⁴ *Plac. de Quo Warr.* (Rec. Com.), 290.

²⁵ *Hund. R.* (Rec. Com.), i, 193.

²⁶ *Ibid.*

²⁷ *Assize R.* 323.

²⁸ *Ibid.* 325.

A HISTORY OF HERTFORDSHIRE

The Bishops of London had a residence at Hadham where the king was apparently entertained in 1248, when Letters Patent were dated there.²⁹ Bishop Roger Walden, after having been provided to the see of Canterbury in 1397 shared in the downfall of Richard II, but in 1404 he was provided to London by the efforts of his former rival Arundel. He died at Much Hadham in 1406, less than a year after his consecration.³⁰ At the beginning of the 15th century the Bishop of London found that his revenues were insufficient to keep up all his manors, and he received licence from the pope to dispose of several of them, but Hadham was one that he retained.³¹ Apparently, however, soon after this the palace was leased or lent, for it seems to have been occupied for a short time by Katherine de Valois, widow of Henry V. She married as her second husband Owen Tudor, and her eldest son Edmund Tudor Earl of Richmond, the father of Henry VII, was born at Hadham about 1430 and was styled Edmund of Hadham.³²



BISHOPRIC OF LONDON.
Gules two swords of St. Paul crossed saltirewise.

Bishop Ridley is said to have made use of the neighbourhood of the episcopal residence at Hadham to visit the Princess Mary at Hunsdon House in 1552, in the hope of persuading her to the Protestant religion. She received him graciously, but was indignant at his suggestion that she should hear him preach.³³ After she became queen Bishop Bonner made a visitation in Hertfordshire. At his own town of Hadham he received a poor welcome. The bells, it is said, did not ring to greet him, and in the church the ordinances for the decoration of the rood-loft and the hanging of the sacrament had not been obeyed. The rector pleaded that he had not expected the bishop to arrive so early, but he appears to have been of Protestant sympathies, and Bonner left Hadham in disgust and set out for Ware.³⁴ In 1578 during the episcopate of John Aylmer Queen Elizabeth was at Hadham and held a council there.³⁵ Bishop Mountain was entertaining his friend James Ussher at the palace in March 1625 when the latter heard of his appointment to the archbishopric of Armagh.³⁶

The bishop's possessions were confiscated under the Commonwealth and in 1647 the manor of Much Hadham was granted to William Collins and Robert Staunton,³⁷ who in 1649 received a grant of the warren and game of coney throughout the manor.³⁸ On the Restoration it reverted to the bishopric, but after this date the bishops granted it out on lease, reserving the right of residence.³⁹ In 1868 the temporalities of the bishopric of London were trans-

ferred to the Ecclesiastical Commissioners and they are the present lords of the manor. During the first half of the 19th century the palace was used for many years as a lunatic asylum.⁴⁰ In 1888 the Ecclesiastical Commissioners sold it to Mrs. Berry, who conveyed it in 1893 to Mrs. Wetherall, the present owner.

Among the customs of the manor were a fine of a year's quit-rent paid for admission by the copyholders and free bench for the widows of customary tenants.^{40a}

The estate now known as *CARLDANE COURT* (Celgdene, xi cent. ; Carle Daines, xvi cent.) was held in the reign of Edward the Confessor by Eldred, one of the king's thegns. After the Norman Conquest it was acquired by the Bishop of London and was held of him by Roderi in 1086, when it was assessed at half a hide.⁴¹ It remained with the Bishops of London until after the beginning of the 15th century.⁴² By the end of the 16th century it had come into the possession of the Parnell family.⁴³ Hugh Parnell left it by will of 1594 to his son William, from whom it descended successively to Hugh son of William and Hugh son of Hugh.⁴⁴ The latter settled part of his property on his son Hyde Parnell and Sarah Finch his wife and by will of 1723 left the rest

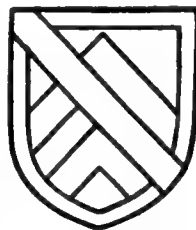

PARNELL. *Gules two cheverons argent with a bend sable and a border or.*

of it to Hyde's son Hugh Parnell. Hugh the younger and Hyde his brother both died without issue and the estate went to their uncle Charles Parnell. William Parnell son of Charles lived at Lambeth and Southwark⁴⁵ and his son Hugh James Richards, a solicitor, owned Hadham House, Upper Clapton. By his will of 1861 he left his Hertfordshire property to his sons Hugh and John Parnell as tenants in common.⁴⁶ In 1906 Carldane Court passed to their cousin Mr. Franklyn Arden Crallan, the present owner (see Patmore Hall in Albury).

In 1086 the Bishop of London held in addition to his manor of Much Hadham half a hide of land in Hadham which before the Conquest had been held by Edric, a man of Asgar the Staller, and which was held of the bishop by William.⁴⁷ This was possibly afterwards parcel of the bishop's manor in Little Hadham which was held by the same tenant in 1086. Another hide of land which two sokemen had formerly had was held of the bishop in 1086 by Osbern,⁴⁸ but its subsequent descent cannot be traced.

The estate called *MOOR PLACE* (Mores, xv cent.) was held of the Bishop of London as of his manor of Hadham.⁴⁹ It appears to have taken its name from a family called More who held lands in

of John Parnell, a tenant of the Bishop of London (Deed *penes* Mr. F. A. Crallan).

⁴⁴ Will of William, 1630; will of Hugh, 1672.

⁴⁵ His sisters Honor and Elizabeth Parnell lived at Castle House, Hadham.

⁴⁶ Descent communicated by Mr. F. A. Crallan.

⁴⁷ *V.C.H. Herts.* i, 306b.

⁴⁸ *Ibid.*

⁴⁹ *Cal. Inq. p.m. Hen. VII.* i, 189.

²⁹ See *Cal. Pat.* 1247-58, p. 32. For letters dated there by the bishops see *ibid.* 1340-3, p. 415; *Cal. S. P. Dom.* 1581-90, p. 111; 1623-5, p. 592; *Hist. MSS. Com. Rep.* viii, App. i, 634a.

³⁰ *Dict. Nat. Biog.*

³¹ *Cal. Papal Letters*, vii, 85.

³² *Dict. Nat. Biog.*

³³ *Fox, Acts and Monuments* (ed. Townsend), vi, 354.

³⁴ *Ibid.* 562-3.

³⁵ *Acts of P.C.* 1577-8, p. 324.

³⁶ *Dict. Nat. Biog.* s.v. Ussher.

³⁷ *Close*, 23 Chas. I, pt. xxxi, m. 20.

³⁸ *Ibid.* 1649, pt. xlvii, m. 40; see *Recov. R. East.* 1659, rot. 84.

³⁹ Chauncy, op. cit. 159; Salmon, *Hist. of Herts.* 277.

⁴⁰ *Sess. R. (Herts. Co. Rec.)*, ii, 317.

^{40a} Cussans, op. cit. *Edwinstree Hund.* 176.

⁴¹ *V.C.H. Herts.* i, 306a.

⁴² *Feud. Aids*, ii, 432, 446.

⁴³ In 1473 there is the manumission



MUCH HADHAM : THE PALACE FROM THE SOUTH-EAST



MUCH HADHAM CHURCH : THE NORTH ARCADE

Hadham in the 15th century. Towards the end of this century John Thresher and Robert More enfeoffed various trustees of lands in Hadham called 'Mores.' These lands included in 1488 a messuage, 100 acres of arable land, 6 acres of meadow and 6 acres of wood. After the death of some of the feoffees the remainder enfeoffed one of their number Thomas Clerke and his wife Elizabeth of these lands. Thomas Clerke was holding in 1488,⁵⁰ and afterwards mortgaged them to James Songer.⁵¹ At the beginning of the 16th century the property called 'Mores' was held by Sir John Champneys, kt., from whom it was purchased by John Haynes the elder in trust for Mary Dalton, widow. In 1550 John Haynes brought a suit against Mary Dalton claiming 10 acres of land belonging to her son Eldred Dalton on account of this transaction.⁵²

Moor Place remained with the Daltons until about 1620,⁵³ when they sold it to Edward Nevill Lord Bergavenny.⁵⁴ He died in 1622.⁵⁵ His son Henry was living in Hadham as late as 1641.⁵⁶ The estate was acquired soon afterwards by Sir John Gore, kt.,⁵⁷ who in 1648 settled the capital messuage called Moor Place and the inclosed land called Hadham Park in which it stood, described as heretofore in the occupation of Sir Gerard Harvey and at that time his own residence, on himself and his wife Katherine in tail-male.⁵⁸ About two years later he conveyed it to Sir Richard Atkins,⁵⁹ who is said to have made a small park on the estate.⁶⁰ He was created a baronet in 1660.⁶¹ He died in 1689,⁶² and Moor Place was sold either before or after his death to James Berners, who died in 1692.⁶³ The estate was afterwards conveyed by William Berners to Robert Atkins.⁶⁴ In 1742 Robert Atkins conveyed Moor Place to William Mills to be sold for payment of his debts.⁶⁵ Lands included in this conveyance were Hunts Wood, Small Gains Pasture, Langley Field, Mappleton Garden, Herringley, a farm called Palmers, and Newclose Brested.⁶⁶ Moor Place was purchased by James Gordon in 1749. He died in 1768, and by the terms of his will it passed to his nephew James Brebner, who took the name of Gordon in 1769. It descended to his son James Gordon and afterwards to James Adam Gordon, who died about 1854. In 1860 Moor Place was acquired by Money Wigram,⁶⁷ and in 1885 it passed to Mr. F. H. Norman, the present owner.

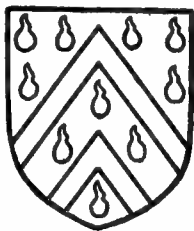

MORE of MOOR PLACE.
Argent sprinkled with drops of blood two chevrons gules.

The present house called Moor Place was built between 1775 and 1779 by James Gordon and is 40 or 50 yards north of the site of the original house. Over the entrance is a coat of arms in stone. The stables and some of the walls in the garden are believed to have belonged to the earlier house.

The capital messuage or farm called *OLD HALL* formed part of the property of Gertrude Marchioness of Exeter, one of the heirs of Sir William Say, and after her attainder in 1539⁶⁸ was granted by the king in 1546 to Sir Richard Lee.⁶⁹ It was then in the tenure of John Rawlyn.⁷⁰ The following year Lee granted his manor of Bigging in Standon to Clement Newce, and the grant included lands in Much Hadham⁷¹ which may probably be identified with Old Hall. Clement Newce was confirmed in his possession of a tenement in Much Hadham by a grant from some of the heirs of Sir William Say in 1575.⁷² In 1579 he died seized of the capital messuage called Old Hall, then in the occupation of William More.⁷³ His heir was his son William Newce. Old Hall afterwards came into the possession of Mark Mott, who settled it on his son Mark Mott, D.D., on the occasion of his marriage with Mercy Dyke, widow. This family also held a messuage in Much Hadham called Watkyns Farm. Dr. Mark Mott, who died in January 1630-1, bequeathed half of his lands to his second son Mark and half to another son, Francis. Mark Mott was aged thirteen in 1637, when his lands in Much Hadham were held by his guardians Samuel Wharton and Adrian Mott.⁷⁴ After this date the descent of this estate cannot be traced.

Besides the Old Hall estate the Newces had other property in Much Hadham. The first of this family known to have been connected with Hadham is Thomas Newce, who in the reign of Edward VI sold one of the church bells and shared the profits with Sir Henry Parker, kt., and Eldred Dalton.⁷⁵ Clement Newce died at Much Hadham in 1579⁷⁶ and his son William died there in February 1610-11.⁷⁷ In 1623 Thomas son of William died in occupation of a mansion-house at Much Hadham.⁷⁸ This descended to his son William, who with his wife Mary and his son Thomas made a settlement of it and other lands in 1648.⁷⁹ William Newce was living as late as 1674, when he was acting justice of the peace.⁸⁰ By 1678 he had been succeeded by his son Thomas,⁸¹ who died before

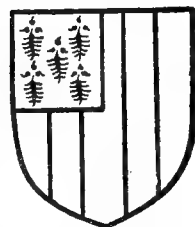

NEWCE of HADHAM.
Sable two pales argent and a quarter ermine.

⁵⁰ *Cal. Inq. p.m. Hen. VII, i, 189.*

⁵¹ Early Chan. Proc. bble. 89, no. 79.

⁵² Ct. of Req. bble. 15, no. 25. The property consisted of a capital messuage and 200 acres of land.

⁵³ Cussans, op. cit. *Edwinstree Hund.* 171.

⁵⁴ G.E.C. *Complete Peerage*, s.v. Abergavenny.

⁵⁵ *East Herts. Arch. Soc. Trans.* ii, 143.

⁵⁶ Add. Chart. 35446.

⁵⁷ *East Herts. Arch. Soc. Trans.* loc. cit.

⁵⁸ See Chan. Enr. Decrees, R. 1870, no. 5.

⁵⁹ Chauncy, op. cit. 160.

⁶⁰ G.E.C. *Complete Baronetage*, iii, 39.

⁶¹ *Ibid.*

⁶² *East Herts. Arch. Soc. Trans.* loc. cit.; M. I. in church. (See Duchy of Lanc. Misc. Bks. lxxii, fol. 59. A manor of Morehall, said to lie in Hadham, is here returned as being held by Thomas Newce in 1678, but this must refer to the manor of Morehall in Thorley.)

⁶³ Chan. Enr. Decrees, R. 1870, no. 5.

⁶⁴ *Ibid.*

⁶⁵ *Ibid.*

⁶⁶ Cussans, loc. cit.

⁶⁷ G.E.C. *Complete Peerage*, s.v. Devon.

⁶⁸ *L. and P. Hen. VIII, xxi (2), g. 648*

⁶⁹ *Ibid.*

⁷⁰ Pat. 1 Edw. VI, pt. viii, m. 8. cf. Biggings in Standon, Braughing Hund.

⁷¹ See Feet of F. Herts. Mich. 17 & 18 Eliz.; Pat. 19 Eliz. pt. iv, m. 25.

⁷² Chan. Inq. p.m. (Ser. 2), clxxxix, 92.

⁷³ *Ibid.* ccccxxxvii, 164.

⁷⁴ *East Herts. Arch. Soc. Trans.* ii, 139.

⁷⁵ Chan. Inq. p.m. (Ser. 2), clxxxix, 92.

⁷⁶ *Ibid.* dxxvii, 99.

⁷⁷ *Ibid.* ccccxxxix, 131.

⁷⁸ Com. Pleas D. Enr. East. 24 Chas. I,

m. 31.

⁷⁹ *Sess. R. (Herts. Co. Rec.), i, 245.*

⁸⁰ Duchy of Lanc. Misc. Bks. lxxii, fol. 59 (see note 63).

A HISTORY OF HERTFORDSHIRE

1700 leaving no male issue.⁸² The mansion-house, which was known as the Hall, came into the possession of the Rev. Francis Stanley, who appears to have been holding it in 1725.⁸³ He rebuilt the house in 1745. On his death in 1775 it was purchased of his executors by Robert Vigne of London, merchant, from whom it passed to George Palmer of Nazeing, co. Essex. It descended to his son Col. George Palmer, who sold it in 1866 to the Rev. Francis Bacon,⁸⁴ and it is now owned by Mr. Henry Bacon, J.P.

At the beginning of the 16th century there was a so-called manor of *DELAMERE* in Much Hadham, of which few records remain. This was purchased by Thomas Ostrich, merchant, of London,⁸⁵ who by his will of 1484 bequeathed torches to the church of Much Hadham, and left all his 'levelod' in Hadham to his wife Anne for life, with remainder to their son Thomas.⁸⁶ After his father's death Thomas brought a suit in Chancery against his mother in order to

of the north aisle is faced with a chequer of flint and stone in 6-in. squares; the main roofs are slated and the aisle roofs covered with lead.

The chancel is the earliest portion of the existing building and was erected about 1220; an earlier nave and chancel probably existed, but no detail of these remains. The chancel arch is also of about 1220, but it was subsequently widened, probably in the 15th century. About the middle of the 13th century a south aisle of three bays was added, probably representing the full length of the original nave. Later in the 13th century the nave and south aisle were lengthened two bays westward, and towards the close of the century a north chapel was thrown out from the east end of the nave, and about the middle of the 14th century the north aisle was formed by extending the chapel four bays westward. Windows were also inserted in the south aisle during the 14th century, and probably also a south doorway, which was subsequently transferred to the north side of the

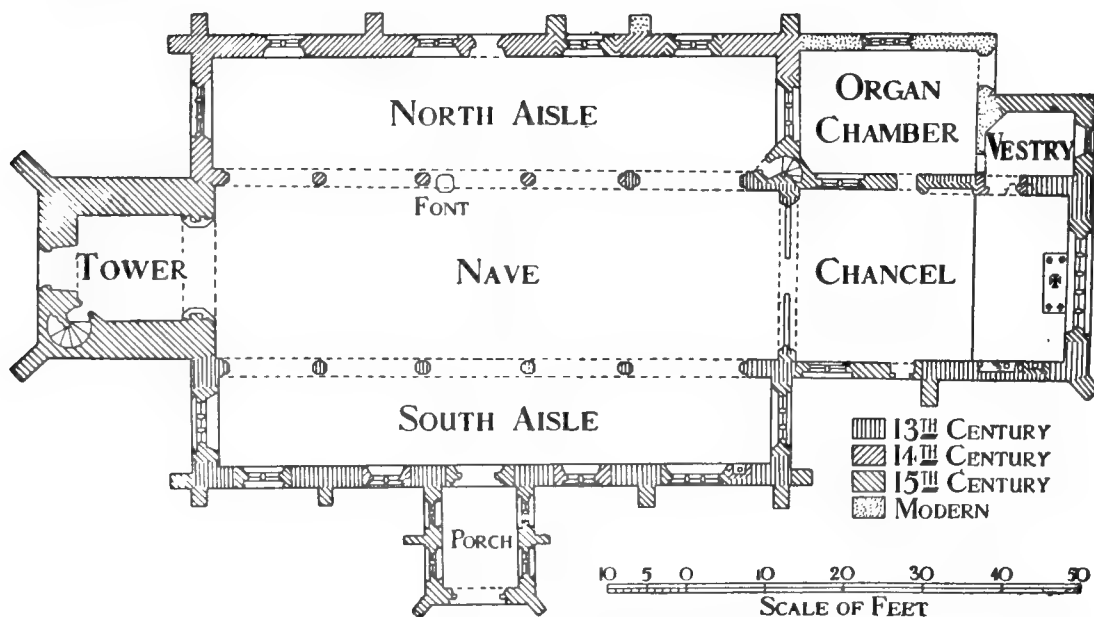

PLAN OF MUCH HADHAM CHURCH

recover the deeds of settlement of the lands in Hadham which were described as the manor of Delamere.⁸⁷

The lands with which the church was endowed formed the *RECTORY MANOR* of Much Hadham.⁸⁸

The church of *ST. ANDREW* standing on the west side of the small River Ash consists of chancel 34 ft. by 21 ft. 6 in., nave 73 ft. by 22 ft. 6 in., north aisle 15 ft. wide and south aisle 12 ft. wide, south porch 13 ft. by 10 ft., west tower 14 ft. square, vestry on the north side of the chancel 11 ft. by 8 ft. 6 in. and modern organ chamber adjoining; all internal dimensions. The walls are of flint rubble with clunch dressings; the tower is covered with cement; part of the west end

chancel as an entrance to the vestry. The west tower was built about 1400 by Robert Braybrook, Bishop of London, whose arms are carved over the west doorway. In the 15th century the walls of the chancel and nave were raised and new roofs put on and the nave clearstory formed; the north vestry was built, the rood-stair was formed, the south porch was erected and a new south door inserted, the older one, with its excellent 13th-century hinges, being probably removed then to the chancel. A number of windows were also inserted during this period. In the 19th century the church was thoroughly restored and much of the stonework renewed, and in 1908 a large organ chamber was erected on the north side of the chancel.

⁸² Chauncy, op. cit. 161.

⁸³ See *Sas. R.* (Herta. Co. Rec.), ii, 60.

⁸⁴ Cussans, op. cit. *Edwinstree Hund.*

172.

⁸⁵ Early Chan. Proc. bdl. 152, no. 56.

⁸⁶ P.C.C. Will, 21 Logge; cf. Early Chan. Proc. bdl. 152, no. 56, where the wife's name is given as Amy.

⁸⁷ Early Chan. Proc. bdles. 152, no. 56; 217, no. 18.

⁸⁸ Newcourt, *Repertorium*, i, 829; Chauncy, op. cit. 160; Clutterbuck, op. cit. iii, 399; Cussans, op. cit. *Edwinstree Hund.* 176.

The east window of the chancel is of 15th-century date and has five cinquefoiled lights with traceried head. In the north wall is an early 13th-century blocked lancet, and partly under, and cutting into it, is a large doorway of about 1350, with arch and jambs of two continuously moulded orders of double ogee mouldings; this opens into the vestry, and has an old oak door formed of planks about 15 in. wide, with fine early 13th-century iron hinges and scroll-work. At the western ends of the chancel walls on each side are lofty shallow recesses about 15 ft. in width of 13th-century date; they appear to be of the full height of the original chancel, and the jambs have splayed edges. A 13th-century moulded string-course under the windows inside is returned into these recesses; they have never been arched, and were apparently originally recesses to give extra width to the chancel; there is nothing to indicate their former depth. They were filled up, probably in the 15th century, when a window of two cinquefoiled lights with traceried head was inserted in each. The window on the north side now opens into the organ chamber. Between the old doorway to the vestry and the doorway to the organ chamber is a recess, probably used as an Easter sepulchre, with continuously moulded arch and jambs and moulded label forming an ogee arch above, with a mutilated carved finial and stops with shields; it is of 15th-century date. The doorway to the organ chamber has a splayed arch and jambs and is of 15th-century date; some of the stonework has been renewed. In the south wall are two 15th-century windows of two cinquefoiled lights. The one at the eastern end has a segmental arched head; the other, in the built-up recess, is similar to that on the north side. The south doorway is of 15th-century date and is similar to that opening into the organ chamber. In the south wall are two piscinas. The most easterly, which is of 15th-century date, has a cinquefoiled arch, nearly elliptical, under a square head; the arch and jambs are moulded. The adjoining one is double, one side being a credence; the arches are trefoiled, and the jambs, arch and central shaft are moulded. In one of the openings is a sixfoiled drain; it is of 13th-century date. The chancel arch is of two chamfered orders, the inner one hollow-chamfered. The jambs have splayed sides and a central engaged circular shaft, slightly keel-shaped. The mutilated capitals are moulded, the bases have gone. The work is of early 13th-century date, but has been taken down and rebuilt with a wider span in the 15th century, the small-sized voussoirs in the upper part of the arch indicating the extension. The chancel roof is of 15th-century date, with roses carved on the soffit of the tie-beams at the centre.

The north nave arcade consists of five bays. The eastern bay, which is wider than the others, formerly opened into the north chapel. It is of late 13th-century date and has an arch of two splayed orders, the inner one hollow-chamfered. There is a moulded label on one side only; the responds are semi-octagonal and the capitals and bases are moulded. The west impost is back to back with the impost of the four western arches, which are of mid-14th-century date with two moulded orders and labels on both sides. The mouldings are enriched with ball-flowers and leaf carvings placed at considerable distances apart. The piers are octagonal, with moulded

capitals and bases; the capitals, which are at a higher level than those of the eastern bay, have human faces and leaves carved on their bells. The south arcade is also of five bays. The three eastern arches were erected about 1240-50, one of two orders, the outer one splayed, the inner with a hollow between fillets and a label on both sides. The octagonal piers have moulded capitals and bases. The two western arches, of about 1260-70, have two orders, one a plain chamfer, the inner hollowed, and plain labels; the piers are octagonal with moulded capitals and bases, the clunch capitals being much mutilated. On many of the stones in the two western arches are roughly cut mason's marks in the form of irregularly shaped crosses potent. The 15th-century clearstory windows have three cinquefoiled lights under a square head. The nave roof is of 15th-century date, with moulded trusses and carved bosses, and with traceried spandrels under the tie-beams resting on stone corbels, some of which bear the symbols of the Evangelists, and others are carved with figure subjects. In the north-east corner of the nave is the upper doorway to the rood-stair, set in a splay.

The three-light east window of the north aisle and the two adjoining two-light windows in the north wall are all of 15th-century date, with cinquefoiled lights and traceried heads. Under the east window is a recess which formerly contained an altar reredos; to the south of it, in the east wall, is a small trefoil-headed piscina with hollow-chamfered edge. In the south-east angle is the doorway to the rood-stair, and beside it is a small blocked trefoiled opening, probably not in its original position. The west window of three lights and the adjoining two in the north wall of two lights are of 14th-century date, with flowing tracery; under the window sills in the west and north walls inside runs a 14th-century moulded string-course, with carvings at intervals as on the arcade arches. The north doorway has continuously moulded arch and jambs of 14th-century date.

The east and west windows of the south aisle are of 15th-century date, each of three cinquefoiled lights with traceried heads. There are four windows in the south wall. The most easterly is a three-light window of 15th-century date, similar to the east window but much restored. The second is of 14th-century date, of two lights, with flowing tracery; the inner jamb has a double ogee moulding and label; much of the stonework is modern. The third window is similar in character, but of modern stonework; the fourth is a 15th-century window of two cinquefoiled lights, with traceried head, restored. The 15th-century south doorway has arch and jambs of two continuously moulded orders under a square head; in each traceried spandrel is a shield, one bearing St. George's cross, the other St. Andrew's. In the east end of the south wall is a 14th-century piscina with cusped arch, slightly ogee-shaped, and carved mutilated finial; the drain is sixfoiled. The south porch belongs to the 15th century. On each side are two two-light windows under four-centred arches; much of the stonework of these is modern. The entrance has a moulded two-centred arch with semi-octagonal shafts in the jambs and moulded capitals; the buttresses have cusped gables. The parapets of the porch and both aisles are embattled.

A HISTORY OF HERTFORDSHIRE

The roofs of porch and aisles are of 15th-century date, the former having carved angel figures.

The west tower is of three stages, with diagonal buttresses, embattled parapet and slender wood spire covered with lead. The circular stair is in the south-west angle. The tower arch is lofty and two-centred; the arch and jambs are splayed and moulded; semi-octagonal shafts with moulded capitals and bases support the inner order. The west doorway has a pointed arch of two moulded orders under a square head and label with head stops; the spandrels are traceried with roses in the centre. The doorway has been repaired; above is a stone shield carved with the arms of Robert Braybrook, Bishop of London

has arched panels with trefoiled cusps, the base is moulded. On the inner sill of the second window from the east is roughly inscribed 'AD NOMEN DOÑI CURVATE GENUA 14—.' A large stone slab under the communion table is said to be the original altar slab turned face downwards. In the recess on the north side of the chancel are some old tiles with geometrical patterns, probably of the 14th century. The rood-screen is of 15th-century date with traceried openings; the cornice is modern. Traces of colour still remain. The oak pulpit is made up of 15th-century traceried panels with pilaster buttresses at the angles. In the chancel are some 15th-century stalls with traceried panels and carved poppy-heads to the seat ends.

There are two 15th-century oak chairs in the church, one in the chancel, the other at the west end, with high panelled and traceried backs with moulded cornice, curved arm-rests with crocketed finials and panelled and traceried fronts. In the nave are some plain 15th-century seats with buttressed ends. On the east wall of the chancel are some 15th-century traceried panels, and on the eastern responds of north and south arcades in the nave is some 17th-century paneling. The communion table is of oak with carved legs of late 16th-century date. In the east window of the chancel are some interesting remains of 15th-century glass. In the upper part are figures of SS. Peter and Andrew. Under them are figures of eight female saints: St. Ursula, St. Cecilia, St. Margaret, St. Mary the Virgin, St. Catherine, St. Winifred, St. Barbara and St. Mary Magdalene.⁸⁹ In the lower part of the window are three sacred monograms, two of them surrounded by the words 'Hoc est nomen quod super omne nomen'; one of the inscriptions is a modern copy. There are also two coats of arms, one of Fulk Bassett, Bishop of London 1244-59 (Barry wavy of six argent and sable), the other of Thomas Kemp, Bishop of London 1450-89 (Gules three sheaves and a border engrailed or).

On the jambs of the blocked 13th-century lancet on the north side of the chancel is a masonry pattern painted in red lines with sixfoiled ornaments, probably of 13th-century date. On the north wall of the north aisle, near the east end, is part of a painted diaper pattern with foliage, probably of 15th-century date, and under the clearstory on the north side of the nave are some small patches of paintings. On the north wall of the vestry is a band of running ornament of 15th-century date.

On the chancel floor is an indent of a floreated cross with a marginal inscription to Simon Flambard, rector (1320-32); a brass strip on a marble slab is inscribed 'Priez pur l'alme Alban parsonne de hadhām'—this is supposed to refer to Alan de Fen, rector (1369-72); an inscription only to Grace Goodman, 1631; the half-figure of a man in the

⁸⁹ *East Herts. Arch. Soc. Trans.* iv, 198.

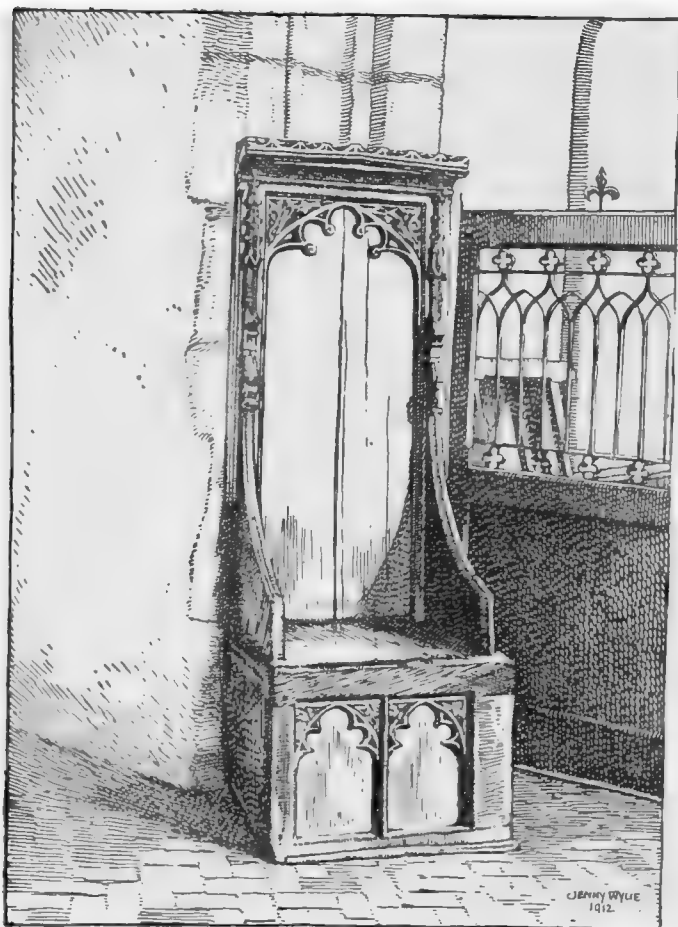

MUCH HADHAM CHURCH: 15TH-CENTURY CHAIR

(1382-1404), seven voided lozenges and a border. The west window has three cinquefoiled lights under a traceried head; the window has been repaired in cement. The second stage of the tower has a loop light on the north, west and south faces and a clock dial on the west. On the east side is a small square-headed opening into the nave over the tower arch which has been blocked with thin 16th-century bricks. The belfry windows have each two cinquefoiled lights with traceried head

The octagonal font is of stone and is probably of late 15th-century date. The sides of the bowl are decorated with circular traceried panels with blank shields and foliage in their centres; the pedestal

dress of a serjeant-at-law, without inscription, of 15th-century date. In the nave: figures of a man and his wife, without inscription, of the early 16th century; inscription only to Joone Goldsmyth, daughter of Clement Newce of London, mercer, and wife of F. Frauncys Goldsmyth of Crayford, Kent; figures of a man and two wives, six sons and seven daughters, with arms and crest and inscription to William Newce, February 1610-11; figures of a man, his wife, eight sons and nine daughters, i.e. Clement Newce, 1579, and his wife Mary, 1582; inscription only to Dianis Burton, daughter of John Knitun of Bayford. On the south wall of the chancel is a mural monument, with headless effigy of Judith Aylmer, widow of John Aylmer, Bishop of London, and mother of Theophilus Aylmer, rector (1589-1626). On the chancel floor are slabs to John Goodman, rector, 1690, and Catherine wife of Dr. William Fuller, Dean of Durham, 1668. There are also slabs to the Parnell family in the floor of the nave.

There are six bells: the first by Samuel Knight, (S. K.), 1738; second by I. H. (John Hodson), 1654; third and fourth by John Dyer, 1595; fifth by S. K. (Samuel Knight), 1738; sixth by Lester & Pack, 1759. There is also a small priest's bell, marked with an arrow, but undated, probably of the 15th century.

The communion plate consists of two silver cups and standing paten, 1576, another paten, 1811, and a modern plated paten and flagon.

The registers previous to 1812 are as follows: (i) baptisms 1559 to 1592 and 1598 to 1682, burials and marriages 1559 to 1682; (ii) baptisms, burials and marriages 1679 to 1748; (iii) baptisms 1748 to 1804, burials 1748 to 1808, marriages 1748 to 1754; (iv) baptisms 1805 to 1812, burials 1808 to 1812; (v) marriages 1754 to 1807; (vi) marriages 1807 to 1812.

The advowson of Much Hadham *ADVOWSON* has always been held by the Bishops of London.⁹⁰ The living of Little Hadham was annexed as a chapelry to Much Hadham in the 13th century.

By will of 1389 Sir Thomas Strete, rector of Much Hadham, founded a chantry in the church for his soul and the souls of his father, mother, sisters and Dom John atte Lee and his wife Joan. He died in 1390.⁹¹

The charities of Mary Hales (will *CHARITIES* dated in 1720) and John Some (will dated in 1772) are regulated by a scheme of the Charity Commissioners of 8 August 1905, whereby the trust funds were divided into two branches:

(a) The educational foundation, endowed with £991 15s. 2½ per cent. annuities, £315 Bank of England stock and £100 consols, producing together about £57 a year, of which £25 a year is under the scheme made applicable in the maintenance of public elementary schools in Much Hadham and the balance towards the cost of apprenticing children from such schools or in training pupil teachers or in prizes or exhibitions for higher education;

(b) The eleemosynary charity, endowed with £352 5s. 2½ per cent. annuities, £105 Bank of

England stock and £41 13s. 4d. consols, producing together about £20 yearly, which is made applicable for the general benefit of the poor in one or more of the modes prescribed by the scheme.

The several securities are held by the official trustees.

In 1689 William Pigott by his will charged his two tenements at the Town's-end and a field called Garret's with an annuity of £1 4s. for providing eight 3d. loaves for the eight poor people living in the almshouses of the parish, which are occupied by poor widows rent free.

In 1772 Charles Baron Deer by his will bequeathed £50, one-twelfth part of the interest to be given away every first Sunday in the month equally to four poor widowers and four poor widows. The legacy is represented by £53 16s. 8d. consols.

In 1799 Hugh Parnell by his will bequeathed £100 consols, the dividends to be applied for the benefit of twelve poor persons on Christmas Eve.

In 1808 Honor Parnell bequeathed £50, the income to be distributed on the last Sunday in January among twelve industrious poor. The legacy is represented by £59 6s. 1d. consols, which has been augmented by £50 consols given upon the same trusts by Elizabeth Parnell.

In 1822 Thomas Mott, by will, left £2 a year to be applied partly in money and partly in bread on the third Sunday in January after service in the morning in the parish church to the twelve poorest families. The legacy is now represented by £66 13s. 4d. consols. The several sums of stock are held by the official trustees, producing altogether £8 4s. 8d. in yearly dividends, which are allocated to the respective charities.

In 1827 James Wildman by his will, proved in the P.C.C., bequeathed £200 stock, now represented (less duty) by £180 consols, the annual dividends, amounting to £4 10s., to be applied for the general purposes of a school of industry or Sunday school or any future school to be substituted.

In 1863 Miss Mary Emily Mott by her will, proved at London 7 December, bequeathed £166 13s. 4d. consols, the annual dividends, amounting to £4 3s. 4d., to be applied towards the education of poor children residing in or about Green Tye, Perry Green and South End districts.

In 1875 the Rev. Thomas Randolph by his will, proved at London 23 June, bequeathed £200 consols, the annual dividends of £5 to be applied in the repairs, maintenance or decoration of fabric and church furniture of the chapel of ease at Perry Green.

The same testator bequeathed £100 consols, the annual dividends of £2 10s. to be applied in gifts of from 5s. to 10s. to the poor of Much Hadham and Little Hadham, preference being given to those who most regularly attend church and holy communion.

In 1878 William Rolph Thornell by his will, proved 23 October in that year, bequeathed £100, now represented by £106 4s. 10d. consols, the annual dividends, amounting to £2 13s., to be distributed immediately before Christmas in tea and cake or otherwise for the refreshment of poor scholars and children of the public school.

Charity of George Palmer and others.—In 1820 a sum of money was raised by voluntary subscriptions 'for the encouragement of industry and good conduct in the labouring poor of the two parishes during

⁹⁰ *Pope Nich. Tax.* (Rec. Com.), 18; *Cal. Pat.* 1381-5, p. 48; *Inst. Bks.* (P.R.O.).

⁹¹ *London Epis. Reg.* Braybrook, fol. 398.

A HISTORY OF HERTFORDSHIRE

their youth by affording them additional comforts in their old age beyond the parish allowance.' The trust fund now consists of £218 8s. consols, producing £5 9s. yearly, which is administered for the benefit

of the aged poor under the provisions of a scheme of the Charity Commissioners of 13 August 1897.

The several sums of stock are held by the official trustees.

GREAT HORMEAD

Hormede (xi cent.).

The parish of Great Hormead is a sparsely wooded district consisting for the most part of fields and meadows. It has an area of 1,968 acres, the proportion of arable land being about two-thirds.¹ The parish has an elevation of from 300 ft. to 400 ft. The soil is mixed, the subsoil mainly clay and the chief crops are barley, wheat and beans.

church runs south-westward as Worsted Lane and crosses the Cambridge Road, on the other side of which it is known as Stonecross Lane. A little to the north-west of the church is the manor-house, Great Hormead Bury, formerly the residence of the Rt. Hon. Sir Robert Romer, P.C., G.C.B., F.R.S., now of Mr. William H. Evans. It appears to have been a half-timbered house, possibly of the 17th



COTTAGE EAST OF VICARAGE, GREAT HORMEAD

The River Quin flows through the parish at the western end, and parallel with the river and at a small distance from it is the main road from London to Cambridge. Grouped along either side of this road are the houses which form the hamlet of Hare Street. The village of Great Hormead itself is in a more isolated position. It lies some distance east of the main road, from which it is separated by the river. The greater part of the village clusters about a winding road leading north-east to Brent Pelham and west to Hare Street, whence after cutting the main road it leads due west to Buntingford. The church stands on a wooded hill-crest just off the road from Little Hormead and about a quarter of a mile south-west of the village. It is connected with the village by Horseshoe Lane, which after passing the

¹ Statistics from Bd. of Agric. (1905).

century, modernized early in the 19th century by Colonel Stables, who was killed at Waterloo. A 17th-century door still remains. On the north side of the road running through the village, adjoining the vicarage on the east, is a timber-framed cottage of late 16th-century date. Part of the timbers at the west end of the upper story are exposed, with plaster between, but the building generally is covered with plaster. The upper story on the south front overhangs; the roof is tiled. Near the centre of the roof is a brick chimney stack with detached octagonal shafts with moulded capitals and bases. At the east end is a stack with two similar shafts, partly rebuilt. The entrance door on the south front has narrow panels and inside are some old doors and a little panelling. About 100 yards further east is a late 16th-century timber-framed house, now divided into



GREAT HORMEAD^s: 16TH-CENTURY HOUSE

EDWINSTREE HUNDRED GREAT HORMEAD

cottages. It is L-shaped on plan and has all the timbering exposed. The lower story of the north wing is of brick; the upper floor on the south front projects. The roofs are thatched and the east and west gables are hipped; all the chimneys are plain.

On the south side of the road, nearly opposite the vicarage, is a timber-framed and plastered cottage, with part of the front upper story overhanging; the roof is tiled. The front has flush panels of plaster filled with combed work; in one panel is a lozenge pattern with moulded ribs and the date 1724.

At Hare Street, three-quarters of a mile west of the village, is a cottage, formerly the Swan Inn, now a private house. It is of timber-framing plastered in front and weather-boarded at the end. The roofs are tiled and the chimney stacks are plain. At each end of the front the gabled upper story overhangs, and beneath are oriel windows on plastered brackets. It is of early 17th-century date. Hare Street House, a farm at the north end of the hamlet, is probably of early 17th-century date, with an 18th-century brick front. The old walls are timber-framed and plastered. The two chimney stacks have detached octagonal shafts with moulded bases; the capitals, which appear to have been rebuilt, are of oversailing courses. The house contains in one room some 17th-century panelling with fluted frieze, also a little panelling of later date.

Hormead Hall, the manor-house of Hormead Redeswell, now a farm-house, stands near the east end of the village. The site is moated, portions of a wet moat remaining on the north, south and east sides. The house is L-shaped on plan; the walls are timber-framed and plastered and the roofs are tiled. It is probably of late 16th or early 17th-century date, but has been altered and modernized and one-story buildings have been erected on the north side. The main block runs east and west, and at its western end is the kitchen wing projecting northwards; the wing has been much modernized. On the roof of the main block is a chimney stack of thin bricks with detached octagonal shafts with moulded capitals and bases; a projecting stack against the west gable has two similar shafts, but without the moulded bases. The windows are modern. In the east room of the main block is a

fireplace of stone with moulded four-centred arch. In the carved spandrels are two shields with arms: one bears a chevron and a label of five points, the other the same arms impaling a chevron between three water bougets. There is a little early 17th-century panelling in the house.

Brick House Farm stands in an isolated position about 1 mile north-east of the village. It is of two stories with attics, and is built of thin 2-in. bricks, with tiled roofs. It was probably built a little before 1579, when Michael Brand granted 'le New Brick House' to James Grymshawe.² The plan is



HARE STREET HOUSE, GREAT HORMEAD

very unusual and is unique in Hertfordshire. The principal block, which measures externally about 28 ft. 6 in. by 23 ft. 6 in., is divided into two rooms; the south room, probably originally the hall, measures 16 ft. 6 in. by 14 ft. 4 in. A modern staircase occupies a part of it, but the original stair was probably formerly in a projecting wing on the west side of the hall and opened directly into it. On the same side is a plain wide fireplace; the kitchen at the north

² Pat. 21 Eliz. pt. vi; see also 28 Eliz. pt. xiii; 29 Eliz. pt. xxviii. For the various extravagant legends connected

with the origin of the Brick House—namely, that it was built by Alfred the

Great or Edgar Atheling—see article by W. B. Gerish in *Home Counties Mag.* iii.

A HISTORY OF HERTFORDSHIRE

end of the block has a wide fireplace on the west side with external oven. At the south end of the main

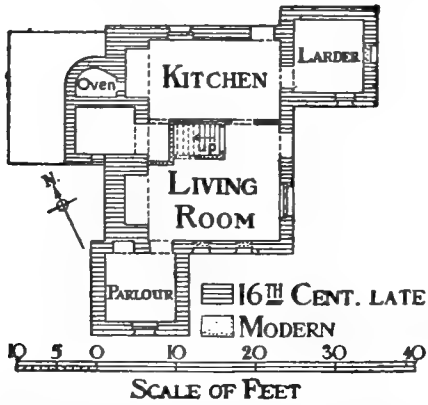

PLAN OF BRICK HOUSE, GREAT HORMEAD

are two large projecting chimney stacks with brick weathered offsets; the plain shafts are L-shaped on one stack and rectangular on the other. There is not much of interest inside the building. Part of the inclosure of the modern staircase is made up of 17th-century panelling; all the window sashes are modern.

About half a mile west of Brick House, on the same road, are the remains of Parsonage Farm. Most of the building was taken down a few years ago. A large chimney stack of early 17th-century date still stands; the shafts are square, set diagonally. On the ground floor is a wide fireplace with wood lintel; some remaining outbuildings are timber-framed and plastered.

In 1086 the manor of *HORMEAD MANORS* formed part of the lands of Edgar Atheling and was held by Godwin. The manor had been increased since the Conquest, the Norman sheriff having annexed to it in all 3 hides and 1 virgate which had been held by Ulwin, one of



THE BRICK HOUSE, GREAT HORMEAD

block is a wing, about 12 ft. square externally, which projects about 2 ft. west of the main building, and on the east side of the main block is a similar wing projecting about 2 ft. beyond the north face; the former is entered from the hall, now a dining room, the latter from the kitchen. The main block and all the wings have crow-stepped gables, but the copings have disappeared. The entrance doorway on the east side of the hall has been modernized. The windows are mostly original, with splayed brick jambs and square heads with labels over; a number of them are blocked. There are a number of curious little window-openings in the walls of the upper stories measuring about 8 in. by 3 in. and having splayed jambs and square heads; they appear in the wings as well as in the main block. One or two are glazed, but most of them are built up. On the west side of the house

Asgar the Staller's men, Alward, a man of Almar of Belintone, and seven sokemen of King Edward.³ After the battle of Tenchebrai in 1106 Edgar Atheling spent the remainder of his life in obscurity, 'perhaps,' says Dr. Hunt, 'on his Hertfordshire property.'⁴ As he died without heirs, it is probable that Hormead with the rest of his property reverted to the Crown.

At the beginning of the 13th century the manor was held by the family of Sanford. They held it of the old feoffment, that is from the time of Henry I. Morant says that it was held with some Essex manors by John de Sanford about 1165.⁵ In 1210-12 John de Sanford was lord of Great Hormead, which he held by serjeanty as chamberlain to the queen.⁶ Gilbert de Sanford, probably his son,⁷ performed the office of chamberlain to the queen at the coronation

³ *V.C.H. Herts.* i, 341b.
⁴ *Dict. Nat. Biog.*

⁵ Morant, *Hist. of Essex*, ii, 56; see Dugdale, *Mon.* vi, 552.

⁶ *Red Bk. of Exch.* (Rolls Ser.), ii, 507; *Testa de Nevill* (Rec. Com.), 270, 279; see Round, *The Queen's Serjeants*, 132 et seq.

⁷ *Coll. Topog. et Gen.* v, 199.

EDWINSTREE HUNDRED GREAT HORMEAD

of Eleanor wife of Henry III in 1236,⁸ and was holding the manor in 1247.⁹ Gilbert de Sanford apparently died in 1250, for in that year the king granted the wardship and marriage of his heirs to the Bishop of London.¹⁰ The manor of Great Hormead formed part of the dower of Lora¹¹ wife of Gilbert,¹² who in 1287 claimed gallowes, view of frankpledge and amendment of assize of bread and ale in Great Hormead.¹³ Lora de Sanford was succeeded by Alice daughter of Gilbert de Sanford and wife of Robert de Vere Earl of Oxford.¹⁴ Alice and her husband held the manor jointly of the barony of Sanford in 1295.¹⁵ The extent of the manor at this date included a water-mill.¹⁶

In 1297, after the death of Robert, Alice made a life grant of the manor to her daughter Hawise, with remainder first to Alfonso, a brother of Hawise, and finally to Alice herself and her heirs.¹⁷ Alfonso appears to have been holding Great Hormead when he died in 1329, and the manor is described in the inquisition as being held of the king in chief by service of guarding the queen's bedchamber on the night following the day of coronation.¹⁸ His heir, who was his son John, received a grant of free warren in 1329.¹⁹ He succeeded his uncle Robert de Vere as Earl of Oxford in 1331. Great Hormead was held by the Earls of Oxford²⁰ until 1471, when John de Vere forfeited by rebellion and the manor was granted to Richard Duke of Gloucester and his male heirs.²¹ Four years later it passed by grant to Sir William Stanley,²² probably as a reward for his loyalty to Edward IV. In 1485, when the Earl of Richmond became king, John de Vere Earl of Oxford was restored by him to all his honours and estates²³ and died seised of the manor of Hormead in 1513.²⁴ The

Earls of Oxford appear to have held the manor until 1579,²⁵ when it was the subject of a fine between Edward Earl of Oxford and Anthony Cage.²⁶ From the evidence of a suit in Chancery in 1588 it seems probable that in 1579 the manor was already leased and that it was the reversion that was conveyed to Anthony Cage. In his petition to Chancery in 1588 Thomas Hammond of Great Hormead declared that Edward de Vere Earl of Oxford had demised the

manor to Walter Hayward for twenty-one years and that the latter in 1586 granted his interest and term of years to the complainant. The reversion of the manor, the petition states, then belonged to Daniel Cage, 'a very covetuous and froward fellowe seekinge by all means possible to inriche himselfe by wranglinge sutes agaynst his pore neighbours.' The lease being conditional upon the payment of the rent within a certain period, Daniel Cage, it was complained, 'hath nowe of late sought by dyvers lewd practyces' to overthrow the lease. The result of the petition is not stated,²⁷ but amongst the claims for offices at the coronation of James I in 1603 are those of Edward Earl of Oxford and Daniel Cage, each of whom claimed, as seised of the

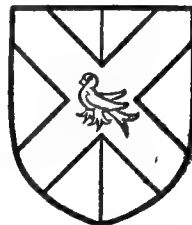

CAGE of Hormead.
Party azure and gules a saltire or with the difference of a martlet.



GREAT HORMEAD BURY: ENTRANCE FRONT

manor of Hormead, to be chamberlain to the queen. The claim was left unexamined,²⁸ owing probably to the curtailment of the coronation ceremonies on account of the Plague.²⁹

Daniel Cage died in 1634, leaving the manor of Great Hormead to his son Philip.³⁰ The latter married Elizabeth daughter of Robert Thornton, and their eldest son Robert³¹ was probably the father of Thornton Cage, who was holding the manor in 1662.³²

⁸ *Red Bk. of Exch.* (Rolls Ser.), ii, 759; *Cal. Rot. Pat.* (Rec. Com.), 231.

⁹ Assize R. Herts. 318, m. 20; *Tessa de Nevill* (Rec. Com.), 266b.

¹⁰ *Abbrev. Rot. Orig.* (Rec. Com.), i, 11.

¹¹ Assize R. 323.

¹² *Coll. Topog. et Gen.* v, 199.

¹³ Assize R. 325.

¹⁴ G.E.C. *Complete Peerage*; *Coll. Topog. et Gen.* v, 199.

¹⁵ *Cal. Pat.* 1292-1301, p. 141.

¹⁶ Chan. Inq. p.m. 24 Edw. I, no. 62.

¹⁷ *Cal. Pat.* 1292-1301, p. 253; Feet of F. Herts. 25 Edw. I, no. 340.

¹⁸ *Cal. Inq. p.m.* 1-10 Edw. III, 100;

Esch. Enr. Accts. (Exch. L.T.R.), 3 Edw. III, no. 2.

¹⁹ *Cal. Chart. R.* 1327-41, p. 123.

²⁰ See Feet of F. Div. Co. 10 Edw. III, no. 15; 16 Edw. III, no. 15; Chan. Inq. p.m. 34 Edw. III, no. 84; 40 Edw. III, no. 38; 45 Edw. III, no. 45; 20 Ric. II, no. 62; 14 Hen. IV, no. 17; 4 Hen. V, no. 53; *Cal. Pat.* 1429-36, p. 632.

²¹ *Cal. Pat.* 1467-77, p. 297; Chan. Inq. p.m. 15 Edw. IV, no. 28.

²² *Cal. Pat.* 1467-77, p. 556.

²³ G.E.C. *Complete Peerage*.

²⁴ Chan. Inq. p.m. (Ser. 2), xxviii, 68.

²⁵ Ct. of Wards Misc. Bks. dlxxviii, fol. 378; Feet of F. Div. Co. East. 2 Edw. VI; *Recov. R. Mich.* 1571, rot. 1265.

²⁶ Feet of F. Herts. Trin. 21 Eliz.; Pat. 21 Eliz. pt. v.

²⁷ Chan. Proc. (Ser. 2), bdle. 225, no. 94.

²⁸ Coronation R. Jas. I; *Cal. S. P. Dom.* 1603-10, p. 24.

²⁹ cf. Chauncy, op. cit. 136.

³⁰ Chan. Inq. p.m. (Ser. 2), cccclxxiv, 77.

³¹ *Visit. of Herts.* (Harl. Soc.), 36.

³² *Recov. R. Trin.* 14 Chas. II, rot. 103; cf. Chauncy, op. cit. 136; and pedigree in Cussans, *Hist. of Herts. Edwinstree Hund.* 66.

A HISTORY OF HERTFORDSHIRE

The matrimonial troubles of Thornton Cage form the subject of a pamphlet published in 1685.³³ In it he complains of the extravagance of his wife and her mother, who, however, laid out the grounds at Hornead Bury with great taste. As a result, probably, of their extravagance, Thornton Cage in 1680 sold the manor of Great Hornead to Bernard Turner,³⁴ who died in 1696, leaving the manor to his son John.³⁵ The latter was succeeded by his son Anthony, who was lord of the manor in 1728.³⁶ Anthony Turner appears to have conveyed the manor in 1733 to Thomas Turner,³⁷ who held it in 1737.³⁸ The descent for some time after this is obscure. In 1751 the manor had passed into the possession of Lyde Browne,³⁹ by whom it was sold in 1770 to James Haughton Langston, together with woods called Anney Wood, The Park, Eden Grove and The Frith.⁴⁰ The latter in 1792 conveyed it to Thomas Welch,⁴¹ by whom it was sold in 1810 to Colonel Edward Stables. He was killed in 1815 at Waterloo, and on his death the manor passed to his brother Colonel Henry Stables, who was the possessor in 1827.⁴² After the death of the latter the manor was bought by his cousin Robert Trotter of Crawley, by whom it was sold shortly afterwards to James White Higgins of Furnivall's Inn. The latter died in 1854, leaving the manor to his daughter Harriet wife of Archdeacon Allen.⁴³ John Higgins Allen of 48 Lensfield Road, Cambridge, is the present lord of the manor.

The manor of *REDES WELL* (*alias* Clarkes or Hornead Hall), which in later documents is described as held of the manor of Brooks in Stevenage, probably originated in the half knight's fee in Great Hornead held in 1303 by John Marshal of Laurence de Brok,⁴⁴ who also had the manor of Brooks in Stevenage.⁴⁵ Its name suggests that it was identical with the half knight's fee which William Hilton held in Great Hornead in 1428 and which was formerly held by John Redeswell.⁴⁶ It appears first described as a manor in a fine levied in 1462 by which John Clarke and Alice his wife acknowledged the right of William Pyke in the manor of Redeswell and warranted it to William and his heirs against the heirs of Alice.⁴⁷

By 1501 the manor had passed to Hugh Braban and Margaret his wife, who conveyed it to John Wynger, Bartholomew Rode, John Style and Thomas Baldry, all citizens of London, and the heirs of Bartholomew.⁴⁸ In 1521 Bartholomew Wyndout died seised of the manor of Redeswell, described in the inquisition as held of William Node as of his manor of Brooks in Stevenage by fealty and rent. Richard Wyndout, son of Bartholomew, succeeded his father.⁴⁹ Subsequently the manor passed by marriage to John Delawood, who held it by knight service in right of Katherine his wife. They were succeeded by their son Francis Delawood,⁵⁰ who in 1614 died seised of the manor of Redeswells *alias* Clarkes, held of Ralph Radcliffe as of his manor of Brooks. His heir was his grandson Francis Delawood the younger,⁵¹ and the family appears to have held the manor⁵² until it came by the will of William Delawood (dated 1694) to Abraham and Isaac Houblon.⁵³ It descended in the Houblon family⁵⁴ until a few years ago. The present lord of the manor is Mr. G. B. Oyler of Cheshunt.

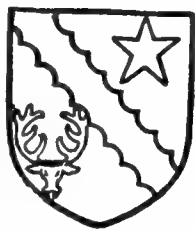

STABLES. *Gules a bend engrailed or between a mole in the chief and a hart's head caboshed in the foot both argent.*

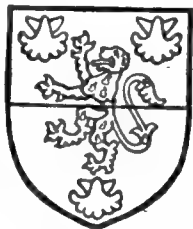

WYNDOUT. *Party fessewise gules and or a lion parted fessewise argent and azure and sprinkled with drops countercoloured between two scallops or in the chief and a scallop gules in the fess.*

The church of *ST. NICHOLAS* consists of chancel 27 ft. 6 in. by 16 ft. 6 in., nave 39 ft. 6 in. by 17 ft., north and south aisles each 9 ft. wide, west tower 14 ft. from north to south and 11 ft. from east to west, organ chamber and south porch; all the dimensions are internal. The walls are of flint rubble with stone dressings; the roofs are partly lead-covered and partly tiled.

The nave is the oldest part of the church. A north aisle with an arcade of three bays was added towards the end of the 13th century. Not long afterwards, about 1300, the south aisle was built with an arcade of at least four bays and at the same time the north arcade was lengthened westwards to correspond. About the middle of the 14th century the west tower was built and the nave shortened to a little over its original length of three bays. The upper part of the tower and the nave clearstory are of 15th-century date. In the 19th century the chancel was practically rebuilt and an organ chamber and vestry added on the south side, a south porch was built and the whole church thoroughly restored and much of the stonework renewed.

The chancel, vestry and organ chamber, with the chancel arch, are all modern.

The nave has a north arcade of three bays with arches of two chamfered orders with a label next the nave; the piers are octagonal with moulded capitals and bases. At the west end of the arcade are two semi-octagonal responds back to back, with capitals and bases to each, and the springing voussoirs of the western arch added about 1300 and taken down when the tower was built about the middle of the 14th century. The sections of the capitals vary slightly in detail. The details of the south arcade differ but slightly from those on the north. The

³³ See Misc. Tracts, B.M.

³⁴ Feet of F. Herts. Trin. 32 Chas. II; Chauncy, op. cit. 136.

³⁵ Chauncy, loc. cit.

³⁶ Salmon, *Hist. of Herts.* 310; Feet of F. Herts. Mich. 2 Geo. II.

³⁷ Feet of F. Herts. Trin. 6 & 7 Geo. II.

³⁸ Ibid. Hil. 11 Geo. II.

³⁹ Recov. R. East. 24 Geo. II, r. t. 8.

⁴⁰ Com. Pleas D. Enr. Hil. 10 Geo. III, m. 124.

⁴¹ Feet of F. Herts. Trin. 32 Geo. III.

⁴² Clutterbuck, *Hist. of Herts.* iii, 419.

⁴³ Cussans, op. cit. 68.

⁴⁴ *Feud. Aids*, ii, 431.

⁴⁵ *Cal. Inq. p.m.* 1-20 *Edw.* I, 75.

⁴⁶ *Feud. Aids*, ii, 445.

⁴⁷ Feet of F. Herts. 2 *Edw.* IV, no. 4.

⁴⁸ Ibid. Trin. 16 Hen. VII, no. 22.

⁴⁹ Chan. Inq. p.m. (Ser. 2), xxxvi, 76.

⁵⁰ Chan. Proc. (Ser. 2), bde. 264, no. 2.

⁵¹ Chan. Inq. p.m. (Ser. 2), cccvii, 5; Ct. of Wards, Feod. Surv. 17.

⁵² See Feet of F. Herts. Hil. 20 & 21 Chas. II.

⁵³ Inscription in church.

⁵⁴ Recov. R. East. 31 Geo. II, rot. 304; 10 Geo. III, rot. 59; Hil. 8 & 9 Geo. IV, rot. 289; Cussans, op. cit. 68.

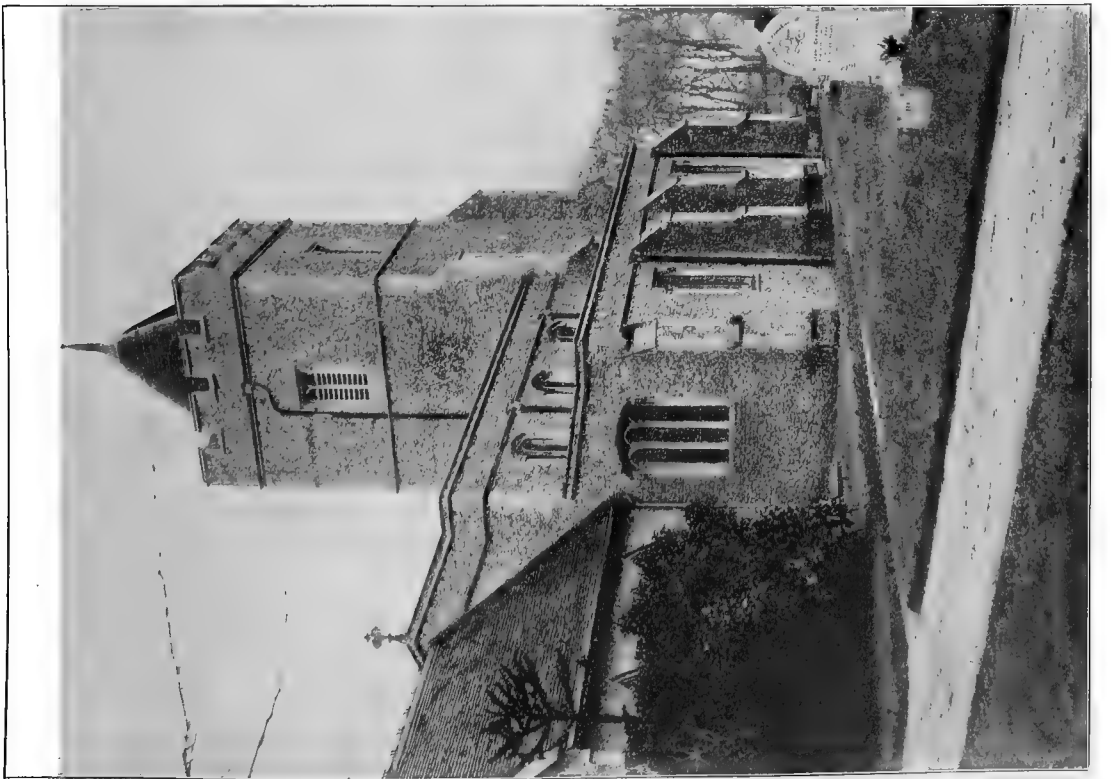
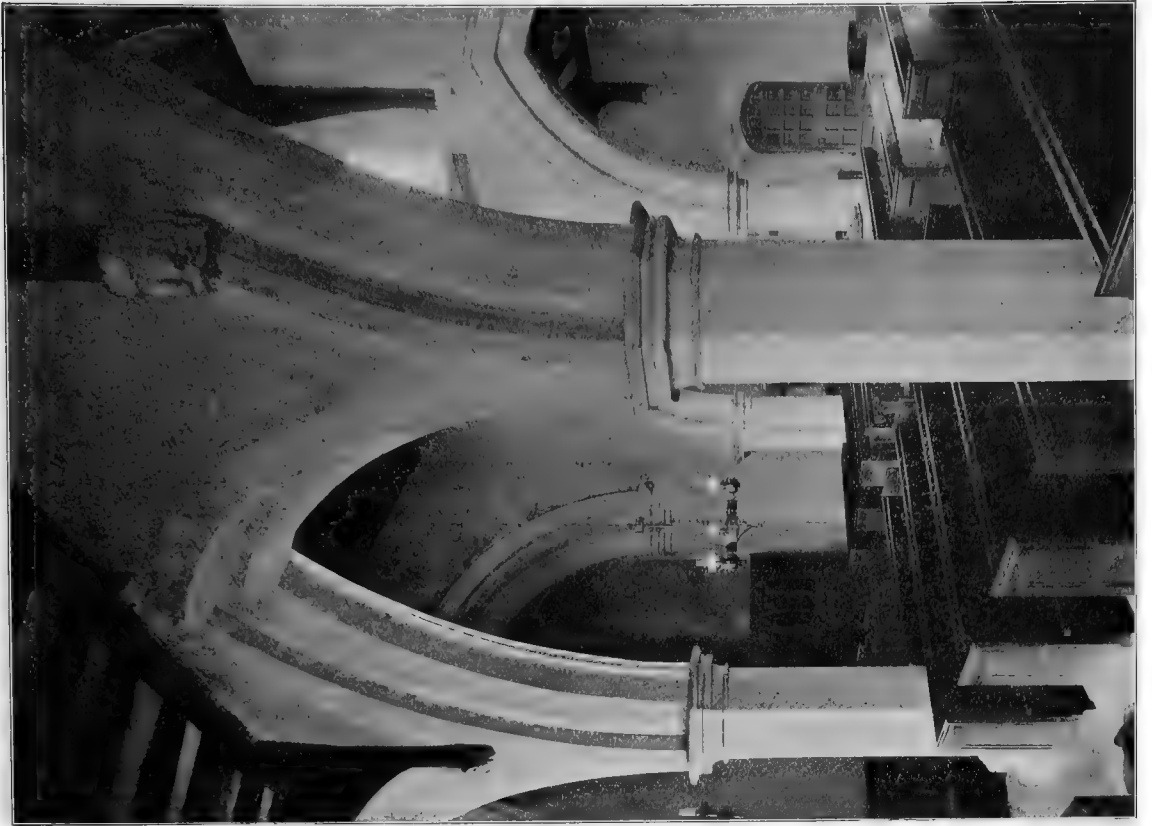

EDWINSTREE HUNDRED GREAT HORMEAD

western respond was originally a detached pier of the destroyed bay; the springing of its arch still remains against the west wall. The original east responds of both arcades consisted of a short length of walling; these have been pierced with modern arches and the old responds replaced by modern piers. The clearstory windows are each of two lights of modern stonework, only the inner jambs being old. The nave roof is of 15th-century date with moulded beams, under which are traceried brackets resting on grotesque stone corbels.

The north aisle has an east window of three cinquefoiled lights and three north windows of two lights, all of modern stonework except the inner jambs, which are original; the north doorway is also of modern stonework. At the east end of the south

recesses being about 1 ft. in depth. In the south-west angle is a blocked doorway formerly opening to the turret stair; a modern doorway for access has been inserted in the wall outside. Over the ground story is a wood ceiling of 15th-century date with moulded beams, having carved bosses at the intersections. The cornice is moulded and embattled. In the centre of the ceiling is a circular opening for the bells with carved spandrels. The west window of three lights with a traceried head is of modern stonework. In the second stage is a modern two-light window with a clock dial above it; the belfry windows are of two cinquefoiled lights under traceried heads, all of modern stonework externally.

The 12th-century font has a plain octagonal bowl with played upper and lower edges; it rests on a



HORMEAD HALL, GREAT HORMEAD, FROM THE SOUTH-WEST

aisle is a modern archway to the organ chamber. In the north wall are three two-light windows of modern stonework with old inner jambs; the south doorway has continuously moulded arch and jambs, chiefly of modern stonework. The roof over the north aisle is modern; that over the south aisle is of 15th-century date, with moulded beams and some grotesque stone corbels. The south porch is modern.

The west tower is of three stages with diagonal buttresses, embattled parapet and short tile-covered spire. The tower arch, which dates from about the middle of the 14th century, is of three splayed orders with moulded labels and head-stops; the jambs are moulded, having engaged shafts with moulded capitals and bases. The north, south and west walls of the tower are recessed on the ground story, the arched

large circular central shaft, with a smaller shaft at each angle; the shafts have neither capitals nor bases. On the north aisle wall is a brass inscription to William Delawood of London, merchant, 1696.

There are six bells: the first by Richard Keene, 1701⁵⁵; the second by C. & G. Mears, 1845; the third inscribed 'Sonora sono meo sono Deo,' 1606 (by Robert Oldfeild); the fourth by Miles Graye, 1626; the fifth and sixth by Miles Graye, 1623.

The communion plate consists of a cup, 1740, another cup, 1748, two modern silver patens and two brass almsdishes.

The registers before 1812 are as follows: (i) baptisms, burials and marriages 1538 to 1724; (ii) baptisms and burials 1725 to 1812, marriages 1725 to

⁵⁵ See article on Bell-founding in *Industries*, p. 271.

A HISTORY OF HERTFORDSHIRE

1753; (iii) and (iv) marriages 1754 to 1783 and 1784 to 1812 respectively.

A member of the Sanford family *ADVOUSON* founded the priory of St. Laurence of Blackmore in Essex before the end of the 12th century, and it was probably by the founder or one of his immediate descendants that the church of Hormead was granted to the priory.⁶⁶ After the priory had been suppressed under the bull of 1524 the rectory and advowson of Hormead were amongst its possessions⁶⁷ which were granted for the foundation of Wolsey's colleges,⁶⁸ and in the same year Wolsey received a mortmain licence to appropriate the rectory for Cardinal's College, Oxford.⁶⁹ In 1528 the Dean and canons of Cardinal's College leased the rectory and advowson of Great Hormead to Sir John Jenkinson, vicar of Hormead, and one of his parishioners for twenty-one years, stipulation being made that the dean or any canon sent to receive the rent should have 'honszome honest lodging mete and drynke good and sufficient with hey provender and litter for their horses by the space of one daye and one nyght in every yere.'⁶⁰ In 1530, after the attainder of Wolsey, the rectory of Hormead was assigned by the Crown to the college at Windsor,⁶¹ but in 1532 the Abbot and convent of Waltham Holy Cross received a grant of the advowson of the church with power to appropriate the rectory.⁶²

After the Dissolution the rectory and advowson were granted in 1543 to John Sewester,⁶³ who in 1545 conveyed them to Thomas Brand, senior, and Thomas Brand, junior.⁶⁴ They remained with the family of Brand for some years, but some arrangement seems to have been made before 1593 with regard to a division of the right of patronage. George Brand, who died in 1593, held one-third of the rectory and advowson,⁶⁵ whilst in 1609 Thomas Brand settled two-thirds of the rectory and advowson and all the mansion-house of the rectory called 'le parsonage house' on his son Thomas on the marriage of the latter.⁶⁶ The younger Thomas Brand died in 1640, leaving two-thirds of the patronage and of the rectory to his son Thomas.⁶⁷ The owner of the right of

presentation for two turns apparently sold his right to Bernard Turner, lord of the manor, in 1687.⁶⁸ The right of the latter, according to Cussans, descended to Thomas Turner, who sold it to Abraham Houblon, from whom the right of presentation was bought by the Master and fellows of St. John's College, Cambridge, before 1728.⁶⁹ The rectory apparently remained with the lords of Redeswell, for John Archer-Houblon suffered a recovery of it in 1828.⁷⁰ The other third of the advowson was vested in a branch of the Brand family as late as 1797, in which year the Hon. Thomas Brand presented,⁷¹ but it was apparently bought finally by St. John's College, Cambridge, in the gift of which the living is at the present day.⁷²

In the reign of Henry III a grant was made by John Fitz Warren, on behalf of Lora de Sanford, of a lamp to burn day and night before the cross in the church of Great Hormead and a wax candle before the altar for a mass of the Blessed Mary for the souls of Lady Loretta de Sanford and of her predecessors and heirs.⁷³

In 1694 William Delawood of *CHARITIES* London, merchant, born at Hormead Hall, the seat of his ancestors, gave £10 a year for the poor, to be distributed at Christmas by the lord of the manor of Hormead Hall and the minister and churchwardens, as recorded on a table in the church. The annuity is paid by Mr. G. B. Oyler, owner of Hormead Hall.

The Poor's Land consists of 5 acres in this parish and 5 acres in the parish of Layston. The rents, which amount to about £10 a year, are applied in the distribution of money.

Unknown donors' charities.—It is stated in the Parliamentary returns of 1786 that a donor unknown gave a rent-charge of £1 per annum for the poor; also that an annuity of £2 was given to the poor by a donor unknown.

The annuity of £1 is paid out of the parsonage by Mr. G. B. Oyler, owner of Parsonage Farm, under the title of Brand's charity, but the annuity of £2 does not appear to be received.

LITTLE HORMEAD

Little Hormead is a thinly populated parish consisting mainly of arable land¹ with little woodland. It has an area of 1,065 acres. The parish lies at an elevation of from 300 ft. to 400 ft. The soil is mixed, the subsoil chiefly clay. The chief crops are wheat, barley and beans. On the south-east of the parish is a detached part of Great Hormead parish, and again on the east of this is a small piece of Little Hormead.

The Cambridge Road passes through the western

end of the parish, parallel with the River Quin. The village lying at some distance from the river and from the main road consists of a few houses scattered along the road from Great Hormead which, after winding through the parish, leads to Furneux Pelham. On the west side of this road, and about a third of a mile south of Great Hormead Church, stands St. Mary's Church, which by reason of its proximity to the church of Great Hormead is used but occasionally. Close to St. Mary's Church is the manor-

⁶⁶ See Dugdale, *Mon.* vi, 552. The founder was either Jordan de Sanford or John de Sanford.

⁶⁷ Chan. Inq. p.m. (Ser. 2), lxxvi, 1 (Cambridge); Exch. Inq. p.m. (Ser. 2), file 309, no. 11.

⁶⁸ *L. and P. Hen. VIII*, iv (1), 1833.

⁶⁹ *Ibid.* iv (2), 2167.

⁷⁰ Aug. Off. Convent. Leases (P.R.O.), Oxon. bdle. 4.

⁷¹ *L. and P. Hen. VIII*, iv (3), 6516.

⁶⁸ *Ibid.* v, g. 766 (2); Newcourt, *Reper.* 835.

⁶⁹ *L. and P. Hen. VIII*, xviii (2), g. 327 (19).

⁷⁰ Com.Pleas D. Enr. Hil. 36 Hen. VIII, m. 2.

⁷¹ Chan. Inq. p.m. (Ser. 2), cclxxviii, 127.

⁷² *Ibid.* ccccxxxiv, 95.

⁷³ *Ibid.* dclxxvi, 69.

⁷⁴ Salmon, *Hist. of Herts.* 310.

⁷⁵ Cussans, op. cit. *Edwinstree Hund.* 70; Salmon, loc. cit. Charles Crowch,

grandson of Bernard Turner, appears as vouchee in a recovery of two parts of the advowson of the vicarage suffered in 1720 (Recov. R. Mich. 7 Geo. I, rot. 55). He probably had a term of years, for he presented in 1721 (Inst. Bks. P.R.O.; cf. advowson of Little Hormead).

⁷⁰ Recov. R. Hil. 8 & 9 Geo. IV, rot. 289.

⁷¹ *Ibid.*

⁷² See Cussans, loc. cit.

⁷³ Harl. Chart. 50 C. 17.

¹ Statistics from Bd. of Agric. (1905).



LITTLE HORMEAD CHURCH FROM THE SOUTH-WEST



LITTLE HORMEAD CHURCH : THE CHANCEL ARCH

house, Little Hornead Bury. At Stonbury Farm in the extreme south-west of the parish and at Mutford's Farm there are fragments of homestead moats. A tumulus on Bummer's Hill near the east bank of the Quin is in fairly good condition.

Ballons Farm lies a little to the south-east of the church. It is a timber-framed and plastered building of early 17th-century date with thatched roof; the house is now divided into three dwellings. The plan of the main block is rectangular and at each end is a wing projecting northwards. The chimney stacks have plain square shafts set diagonally. The original entrance was on the north side, but it has been much altered; inside the house are some wide fireplaces, one having a three-centred arch, which has been considerably altered.

One of the rectors of Little Hornead, Stephen Nye, was a theological writer of some note. He was instituted to the rectory in 1679. As the living was a small one, he read the service 'once every Lord's Day' and had 'an opportunity very seldom lacking of supplying also some neighbouring cure.' In 1712 he drew up a manuscript account of the glebe and tithes of Little Hornead, about which there had been disputes.²

Bordesdon, now represented by Bozen Green in the parish of Braughing, was returned under Edwinstree Hundred in the Survey of 1086³ and in 1386 was said to be generally assessed with the parish of Little Hornead.⁴ It is found as a separate vill in the 14th century⁵ and was probably once a hamlet of some size.

The two Horneads are not distinguished by name in the Domesday Survey. The manor of *LITTLE HORMEAD* was apparently the estate in Hornead which formed part of the lands of Count Eustace of Boulogne, of whom two Englishmen held 3 hides and 1 virgate in Hornead.⁶ The overlordship descended with the honour of Boulogne. By the beginning of the 13th century Little Hornead had come with the manor of Anstey (q.v.) into the hands of Hubert de Anstey, who in 1211 held three knights' fees of the honour of Boulogne in Anstey, Hornead and Braughing.⁷ It descended with Anstey to the family of Monchensey. In 1260 William de Monchensey granted the manor to his mother Denise and Robert le Botiller her husband,⁸ evidently by a second marriage. In 1268 Denise made a life grant of the manor to Richard le Botiller, her brother-in-law.⁹ Denise daughter and heir of William de Monchensey, who in 1290 had married Hugh de Vere,¹⁰ eventually succeeded to the manor of Little Hornead, which in

the inquisition taken at her death in 1314 is described as held of the honour of Boulogne.¹¹ Aymer de Valence Earl of Pembroke, son of Joan de Valence daughter of Warin de Monchensey, father of William,¹² was the nearest heir. After the death of Aymer, Richard de Wynneferthing, clerk, who had been enfeoffed by him of the manor of Little Hornead without a licence in mortmain, surrendered it to the king in 1325. The king then granted it to Mary de St. Paul, widow of Aymer, with remainder to Aymer's heir, Laurence son of John de Hastings, and Eleanor daughter of Hugh le Despenser, to whom he was betrothed.¹³ In 1376, however, the reversion of the manor after the death of Mary de St. Paul was granted to the Abbot and convent of St. Mary of Graces by the Tower of London,¹⁴ the grant being confirmed by the pope in 1403,¹⁵ by Henry VI in 1433¹⁶ and by Edward IV in 1461.¹⁷

The monastery continued to hold the manor of Little Hornead until the Dissolution. In August 1540 it was granted to Thomas Barbour of London,¹⁸ who in November of the same year received licence to alienate it to Thomas Lord Audley of Walden, then Chancellor.¹⁹ Lord Audley died seised of the manor in 1544, leaving two daughters, Mary and Margaret, both under age.²⁰ On account of their minority Lord Audley's lands were in the hands of the king, who in 1545 granted to Sir Anthony Denny an annuity of £50 out of Little Hornead and other manors with the wardship and marriage of Margaret Audley.²¹ Margaret married (secondly) Thomas Howard fourth Duke of Norfolk. He survived her and held the manor for life, the reversion belonging to their son (Lord) Thomas Howard. In 1572, by reason of the attainder of the duke for high treason, his property was in the hands of the queen.²² In 1592 Lord Thomas Howard sold the manor of Little Hornead, which had been restored to him, to Edward Newport.²³ It descended with the manor of Furneux Pelham (q.v.) until 1806, when John Calvert sold it to Richard Wyman.²⁴ Wyman's executors sold it to William Williamson, on whose death in 1839 it passed to his grandson J. Williamson Leader of Buntingford. He left it to his sister Miss Leader, after whose death it was bought in 1909 by Mrs. William Thomas Rayment Patten, who is now lady of the manor.²⁵

The descent of the manor of *STONBURY* is very obscure. It has been identified with the Domesday Stanes held by Peter de Valognes in 1086. It first appears under the name of Stonbury in the middle of the 13th century.²⁶ In 1286 Walter de Nevill died seised of a manor in Little Hornead held of the manor of Boxe in Walkern, Broadwater Hundred.²⁷ He left

² *Dict. Nat. Biog.*

³ *V.C.H. Herts.* i, 322a, 324b, 331a.

⁴ See return of jury in 1386 quoted by Cussans, *Hist. of Herts. Edwinstree Hund.* 75; Lay Subs. R. bdlie. 120, no. 8 (1 Edw. II).

⁵ Assize R. 323, m. 44 (6 & 7 Edw. I).

⁶ *V.C.H. Herts.* i, 322a.

⁷ *Red Bk. of Exch.* (Rolls Ser.), ii, 578.

⁸ Feet of F. Div. Co. 44 Hen. III, no. 56.

⁹ Ibid. 52 Hen. III, no. 14. For the Botillers see Mecsden.

¹⁰ *Cal. Pat.* 1281-92, p. 376.

¹¹ *Cal. Inq. p.m.* 1-9 Edw. II, 268-9.

¹² *Matt. Paris, Chron. Maj.* (Rolls Ser.), v, 504.

¹³ *Cal. Pat.* 1324-7, pp. 108, 153; Anct. D. (P.R.O.), C 1658. (This deed is dated 19 Edw. I for 19 Edw. II in the Calendar.)

¹⁴ *Pat.* 50 Edw. III, pt. ii, m. 16; *Cal. Pat.* 1429-36, p. 415.

¹⁵ *Cal. Papal Letters*, v, 547.

¹⁶ *Cal. Pat.* 1429-36, p. 415.

¹⁷ *Ibid.* 1461-7, p. 162.

¹⁸ *L. and P. Hen. VIII*, xv, g. 1027 (6). Margaret Countess of Kent appears to have had a lease of the manor, since payments were made by the Council in 1541 and 1543 as compensation for a three years' term (*ibid.* xvi, 745, fol. 39; xviii [2], 231, p. 123).

¹⁹ *Ibid.* xvi, g. 305 (12).

²⁰ *Chan. Inq. p.m.* (Ser. 2), lxxxvi, 100.

²¹ *L. and P. Hen. VIII*, xx (1), g. 465 (88).

²² *Chan. Inq. p.m.* (Ser. 2), clxi, 79.

²³ Feet of F. Herts. Mich. 34 & 35 Eliz.

²⁴ Clutterbuck, *Hist. of Herts.* iii, 424.

²⁵ Cussans, *op. cit. Edwinstree Hund.* 75; inform. from Mr. W. T. R. Patten.

²⁶ Feet of F. Herts. 26 Edw. III, no. 391.

²⁷ *Cal. Inq. p.m.* 1-19 Edw. I, 356. Boxe had also been held by Peter de Valognes in 1086, which accounts for this mesne lordship being attached to it. The overlordship descended with the Valognes family and their successors the Benstedes; see *Cal. Inq. p.m.* 10-20 Edw. II, 285, 286.

A HISTORY OF HERTFORDSHIRE

a son John, who died in 1313 and was succeeded by his son Walter.²⁸ The latter was holding the manor in Little Hornead in 1325 by knight service.²⁹ He died in 1329, leaving a daughter Agnes, who married Thomas Fytlyng.³⁰ In 1352 a settlement was made with regard to the manor of Stonbury, which was held for life by Katherine formerly wife of Walter Nevill. It was arranged by fine that the reversion of the manor, which was said to belong to Reginald de Cobham after the death of Katherine, should go to Thomas de Fytlyng and Agnes his wife. In case of failure of heirs on the part of Thomas and Agnes the manor was to revert to the heirs of Reginald.³¹ In 1408 Reginald son and heir of Reginald Cobham granted the manor of Stonbury to Thomas Colepeper and others who were probably acting as trustees.³² There is no evidence of the descent during the next hundred years from this date, but the manor appears to have passed by 1513 to the family of Bolnes.³³ In that year it was the subject of a fine between Agnes Bolnes, widow, Robert Bolnes and others on the one part and Katherine Bolnes, widow, on the other.³⁴ A member of the same family probably held the manor in 1561, in which year Thomas Bolnes was a freeholder in Little Hornead.³⁵ In 1612 William Bownest died seised of the manor of Stonbury, which

no spot in Hornead comparable to it, and indeed very few in the County, especially if we esteem Retirement, as the Owners for some Generations have done.³⁶

There is no trace of the descent of the reputed manor of *BALLONS* until the 17th century, when it belonged to the Provost and fellows of King's College, Cambridge, to whom in 1622 a recommendation was made for a lease to Lady Lewin.³⁷ The site of the manor appears to have lain near the church and manor-house of Little Hornead and somewhat to the south-east of them, where the estate known as Ballons is situated at the present day.

The church of *ST. MARY* consists *CHURCH* of chancel 24 ft. by 12 ft. 6 in., nave 27 ft. 6 in. by 15 ft. 3 in., south porch and wooden bell-turret on the west end of the nave; all dimensions are internal. The walls are of flint rubble with stone dressings; the nave walls are covered with cement; the roofs are tiled. The chancel inclines slightly to the north.

The nave dates from about 1140-50; the chancel appears to have been entirely rebuilt early in the 13th century. In the 17th century a buttress was built against the south wall of the nave and in the 18th century the brick south porch was added.

In 1888 the church was restored and the chancel shortened by rebuilding the east wall a few feet further west.

The three lancet windows in the east wall of the chancel are modern. There is no opening in the north wall. In the south wall are two 13th-century lancets; they differ slightly in their heights and external widths, and the westernmost, which is probably a little later in date, has its inner jambs much more widely splayed than the other. Between the windows is a modern doorway in cement. In the western end of the

chancel is a 15th-century window of two cinquefoiled lights under a square head. At the east end of the south wall and partly covered by the modern east wall is a plain pointed piscina with splayed edges; it may be of 15th-century date. The chancel arch is of 12th-century date, with round arch considerably flattened. The arch is of two orders, the inner one square, the outer with a large bead. The jambs are square with engaged circular shafts, scalloped capitals and moulded bases. The roof may be of 18th-century date.

In the north wall of the nave is a 12th-century round-headed window placed high up in the wall. The blocked north doorway is also of 12th-century date; it has a round arch with mouldings similar to the chancel arch. The tympanum is of cement; the jambs have circular shafts with scalloped capitals and moulded bases much decayed. The doorway still retains the original plank door of oak covered with

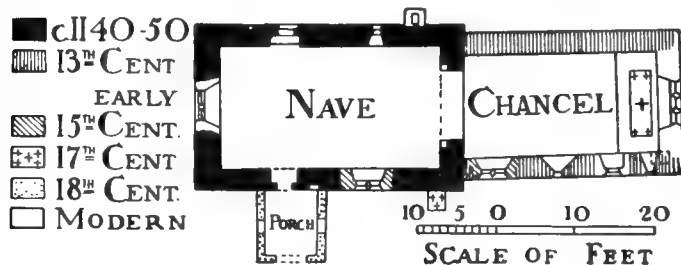

PLAN OF LITTLE HORNEAD CHURCH

is described as held of Francis Delawood as of his manor of Hornead Redeswell in Great Hornead by suit of court.³⁶ The manor remained with the descendants of William Bownest,³⁷ one of whom, William Bownest, was lord of the manor in 1725.³⁸ By 1758, however, it had come into the possession of Jacob Houblon, who in that year settled it on his son Jacob,³⁹ and it was held by John Archer-Houblon in 1826⁴⁰ and has apparently since descended with the manor of Redeswell in Great Hornead.⁴¹

Salmon, writing in 1728, says of the manor-house of Stonbury: 'Stonebury hath been also a Manor, but sunk for want of Tenants. It was probably the Residence of some great Man before and after the Conquest. If we consider the beautiful Situation of it upon a rising Ground, towards the South East Sun, well wooded and watered, the Land all enclosed and entire, intermixed with none, between and at a proper Distance from both of the great Roads, we may admit

²⁸ *Cal. Inq. p.m.* 1-9 *Edw. II*, 252.

²⁹ *Ibid.* 10-20 *Edw. II*, 286.

³⁰ See King's Walden in Hitchin Hund. *V.C.H. Herts.* iii, 35.

³¹ Feet of F. Herts. 26 *Edw. III*, no. 391.

³² Close, 10 *Hen. IV*, m. 32.

³³ Probably the name was an older form of Bownest.

³⁴ Feet of F. Herts. Hil. 5 *Hen. VIII*.

³⁵ See list of freeholders cited in Cussans, op. cit. *Edwinstree Hund.* 9.

³⁶ *Chan. Inq. p.m.* (Ser. 2), cccxxxix, 157.

³⁷ See *Recov. R. Mich.* 20 *Chas. II*, rot. 179; *East.* 7 *Geo. I*, rot. 23.

³⁸ *Ibid.* *East.* 11 *Geo. I*, rot. 297.

³⁹ *Com. Pleas D. Enr. East.* 31 *Geo. II*, m. 124.

⁴⁰ *Recov. R. Hil.* 6 & 7 *Geo. IV*, rot. 203.

⁴¹ *Ibid.* Hil. 8 & 9 *Geo. IV*, rot. 289.

⁴² Salmon, *Hist. of Herts.* 311.

⁴³ *Cal. S. P. Dom.* 1619-23, p. 409. See Chauncy, op. cit. p. 311. Biggin, which also belonged to the college, had been the endowment of the hospital of St. Mary Biggin in Anstey.



LITTLE HORMEAD CHURCH : BLOCKED NORTH DOORWAY

fine 12th-century ironwork. It is of two square panels in height, each panel filled with interlacing work formed of strip iron, with tendrils in the spaces. The designs differ slightly in detail and in the lower panel is the figure of a bird; on each side is a vertical border with tendrils and above are fragments of similar ornament. Portions of the ironwork have gone, but most of it remains and is being protected as far as possible from the weather. In the south wall is a window of 15th-century date of two cinque-foiled lights with tracery under a square head. The wall east of this may contain another blocked window, as there are indications of a disturbance in the plaster. The south doorway is of 12th-century date, with plain round arch and square jambs with splayed impost. The two-light west window is modern; above it in the gable is a circular opening with quatrefoil cusping. The nave roof retains some old plain tie-beams and portions of brackets beneath them. Over the chancel arch are the royal arms of Charles II, dated MDC LX. The south porch is a very plain structure of brick erected in the 18th century. In the north-east angle is a plain round-headed stoup with splayed edges. The wooden bell-turret is modern.

The font is of oolite and dates from the early part of the 14th century. It has an octagonal bowl moulded underneath; on each face are circular cusped panels containing roses or leaf ornament alternating with arched panels filled with tracery, that on the east face containing a fleur de lis.

There are two bells: one, now on the floor of the church, is inscribed 'Sancta Margareta ora pro nobis'; it is undated. The other bell is in the belfry, and bears neither date nor inscription.

The communion plate is used at Great Hormead Church and has already been described.

The registers before 1812 are as follows: (i) baptisms, burials and marriages 1588 to 1679; (ii) baptisms and burials 1679 to 1812, marriages 1679 to 1753; (iii) marriages 1754 to 1811.

The advowson as a general rule *ADVOWSON* was held with the manor.⁴⁴ It was, however, excepted from the life grant of the manor made by Denise de Monchensey to Richard le Botiller in 1268,⁴⁵ and in 1517 presentation was made by Robert Shirton and others, in 1555 by John Gibbs and others, in 1646 by Katherine Young, in 1678 by Roger Woodcock and Stephen Broughton, and in 1719 by Charles Crowch,⁴⁶ none of whom, apparently, held the manor. By 1730 the advowson had been bought by St. John's College, Cambridge.⁴⁷ In 1886 the rectory of Little Hormead was amalgamated with the living of Great Hormead by Order in Council. It is in the gift of St. John's College, Cambridge, at the present day.

In 1665 Pierce Powel by his will *CHARITIES* devised an annuity of 20s., whereof he willed 15s. to be given to the poor and 5s. for keeping his grave covered with turf.

The Town Acre.—In an old register of the parish, under date 1713, it is stated that there is an acre of arable land lying in Jeffries' Field given for the use of the poor, the rent issuing therefrom to be given at the communion table in the church on the Sunday after Michaelmas Day in every year. The land is let at 10s. a year, and the rent, less tithe, is accumulated and applied from time to time in the distribution of bread.

In 1824 John Wall Porter, by his will proved in the P.C.C. 21 January, directed his residuary estate to be invested in consols and the dividends to be applied at Midsummer and Christmas in the distribution of bread and clothing among poor and needy persons, inhabitants of the parish, with power to apply £10 a year in putting out a poor boy apprentice to any trade or business. The trust fund amounted to £1,932 18s. 11d. consols, producing £48 6s. 4d. yearly, which is administered under the provisions of a scheme of 24 May 1881. By an order of the Charity Commissioners of 12 July 1904 the sum of £400 consols has been set aside as an educational foundation.

LAYSTON

Leofstanechirche (xii cent.); Lestoncherche (xiv cent.); Leyston (xv cent.).

At the time of the Domesday Survey the area now comprised by the parish of Layston appears under the names of Alswick, Ichetone and Alfladewick. In 1086 Alswick probably already had a church of its own. The building of another church a little to the east of Ermine Street at some date before the middle of the 12th century seems to have made Alfladewick an ecclesiastical parish (to which Alswick was afterwards subordinated as a chapelry) and to have obtained for it the alternative name of Lestanchurch.¹ In 1341 the name of the parish is recorded as 'Lestanchurch called Alfladewyk.'² Gradually the earlier name was entirely superseded by the other, and Lestanchurch corrupted into Layston remained the name of the parish.³

The parish of Layston now contains 1,433 acres, having been diminished by the Divided Parishes Act of March 1883, under which detached portions of the parish were transferred to Wyddial, Aspenden and Throcking. It consists chiefly of arable land. About one-quarter only is permanent grass and there is very little woodland.⁴

The River Rib flows through the parish, entering it in the north-west, and for a short distance forms its western boundary. In the valley of the Rib the land averages 300 ft. above the ordnance datum, rising in the east to a height of 407 ft. Ermine Street forms the western boundary of Layston, except for a short distance where the boundary line makes a detour to the west and follows the River Rib. At the point where Ermine Street crosses the river it is joined by the road from Great Hormead, which,

⁴⁴ See references under manor.

⁴⁵ Feet of F. Div. Co. 52 Hen. III, no. 14.

⁴⁶ See Cussans, op. cit. p. 78.

⁴⁷ *Ibid.*; see Inst. Bks. (P.R.O.).

¹ It may be suggested that the original church at Alswick was of timber and the masonry church of Alfladewick therefore became known in distinction as the stone church.

² *Inq. Nonarum* (Rec. Com.), 432.

³ See also above under account of hundred.

⁴ Statistics from Bd. of Agric. (1905).

A HISTORY OF HERTFORDSHIRE

after crossing Ermine Street, runs north-west to join the Great North Road at Baldock. At the junction of these two roads is situated the town of Buntingford, which extends into the four parishes of Layston, Throcking, Aspenden and Wyddial.

The older settlement in the parish lay near St. Bartholomew's Church, which stands about half a mile east of Ermine Street alone in the fields,⁵ almost hidden by the thick trees which surround it.

Records of Buntingford are found in the early 13th century.⁶ It was described as a hamlet in 1288.⁷ In 1292 there was a chapel there, which stood where the present chapel of St. Peter stands, on the west side of Ermine Street, north of the point where it crosses the river. The rector of Aspenden is said to have built an oratory near the king's highway about 1333. Five years later there was complaint that this was an inconvenience to travellers who passed through the town on foot in winter time, and the oratory was

the lord of the manor, Elizabeth de Burgh, received licence to transfer her market to the king's highway in Buntingford, to be held on Friday in the main road by the chapel of St. John and in the two roads which crossed that road east and west. She received also the grant of a fair to be held in the same place every year on the day and morrow of the Invention of the Holy Cross.¹¹

In 1367 Lionel Duke of Clarence, then holding the manor of Pope's Hall by inheritance, obtained a revocation of the grant of the market and fair at Buntingford, on the ground that they were harmful to his manor of Standon, and at the same time obtained a grant of a market and fair to be held at Standon.¹² The people of Buntingford, however, protested against the revocation of the grant, and claimed that the market and fair had been granted to them by Elizabeth de Burgh, and they petitioned against their removal.¹³ Accordingly the king granted them the

right to hold a market in Buntingford every Saturday and a fair there every year on the day and morrow of the Apostles Peter and Paul.¹⁴ This grant was confirmed to the lords and tenants of Buntingford by Richard II in 1378,¹⁵ but in spite of this in 1385 Richard gave the dues from the market and fair of Buntingford to Thomas Stout, groom of the buttery.¹⁶ The people of Buntingford again petitioned the king, urging their rights, and in 1387 the grant to Thomas Stout was revoked.¹⁷ The market and fair were confirmed to the inhabitants of Buntingford by Henry IV¹⁸ and

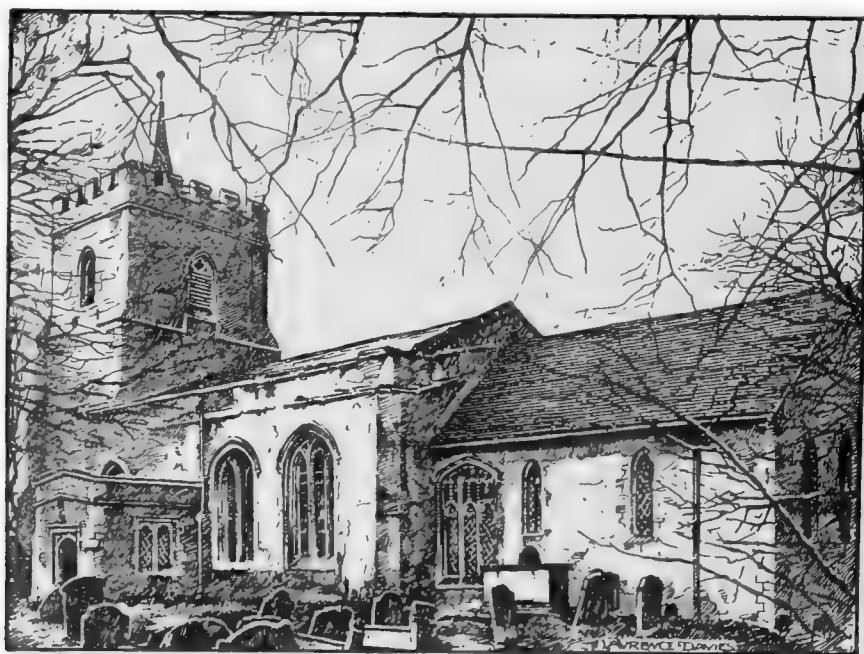

LAYSTON CHURCH FROM THE SOUTH-EAST

taken into the king's hands. It was found by inquisition, however, that it was to the benefit of the town.⁸ Buntingford must have been growing rapidly at this time, and as a centre for trade it had become more important than the neighbouring villages. From 1252 a market had been held every Friday at New Chipping,⁹ which lies on Ermine Street, only half a mile north of Buntingford. This market was attached to the manor of Pope's Hall in Buckland (q.v.). The manor included lands in Buntingford,¹⁰ and in 1360

Henry V.¹⁹ In 1542 a fresh grant was made by Henry VIII, when Thomas Audley, lord of the manor of Corneybury, the tenants of that manor and the inhabitants of the town of Buntingford received licence to hold a market in Buntingford every Monday and two annual fairs there on the day and morrow of SS. Peter and Paul and on the day and morrow of St. Andrew.²⁰ John Crouch, lord of the manor of Corneybury, who died in January 1605-6, bequeathed 20s. a year from his stalls in

⁵ Clutterbuck says that at the beginning of the 19th century it was possible to trace the foundation of houses which had once stood near the church.

⁶ Anct. D. (P.R.O.), A 1027, 1109.

⁷ Ibid. B 813.

⁸ Chan. Inq. p.m. Misc. file 135, no. 3; *Cal. Close*, 13;--9, p. 565. The description suggests that it is the above-mentioned chapel that is referred to.

The chapel, however, was built as early as 1292 (see Adwovson).

⁹ See *Cal. Chart. R.* 1226-57, p. 404.

¹⁰ See below for the fee of Osbern Bishop of Bayeux in Layston.

¹¹ Chart. R. 34 & 35 Edw. III, m. 6, no. 22; *Abbrev. Rot. Orig.* (Rec. Com.), ii, 262.

¹² Chart. R. 41 Edw. III, m. 2, no. 7; *Abbrev. Rot. Orig.* (Rec. Com.), ii, 293.

¹³ Plac. in Canc. file 4, no. 25.

¹⁴ Chart. R. 41 Edw. III, m. 2 no. 5.

¹⁵ *Cal. Pat.* 1377-81, p. 283.

¹⁶ Ibid. 1385-9, pp. 22, 39.

¹⁷ Ibid. p. 287.

¹⁸ Ibid. 1408-13, p. 293.

¹⁹ Ibid. 1413-16, p. 173.

²⁰ *L. and P. Hen. VIII*, xvii, g. 137 (4).

Buntingford market-place for the repair of the highways and of Corney Bridge²¹ and in 1738 the tolls of Buntingford market are again mentioned as attached to the manor of Corneybury,²² but this seems to be the last reference to a market being held in Buntingford. One fair is still held there every year on St. Peter's Day, 29 June.²³

The justices of the peace for Hertfordshire were holding sessions at Buntingford in 1631,²⁴ and there was a house of correction there as early as 1638,²⁵ which remained in use until the beginning of the 19th century.²⁶ A small brick lock-up probably of 18th-century date stands on the road to Layston Church. Buntingford is now the head of a petty sessional district consisting of parts of the hundreds of Edwinstree, Odsey and Braughing. In 1835 it became the union town for the district, the work-house being built in 1836.

The town of Buntingford begins north of the bridge across the Rib and extends for about half a mile up the ascent of Ermine Street. At the south end of the town Ermine Street broadens out into Market Hill. There are a number of old houses in High Street, Buntingford. Beginning at the south end, on the west side, adjoining the chapel of St. Peter, is Ward's Hospital, founded and built by Seth Ward, Bishop of Salisbury, in 1684. The buildings form three sides of a quadrangle, being open on the east side next the street. They are of two stories and are built of brick with rusticated quoins and dressings of Portland stone. A

wooden cornice with modillions and carved moulding is carried round the building. The roofs are tiled and the wing gables are hipped. The central part of the east face of the main block projects slightly and has a pediment with the modillion cornice carried round. Underneath is the principal doorway, of stone with moulded architrave and cornice with carved brackets, over which is a broken pediment with a shield containing the arms of the founder. Over the door is an inscription commemorating the foundation of the hospital. The buildings consist of eight separate dwellings, each having two rooms on the ground floor and two on the upper floor. The doorways to these dwellings have shouldered stone architraves with small moulded cornices above.

Further up the street, beyond the Market Hill, are

two dwellings, formerly the Angel Inn, with late 17th-century plastered fronts, tiled roofs and plain brick chimneys. The ground story has rusticated quoins and an entrance door with moulded and rusticated jambs and moulded pediment above. The upper story projects on a plain coved cornice with foliated brackets at intervals; the upper story is ornamented with flush plaster panels filled with combed work, much worn. At the north end of the house is a large gateway to the yard.

Another house, now partly a butcher's shop, has a plain plastered front, part of which has an overhanging upper story; the roofs are tiled. Adjoining it is a large gateway of late 16th-century date, with low three-centred wooden arches with carved spandrels. A rain-water head bears the date 1741, but the house itself is older. A house nearly opposite the George and Dragon Hotel has a plain plastered front with overhanging upper story; the roofs are tiled. The adjoining gateway has a gable over; it is probably



WARD'S HOSPITAL, BUNTINGFORD, FROM THE EAST

of early 17th-century date. The fronts of the adjoining houses have their original gables, but the facings have been modernized.

The Clock Turret, which is built over a yard entrance next a stationer's shop, has modern facing of wood and plaster, but the main timbers are old and are said to date from the 16th century. A house next the Globe Inn probably belongs to the latter part of the 17th century; it has a plastered front with shallow bay window. Beside it is a low gateway, over which is a small oriel window. Over the doorway is a wooden pediment on brackets. The White Hart Inn²⁷ has been much modernized, but the north gable is of early 17th-century date. It is of timber and plaster and the upper story overhangs. The Cock Inn has a timber and plastered

²¹ P.C.C. 22 Stafford.

²² Ibid. 354 Trenley.

²³ East Herts. Arch. Soc. Trans. ii, 1.

²⁴ Cal. S. P. Dom. 1631-3, p. 18; see

ibid. 1633-4, pp. 232, 305; 1637, p. 272; 1625-49, p. 583; Sess. R. (Herts. Co. Rec.), ii, 180, 289, 300, 347, 352.

²⁵ Cal. S. P. Dom. 1625-49, p. 583.

²⁶ Sess. R. (Herts. Co. Rec.), ii, 82, 90, 133, 165, 214, 233, 290, 344, 413, 418.

²⁷ It was held by John Bownest in 1615 (Chan. Inq. p.m. [Ser. 2], cccclvii, 77).

A HISTORY OF HERTFORDSHIRE

front and overhanging upper story ; it is of 17th-century date.

There are several cottages at the north end of High Street, on the west side, of late 16th and early 17th-century date ; they are chiefly of timber framing plastered, with portions weather-boarded.

On the east side of High Street, at the south end, in a yard behind a china shop, is a two-storied building of timber and plaster with tiled roof ; it is probably of late 16th-century date and is in a poor state of repair. The wooden doorway has a moulded four-centred arch under a square head. There are some good plain roof trusses. The oak mullioned window frames with diamond quarries are original.

The Court, originally the Buntingford Grammar School, founded about 1625, is now a private house. The building is L-shaped and is probably of early 17th-century date. The wing running north and south is the old school building and originally consisted of one room of one story ; a modern floor has been inserted and attic windows added and the front considerably modernized. The front is plastered and the entrance doorway has a semicircular arch with shallow pediment over ; the jambs are rusticated. On the north gable is a chimney stack with two octagonal shafts. Some of the windows have the original plastered brick mullions and transoms ; some plain old queen-post roof trusses still remain. The north wing is a plain plastered building of 18th-century date. The property was sold in 1902, after the failure of the school, and the endowments were used to found a technical school opened in 1903 in Baldock Lane.

A house next the George and Dragon Hotel is a plain timber and plaster building with overhanging upper story and tiled roof. The George and Dragon Hotel has a modern front, but the interior is probably of 17th-century date. On the front is an elaborate wrought-iron sign-bracket of early 18th-century date.

Towards the northern end of High Street, on the east side, is a cottage, now divided into two dwellings, which may be of early 16th-century date. It is a rectangular building of two stories with a plain central chimney ; the walls are of timber framing with plaster between the timbers. In the centre of the front is a blocked doorway of oak with three-centred arch ; the upper story projects on the ends of the floor joists. The windows with diamond quarries are original.

The boys' elementary school at Newtown was built in 1845 and the Adams Memorial School for girls and infants in 1879. Buntingford Congregational Chapel was founded in 1776.²⁸ Hope's Chapel in Farrington Yard, High Street, belongs to the Particular Baptists.

The railway station of Buntingford is on the west side of Ermine Street, about half a mile south of the bridge across the Rib. It is a terminal station on the Ware and Buntingford branch of the Great Eastern railway.

The house called Littlecourt which stands on the east bank of the Rib, on the north side of the Causeway, is on the site of a house built at the end of the 16th century by John Gyll.³⁰ By will proved in 1600 John Gyll left this house to his wife Joan, with the provision that his younger son John Gyll was to have the use of it during her life as her farmer and that after her death he was to occupy it for seven years.³¹ John's elder son Sir George Gyll died seized of it in 1619.³² His son John³³ died without issue in 1651,³⁴ when Littlecourt was probably sold. It was afterwards acquired by Bernard Turner, who died in 1696, and it descended through his son Thomas to Anne Turner, who took it in marriage to Thomas Crouch of Layston.³⁵ Littlecourt passed from the Crouches about 1726 and finally came to Viscount Falkland, who sold it in 1760 to Butler Chauncy, son of the historian.³⁶ After his death in 1766 the estate passed through many hands until it finally became the property of Captain Henry Harman Young in 1819. Captain Young pulled the old house down. On his death he left the estate to his two daughters, Matilda wife of John Dendy Pilcher and Mary Heathfield, wife of Andrew Walls.³⁷ Littlecourt has recently been bought and is now occupied by Mr. Pinckney.

Sir Frederick Abbott (1805-92), major-general in the Royal (late Bengal) Engineers, was born at Littlecourt in 1805. He had a distinguished Indian career, taking part in the forcing of the Khaibar Pass and in the occupation of Bengal. For some years he was superintending engineer of the North-West Provinces and was in charge of the military bridging establishment. He retired in 1847 and was appointed lieutenant-governor of the military college of East India, which was closed in 1861.³⁸

Beauchamps stands on a moated site about 1 mile north-east of the church ; it is now a farmhouse. Three arms of the moat are wet. The house is E-shaped on plan, and was originally built of timber-framing covered with plaster. The wings consist of two stories, the central part of one only. The roofs are tiled ; the wings have plain gables, and at each end of the central block is a brick chimney stack of three square shafts, the central shaft being larger than the flanking ones. The front is of modern brickwork, but the house itself dates from the early part of the 17th century. The house contains some 17th-century oak panelling and a panelled door with carving.

Alswick Hall, the old manor-house, now a farm, and the site of the chapel of Alswick are situated about 1 mile east of Buntingford. The hall stands on a moated site, but only a small part of the moat remains on the west side. The house, now divided into two dwellings, is of two stories. It is T-shaped on plan, the south arm of the cross being much shorter than the north ; the east wing forms the vertical portion of the cross. The walls are timber-framed and plastered, with foundations of thin bricks ; the roofs are tiled. The house is of early 17th-century date.

²⁸ The 'George' is mentioned in 1605 (Chan. Inq. p.m. [Ser. 2], ccxciv, 18). Other names of inns are the 'Bell,' mentioned in 1545 (*L. and P. Hen. VIII*, xx [1], p. 681), the 'Chekere of the Hoop' of an earlier date (Early Chan. Proc. bde. 11, no. 533) and the 'Falcon of the Woop,' i.e. the Falcon on the

hoop or barrel (Ct. of Req. bde. 77, no. 48).

²⁹ Conventicles were held in the house of a family called Gates in 1675 and later (*Sess. R. [Herts. Co. Rec.]*, i, 257, 319, 320, 331, 342).

³⁰ P.C.C. 60 Wallopp.

³¹ Ibid.

³² Chan. Inq. p.m. (Ser. 2), ccccvii, 95.

³³ Ibid.

³⁴ Cussans, *Hist. of Herts. Edwinstree Hund.* 82.

³⁵ Ibid.

³⁶ Ibid.

³⁷ Ibid.

³⁸ *Dict. Nat. Biog. Supplement.*



BUNTINGFORD : THE COURT, ORIGINALLY THE GRAMMAR SCHOOL



BUNTINGFORD : VIEW IN THE HIGH STREET

The main block, which faces west, is 71 ft. 6 in. long, exclusive of a lean-to at the north end, in which is a modern stair; the width is 17 ft.³⁹ The doorway is nearly central and opens into a modern passage leading to a doorway on the east front; this passage, which is not now a through passage, occupies the position of the former screens. On the south side is the stone-paved hall, with a wide seated fireplace on the east side; beyond is the parlour, also with a wide fireplace, partly blocked. On the north side of the entrance is a large kitchen with a wide fireplace at the north end. A short passage from the hall leads to the east wing, which contains the old brew-house, &c.; a small inclosed staircase projecting in the angle between the east wing and the shorter arm of the cross is entered from this passage. The ends of the main block, east wing and stair inclosure are gabled. The brick chimney stacks have groups of plain square shafts set diagonally; the windows have plain wooden mullions and frames and appear to be of 17th-century date. The fireplace in the hall has a three-centred arch; two of the rooms on the upper floor have fireplaces with four-centred moulded arches. In several of the rooms is panelling of 17th-century date and also some of the early 18th century, bolection moulded; some of the panels over the fireplaces inclose old oil paintings.

Layston House, to the south of the village, is the residence of Mrs. A. E. Tollemache.

In the south of the parish is Hailey Hill (Heylee, xiii cent.), which gave its name to a family holding lands in the parish in the 13th and 14th centuries.⁴⁰ Further east is the farm called Owles, a name which seems to be a phonetic rendering of the first syllable of Alswick. The house has been rebuilt and no ancient features remain.

In 1623 there is record of a house called Bolton Hall in Layston, which at that date was sold by William Wood of 'Thrist,' co. Kent, surgeon, to Benjamin Henshawe of London.⁴¹ On the south it abutted on Baldock Lane and on the east on the way leading from the Bell Inn to Baldock Lane.

Seth Ward (1617-89), the founder of Ward's Hospital, was born at Aspenden in 1617 and was educated at the grammar school in Buntingford. He was expelled from Cambridge for contributing to a book against the Solemn League and Covenant, and he then returned to his native place and was tutor for some years to the sons of Ralph Freeman of Aspenden Hall. In 1649 he became a professor at Oxford and was one of the original members of the Royal Society. He was made Bishop of Oxford in

1662 and in 1667 was translated to Salisbury. He built the almshouses in Buntingford five years before his death in 1689.⁴²

Another bishop who was connected by birth with Buntingford is James Henry Monk (1784-1851), who was born there in 1784. In 1809 Monk became Regius Professor of Greek at Cambridge. He was appointed Dean of Gloucester in 1822 and in 1830 became Bishop of Gloucester.⁴³

Sir John Watts, son of Thomas Watts of Buntingford, was a famous merchant and shipowner in the 16th century. He owned a ship that fought against the Spanish Armada and served on her himself. In 1590 he successfully engaged with Spanish ships near Madrid. To the King of Spain he was described as one of 'the greatest

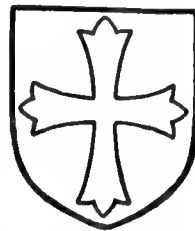

WARD. Azure a cross paty or.

17TH CENTURY EARLY
LATER AND MODERN

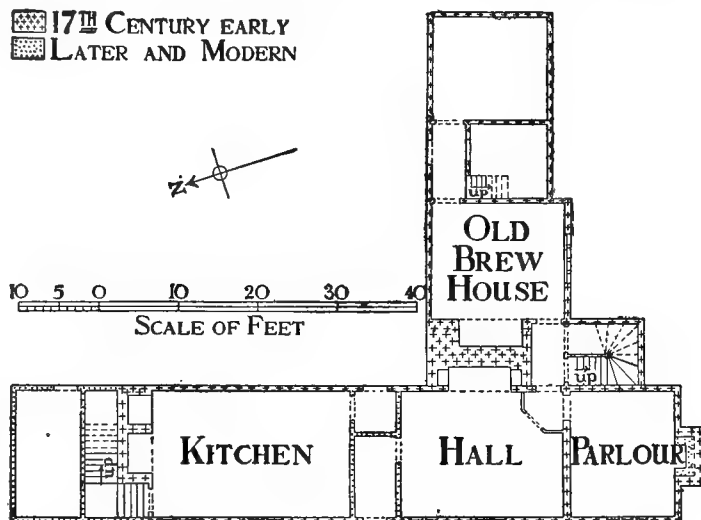

PLAN OF ALSWICK HALL, LAYSTON

pirates that ever had been in this kingdom.' He was one of the founders of the East India Company, of which he was elected governor in 1601, and was also a member of the Virginian Company. He was Lord Mayor of London 1606-7 and died in 1616.⁴⁴ Thomas Hobson (1544?-1631), the carrier of Cambridge, whose business methods are said to have given rise to the proverb 'Hobson's choice,' was also born at Buntingford.⁴⁵

Daniel Langhorne, the antiquary, was appointed vicar of Layston in 1671 and held the living until his death in 1681.⁴⁶

The manor of *BEAUCHAMPS* *alias* *MANORS ALFLADEWICK* (Alfredawiche, xi cent.; Alflatesworth, Alfladewyk, xii cent.) was held by Godid, a 'man' of Asgar the

³⁹ These are external dimensions.

⁴⁰ Robert de Hailey was assessed for subsidies in 1296 and 1307 (Lay Subs. R. bde. 120, no. 5, 8). Nicholas son of Robert de Hailey, called of Epping, granted his lands in the parish to Robert atte Water of Ware for life in 1348 (Cal.

Close, 1346-9, p. 513). Joan widow of John Hotoft died seised of a tenement called Heylees near Buntingford in 1446 (Chan. Inq. p.m. 24 Hen. VI, no. 31).

⁴¹ Com. Pleas D.Enr.Hil. 21 Jas. I, m. 1.

⁴² *Dict. Nat. Biog.*; *East Herts. Arch. Soc. Trans.* iii, 220.

⁴³ *Dict. Nat. Biog.*

⁴⁴ *Ibid.* In 1602 he conveyed the rent of a house in Buntingford to trustees for the poor of the town (Close, 45 Eliz. pt. xii).

⁴⁵ *Dict. Nat. Biog.*

⁴⁶ *Ibid.*

A HISTORY OF HERTFORDSHIRE

Staller, in the time of Edward the Confessor.⁴⁷ In 1086 it had become part of the large possessions of Count Eustace of Boulogne, and was held of him by Rumold.⁴⁸ Count Eustace appears to have granted this fee with other lands either to his illegitimate son Geoffrey or to Geoffrey's son William of Boulogne,⁴⁹ who appears as overlord of Beauchamps shortly before his death in 1130.⁵⁰ He was succeeded by his son Faramus of Boulogne,⁵¹ whose daughter and heir Sybil married Ingelram de Fiennes.⁵² Ingelram de Fiennes was killed in battle in 1189. His son William de Fiennes was his heir⁵³ and appears as overlord of Beauchamps early in the 13th century.⁵⁴ After this date there is no further record of this family holding any rights in Beauchamps. They had apparently granted the services from this fee to one of the Vere family,⁵⁵ for Aubrey de Vere Earl of Oxford was returned as holding a fee in Alfladewick of the honour of Boulogne in 1210⁵⁶ and his successors are found as overlords of the manor.⁵⁷

In 1129 Alfladewick was held in demesne by Rumold, either the Rumold of 1086 or his son.⁶⁸ This Rumold had two sons, Payn and Bernard, one of whom, apparently Bernard,⁵⁹ married the sister of Hugh son of Wulfgar, and half Alfladewick and half the mill with the land attached to it were granted to Hugh by Rumold and his sons as his sister's dower.⁶⁰ The manor appears to have remained in Rumold's family for some time, though the descent is difficult to trace. In 1191 Robert Rumold was holding one knight's fee in Alfladewick,⁶¹ and in the 13th century reference is made to the mill of Rumold,⁶² but there is no evidence to show if this family⁶³ was then holding the manor, the history of which cannot be traced until the end of the 13th century, when it was held by the family of Beauchamp. Henry de Beauchamp styled of Alfladewick was living in 1278,⁶⁴ and in 1303 the manor was held by Peter de Beauchamp.⁶⁵ His son John de Beauchamp was assessed at 18*d.* for his goods in Alfladewick in 1307-8,⁶⁶ but the greater part of the Beauchamps' lands appear by this time to have been conveyed to William de Poley, who was assessed at 3*s.* at the same date.⁶⁷ In 1325 Margery widow of Peter de Beauchamp quitclaimed to William Poley of Buntingford all right in the lands which he held in Alfladewick of the gift of Peter de Beauchamp and his son John.⁶⁸ By 1420 the

'tenement called Beauchamps' had come to Joan Waleys, widow of John Waleys of Glynde. She died seized of it in that year and her lands descended to her four daughters and co-heirs, Beatrice, Joan, Agnes and Joan.⁶⁹ Beauchamps was inherited by Agnes, who was holding it with her husband John Burgh in 1434⁷⁰ and with her second husband John Patington in 1452.⁷¹ Agnes died in that year and the manor descended to her daughter Joan the wife of Ralph Grey, jun.,⁷² of Brent Pelham.⁷³ Joan was left a widow and became the wife of Edward Goldesborough.⁷⁴ She died in 1496 and Beauchamps passed to her granddaughter by her first marriage, Elizabeth Grey.⁷⁵ Elizabeth married Anthony the third son of Sir William Walgrave, kt., of Smallbridge, in Bures St. Mary co. Suffolk.⁷⁶ She died before 1552, in which year her husband and her second son Julian were holding the manor,⁷⁷ the reversion of which was settled on Julian.⁷⁸

In 1567 Anthony Walgrave conveyed the manor to William Naylor for the purpose of a grant to Edward Baesh,⁷⁹ William Walgrave, eldest son of Anthony and Elizabeth, quitclaiming his right to Edward Baesh and Thomasine his wife.⁸⁰ Edward with his second wife Jane, the daughter of Ralph Sadleir,⁸¹ settled the manor in 1579 on their second son William, with remainder to their eldest son Ralph.⁸² Edward Baesh died in 1587.⁸³ His son William probably predeceased him, as he was succeeded by Ralph,⁸⁴ who held Beauchamps until his death in 1598, when it descended to his son Edward Baesh.⁸⁶ The latter died without issue in 1653, and the manor apparently passed to his cousin Ralph Baesh⁸⁶ and was sold by him to John Taylor, afterwards rector of Westmill,⁸⁷ who was holding it in 1669.⁸⁸ A conveyance of that date to Edward Smith may have been in trust for Bernard Turner, who is said to have bought it from Taylor.⁸⁹ At Turner's death in 1696 Beauchamps descended to his son John, who gave it to his daughter Anne on her marriage with Thomas Crouch

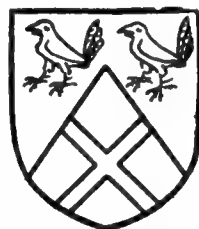

BAESH. *Party chevronwise argent and gules with two moorcocks sable in the chief and a saltire argent in the foot.*

⁴⁷ *V.C.H. Herts.* i, 321*b.* Godid was a woman.

⁴⁸ *Ibid.*

⁴⁹ *Gen.* (New Ser.), xii, 145 et seq.

⁵⁰ *Add. Chart.* 28346; see *Gen.* (New Ser.), xii, 151.

⁵¹ *Gen.* loc. cit.; *Add. Chart.* 28345; see *Red Bk. of Exch.* (Rolls Ser.), ii, 576.

⁵² *Gen.* loc. cit.

⁵³ *Ibid.*

⁵⁴ *Red Bk. of Exch.* (Rolls Ser.), ii, 576; *Testa de Nevill* (Rec. Com.), 273.

⁵⁵ Aubrey de Vere appears as witness to a settlement of the manor about 1130 (*Add. Chart.* 28344).

⁵⁶ *Red Bk. of Exch.* (Rolls Ser.), ii, 502.

⁵⁷ See *Testa de Nevill* (Rec. Com.), 270; *Feud. Aids*, ii, 431; *Chan. Inq.* p.m. 34 Edw. III, no. 84; 45 Edw. III, no. 45; 1 Hen. IV, no. 52; 3 Hen. VI, no. 35; *Chan. Inq.* p.m. (Ser. 2), xii, 70a; cccclxxiii, 15; G.E.C. *Complete Peerage*, s.v. Oxford.

⁵⁸ *Add. Chart.* 28346, 28345, 28344.

⁵⁹ *Ibid.*

⁶⁰ *Ibid.*

⁶¹ *Pipe R.* 3 Ric. I, m. 12*d.*, Essex and Herts.

⁶² *Anct. D.* (P.R.O.), A 5232, 5233.

⁶³ In 1285 an inquisition was held on a Robert Rumold who died seized of lands in Springfield, co. Essex, which he held in right of his wife Sybil de Boseville (*Chan. Inq.* p.m. 13 Edw. I, no. 118). He left no male heirs. His widow married as her second husband Geoffrey de Beauchamp, but this connexion of the two families appears to be a coincidence and does not explain the descent of the manor of Alfladewick.

⁶⁴ *Assize R.* 323, m. 44.

⁶⁵ *Feud. Aids*, ii, 431.

⁶⁶ *Lay Subs. R.* bdle. 120, no. 8 (1 Edw. II).

⁶⁷ *Ibid.*

⁶⁸ *Anct. D.* (P.R.O.), A 991; see A 1170.

⁶⁹ *Chan. Inq.* p.m. 3 Hen. VI, no. 35.

⁷⁰ *Feet of F. Herts.* Mich. 13 Hen. VI, no. 74.

⁷¹ See *ibid.* 31 Hen. VI, no. 161.

⁷² *Chan. Inq.* p.m. 31 Hen. VI, no. 17.

⁷³ *Visit. of Essex* (Harl. Soc.), i, 122.

⁷⁴ See *Chan. Inq.* p.m. (Ser. 2), xii, 70a.

⁷⁵ *Ibid.*

⁷⁶ *Visit. of Essex* (Harl. Soc.), i, 122, 309.

⁷⁷ *Feet of F. Herts.* East. 6 Edw. VI.

⁷⁸ See *Com. Pleas D. Enr. Mich.* 9 & 10 Eliz. m. 23.

⁷⁹ *Ibid.* Julian's interest disappears.

⁸⁰ *Feet of F. Herts.* Mich. 9 & 10 Eliz.

⁸¹ *Visit. of Herts.* (Harl. Soc.), 125.

⁸² *Com. Pleas D. Enr. Trin.* 21 Eliz. m. 7*d.*

⁸³ *Chan. Inq.* p.m. (Ser. 2), ccxv, 269.

⁸⁴ *Ibid.*

⁸⁵ *Ct. of Wards, Feod. Surv.* 17.

⁸⁶ For descent of the family of Baesh see the manor of Stanstead Abbots, Braughing Hundred.

⁸⁷ *Chauncy, Hist. Antiq. of Herts.* 133.

⁸⁸ *Feet of F. Herts.* Mich. 21 Chas. II.

⁸⁹ *Chauncy, loc. cit.*

of Corneybury.⁹⁰ On Anne's death the manor passed to her son Charles,⁹¹ who sold it in 1726 to Francis Lordston.⁹² In 1731 Francis succeeded his father as lord of the manor of Wyddial⁹³ (q.v.) and from this date the two manors have descended together.⁹⁴ Beauchamps has no longer any manorial rights.

In the reign of Edward the Confessor the manor of *ALSWICK* (Alsieswiche, xi cent.; Ayshesaldwyk, Alsleswick, xiii cent.; Alstwyk, xiv cent.; Alcewyk, xv cent.; Alwilcewike, Alesborne, Alleswike, xvi cent.; Awlswick, xvii cent.) was held by Almar of Earl Gyrth, the brother of Harold.⁹⁵ After the Conquest it became part of the possessions of Ralph Baynard and in 1086 was held of him by his tenant William. It was then assessed at 6 hides.⁹⁶ The honour of Baynard escheated to the Crown in the reign of Henry I and was granted to Robertson of Richardson of Gilbert de Clare, founder of the house of Fitz Walter.⁹⁷ The overlordship of Alswick Manor descended with the family of Fitz Walter,⁹⁸ whose rights in Alswick can be traced down to 1328.⁹⁹

William, the tenant of 1086, was succeeded before the middle of the 12th century by Richard Fitz William, who granted the chapel of Alswick to the Prior and convent of Holy Trinity.¹⁰⁰ This grant appears to have accompanied a gift of the whole or part of the manor, for in 1291 the prior's lands in Layston with services and a mill there were assessed at £19 10s. 7½d.¹ In 1397 Geoffrey Cornhill of Springfield and Margaret his wife were holding a manor of Alswick,² possibly as farmers or mortgagees, and in 1432 John Olyver and Ida his wife levied a fine of the manor.³ In 1531 the priory of Holy Trinity was dissolved⁴ and its lands in Alswick and elsewhere were granted to Sir Thomas Audley.⁵ The manor of Alswick appears to have passed to William Ayloff and Alice his wife, who sold it to John Crouch.⁶ In February 1605-6 John Crouch died seised of the manor, which descended to his son John.⁷ He died in 1615.⁸ His son John suffered a recovery of the manor in 1662,⁹ and on his death it descended to his son Pike Crouch,¹⁰ who died

in 1712.¹¹ John Crouch, son of Pike, conveyed the manor in 1720 to Jacob Houblon,¹² who appears to have been one of the executors of Charles Houblon.¹³ Jacob son and heir of Charles Houblon came of age in 1731 and inherited the manor.¹⁴ It descended to his son Jacob in 1770,¹⁵ to John Archer-Houblon, son of Jacob, in 1831, and at the latter's death to his son John Archer-Houblon of Hallingbury, co. Essex.¹⁶ It has recently been bought from Colonel G. B. Archer-Houblon by Mr. J. R. Russell, farmer, of Westmill Bury.

The manor of *GIBERACK* (Gyvrake, Gibcracke, xvi cent.), the earliest reference to which by name occurs in the 16th century, appears to represent the



ALSWICK HALL, LAYSTON, FROM THE SOUTH-EAST

lands held by the nuns of Holywell. In 1217 the Prioress and nuns of Holywell claimed from Holy

⁹⁰ Cussans, *Hist. of Herts. Edwinstree Hund.* 122.

⁹¹ Clutterbuck, *Hist. of Herts.* iii, 431; see *Recov. R. Mich.* 7 Geo. I, rot. 55; *Feet of F. Herts.* Mich. 7 Geo. I.

⁹² Clutterbuck, loc. cit. ⁹³ *Ibid.*
⁹⁴ See *Recov. R. Mich.* 2 Geo. III, rot. 149; 8 Geo. IV, rot. 220.

⁹⁵ *V.C.H. Herts.* i, 326a. ⁹⁶ *Ibid.*
⁹⁷ See *ibid. Essex.* i, 346; G.E.C. *Complete Peerage*, s.v. Fitz Walter for the descent of this honour.

⁹⁸ *Testa de Nevill (Rec. Com.)*, 284; *Feud. Aids*, ii, 431; *Cal. Inq. p.m.* 1-9

Edw. III, 129; *Cal. Close*, 1327-40, p. 340.

⁹⁹ *Cal. Close*, 1327-40, p. 340.

¹⁰⁰ *Dugdale, Mon.* vi, 152.

¹ *Pope Nich. Tax. (Rec. Com.)*, 14b;

see *Testa de Nevill (Rec. Com.)*, 284;

Feud. Aids, ii, 431, 446.

² *Feet of F. Herts.* 21 Ric. II, no. 178.

³ *Ibid.* Mich. 11 Hen. VI.

⁴ *Dugdale, Mon.* vi, 150.

⁵ *L. and P. Hen. VIII*, xii (2), 1027.

There are so few records of Alswick Manor that it cannot be certainly proved that Holy Trinity held it, but the pre-

sumption is that the manorial rights went with their estate.

⁶ See *Chan. Inq. p.m. (Ser. 2)*, cclcvii, 50.

⁷ *Chan. Inq. p.m. (Ser. 2)*, ccxciv, 86; P.C.C. 22 Stafford.

⁸ *Chan. Inq. p.m. (Ser. 2)*, cclcvii, 50.

⁹ *Recov. R. Mich.* 14 Chas. II, rot. 185.

¹⁰ *Chauncy, Hist. Antiq. of Herts.* 132;

see *Feet of F. Herts.* Hil. 8 Will. III.

¹¹ *Clutterbuck, Hist. and Antiq. of Herts.*

iii, 436.

¹² *Recov. R. East.* 6 Geo. I, rot. 226.

¹³ *Cussans, Hist. of Herts. Edwinstree*

Hund. 82. ¹⁴ *Ibid.* ¹⁵ *Ibid.* ¹⁶ *Ibid.*

A HISTORY OF HERTFORDSHIRE

Trinity an eleventh part of a knight's fee in Alswick, and in 1239 the prior granted them certain lands with a mill in Alswick to hold of him and his successors.¹⁷ These lands remained with Holywell until the 16th century,¹⁸ when they were farmed of the convent by Holy Trinity for £5 6s. 8d.¹⁹ The lands of Holy Trinity passed to Sir Thomas Audley after its dissolution in 1531, and he continued to farm the manor of Giberack of the nuns of Holywell until 1537, when he purchased it of the convent.²⁰ From this date Giberack descended with Sir Thomas's manor of Corneybury in Wyddial²¹ (q.v.). It is mentioned in conveyances of that manor as late as 1811.²²

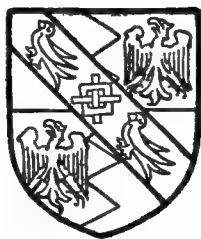

AUDLEY. Quarterly palewise indented or and azure a bend azure charged with a fret between two martlets or in the azure quarters.

In the 17th century there are records of a manor called *DOWNHALL* in Layston. This was held by John Crouch with the manor of Alswick in 1605,²³ and it is possible that it consisted of lands held by the convent of Holy Trinity in the neighbourhood of St. Bartholomew's Church.²⁴ Downhall descended with the manor of Alswick,²⁵ the last reference to it occurring in 1720, and it is probable that after that date the two manors became merged.

In the 13th century certain lands in Alswick were held by Gilbert de Sanford, lord of the manor of Great Hormead.²⁶ They descended through his daughter to the Veres,²⁷ and in 1328 were assessed at one-third of a knight's fee.²⁸ No record of this as a separate holding occurs after this date and it was probably included in the manor of Great Hormead.

In the Domesday Survey several holdings are recorded in *HICHINTON* (Ichetone, xi cent.; Hitchentuna, xii cent.; Ykinton, Hygenton, xiii cent.), which apparently lay within the area comprised by the later parish of Layston.²⁹

In the reign of Edward the Confessor 1 hide of land in Ichetone was divided among four sokemen, one a man of Archbishop Stigand, two the men of King Edward, who paid by custom 2d., and the fourth a man of King Harold.³⁰ By 1086 this land had become the property of the Bishop of Bayeux and was held of him by Osbern.³¹ This holding appears afterwards as a half-fee belonging to the Ports,³² and apparently descended with the manor of Pope's Hall in Buckland (q.v.). It is lost sight of after the 14th century and was probably absorbed into the manor of Buckland, which, according to later entries, lay partly in Layston.³³ It was probably on account of this

holding that Elizabeth de Burgh, lady of Pope's Hall, was able to transfer her market from New Chipping to Buntingford in 1360.

Another Saxon holding at Ichetone was the half hide of Godid, a 'man' of Asgar the Staller. After the Conquest this land came into the hands of Count Eustace of Boulogne and was held of him by Rumold,³⁴ the tenant of Alfladewick, and it appears with Alfladewick in the settlement made by Bernard son of Rumold³⁵ (see above). In the 13th century it appears with Alfladewick among the fees of the honour of Boulogne.³⁶ No separate record of it occurs after this time.

Twenty acres of land in Ichetone, which had been held by Godid, also came into the possession of Count Eustace, but were held of him separately by two knights.³⁷

Another half hide which had been held by the Saxon Ethelmær of Benington passed with his other lands to Peter de Valognes after the Conquest and was held of him by Humfrey.³⁸ This holding was probably attached to the neighbouring manor of Stonbury, which was also held by Peter de Valognes,³⁹ for it cannot be traced in Layston after this date. A small holding of 3 virgates and 6 acres, which had been held by two sokemen, who paid the sheriff 3d. yearly, had passed by 1086 to Hardwin de Scales and was held of him by Theobald.⁴⁰ It was probably part of the Scales' holding in Throcking, of which Theobald was also tenant in 1086,⁴¹ for at the beginning of the 15th century Geoffrey de Bermingham was holding land in Ichington near Buntingford of the manor of Throcking.⁴² Six acres of land also in Ichetone were held under Edward the Confessor by Aldred, one of his thegns, and after the Conquest passed to Eudo Fitz Hubert and were held of him by

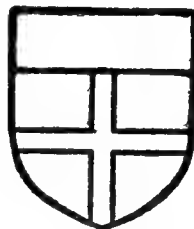

KNIGHTS TEMPLARS. Argent a cross gules and a chief sable.

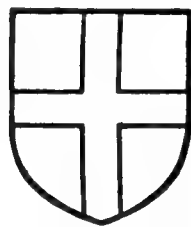

KNIGHTS HOSPITALERS. Gules a cross argent.

Walter.⁴³ These small holdings probably were absorbed into neighbouring manors.

In the 13th century the Knights Templars held land in Buntingford. In 1296 Robert de Gonerwardby granted them 8d. rent there which was held

¹⁷ Dugdale, *Mon.* iv, 394.
¹⁸ See *Feud. Aids*, ii, 431; *Valor Eccl. (Rec. Com.)*, i, 394.
¹⁹ *Valor Eccl.* loc. cit.
²⁰ *L. and P. Hen. VIII*, xii (2), 1027.
²¹ Feet of F. Herts. East. 32 Hen. VIII; Hil. 14 Geo. II; Chan. Inq. p.m. (Ser. 2), clxi, 79; elxii, 167.
²² Feet of F. Herts. East. 51 Geo. III.
²³ Chan. Inq. p.m. (Ser. 2), ccclvii, 50.
²⁴ It is improbable that the convent would have the advowson of a church surrounded by alien territory. Its appearance at such a late date suggests that it was monastic land.

²⁵ See references under that manor.
²⁶ *Testa de Nevill* (Rec. Com.), 284.
²⁷ *Feud. Aids*, ii, 431.
²⁸ For this descent see manor of Great Hormead.
²⁹ *Cal. Inq. p.m.* 1-9 Edw. III, 129.
³⁰ See *Cal. Pat.* 1225-32, p. 368, from which it is apparent that Hichinton was close to Corney. In the 12th century a branch of the Hakun family lived at Hichinton and took their name from it (*Rot. Cur. Reg.* [Rec. Com.], i, 160, 165; Anct. D. [P.R.O.], A 994).
³¹ *V.C.H. Herts.* i, 310b.
³² *Ibid.*

³³ *Red Bk. of Exch.* (Rolls Ser.), ii, 506; *Testa de Nevill* (Rec. Com.), 270.
³⁴ Pat. 12 Eliz. pt. ix; Chan. Inq. p.m. (Ser. 2), cclxxiv, 96.
³⁵ *V.C.H. Herts.* i, 321b.
³⁶ Add. Chart. 28344.
³⁷ *Red Bk. of Exch.* (Rolls Ser.), ii, 502, 576; *Testa de Nevill* (Rec. Com.), 270, 273.
³⁸ *V.C.H. Herts.* i, 321b.
³⁹ *Ibid.* 337b, 268.
⁴⁰ *Ibid.* 337b.
⁴¹ *Ibid.* 340a.
⁴² Chan. Inq. p.m. 12 Hen. IV no. 37.
⁴³ *Ibid.* 329a.

of the Templars with suit at their court of Buntingford.⁴⁴ This holding passed with the Templars' other lands to the Knights Hospitallers in 1309.⁴⁵ After the Dissolution part of the Hospitallers' lands in Buntingford were granted with the preceptory of Shingay⁴⁶ and part was attached to the manor of Standon⁴⁷ in Braughing Hundred (q.v.).

The church of *ST. BARTHOLOMEW* consists of chancel 30 ft. 3 in. by 17 ft., nave 52 ft. by 27 ft., west tower 14 ft. square and south porch 10 ft. by 9 ft. 6 in.; all internal dimensions. The walls are of flint rubble, partly cemented; the base-course of the tower has a chequer ornament of flint and stone in 9-in. squares. The nave roof is slated and the chancel roof tiled.

The chancel belongs to the early part of the 13th century; the nave and west tower appear to have been built in the 15th century—1400–20. The moulding on the base-course round the tower appears also at the north-east and north-west angles of the nave. The south porch probably dates from the early part of the 16th century; it was formerly built of brick with stone dressings, but the church having fallen into a bad state of repair, from disuse, it was

arch; the inner jambs have a wide casement moulding. At the east end of the south wall is a 13th-century piscina with rebated jambs, much broken, and shouldered head similar to the aumbry in the east wall. Set in the south wall is a stone corbel carved with a grotesque face and with remains of colouring. It is of 15th-century date and probably supported an image; it is not in its original position. The chancel arch is slightly four-centred and is of two moulded orders without a label; the jambs have round engaged shafts with moulded capitals and bases.

In the north wall of the nave are two three-light and one two-light window of the 15th century, having cinquefoiled lights under four-centred arches, with wide casement mouldings to the inner jambs; the outer stonework of the two three-light windows is modern. The north doorway is blocked; it has a pointed arch and a moulded square label inside. In the south wall are three windows similar to those in the north wall; some of the external stonework has been renewed. The south doorway is of 15th-century date with moulded arch and jambs; over the doorway inside is a square moulded label, as on the north.

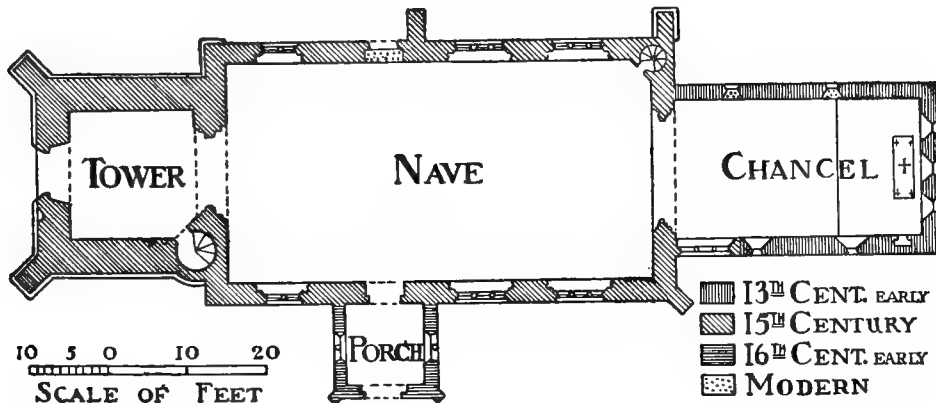

PLAN OF LAYSTON CHURCH

in 1906 thoroughly repaired. Much of the old stonework was renewed, the porch was faced with flint and the walling generally repaired.⁴⁸

In the east wall of the chancel are three single lancets of the 13th century; underneath them, inside, is a moulded string-course of the same period. Under the string-course, at the north end of the communion table, is a small aumbry or niche with shouldered head, probably of 13th-century date. In the north wall are two blocked lancets; the stonework of the western one has been renewed. In the south wall are two 13th-century lancets; below the westernmost is a narrow doorway with pointed splayed arch of 15th-century date. Near the western end of the wall is a 15th-century window of three cinquefoiled lights with tracery under a four-centred

In the north-east angle of the nave is the doorway to the rood-stair turret; the stair is gone.

The south porch has an entrance archway of two moulded orders, the inner one forming a four-centred arch, the outer carried over square with moulded label; the spandrels are traceried and carved with foliage. Above the entrance is a niche with cinquefoiled ogee arch with carved crockets and finial and crocketed pilaster buttresses on either side; the niche is embattled above. On either side of the porch is a two-light cusped window, mostly of modern stonework. All the roofs throughout the church are modern.

The west tower is of three stages, with diagonal buttresses, embattled parapet and small leaded spire. The turret stair is in the south-east angle. The tower

⁴⁴ Chan. Inq. a.q.d. 24 Edw. I, file 25, no. 3.

⁴⁵ See *Cal. Pat.* 1307–13, p. 131; 1327–30, p. 531.

⁴⁶ *L. and P. Hen. VIII*, xv, g. 613 (1).

⁴⁷ *Ibid.* xvi, g. 379 (26); xix (2), g. 166 (70).

⁴⁸ In 1522 James Pole directed that his body should be buried in the church

of the Holy Apostle St. Bartholomew of Layston (P.C.C. 26 Maynwaring). In 1494 Ellen Barbour left to the making of a glass window in Layston Church £3 or as much money as the window should cost. She directed that four timber crosses should be erected over her husband's and her own sepulchre. She left 26s. 8d. for the repair of the bridge 'in the chapel end' in Bunting-

ford and 6s. 8d. for making a cross in Buntingford (*ibid.* 18 Vox). In 1524 John Sawyer directed that his body should be buried in the church of St. Bartholomew of Layston and left as much money as it would cost to make a buttress on the north wall of the church (*ibid.* 31 Bodfelde). An action arose as to the building of the buttress (*Town Depositions*, 26 Hen. VIII, bde. 1).

A HISTORY OF HERTFORDSHIRE

arch is of 15th-century date of three moulded orders, the outer two continuous, the inner resting on a semi-octagonal shaft with moulded capitals and bases. The west door has a pointed arch of two orders under a square head and moulded label; the cusped spandrels contain blank shields. Above the doorway is a string-course, of which the label forms the lower member, carried along the west face of the tower; it is carved with leaves at close intervals. Beside the south jamb of the doorway externally are the remains of a stoup, elliptical on plan, with four-centred cinquefoiled arch. Thorley is the only other example in the county of a stoup at the west doorway. The west window has three cinquefoiled lights with tracery under a pointed arch; on each of the north, south and west sides of the second stage is a narrow loop light. The belfry windows are of two cinquefoiled lights with quatrefoil in the head.

The font is of 15th-century date. The bowl is

chapel of ease in Buntingford consists of silver-gilt cup, 1681, silver-gilt paten and large salver, 1683.

The registers before 1812 are as follows: (i), (ii), (iii), and (iv) baptisms and burials 1563 to 1800, marriages 1563 to 1753; (v) baptisms and burials 1801 to 1812; (vi) marriages 1754 to 1812.

The chapel of ease, dedicated to *ST. PETER*, consists of chancel 21 ft. by 13 ft. with apse, nave 39 ft. 6 in. by 21 ft., east and west transepts each 11 ft. 6 in. deep by 24 ft. wide, modern vestry and north porch; all dimensions are internal. The walls are of red brick and the roofs are tiled.

The chapel was built about 1614 by the Rev. Alexander Strange, as is recorded on the brass within the chapel.^{48a} It is in the form of a cross with the chancel and apse on the south. In 1899 the building was thoroughly restored, a vestry was erected west of the chancel, a new north porch was added, the walls of the apse were raised and a new roof put on, new

brick windows were inserted throughout, the original pews with carved backs were removed and modern seating substituted.

The chancel opens into the semicircular apse by a modern arch of red brick. There is a modern window on the east side. There is no chancel arch.

The nave has modern windows and a modern north doorway and porch. In the west transept is a gallery with plain panelled front, of about 1615, supported on small round wooden columns with Ionic capitals and bases. In the west wall is a doorway with the original four-centred brick

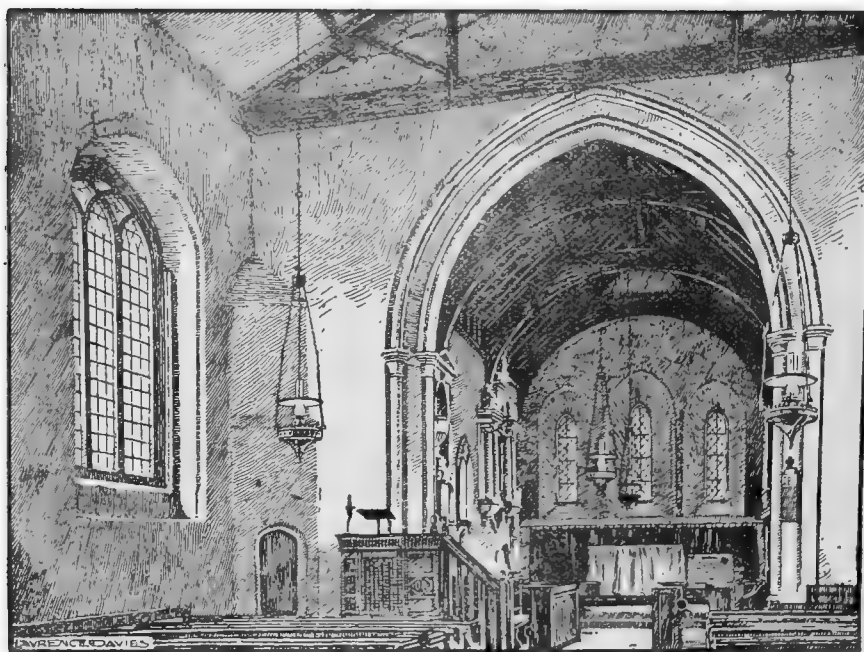

LAYSTON CHURCH: THE CHANCEL FROM THE NAVE

arch; the jambs are of modern brickwork. The windows in both transepts are modern. Over the north gable is a small brick bellcote and in the east gable is a stone inscribed *DOMUS ORATIONIS*, 1615. All the roofs are modern, but several plain tie-beams of the original roof remain. The pulpit is made up of panels from the old pews, with arabesque carving in the upper panels. Some of the chancel seats also contain old panels, and some have buttressed ends similar to those at Layston Church, from which they probably came. On the south wall of the east transept is a brass engraved with a view of the interior of a small Renaissance chapel during service; it, however, bears little resemblance to the existing building. The preacher in the pulpit and the congregation are also shown. It is to Alexander Strange, vicar of Layston and builder of the chapel; it bears the date 1620. In the north window is a shield of

octagonal with a circular quatrefoiled panel on each face. The octagonal pedestal has traceried panels, in some of which are small shields carved with emblems of the Passion, much worn; several shields have disappeared. The pulpit is made up of panelling of the 16th and 17th centuries; in the front is a linen panel. Most of the seating is of 15th-century date with buttressed ends and moulded rails.

In the north-west angle of the nave is a slab with indents of two men, two women and children. On the north chancel wall is a mural monument of marble and alabaster to John Crouch, 1605, with the arms of himself, his wife and the alliances of his ten children. On the south wall of the nave is a tablet to William Slatholme, Doctor of Physics, 1665.

There are five bells, four of them dated 1633, the fifth by Pack & Chapman, 1776.

The communion plate which is used at St. Peter's

arch; the jambs are of modern brickwork. The windows in both transepts are modern. Over the north gable is a small brick bellcote and in the east gable is a stone inscribed *DOMUS ORATIONIS*, 1615. All the roofs are modern, but several plain tie-beams of the original roof remain. The pulpit is made up of panels from the old pews, with arabesque carving in the upper panels. Some of the chancel seats also contain old panels, and some have buttressed ends similar to those at Layston Church, from which they probably came. On the south wall of the east transept is a brass engraved with a view of the interior of a small Renaissance chapel during service; it, however, bears little resemblance to the existing building. The preacher in the pulpit and the congregation are also shown. It is to Alexander Strange, vicar of Layston and builder of the chapel; it bears the date 1620. In the north window is a shield of

^{48a} See also below under adwoson.

arms : quarterly, 1 and 4, Argent a cheveron sable between three rooks proper, each holding an ermine tail in its beak sable ; 2 and 3, Or a leopard gules, with the crest of a rook. Underneath is the inscription : 'This windowe was mad & . . . ed at the only Charges of William and Mary Reynolds the sonne and daughter of Lewes Reynolds sometyme Vicar of Laist[on]e. 1622.'

The earliest reference to the church of St. Bartholomew occurs in the reign of Henry II when Hugh ADVOWSONS Triket gave the manor of Corneybury in Wyddial to the Prior and canons of Holy Trinity, London, and also remitted them all right in the church of Layston which they had formerly held of him and his ancestors.⁴⁹ They received licence to appropriate the vicarage from Richard Fitz Neal,⁵⁰ Bishop of London 1189 to 1198.⁵¹ The advowson and rectory of St. Bartholomew descended after the Dissolution with the manor of Corneybury.⁵² By the beginning of the 17th century it was found that the position occupied by the church was inconvenient. The River Rib flowed between the town of Buntingford and the parish church, and although there was little more than half a mile between the two, the road was sometimes rendered impassable by floods.⁵³ It was therefore determined to build a chapel of ease in Buntingford, and from this time St. Bartholomew's, although the mother church, became of diminishing importance. At the end of the 19th century services were only held there in the summer months⁵⁴ and its condition was described as deplorable.⁵⁵

The patronage of the church of St. Mary Magdalene, Alswick,⁵⁶ was originally in the hands of the lord of the manor of Alswick, but when in the reign of Henry II the church of Layston was granted to the Prior and canons of Holy Trinity, Richard Fitz William, lord of the manor of Alswick (q.v.), made a grant to the prior of all his right in the church⁵⁷ and acknowledged it to be a chapel to the mother church of Layston. After the dissolution of Holy Trinity in 1531⁵⁸ the king sold the chapel to Sir Henry Parker, who took for his own use the church plate, which was valued at £6, and sold the bells and all the timber, lead and stone of the chapel to William Hammond and Henry Grave of Buntingford.⁵⁹ The

chapel was never restored, but its site may still be traced on the south side of Alswick Hall.

The advowson of the chapel of St. John the Baptist, Buntingford, belonged to the lord of the manor of Throcking and was attached to the part of the manor called Vabadun's fee.⁶⁰ In 1292 Roger Brian, lord of the manor of Throcking, founded a chantry there and granted 2 acres of land and 100s. rent in Hinxworth, Throcking, Clothall and Aspenden for the support of a chaplain.⁶¹ By the end of the 15th century the chapel was evidently in want of repair, for Leonard Hyde, by his will proved February 1508-9, left 40s. for its 'fynysshing . . . if the parson of Throcking or any other well disposed man will it edify.'⁶² By this it is probable that at this date the chapel had no chaplain of its own, but was served by the rector of Throcking. By the end of the following century the chapel had fallen into such decay that it could no longer be used.⁶³ The loss of it was much felt by the people of Buntingford, who had been accustomed to attend the

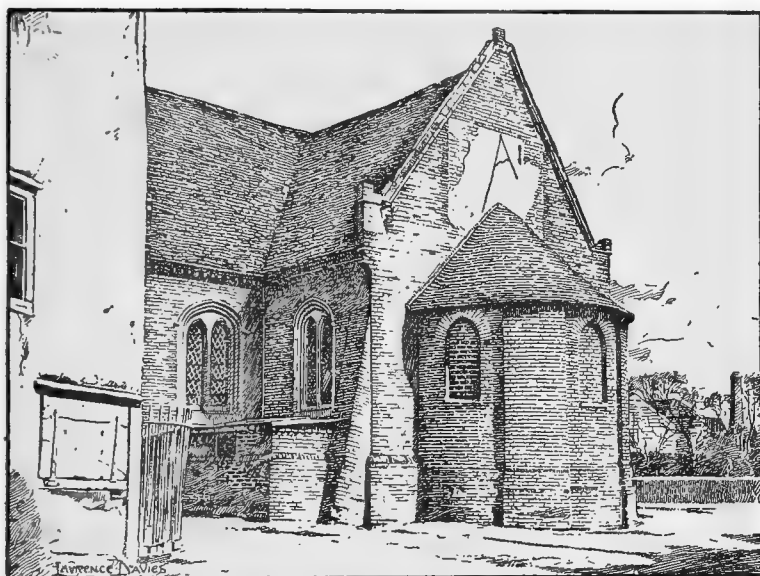

BUNTINGFORD : ST. PETER'S CHAPEL FROM THE SOUTH-WEST (before 1899)

chapel and who were frequently cut off from the church of Layston by the floods of the River Rib.⁶⁴ The difficulty was met by the Rev. Alexander Strange, the vicar of Layston, who, taking as his motto 'Beggard or beggard,' exerted himself to collect money to rebuild the chapel. In 1614 the present chapel was begun and in 1628 it was completed and rededicated to St. Peter. From the time of its rebuilding the advowson of St. Peter's Chapel has descended with Layston Church, to which it has been a chapel of ease.

⁴⁹ Dugdale, *Mon.* vi, 152.

⁵⁰ Newcourt, *Reper.* i, 843.

⁵¹ Stubbs, *Reg. Sacrum. Anglicanum*, 151.

⁵² See references under that manor.

⁵³ Lond. Epis. Reg. Grindall, fol. 396.

⁵⁴ Cussans, op. cit. *Hund. of Edwinstree*, 84.

⁵⁵ *East Herts. Arch. Soc. Trans.* ii, 84.

⁵⁶ In 1500 John Donne directed that his body should be buried in the church of Layston and left 12d. to the altar of our Lady of Alswick (P.C.C. Wills, 5 Moone). It would appear from this that the dedication was formerly to St. Mary the Virgin and the church had not the right of burial.

⁵⁷ Dugdale, *Mon.* vi, 152.

⁵⁸ *Ibid.* 150.

⁵⁹ Aug. Off. Misc. Bks. cccxcvii, fol. 1.

⁶⁰ De Banco R. 273, m. 75 d. (East. 2 Edw. III).

⁶¹ Chan. Inq. p.m. 20 Edw. I, no. 119 ; *Cal. Pat.* 1281-92, p. 486.

⁶² Cussans, op. cit. *Hund. of Edwinstree*, 151.

⁶³ Lond. Epis. Reg. Grindall, fol. 396.

⁶⁴ *Ibid.*

A HISTORY OF HERTFORDSHIRE

A house belonging to the brotherhood of the Blessed Virgin Mary in Buntingford was granted in 1561 to Thomas Paynell.⁶⁵

The parochial charities are administered together by a body of trustees appointed by an order of the Charity Commissioners of 8 June 1877. They include the charities of:—

Henry Skynner, founded by will 1558, endowed with houses (including the Angel Inn) and land of the annual value of £140 or thereabouts.

Sir John Watts, deed 1603, consisting of a rent-charge of £4 issuing out of land in Buntingford.

Joan Sandbach, will 1605, trust fund, £80 2½ per cent. annuities arising from the redemption in 1899 of a rent-charge of £2.

Bishop Seth Ward for apprenticing poor boys, will 1687, trust fund, £106 3s. 7d. 2½ per cent. annuities, being part of a sum of £480 stock arising from the redemption in 1899 of a rent-charge of £12, the balance having been expended in 1907 in the rebuilding of a house belonging to the charities.

William Bigg, will proved in the P.C.C. 2 July 1847, trust fund, £179 5s. 1d. consols.

The several sums of stock are held by the official trustees, producing together £9 2s. 4d. in yearly dividends.

John Crouch, deed 12 September 1631, being an annuity of £5 now charged upon land at Alswick Hall and applied in the distribution of bread.

The net income of the parochial charities is applied mainly in the distribution of bread, coal and other articles in kind.

Charities connected with Buntingford Chapel.— In 1642 the Rev. Alexander Strange, a former vicar, by deed granted to trustees land in Great Horstead and Layston, the rents and profits to be employed in the repairs of the chapel. In 1911 the sum of £3 16s., being the net rents of 6a. 2r., was so applied; and the Rev. Charles Heaton, by will proved in the P.C.C. 13 March 1754, devised an annuity of £2 charged upon land in Snayles Mead for a similar purpose.

The hospital founded and endowed by Seth Ward, Bishop of Salisbury, for four poor men and four poor women is regulated by orders and constitutions made and ordained by the founder by deed, 4 December 1684, as modified by a scheme of the Charity Commissioners of 21 June 1910.

The endowments consist of certain fee-farm rents payable out of lands and hereditaments in the counties of Leicester and Lincoln, in respect of which £89 11s. 11d. was received in 1911; also £274 9s. 11d. India 3 per cent. stock with the official trustees, producing £8 4s. 8d. yearly, and £1,000 consols, derived under the will of the late Miss Mary Leader, proved at London 5 February 1909, producing £25 a year. Each of the inmates receives 5s. a week and 1s. at Christmas and an allowance for coals.

The Buntingford Grammar School has already been dealt with.⁶⁶

MEESDEN

Mesdone (xi cent.); Mesdun, Misedon, Miesdun (xiii cent.); Mysendon, Meseden (xvi cent.); Messendon, Meesden (xvii cent.).

Meesden is a small parish in the north-east corner of Edwinstree Hundred, separated from the county of Essex by the River Stort. On the east of the parish near the river the ground is about 350 ft. above the ordnance datum, rising to 400 ft. near St. Mary's Church and to about 450 ft. further west at Meesden Green. The area of the parish is 1,008 acres, of which about four-fifths are arable land.¹ In the 11th century the parish was thickly wooded, yielding woodland, according to the Domesday Survey, for 400 swine.² Court rolls for the 15th century show that quantities of oaks and ashes were then being cut down on the manor.³ Meesdenhall Wood to the south of the church and White Hill and Smaley Wood in the north-west of the parish are now the only woods remaining.

No main road runs through the parish. The church of St. Mary is situated a little to the east of a road running north from Brent Pelham to Langley. Meesden Bury, the manor-house, now a farm, lies nearly a quarter of a mile to the north of the church, with which it is connected by a footpath. At Meesden Bury is a homestead moat. The moated manor-house is mentioned in 1418, when it was presented

at the court that a chamber within the moat was ruinous and had fallen to the ground and that the timber of the chamber and of the bridge over the moat had disappeared.⁴ In the same year it was presented that the dairy-house, the wheel-barn, the hay-barn and the stable were out of repair.⁵ The present house is modern. To the south of the church is the rectory and a little to the west the Rectory Farm. The glebe is a large estate of 100 acres. Baron C. R. S. Dimsdale lives at Meesden Manor, formerly called Smaley Lodge.

The village of Meesden, which is very small, is situated round Meesden Green, about half a mile west of the church. The school was built about 1874. From the village Willoughby Lane and the footpath its continuation run south to the old windmill near Cole Green in Brent Pelham parish. This perhaps replaced the manorial mill mentioned in the 14th century and later. A road running west from the village towards Anstey passes Lower Green, where are one or two houses.

An inclosure award was made for Meesden in 1841.⁶ Millfield, Westfield, Southfield, Longland, Chittoksleye and Romstedefield were among the field-names.⁷ Other place-names occurring are Pourtesheigh, Crispyscroft, Balardscroft, Gallowcroft, Remsaky, Warewykis, Fykeysiswick, Chalcroftmede,

⁶⁵ Pat. 3 Eliz. pt. x.

⁶⁶ *V.C.H. Herts.* ii, 94; and see above.

¹ Statistics from Bd. of Agric. (1905).

² *V.C.H. Herts.* i, 307b.

³ Ct. R. (Gen. Ser.), portf. 178, no. 2. In 1418 it was presented that an oak

which lay in the waste was needed for the 'groundsell' of the church porch, but could not be taken until licence for its removal was given by the lord (*ibid.*). Another presentment made in 1424 shows that bees were taken out of an oak

belonging to the lord in Bury Wood and the oak was burned for the honey and the wax (*ibid.*).

⁴ *Ibid.*

⁵ *Ibid.*

⁶ *Blue Bk. Incl. Awards*, 64.

⁷ *Mins. Accts. bdle.* 867, no. 6, 7.

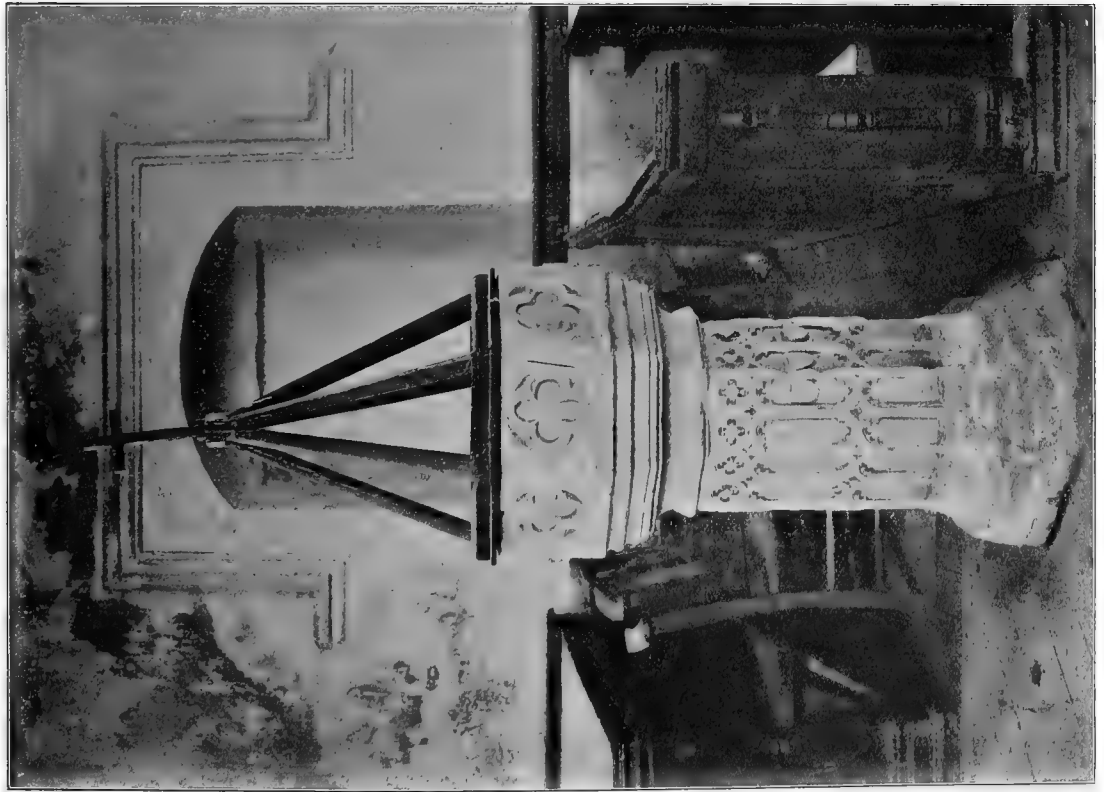

LAYSTON CHURCH : THE FONT

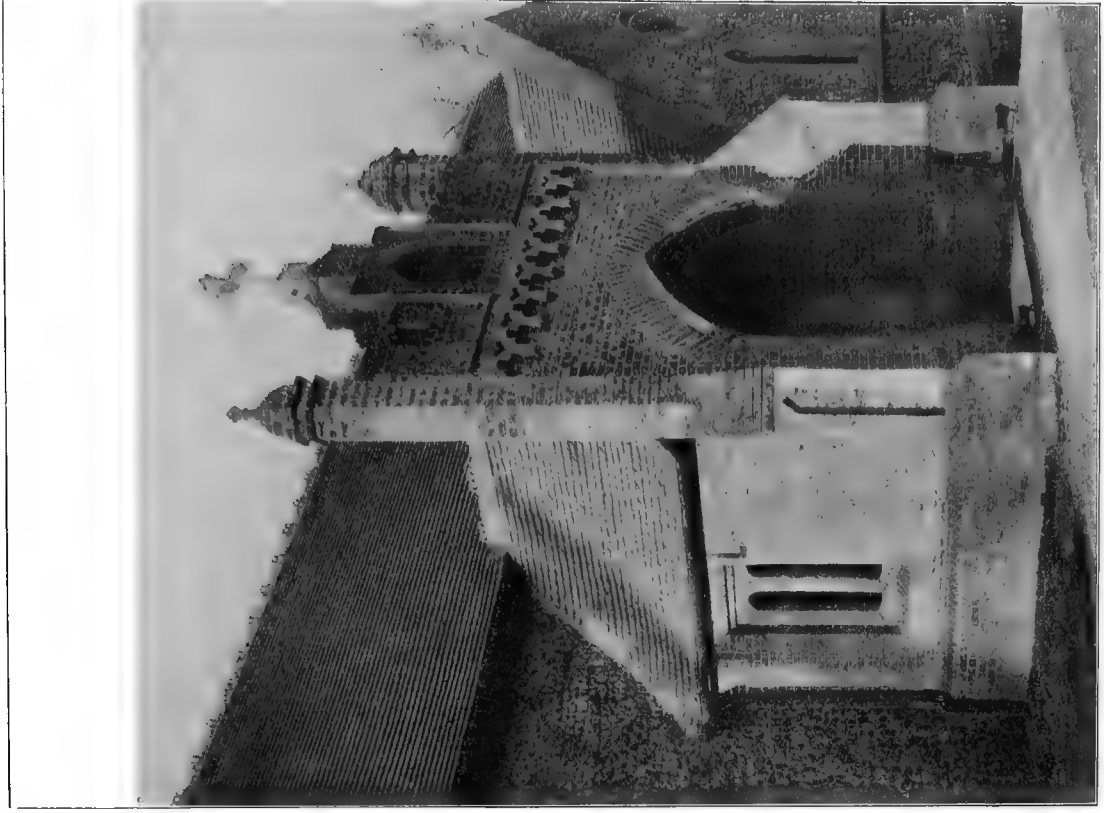

MEESDEN CHURCH : THE SOUTH PORCH

Wyntonesfield and Coldsinethescroft.⁸ Peppercorn appears as the name of a family of villein tenants on the manor in the 15th century,⁹ and in 1570 there was a house called Peppercorns in the parish in which Andrew Kyng of Meesden, yeoman, lived.¹⁰

Before the Conquest *MEESDEN* was *MANOR* held by Alward, a man of Archbishop Stigand. It was one of the manors acquired under William I by the Bishop of London, of whom it was held in 1086 by a tenant Payn.¹¹ It was then assessed for 1 hide and comprised land for five ploughs.¹²

As one of the Bishop of London's manors Meesden formed part of the barony of Bishop's Stortford and paid a rent of 2s. to the castle there.¹³ The Bishop of London claimed quittance of suit of hundred court for his men and their tenants at Meesden before the justices of Edward I.¹⁴

Payn's immediate successors are unknown, but at the beginning of the 13th century Aubrey de Vere Earl of Oxford was holding Meesden as half a knight's fee of the bishop.¹⁵ In the middle of the same century the manor was held under the Earl of Oxford by a sub-tenant, the mesne lordship thenceforward descending with the successive Earls of Oxford.¹⁶ These earls seem to have been peculiarly tenacious of their feudal rights of overlordship.¹⁷ A letter from John de Vere Earl of Oxford to the Abbot of St. Mary Graces, tenant of the manor, in 1514 reminds the abbot that he owes the service of a knight's fee and relief of 100s. for his lands in Meesden and summons him to appear at the earl's castle of Hedingham at the following Easter, threatening the penalty of the law should he fail to appear.¹⁸ As late as 1634 a return of knights' fees held of Robert Earl of Oxford was made, Meesden being among the number.¹⁹ Between the Earls of Oxford and the immediate tenant of the manor there seems to have been a further mesne tenancy held by the family of Gedding. What interest they had in the manor or how they acquired it is not clear. In a fine of the manor levied in 1265 it is recorded that Maud widow of Henry le Eveske and Richard son of William de Gedding 'put in their claim.'²⁰ In 1304 the manor was said to be held of Robert de Gedding.²¹ These rights over the manor, whatever they were, were remitted by Sir John de Gedding to the Abbot of St. Mary Graces in 1383.²²

In 1253 the immediate tenant of the manor was Robert le Botiller, who in that year received a grant of free warren.²³ Robert le Botiller died seised of the manor in 1262, when Richard le Botiller his brother succeeded. The extent of the manor then included a windmill.²⁴ In 1265 Richard le Botiller conveyed Meesden to Denise de Monchensey,²⁵ widow of his brother Robert.²⁶ The manor descended with the heirs of Denise de Monchensey in the same way as the manor of Anstey (q.v.) to Aymer de Valence Earl of Pembroke,²⁷ and in 1325 was granted for life to his widow Mary Countess of Pembroke, with remainder to her heir Laurence de Hastings.²⁸ In 1368 the countess had licence to grant the reversion of this manor with that of Little Hormead and Westmill to a Carthusian monastery to be founded in one of them.²⁹ With the same manors the reversion of Meesden was finally granted by Letters Patent to the abbey of St. Mary Graces in 1376.³⁰

The manor remained with the abbey until the Dissolution.³¹ In 1543 it was granted to John Gates of Garnets in High Easter, co. Essex, together with woods of 33 acres called Hall Wood Coppice and Small Wood Coppice.³² The grantee was the Sir John Gates who in 1553 was beheaded as a supporter of Lady Jane Grey,^{32a} but the manor was probably sold by him before this date to William Bradbury, who in 1550 bought the manor of Langley in Clavering, co. Essex, from him.³³ William Bradbury died seised in 1550, his son Robert being his heir.³⁴ Robert died in January 1576-7.³⁵ The manor descended to his brother Henry and on Henry's death in February 1596-7³⁶ to his son William. In 1601 William Bradbury of Littlebury and Margaret his wife conveyed the manor to Richard and Anthony Luther.³⁷ The Luthers were a family who held considerable estates in Essex, but there seem to have been several branches of the family in which the same Christian names constantly recur, which makes their pedigree difficult to trace.³⁸ Chauncy states that Richard Luther was succeeded by a son and heir Thomas,

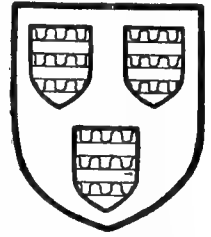

MONCHENSEY. Or three scutcheons barry vair and gules.

⁸ Mins. Accts. bdle. 867, no. 6, 7; Harl. Roll N 18; Rentals and Surv. portf. 8, no. 33.

⁹ Ct. R. (Gen. Ser.), portf. 178, no. 2, 3.

¹⁰ Will printed in *Herts. Gen. and Antiq.* i, 36. Wills of other inhabitants are printed in *ibid.* i, 369, 374; ii, 9, 10.

¹¹ *V.C.H. Herts.* i, 307b.

¹² *Ibid.* The difference between the hidage and the possible extent of arable here is probably accounted for by the large amount of woodland.

¹³ Mins. Accts. bdle. 867, no. 5, 6; Chan. Inq. a.q.d. file 365, no. 18.

¹⁴ *Plac. de Quo Warr.* (Rec. Com.), 290.

¹⁵ *Red Bk. of Exch.* (Rolls Ser.), ii, 541.

¹⁶ Chan. Inq. p.m. 35 Hen. III, no. 32; Ct. R. (Gen. Ser.), bdle. 177, no. 36, and below.

¹⁷ In several other cases (see Little Hormead in Edwinstree), and perhaps in this case also, the mesne lordship of the Earls of Oxford was not acquired in the usual way by virtue of a grant from

a tenant above and of a grant to a tenant below, but was a tenancy acquired in between an overlord and a tenant already holding.

¹⁸ *L. and P. Hen. VIII*, i, 4766 (printed in full by Cussans, op. cit. *Edwinstree Hund.* 131).

¹⁹ Chan. Inq. p.m. (Ser. 2), ccclxxiii, 15.
²⁰ Feet of F. Herts. 49 Hen. III, no. 578.

²¹ *Abbrev. Plac.* (Rec. Com.), 252.

²² Close, 6 Ric. II, pt. ii, m. 16 d.

²³ Anct. D. (P.R.O.), A 5446.

²⁴ Chan. Inq. p.m. 47 Hen. III, no. 14. Richard is called son of Robert le Botiller in Assize R. 325.

²⁵ Feet of F. Herts. 49 Hen. III, no. 578.

²⁶ See Little Hormead.

²⁷ See *Abbrev. Plac.* (Rec. Com.), 252; Feet of F. Div. Co. 1 Edw. II, no. 4.

²⁸ *Cal. Pat.* 1324-7, p. 153.

²⁹ Inq. a.q.d. file 365, no. 18.

³⁰ Pat. 50 Edw. III, pt. ii, m. 16; see

Chan. Inq. p.m. 51 Edw. III (1st nos.), no. 28; *Feud. Aids*, ii, 446; *Cal. Papal Letters*, v, 547; *Cal. Pat.* 1461-7, p. 162.

³¹ *Valor Eccl.* (Rec. Com.), i, 398. At the time of the Dissolution it was leased to John Hagar of Clavering, yeoman (Aug. Off. Decr. xi, 86).

³² *L. and P. Hen. VIII*, xviii (2), 327 (11).
^{32a} *Dict. Nat. Biog.*

³³ Morant, *Hist. of Essex*, i, 614.

³⁴ Chan. Inq. p.m. (Ser. 2), xc, 123.

³⁵ *Ibid.* clxxvii, 54.

³⁶ *Ibid.* cxlix, 54.

³⁷ Feet of F. Herts. Mich. 43 & 44 Eliz.; Hil. 44 Eliz.; Feet of F. Div. Co. Hil. 7 Jas. I.

³⁸ cf. Morant, *Hist. of Essex*, i, 186; ii, 191; *Visit. of Essex* (Harl. Soc.), i, 439. None of these branches seem to correspond with the Hertfordshire one. Langley in Clavering was held by the Luthers who held Meesden (Morant, op. cit. i, 614), but the Essex historian has not traced their pedigree.

A HISTORY OF HERTFORDSHIRE

but in 1610 Anthony Luther with Thomas Luther received a quitclaim of the manor from Francis Joselyne and his wife Margaret³⁹ (probably widow of William Bradbury), and in 1643 Thomas Luther died seised of the reversion of the manor after the death of Bridget Luther,⁴⁰ who in 1662 presented to the church as Bridget Herys, widow of Anthony Luther.⁴¹ It therefore seems probable that the Anthony whom Chauncy gives as the son of Thomas was in reality his father. Thomas was succeeded by his brother Anthony. This Anthony seems to be the Anthony Luther, junior, who in 1651 took part with his wife Dorothy in a settlement of the manor, the other parties being Edward Herys and his wife Bridget, Anthony Luther, senior, and Thomas Luther.⁴² In 1674 Anthony Luther presented to the church and in 1694 Dorothy Luther, widow.⁴³ In 1711 another Anthony Luther presented,⁴⁴ and it was this Anthony apparently who sold the manor in 1730 to Jacob Houblon.⁴⁵

Jacob Houblon settled Meesden in 1758 on his eldest son Jacob,⁴⁶ who married Susanna Archer.⁴⁷ Their son John Archer Houblon⁴⁸ sold the manor in 1801-2 to Samuel Robert Gausson of Brookman Park in North Mimms.⁴⁹ It was bought about 1814 by his brother the Rev. Armytage Gausson,⁵⁰ who died without issue in 1859, leaving the manor to his wife Sarah Elizabeth Gausson. After her death in 1865 the manor was sold by her executors to Baron Charles John Dimsdale of Essendon,⁵¹ and is now held by his grandson Baron Charles Robert Southwell Dimsdale.

The priory of St. Bartholomew, Smithfield, had a small estate in Meesden.⁵² The prior is called rector of the church in 1509,⁵³ probably by virtue of a lease of the rectory from the Abbot of St. Mary Graces.

Some detailed extents of the manor of Meesden for the 14th century and later still remain and illustrate fully its domestic economy.⁵⁴ Among the profits of the manor in the 14th century were those from the sale of underwood in Smaley Wood, of pasture on the 'hedge rows' of the common fields and of the millere of the mill. The custom called 'schereneschot' amounted to 3s. 4d. in 1346.⁵⁵

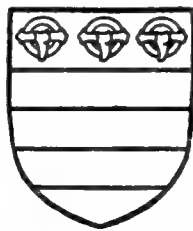

LUTHER. *Argent two bars sable with three round buckles azure in the chief.*

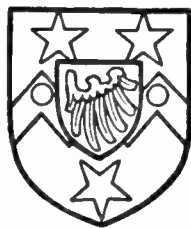

DIMSDALE. *Argent a fesse dancetty azure between three molets sable with three bezants on the fesse and the augmentation of a scutcheon or with an eagle's wing sable.*

Besides the home farm (*grangium*) the lord held shots in the common fields, one of which, Valencesrode in Houndsdichfield, preserved the name of the Earls of Pembroke.⁵⁶ In the 15th century several 'molmen' are mentioned among the tenants of the manor.⁵⁷

The church of *ST. MARY* stands *CHURCH* about half a mile east of Meesden Green and consists of chancel 20 ft. 6 in. by 15 ft. 6 in., nave 40 ft. 6 in. by 15 ft. 6 in., small north and south transepts each 13 ft. wide by 6 ft. 6 in. deep, south porch 8 ft. 3 in. square and wooden bellcote over the western end of the nave; all the dimensions are internal.

The walls are of flint rubble with stone dressings; the porch is built of brick; the roofs are tiled. The nave belongs to the early part of the 12th century; the chancel and transepts date from about 1270-80. The transepts were subsequently pulled down and the arcades filled in. In 1876 the transepts were rebuilt on the old foundations and the arcades reopened. The south porch was added about the middle of the 16th century. Much of the external stonework is modern, as is also the wooden bellcote.

The east window of the chancel is of three cusped lights under a pointed head; the moulded inner jambs and arch are original, but all the outer stonework is modern. The north and south walls have each a window of two lights, the outer stonework of which is modern, but the inner jambs and arch are similar to the east window. In the south wall is a piscina with a pointed trefoil head, the edges of which are moulded with a filleted hollow, with moulded stops on the jambs; the drain is eight-foiled. Adjoining the piscina is a single trefoil-headed sedile with similar detail; they are both of 1270-80. There is no chancel arch.

In the north wall of the nave are two traceried windows, each of two lights and all of modern stonework. In the south wall is one similar window, but with inner jambs and moulded rear arch of 15th-century date. At the east end of the nave walls, on the north and south sides, are the late 13th-century arcades to the small transepts; they are of clunch, and each consists of two bays with a width of about 4 ft. between the piers. The arches are of two moulded orders, the mouldings being filleted hollows similar to the piscina and sedile; there is a moulded label next the nave with mask stops. The piers are octagonal with moulded capitals and bases. The south doorway is of 12th-century date with plain flattened semicircular arch and square jambs; the abaci are hollow-chamfered; the doorway is of oolite. The 14th-century west doorway is of Barnack stone with pointed arch and moulded label; arch and jambs are chamfered. The west window is of two traceried lights of modern stonework. The south porch is built of 2-in. red bricks; the entrance archway is four-centred with a moulded label. The arch is of two continuous orders formed of square

³⁹ Feet of F. Div. Co. Hil. 7 Jas. I.

⁴⁰ Chan. Inq. p.m. (Ser. 2), dccxliv, 43.

⁴¹ Cussans, op. cit. 133.

⁴² Feet of F. Div. Co. Hil. 1651.

⁴³ Inst. Bks. (P.R.O.).

⁴⁴ Ibid.

⁴⁵ Feet of F. Herts. Mich. 4 Geo. II.

⁴⁶ Com. Pleas D. Enr. East. 31 Geo. II, m. 124.

⁴⁷ Berry, *Essex Gen.* 163, 164.

⁴⁸ See *Recov. R. Trin.* 37 Geo. III, rot. 159.

⁴⁹ Cussans, op. cit. 131.

⁵⁰ Clutterbuck, *Hist. and Antiq. of Herts.* iii, 439.

⁵¹ Cussans, loc. cit.

⁵² *Pope Nich. Tax.* (Rec. Com.), 15a.

⁵³ Harl. Roll N. 18 (Court held 1 Hen. VIII).

⁵⁴ See *Mins. Accts. bdl.* 86-, no. 4-9;

Rentals and Surv. portf. 8, no. 33; *Ct. R. (Gen. Ser.)*, portf. 178, no. 1-3.

⁵⁵ *Mins. Accts. bdl.* 86-, no. 4-9.

⁵⁶ *Rentals and Surv. portf.* 8, no. 33. In Millfield the lord had Madsot and Eidewellshot (*Mins. Accts. bdl.* 867, no. 6).

⁵⁷ *Mins. Accts. bdl.* 867, no. 7. The works of the tenants are here given in detail.

oversailing courses of brickwork; at the angles are diagonal buttresses, on which are set lofty hexagonal turrets with ogee heads. Over the archway is a brick corbel table of cusped arches, above which is an embattled parapet, the central part of which is stepped and contains a shallow niche with pointed arch; in the niche is set a small brick star in a circle and beneath are bricks with cusped circles and other devices. In the face of each buttress is a shallow trefoil-headed niche; in the east and west walls are two-light windows with square labels over. In the north-east angle is a rough cavity which contained a stoup.

The stone font is of 17th-century date; it is octagonal with panelled and moulded bowl and stem.

Surrounding the communion table is a very interesting pavement of glazed tiles; it has a width of 9 ft. 8 in. and projects 7 ft. from the east wall. The space under the communion table is not tiled. A few of the tiles of each colour used in the design—dark green, brown and yellow—are in a perfect state, but most of the tiling is much worn. A wide outer border, consisting chiefly of circles conjoined, is the principal feature of the design, but within is part of a large circular pattern with tiles radiating to a centre. Many of the tiles forming the border have conventional flowers stamped on them, the sunk outlines of which are sharp and clean cut; in the central part the stamped ornaments consist of circles containing two birds face to face and various geometrical figures. In each of the two spandrels at the angles is a roughly executed shield of arms, apparently one of the little scutcheons—barry vair and gules—from the arms of the Monchensey family, a member of

which held the manor at the end of the 13th century. The tiles date from about 1300.

On the north wall of the chancel is a mural monument to Robert Younge, 1626. His bust is in a niche and above are his arms.

There are two bells: the first is marked 'C. G. 1666'; second, blank.

The communion plate consists of a cup and standing paten, 1621.

The registers before 1812 are as follows: (i) baptisms and burials 1737 to 1812; (ii) marriages 1797 to 1812.

The advowson of Meesden Church *ADVOUSON* followed the descent of the manor⁵⁸ until the death of Mrs. Gaussen in 1865. It then came by will to her nephew Mr. W. G. Whatman,⁵⁹ and is now held by Mr. Pembroke S. Stephens, K.C. The living remained a rectory after the acquisition of the manor by St. Mary Graces, no appropriation being made by the abbey. The church was a valuable one for so small a place. In 1535 it was assessed at £12,⁶⁰ and a return of 100 acres of glebe belonging to it was made in 1610.⁶¹

In 1663 Edward Younge, D.D., *CHARITIES* dean of the cathedral church of St. Peter, Exeter, by his will gave 20s. a year to the poor of this parish. In the result of certain proceedings in Chancery a close containing 1 a. 1 r., known as the Town Close, was purchased and conveyed by deed, 23 May 1693, to trustees for the poor.

The close is let at £2 15s. a year, which, less land tax, is distributed among the poor on or about 29 May in each year.

BRENT PELHAM

Pelham de Sarneris (xii cent.); Pelham Arsa, Pelham la Arse, Barndepelham, Brende Pelham (xiii, xiv and xv cent.); Pelham Combusta, Brent Pelham, Burnt Pelham (xvi, xvii, xviii cent.); Pelham Sarners¹ (xviii cent.).

The parish of Brent Pelham has an area of 1,636½ acres, of which rather more than half is arable land.² The altitude varies from 300 ft. to 450 ft., reaching its lowest point in the southern part of the parish beside the banks of the River Ash and its highest near the north-western boundary. The soil is heavy and the subsoil clay.

At a point midway in the southern boundary of this parish the road which connects Furneux Pelham parish with the Hadham road divides into two, one of which leads through Brent Pelham and to the north-east into Essex and has on its north side, not far from the Essex boundary, the house called Beeches, now occupied by the farm bailiff to Mr. E. E. Barclay. It is a timber-framed and plastered house with tiled roofs. The walls are on foundations of thin 2-in. bricks; the chimney stacks are

also of thin bricks. The house, it is said by Chauncy,³ was built by Philip Allington, who died in 1595, but there appear to have been considerable alterations during the latter part of the 17th century and also in the 19th century. The plan was originally L-shaped. The main block faces south-west, and the wing at its south-east end, projecting north-east, contains the kitchen offices; at the re-entering angle is a square newel staircase inclosed with timber-framing and weather-boarded. At the other end of the main block is a short wing which was probably added later in the 17th century; originally it was much longer, but many years ago some six rooms at the end were demolished, tradition says because they were haunted. It now contains a stair to the first floor and has a cellar beneath; a modern brick passage, on the ground floor only, connects this wing with the main entrance lobby about the middle of the main block. At each end of the main block is a projecting chimney stack with a row of three plain octagonal shafts with moulded bases; the capitals have corbelled projections making them star-shaped on plan. About the centre

⁵⁸ Chan. Inq. p.m. 47 Hen. III, no. 14; Feet of F. Herts. 49 Hen. III, no. 578; Div. Co. 1 Edw. II, no. 4; Chan. Inq. a.q.d. file 365, no. 18 (42 Edw. III); list of patrons given by Cussans, op. cit. *Edwinstree Hund.* 133; Newcourt, *Repert.* i, 847.

⁵⁹ Cussans, op. cit. *Edwinstree Hund.* 132.

⁶⁰ *Valor Eccl.* (Rec. Com.), i, 452.

⁶¹ Terrier quoted by Newcourt, *Repert.* i, 847.

¹ The present name of the parish, which occurs as early as 1230 (*Cal. Pat.* 1225-32, p. 368), is traditionally derived from a fire which took place in the reign of Henry I (*Home Cos. Mag.* [1902], iv,

289). 'Some fragments do yet appear,' wrote Norden in 1593, 'of the foundations of sundry buildings which were consumed by that fire, whereof it taketh the adjunct *arsa*' (Norden, *Speculum Brit.* 21).

² Statistics from Bd. of Agric. (1905).

³ Chauncy, *Hist. Antiq. of Herts.* 142.

A HISTORY OF HERTFORDSHIRE

of the main block a similar chimney stack projects at the back. Against the south-east side of the wing is a wide projecting stack from the kitchen fireplace; it has sloping offsets masked in front by stepped brickwork. The head is plain. The main entrance is near the centre of the south-west front, and the rooms at each end have splayed bay windows on the ground floor only, probably of late 17th-century date. The external plaster work is ornamented with flush-bead panels filled with late 17th-century combed work of different patterns, but patched and in poor condition. The original hall was in the centre of the main block; the stone fireplace has been removed to Brent Pelham Hall, together with a quantity of oak panelling from two of the bedrooms and a room, now the parlour, at the south-east end of the main front. This room retains a mid-17th-century plaster ceiling,

and under the collars of the roof; the sloping part was formerly decorated with moulded plaster ribs forming a pattern of large hexagons with plaster roses where the ribs crossed, portions of which remain.

In 1595 the capital messuage or farm called Shonk in Brent Pelham was held with Beeches Manor.⁴ Chauncy in 1700 describes 'an old decayed house well moated . . . called O Piers Shonks,'⁵ and in 1743 an old moated barn known as Shonks Barn stood near Beeches Manor House, but was 'in a very tottering condition,'⁶ and a neighbouring wood was called Shonks Wood,⁷ now apparently Beeches Wood. Shonks Moats can still be seen near Beeches House about a mile to the south-east of Brent Pelham Church and inclose two islands. Popular tradition connects these place-names with a tomb in the church, which an 18th-century inscription ascribes to O Piers Shonks, who died in 1086. But the tomb dates only from the late 13th century.⁸ The name Shonks has been more plausibly derived from the early tenancy of Gilbert Sanke (see below under manor of Beeches) or others of his family, of whom may have been Matthew Shanke⁹ and William Shanke of Pelham,¹⁰ who occur in 1324 and 1353 respectively, and Peter Shank, who later in the century was lessee of the manor of Barwick in Barkway¹¹ (q.v.).

The second road into which the Furneux Pelham road divides leads north and north-west through Brent Pelham village, at a point beyond which it also divides, one road going to Meesden parish, with Chamberlain's Moat (probably marking the site of the old manor-house of Chamberleyns) on its west side, and the other by a winding route to Anstey. The buildings which form the village lie somewhat scattered; several new dwellings have been erected by the present owner. In the village are the kennels of the Puckeridge Foxhounds. The church is in the middle of the village and the stocks and whipping-post are by the south gate: the iron wrist holders of the latter, fastened with padlocks, still remain.

To the east of the church is Brent Pelham Hall, the manor-house, the residence of Mr. E. E. Barclay, lord of the manor. It is of two stories with attics and has tiled roofs. A lintel dated 1608 is over one of the doors in the wall of the garden, and the house was probably erected at that date. It was originally a timber-framed building, but was encased in brick towards the end of the 17th century. The plan was roughly L-shaped; the main block, about 80 ft. in length, faces west, and at its south end is a wing projecting eastwards; there is a modern north wing. At each end of the west front is a slightly projecting wing with hipped roof, and in the centre is a bay of still less projection with pediment over; in the centre is a porch. The view of the house (1698) given by Chauncy is practically identical with the present view of the front. Moulded modillion cornices of wood are carried round the eaves and pediment. The level of the first floor is marked by a plain brick string-course. In the centre of the pediment is an oval sunk panel.

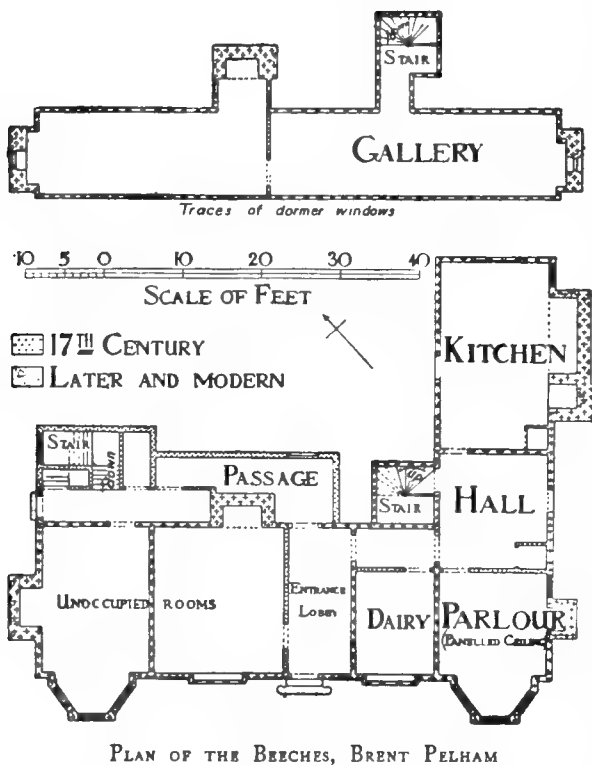

the moulded ribs of which form a square and hexagonal pattern; the ceiling goes into the bay window. The wide kitchen fireplace has a three-centred arch, partly blocked; there is a small cellar under the kitchen. On the first floor is a stone fireplace with four-centred arch and frieze carved with roses and leaves; it is of mid-17th-century date. The attic floor over the main block is one long gallery the whole length of the building; it is 66 ft. long by 10 ft. 6 in. wide, and is now lighted only by a small brick-mullioned window pierced through the chimney stack at each end. Near the centre, in a recess, is a stone fireplace with splayed four-centred arch. The gallery was formerly lighted by dormers on both sides, traces of which still remain. It is ceiled on the sloping rafters

⁴ Chan. Inq. p.m. (Ser. 2), ccxliii, 71.

⁵ Chauncy, *Hist. Antiq. of Herts.* 143.

⁶ Add. MS. 5806, fol. 18.

⁷ *Ibid.* fol. 19.

⁸ *Hist. Monum. Com. Rep. Herts.* 70.

⁹ *Cal. Pat.* 1324-7, p. 38.

¹⁰ *Cal. Close*, 1349-54, p. 523.

¹¹ *Cal. Pat.* 1396-9, p. 578. There was also a family of Knightsbank in Barkway. See p. 27.

EDWINSTREE HUNDRED

BRENT PELHAM

The front of the porch is modern. All the windows have flush moulded frames without brick reveals. The chimney stacks belong to the original house of 1608 and are built of thin bricks. On the south wing is a group of four detached plain octagonal shafts standing on a square base; the bases are moulded. At the north end is a projecting stack with two similar shafts. About midway between is a stack with two circular shafts with moulded capitals and bases; one of these is ornamented with fish-scale pattern, the other with a chevron. The interior has been much altered and added to, but the old hall still remains; it occupies the whole of the front between the wings. The hall has a stone fireplace with moulded four-centred arch and an early 17th-century oak mantelpiece. The panelling on these walls and also on those of the dining room is of the same date. In the dining room, north of the hall, is a late 17th-century stone fireplace bearing the Floyer arms. There are several other stone fireplaces in the house made of clunch, two of them brought a few years ago from Beeches. One of these, now in the study, is of mid-17th-century date and has a four-sided moulded arch with carved spandrels and a frieze above carved with roses and other flowers. The arch, like the fireplaces at Queenhoo Hall, Tewin, is formed of four straight lines instead of segments of circles. On the stairs at the north end of the house are the arms of Floyer impaling Boothby. In an ante-room at the south end of the house and also in the study and one of the bedrooms is a quantity of mid-17th-century oak panelling brought from Beeches.

A large number of fragments of Roman pottery have been dug up from time to time in the fields surrounding the house; many of these are preserved at the Hall, including a perfect specimen of a large Roman water-jug.

The Bury, now a farm-house, stands in the village north of the church; it is a T-shaped building of early 17th-century date. The roofs are tiled. The house has been much modernized; it is of two stories. There are two chimney stacks of thin brick on the roofs with square shafts set diagonally on sloping bases; they have been partly rebuilt. Over the back door is the date 1677 moulded in the plaster.

Near Cole Green is a moated tumulus.

Of the inhabitants of the parish Francis Young gained some distinction by the dedication to him in 1602 of Anthony Munday's *Palmerin of England*.¹² The divine Charles Wheatley was instituted to the vicarage in March 1726, but transferred in April to Furneux Pelham.¹³

Place-names which occur in Brent Pelham are Bradecompe,¹⁴ Burstouwe,¹⁵ Fleslond, Bedewelle and Presteslond¹⁶ (xiii cent.); Boyle and Newclose,¹⁷ both field-names (xvi cent.).

There is in the Domesday Survey no *MANORS* distinction between the three Pelhams.

All the lands in them are described as in Pelham, with the exception of one holding said to be in Hixham, a manor included in what became Furneux Pelham. The Survey makes mention of 13 hides and 3 virgates of land in the Pelhams, divided into eight holdings. Of these, three, con-

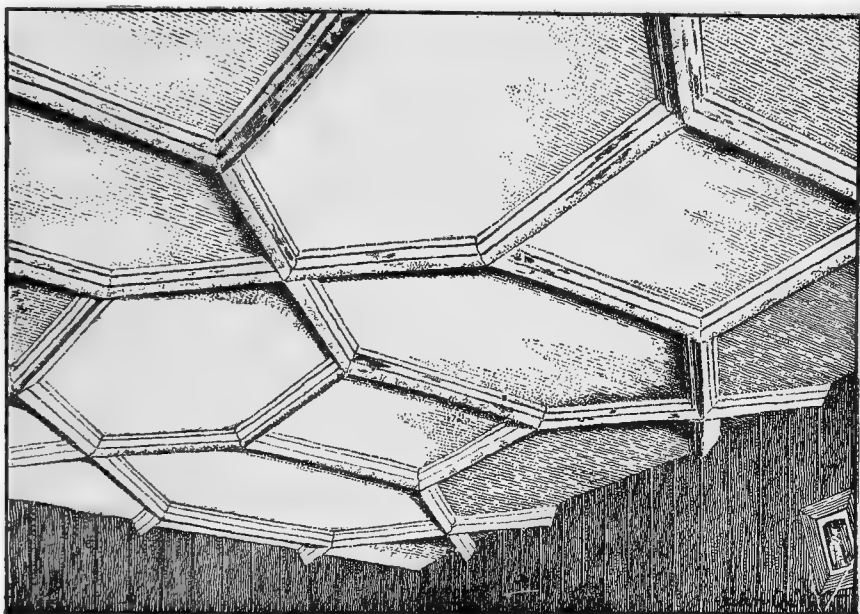

THE BEECHES, BRENT PELHAM: CEILING OF PARLOUR

taining in all 3 hides and 3 virgates, were held by men of Asgar the Staller, probably identical with the Sheriff of Middlesex who was prominent in the defence of London against William I.¹⁸ A fourth holding, having a hide and a virgate of land, had two tenants, a man of Asgar and a man of the Abbot of Ely. Two more, of which the total assessment was 3 hides, were in the tenure of men of Godwin of Bendfield; and of the two remaining, one, which had 2½ hides, was held by a man of Godwin and a man of Anschil of Ware, and the other, assessed at 3 hides 1 virgate, by a thegn who was Anschil's man and a thegn of Ælmar of Benington, together with five sokemen of the king who held 5 virgates. Thus the tenants of the Pelhams in Anglo-Saxon times owed allegiance to six overlords, including the king. In 1086 all their territory was held of the Bishop of

¹² *Dict. Nat. Biog.* See under Bartholomew Young.

¹³ *Ibid.*

¹⁴ Add. MS. 5806, fol. 23 d.

¹⁵ *Ibid.* fol. 15 d.

¹⁶ Doc. of D. and C. of St. Paul's, W.D. 16, Liber i.

¹⁷ Chan. Proc (Ser. 2), bde. 192, no. 49.

¹⁸ Freeman, *Norman Conquest*, ii, 424, 501, 525, 544, 729.

A HISTORY OF HERTFORDSHIRE

London. The mesne tenants were changed in number in three cases : a holding of 1 hide 1 virgate, held formerly by two brothers, men of Asgar, had only one tenant ; another of 1½ hides, which one man of his had held, had passed to William and Ranulf ; and that holding which had been in the tenure of men of Anschil and Godwin was held by Ranulf only. Moreover the five sokemen of the king had disappeared. The two thegns of Anschil and of Ælmar had given place to two knights.¹⁹ All the three Pelhams continued to be held of the Bishops of London.

The division between them was probably established in the 12th century. There is separate evidence of Brent and Furneux Pelham in 1181,²⁰ of Stocking Pelham in 1278.²¹

was said to hold of the bishop half a knight's fee in the parish.²⁶ He may be identified with a Nicholas le Grey who made his will in 1334²⁷ and who was succeeded before 1363 by Thomas le Grey. The latter with his wife Agnes at this date settled his manor of Brent Pelham on himself and his heirs by Agnes.²⁸ He still held in 1373,²⁹ but in 1378 the manor had passed to John Grey,³⁰ probably his son, who in 1405³¹ settled it on himself and his wife Joan in tail. In 1418³² and 1428³³ Joan was sole tenant. She was succeeded, according to the settlement, by her son Ralph, who was knighted and who died in 1464, leaving a son and heir Ralph.³⁴ The latter, who was one of the barons of the Exchequer, died in 1492 and left a daughter and heiress Elizabeth,³⁵ who married Anthony Waldegrave or Walgrave,

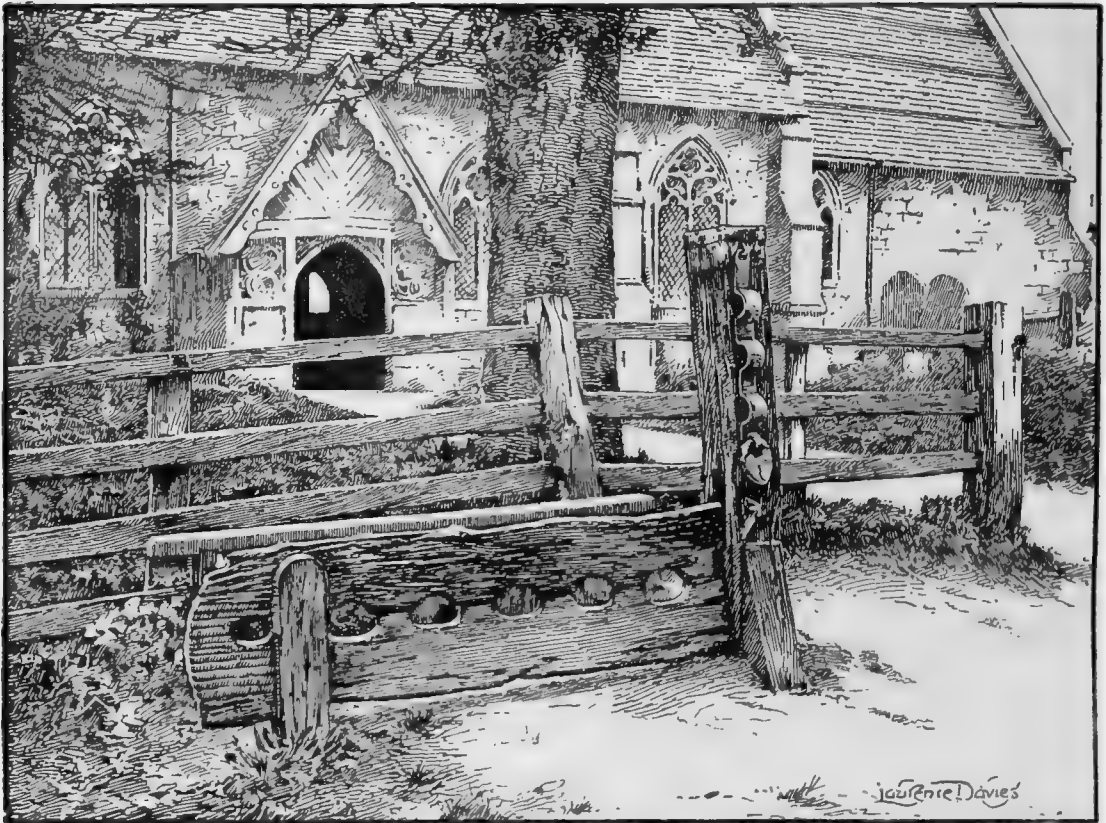

THE STOCKS, BRENT PELHAM

Between 1210 and 1212 Richard le Grey held part of a knight's fee of the Bishop of London, evidently the manor of BRENT PELHAM or GREYS,²² and about the year 1230 he again occurs as a tenant in the parish.²³ His probable successor was Nicholas le Grey, who in 1254 received a grant of free warren in Brent Pelham.²⁴ This Nicholas was probably father to Nicholas grandson of Richard le Grey, who was tenant of the manor in 1278²⁵ and who in 1303

of the Friars in Buers, Suffolk. The eldest son of Anthony and Elizabeth was William,³⁶ who in 1556 conveyed the manor and lands in Brent Pelham and Stocking Pelham³⁷ to trustees for the use of himself and his wife Katherine for their lives with power of appointment. The reversion of the mansion-house or manor-place, with its closes and 24 acres of arable land, meadows, pasture and wood, was settled separately after the deaths of William and Katherine upon

¹⁹ *V.C.H. Herts.* i, 288, 307a, 307b.

²⁰ *Newcourt, Repert.* i, 852, 854.

²¹ *Assize R.* 323.

²² *Red Bk. of Exch.* (Rolls Ser.), 541.

²³ *Add. MS.* 5806, fol. 23 d.

²⁴ *Cal. Pat.* 1247-58, p. 318.

²⁵ *Herts. and Hants Assize R.* Edw. I (Agarde's Index), fol. 45 d.

²⁶ *Feud. Aids*, ii, 431.

²⁷ *Hist. MSS. Com. Rep.* ix, App. i, 46b.

²⁸ Feet of F. Herts. 37 Edw. III, no. 523.

²⁹ *Cal. Close*, 1369-74, p. 587.

³⁰ *Cal. Pat.* 1377-81, p. 219; *Close*, 3 Ric. II, m. 20 d.

³¹ Feet of F. Herts. 7 Hen. IV, no. 34.

³² *Chan. Inq. p.m.* 7 Hen. V, no. 37b.

³³ *Feud. Aids*, ii, 446.

³⁴ *Chan. Inq. p.m.* 5 Edw. IV, no. 27.

³⁵ *Ibid.* (Ser. 2), xii, 108.

³⁶ *Visit. of Essex* (Harl. Soc.), i, 515.

³⁷ Some of this land belonged to Chamberleyns Manor.

EDWINSTREE HUNDRED

BRENT PELHAM

their daughters Elizabeth and Margaret for their lives.³⁸ Katherine after the death of William married John Brooke, with whom she held the manor.³⁹ In 1563 it was conveyed by Katherine, William Walgrave her son, and Margaret her daughter to Henry Parker Lord Morley.⁴⁰ Brent Pelham Manor afterwards passed for some years with that of Furneux Pelham⁴¹ (q.v.), being acquired by Edward Newport in 1597.⁴²

By Newport's son and heir John the manor was sold to Francis Floyer,⁴³ a Turkey merchant, who, being elected Sheriff and Alderman of London, submitted to a fine that he might retire to this property. Here he occupied himself with the improvement of the manor-house until 'nothing was wanting to make it pleasant and delightful.'⁴⁴ He was High Sheriff of Hertfordshire in 1648⁴⁵ and died in 1678. 'He was very grave in his Deportment, reserved in his Discourse, excellent at accounts in Merchandise, punctual to his Word and just in his Dealings, which gave him a great Reputation. He loved Hospitality, was noble in Entertainments, bountiful to Strangers, and liberal to the Poor. He was very strict in all his Acts of Religion, always valuing a clergyman by the severity of his Duty and the rules of his Life. He observed an excellent Method for the Government of his Family, and kept great order in this parish.'^{45a} His grandson Francis, son of Thomas Floyer, succeeded him and became a captain of the militia in 1685-6, sheriff of the county in the following year and a justice of the peace in 1688-9.⁴⁶ At his death in 1722 the manor passed to his second son Thomas, who died in 1743⁴⁷ and left a daughter and heiress Mary. The sisters of Thomas, Elizabeth wife of John Gibbs, grocer of London, Anne wife of Angel Chauncy, clerk, and Judith and Katherine Floyer, settled the manor in 1746.⁴⁸ Mary Floyer married Thomas Halden,⁴⁹ with whom she held the manor in 1767.⁵⁰ She died in 1773.⁵¹ The

manor was held by her descendants⁵² until 1839 when after the death of John Halden it was sold to George Hallam of Whitebarns in Furneux Pelham. On the death in 1859 of the latter's son and heir, George Walsh Hallam, it was bought by William Heygate, who sold it in 1865 to Joseph Gurney Barclay of Leyton in Essex,⁵³ whose son Mr. Edward Exton Barclay, M.A., J.P., M.F.H., is the present lord.

CHAMBERLEYNs. — In 1181 Brent Pelham parish is called Pelham of W. de Sarneniis,⁵⁴ and between 1210 and 1212 Robert le Sarneres held of the bishop with Richard le Grey one knight's fee, in which it is

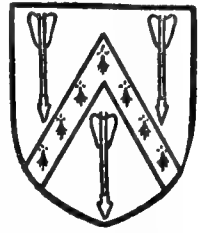

FLOYER. *Sable a chevron ermine between three arrows argent.*

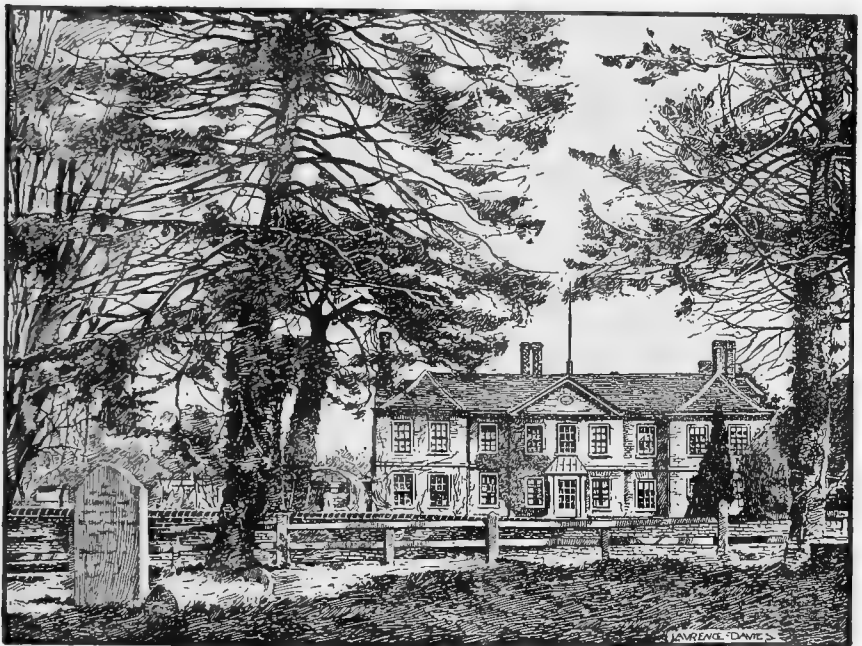

BRENT PELHAM HALL : WEST FRONT

evident that the two manors of Brent Pelham were included.⁵⁵ Another member of this family may have been Geoffrey Sarvors or Sarnors, who before 1252 endowed the lights of the church.⁵⁶ In the first half of the 13th century, however, the rights of the Sarners family passed to the family of Chamberleyn, who possibly were descended from the ancient holders but had acquired a new surname in right of an office held by one of their number. The first of

Footnote 38: Feet of F. Herts. Trin. 2 & 3 Phil. and Mary; Recov. R. Trin. 2 & 3 Phil. and Mary, rot. 432; Chan. Proc. (Ser. 2), bdle. 192, no. 49.

Footnote 39: Chan. Proc. (Ser. 2), bdle. 7, no. 11; Star Chamb. Proc. Hen. VIII, bdle. 20, no. 169, 353.

Footnote 40: Feet of F. Herts. East. 5 Eliz.; Recov. R. Hil. 5 Eliz. rot. 503.

Footnote 41: Recov. R. East. 25 Eliz. rot. 87; Trin. 25 Eliz. rot. 157.

Footnote 42: Feet of F. Herts. Trin. 39 Eliz.

Footnote 43: Recov. R. East. 2 Chas. I, rot. 17; Chan. Inq. p.m. (Ser. 2), ccccxxxv, 125.

Footnote 44: Chauncy, op. cit. 141. His arms impaling those of Martha Boothby his wife are on the stairs at Brent Pelham Hall, as is mentioned above.

Footnote 45: V.C.H. Herts. Families, 283.

Footnote 45a: Chauncy, op. cit. 142.

Footnote 46: Ibid.; Recov. R. Hil. 8 Anne, rot. 10.

Footnote 47: Add. MS. 5806, fol. 18.

Footnote 48: Feet of F. Herts. East. 19 Geo. II; Recov. R. East. 19 Geo. II, rot. 142.

Footnote 49: Cussans, *Hist. of Herts. Edwinstree Hund.* 137.

Footnote 50: Feet of F. Herts. Hil. 7 Geo. III.

Footnote 51: Clutterbuck, *Hist. of Herts.* iii, 450.

Footnote 52: Feet of F. Herts. Trin. 27 Geo. III; Mich. 1 Will. IV.

Footnote 53: Cussans, *Hist. of Herts. Edwinstree Hund.* 136.

Footnote 54: Newcourt, *Reperit.* i, 854.

Footnote 55: *Red Bk. of Exch.* (Rolls Ser.), 541. See above.

Footnote 56: See below.

A HISTORY OF HERTFORDSHIRE

them who occurs is Walter le Chamberleyn, who received small grants of land in the parish from Peter Fitz William le Grey,⁶⁷ John Prior of Berden in Essex, and Agnes de Wancy, widow.⁶⁸ In 1240 a contract was made for the marriage of his eldest son Henry to Agatha niece of Alexander, Treasurer of St. Paul's Cathedral,⁶⁹ and in 1278 a presentment was made to the justices in assize as to the encroachment committed by him in arching the king's highway.⁶⁰ His son may be identified in Henry le Chamberleyn, who made a grant of land in Brent Pelham to be held of himself for a yearly rent⁶¹ and who in 1303 was the tenant of the bishop in the fourth part of a knight's fee in the parish.⁶² He probably had for his heir John Chamberleyn of Brent Pelham, who in 1345 bequeathed to Sir Alan, vicar of the parish, a red cow to go before his own corpse on the day of his burial. His will makes mention of his late wife Alice, his wife Joan and his son Robert.⁶³

was made by Sir John de la Lee of Albury; for in 1361 Thomas le Grey went to Albury and asked counsel of Sir John, promising to be guided by him only. Subsequently he re-entered the manor, at this date called Chamberleyns, and furnished it with goods and chattels to the value of £10. In 1364, however, Sir John with his brother Robert and others of his servants expelled him. Sir John's successor, Sir Walter de la Lee, settled the manor of Chamberleyns in 1376,⁶⁵ but in 1406 his sister and co-heir Joan with her husband John Barley and Robert Newport and his wife Margery, another sister, released the manor to John Grey and Joan his wife,⁶⁶ on whom it had already been entailed in 1405 together with Greys Manor⁶⁷ (q.v.), the descent of which it afterwards followed.⁶⁸

BEECHES (Beches, Beaches, Batches), a manor in Brent Pelham held by Simon de Furneus in the reign of Edward I, had probably been part of the 2 hides and 1 virgate of land in Pelham of which Ralph de Furneus was tenant in 1210-11.⁶⁹ In 1278 Simon had free warren in Brent Pelham.⁷⁰ In 1287-8 he distrained Gilbert Sanke for his homage and service and the rent of 40s. 6d. which he owed, together with fealty and suit of court every three weeks at Simon's court of Brent Pelham.⁷¹ In 1306 an inquisition was taken to discover whether Simon might grant to the priory of Thremhall in Essex certain two messuages, 167½ acres of arable land, 4 of meadow, 16 of pasture and 2 of wood, together with rents worth 21s. 5½d. a



THE BEECHES, BRENT PELHAM: SOUTH-WEST FRONT

In 1355 this manor of Brent Pelham had passed to Sir Thomas Chamberleyn, kt., and Alice his wife, who then settled it on themselves, Stephen son of Thomas and the heirs of his body.⁶⁴ At his death soon afterwards Thomas was succeeded by Thomas le Grey as kinsman and heir of Stephen Chamberleyn. It appears, however, that a claim to the inheritance

year, in Brent Pelham and Furneux Pelham, held partly of Nicholas le Grey and partly of the bishop. In return the prior and convent would maintain chantries for the souls of Simon and his ancestors within their house and in Furneux Pelham Church.⁷² In the same year the bishop intimated to the king that he had consented to the proposed grant,⁷³ and it

⁵⁷ Add. MS. 5806, fol. 23 d.

⁵⁸ Ibid. 15 d.

⁵⁹ Ibid. 23 d.

⁶⁰ Herts. and Hants Assize R. Edw. I (Agarde's Index), fol. 88.

⁶¹ Add. MS. 5806, fol. 15 d.

⁶² *Feud. Aids*, ii, 431.

⁶³ *Hist. MSS. Com. Rep.* ix, App. i, 39. His funeral expenses amounted to 63s. 7½d., of which sum only 3½d. was spent on his coffin.

⁶⁴ Feet of F. Herts. 29 Edw. III, no. 441; see Add. MS. 5806, fol. 14 d.

⁶⁵ Close, 50 Edw. III, pt. ii, m. 9, 12, 13.

⁶⁶ Feet of F. Herts. 8 Hen. IV, no. 43.

⁶⁷ Ibid. 7 Hen. IV, no. 34.

⁶⁸ *Feud. Aids*, ii, 446; Chan. Inq. p.m. 5 Edw. IV, no. 27; (Ser. 2), cccxxxv, 125; Feet of F. Herts. Trin. 2 & 3 Phil. and Mary; East. 5 Eliz.; Trin. 29 Eliz.; Trin. 39 Eliz.; East. 19 Geo. II; Recov. R. Trin. 2 & 3 Phil. and Mary, rot. 432; Hil. 5 Eliz. rot. 503; East. 25 Eliz. rot. 87; Trin. 25 Eliz. rot.

157; East. 2 Chas. I, rot. 17; Hil. 8 Anne, rot. 10; East. 19 Geo. II, rot. 142; Chan. Proc. (Ser. 2), bde. 192, no. 49.

⁶⁹ See account of Furneux Pelham.

⁷⁰ Assize R. 323.

⁷¹ Chauncy, op. cit. 140. A marginal reference to the Exch. R. for Trin. 16 Edw. I cannot be identified.

⁷² Chan. Inq. p.m. 34 Edw. I, no. 224. See account of Furneux Pelham Church.

⁷³ London Epia. Reg. Baldock and Gravesend, fol. 4; *Hist. MSS. Com. Rep.* ix, App. i, 39a.

EDWINSTREE HUNDRED

BRENT PELHAM

was authorized by Letters Patent.⁷⁴ In 1536 the manor of Beeches in Pelham, which had lately belonged to Thremhall Priory, was granted in tail-male to John Cary and to Joyce Walsingham, to whom he was betrothed.⁷⁵ In 1566 it was regranted in tail to Wymond Cary⁷⁶ of Hackney, son and heir of John and of Martha daughter of Edmond Denny,⁷⁷ and Wymond in 1587 conveyed it to Philip Allington.⁷⁸ Chauncy states that Philip built a 'fair house' on the manor,⁷⁹ which at his death in 1595 passed to his son Christopher, who was only six years old.⁸⁰ A conveyance in 1616 between Thomas Draver and others and Thomas Byshopp, kt., and his wife Jane⁸¹ was probably for the purposes of a settlement.

According to Chauncy, Beeches was bought about the year 1640 by Adam Washington of Lincoln's Inn, who married Elizabeth eldest daughter of Francis Floyer of Brent Pelham Manor, and who devised it by will to his executors to be sold for the benefit of his children.⁸² It was thus acquired in 1672 by Felix Calvert,⁸³ who afterwards held Furneux Pelham Hall,⁸⁴ and was conveyed by him to his daughter's husband, William Wright, who was holder in 1700.⁸⁵ He in 1743 had been succeeded by his son Captain William Wright, an eccentric who had been crippled by a fall from his horse and who occupied the remains of Beeches Manor House, 'together with his horses, hogs and viler animals.' He had made it a rule that no repairs should ever be undertaken and he shifted from one room to another as each reached an inconvenient stage of decay. The outhouses were all demolished and, for lack of stables, the horses were lodged in the dairy, which had neither doors nor windows. 'The first time I ever saw him,' William Cole wrote of Captain Wright, 'was by his fireside upstairs in a sort of a dog kennel, for I can compare the room where he was to nothing better, being littered with everything conceivable in it. He sat without shoes, stockings or breeches, in a nasty greasy greatcoat, and nightcap and hat one would not have picked off a dunghill, and a shirt not changed I suppose since it was first bought. There was no other room glazed in the house but this and the next where his brother Felix and son lay, and the hogs and horses walked about as freely as the maidservants which were in plenty, no less than four strapping wenches who had nothing to do but obey their master and play at cards with him.' Captain Wright died unmarried in 1745, but his brother Felix, who succeeded him, did not comply with his request that he should be carried to the churchyard in his carrion cart. Cole, writing in this year, said that the new lord of the manor was 'a degree better than the deceased' and was 'going to fit the house up.'⁸⁶ He left the estate to his nephew George Wright, who died without issue in 1768 and whose widow Mary married Stephen Martin Leake.⁸⁷ His successor William Wright married Margaret Calvert, daughter of Felix Calvert of Furneux Pelham Hall. William Wright had two daughters, Susanna, who married Calvert Bowyer, and Honor, who married

Charles Parnell of Much Hadham.^{87a} In 1772 the manor was conveyed by fine by Calvert Bowyer and Hugh Parnell, son of Honor and Charles, and his wife Mary, and by Stephen Martin Leake and Mary his wife, who probably had an interest in it for the latter's life, to Francis Buxton.⁸⁸ In 1774 Hugh devised his moiety to his son Hugh, of whom it was bought by Calvert Bowyer. The latter in 1796 sold all the manor to John Woodley, by whose trustees it was sold to Samuel Smith of Woodhall Park, Watton.⁸⁹ After the death of Mr. Samuel George Smith of Sacombe Park in 1900 the property was sold to Mr. E. E. Barclay of Brent Pelham Hall.⁹⁰

The church of *ST. MARY THE CHURCH VIRGIN* consists of chancel 26 ft. by 18 ft. 6 in., nave 51 ft. 6 in. by 28 ft., west tower 12 ft. by 10 ft. 6 in., and modern south porch and north organ chamber; all the dimensions are internal. The walls are of flint rubble with stone dressings, the roofs are tiled.

The nave and chancel were built about the middle of the 14th century and the west tower about the middle of the following century. In the 19th century an organ chamber was added on the north side of the chancel, a south porch built and the whole church restored.

The chancel has a modern east window of three lights with traceried head. In the north wall is a modern arch to the organ chamber, in the north wall of which has been reset a mid-14th-century window of two lights with flowing tracery. In the south wall is a similar window and beside it is a plain doorway with pointed arch, much restored. In the north wall near the east end is a small niche with pointed arch, all of modern stonework. The chancel arch is of two moulded orders with label on the west side. The jambs are moulded and have three engaged circular shafts; the capitals and bases are moulded, the latter having moulded sub-bases.

There are three windows in the north wall of the nave and three in the south wall. The central window in each wall is of three lights, the others are of two lights. They have all traceried heads of 14th-century character, of modern stonework; the inner jambs are original. The north and south doorways are of two continuous wave-moulded orders, with moulded labels with returned ends; they are of mid-14th-century date. The north doorway is blocked, the south door is coeval with the doorway. The arched head is filled with flowing tracery, much worn; the door has been rebacked. On the faces of the two central buttresses on the north side of the nave are three crosses cut in the stonework; they each bear the form of a cross paty and are cut to a depth of about 1½ in.; they are from 7 in. to 9 in. across. One buttress has two crosses, one about 6 ft. from the ground, the other about 7 ft. higher; the other buttress has only one cross, about 4 ft. 6 in. from the ground. They may be consecration crosses.

The west tower is of three stages, with embattled parapet and slender lead-covered spire. The western

⁷⁴ *Cal. Pat.* 1301-7, p. 459.

⁷⁵ *L. and P. Hen. VIII*, xi, 202 (44).

⁷⁶ *Pat.* 8 Eliz. pt. i.

⁷⁷ *Visit. of Herts.* (Harl. Soc.), 135.

⁷⁸ *Pat.* 29 Eliz. pt. xiii; Feet of F. Herts. Mich. 29 & 30 Eliz.

⁷⁹ Chauncy, op. cit. 142.

⁸⁰ *Chan. Inq.* p.m. (Ser. 2), ccxliii, 71.

⁸¹ Feet of F. Herts. Trin. 14 Jas. I.

⁸² Chauncy, op. cit. 142.

⁸³ Feet of F. Herts. Trin. 22 Chas. II; Hil. 23 & 24 Chas. II.

⁸⁴ See account of Furneux Pelham.

⁸⁵ Chauncy, op. cit. 142; Salmon, *Hist. of Herts.* 289.

⁸⁶ Add. MS. 5806, fol. 18, 19, 27.

⁸⁷ Clutterbuck, *Hist. and Antiq. of Herts.* iii, 447.

^{87a} Deeds in possession of Mr. F. A. Crallan.

⁸⁸ Feet of F. Herts. Mich. 13 Geo. III.

⁸⁹ Clutterbuck, *Hist. and Antiq. of Herts.* iii, 447.

⁹⁰ Information from Mr. E. E. Barclay.

A HISTORY OF HERTFORDSHIRE

buttresses are diagonal and under one of them is a large block of flint conglomerate or 'pudding-stone.' In the north-west angle of the tower is a newel stair entered by a four-centred arched doorway from the inside. The tower arch is of two moulded orders, the outer order continuous, the inner resting on round engaged shafts with moulded capitals and bases; it is of 15th-century date. The west doorway is of two moulded orders with square head and blank shields in the spandrels. Over the doorway is an embattled string-course. The doorway is very similar to the west doorway at Layston. The west window is of three cinquefoiled lights with traceried head. The

cross issuing from the mouth of a dragon; at the centre of the cross is a winged figure bearing a soul in the form of a small figure, around which are the symbols of the Evangelists, all winged. Nothing is known about the tomb, which is ascribed to Piers Shonks, but a legend recounts that by the help of the miraculous flight of an arrow Piers found a place for his tomb which should cheat the devil, who, offended by the slaying of a dragon, had vowed to have his soul whether he were buried inside the church or out.

There are four bells. the first and second by Miles Graye, 1634; the third by J. Briant, 1792; the fourth by Miles Graye, 1637.

The communion plate includes a cup of 1628.

The registers before 1813 are as follows: (i) baptisms 1539 to 1690, burials 1539 to 1689, marriages 1551 to 1689; (ii) baptisms and burials 1690 to 1773, marriages 1690 to 1754; (iii) mixed entries 1539 to 1773; (iv) baptisms and burials 1773 to 1812, marriages 1754 to 1813.

The church of
ADVOWSON Brent Pelham is said to have been granted to the Treasurer of St. Paul's with that of Furneux Pelham by Bishop Richard de Beames of London between 1152 and 1162.⁹¹ In 1181 it was stated to have been appropriated to the treasurer's office, to pay 13*d.* annually to the archdeacon and 12*d.* as Peter's Pence and to have appurtenant to it 40 acres of land held in demesne and rents to the value of 8*s.* 4*d.*⁹² It was visited among other churches of the cathedral in 1252. The churchyard was then found to be very ill-inclosed. The steps before the altar were of mud, without stone, wood or cement. On the walls of the chancel there were no designs in plaster, and two panes of glass were missing in the place where the psalms were sung. The church had only five books, of which all but one were stated to be in bad condition. The treasure consisted of a silver chalice partly gilded, a chrismatory of tin and two old tin candlesticks, a small tin pyx insecurely hung in a bag above the altar, three old phials of tin, a small censer, two little bells for use at

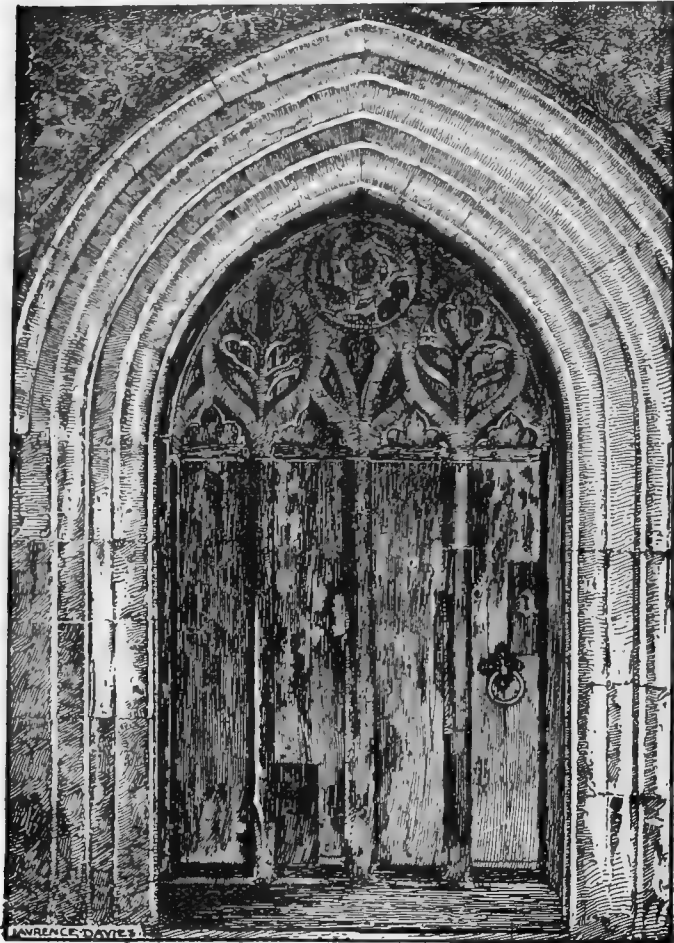

BRENT PELHAM CHURCH: THE SOUTH DOOR

belfry windows are of two cinquefoiled lights with traceried heads, partly of modern stonework. The whole tower was thoroughly restored and bells rehung a few years ago by Mr. Edward Barclay.

Under the tower arch is a modern oak screen, in which are incorporated some traceried heads from a screen of 15th-century date.

On the floor at the west end of the nave is a brass with two female figures and inscription to Mary, 1625, and Anne, 1627, wives of Francis Rowley. In an arched recess in the north wall of the nave is a tomb, on the top of which is a black marble slab, 5 ft. 6 in. long, decorated with carvings in high relief of 13th-century date. It represents a richly floreated

funerals, a little banner, red and yellow, and several vestments and cloths. There was a single crucifix over the high altar. Geoffrey Sarvors or Sarnors had granted 2 acres of land to be held by the Treasurer of St. Paul's in demesne for the finding of two candles on the high altar, but his foundation had not always been effectual. A collection of one-fourth from each message was customarily made for the Easter candle, and the lights otherwise depended on votive offerings. The ministers were a chaplain and his clerk, of whom the chaplain had his lodging near the graveyard and within the church's land. The church was said to be of the Blessed Virgin, but had

⁹¹ Newcourt, *Reper.* i, 853.

⁹² *Ibid.* 852.

not been dedicated.⁹³ In 1291 it was returned as of the annual value of £5.⁹⁴ It was with Furneux Pelham among the seven benefices held in 1294 by Robert de Drayton.⁹⁵ It was again visited by officers of St. Paul's in 1297. They found the graveyard ill-inclosed, unclean and not consecrated, with all its entrances open; an unthatched belfry in a bad state of repair, in which were two ill-tuned bells; a church still unconsecrated and ill-thatched with straw, having weak doors without good locks or bars. The windows were also in need of bars and some of them in the chancel lacked glass. The church had four unconsecrated altars. A painted crucifix in the middle of the nave, which had on either side images of the Virgin and of St. John, had been injured by rain, and here were also images of St. Nicholas and St. Katherine. The seats, lecterns and forms were sufficient. The church had eight books, including an ordinal of St. Paul's use. The treasure and vestments had increased since 1252.⁹⁶

In 1314 this church, like that of Furneux Pelham, was exempted from the sphere of the king's purveyors.⁹⁷ In 1458 it was visited by the Dean of St. Paul's and one of the canons. They found that

dissolution of religious houses the vicarage was of the annual value of £7.⁹⁸ An inventory of the goods of the church made in 1552 mentions only one silver chalice partly gilded, a copper cross, four vestments of red, blue, white and green satin, three corporales and two handbells, as well as three bells which were in the steeple.¹⁰⁰ At the date of the dissolution of guilds and chantries a rent of 6*d.* was received from each of 2 acres of land for the maintenance of a light.¹ The advowson continued to be held by the Treasurer of St. Paul's.² In July 1771 the vicarage was consolidated with that of Furneux Pelham.³ The two parishes became in 1845 part of the diocese of Rochester and the patronage was given as from the time of the death of the existing Treasurer of St. Paul's to the Bishop of Rochester. The treasurer presented for the last time in 1864.⁴ The rectory of Brent Pelham was vested in 1858 in the Ecclesiastical Commissioners,⁵ who in 1859 were authorized to sell it.⁶ In 1877, when the two parishes were included in the diocese of St. Albans,⁷ the Bishop of St. Albans became patron.

The charity of Francis Floyer, *CHARITIES* founded by will 1678, formerly under the management of the Mercers'

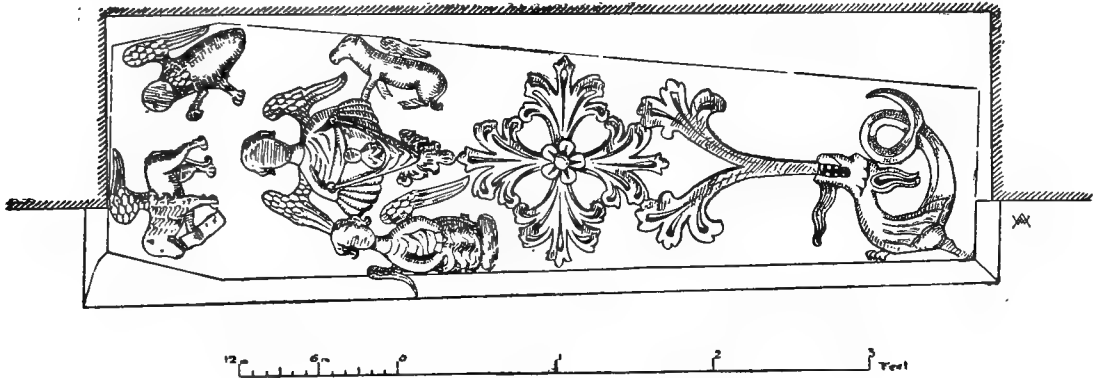

BRENT PELHAM CHURCH: SHONKS'S TOMB

the roof had been removed in order that it might be renewed. The roofing of the chancel with shingles was defective and so were its corner stones and the stonework of a northern window. Complaint was made that the vicar kept his horse in the graveyard, that he frequently preached discreditably, that he did not publish sentences of excommunication and that during the solemnities of canonical hours he chatted with his parishioners, both men and women. Only six books of the church are mentioned, but the store of vestments was considerable and apparently valuable. The treasure had otherwise been increased by two silver chalices and several articles of copper-gilt and brass, and by two alabaster tablets showing the Trinity and the five joys of Mary, and a third tablet, not said to be of alabaster, having on it the figure of St. Anthony.⁹⁸ At the time of the

Company, London, is endowed with £184 1*s.* 3*d.* consols and £312 2½ per cent. annuities, arising from the redemption in 1893 by the said company of a yearly payment of £7 16*s.*

The charity of Mrs. Catherine Floyer, founded by will 1758, is endowed with £226 18*s.* 2*d.* consols.

The several sums of stock are held by the official trustees, and the annual dividends, amounting together to £18 1*s.* 8*d.*, are applied under the provisions of a scheme of the Charity Commissioners of 18 April 1884, in the distribution of bread and coal.

The official trustees also hold a sum of £54 5*s.* 11*d.* consols, arising in 1860 from a legacy of £25 by a codicil to the will of the late Mr. G. W. Hallam and an addition of £25 by the testator's widow.

The dividends, amounting to £1 7*s.* yearly, are applicable for the repair of the National school.

⁹³ *Camden Misc.* (Camden Soc.), ix, 20.

⁹⁴ *Pope Nich. Tax.* (Rec. Com.), 15, 18.

⁹⁵ *Cal. Pat.* 1292-1301, p. 118.

⁹⁶ *Visit. of Churches of St. Paul's* (Camden Soc.), 42-5.

⁹⁷ *Cal. Pat.* 1313-17, p. 190.

⁹⁸ *Visit. of Churches of St. Paul's* (Camden Soc.), 103-5.

⁹⁹ *Valor Eccl.* (Rec. Com.), i, 452.

¹⁰⁰ *Visit. of Churches of St. Paul's* (Camden Soc.), 120.

¹ Chant. Cert. 27, no. 35.

² Inst. Bks. (P.R.O.).

³ Clutterbuck, op. cit. iii, 449.

⁴ *Lond. Gaz.* 20 Aug. 1845, p. 2541; Cussans, *Hist. of Herts. Edwinstree Hund.* 143.

⁵ *Lond. Gaz.* 11 June 1858, p. 2879.

⁶ *Ibid.* 27 Sept. 1859, p. 3524.

⁷ *Ibid.* 4 May 1877, p. 2933.

A HISTORY OF HERTFORDSHIRE

FURNEUX PELHAM

Pelham or Pellam, Furnell, Furneus, Furnaus, Forneus, Fournaus (xiii and xiv cent.).

The parish of Furneux Pelham has an area of 2,585 acres, of which 7 are water. Rather less than half the parish is arable and about one-fifth permanent grass.¹ The altitude varies from 300 ft. to 400 ft., the highest ground being at the northern end of the parish. The soil is mixed, the subsoil clay and chalk.

The village surrounds the church and has at one end Furneux Pelham Hall, the manor-house. This was probably built by Edward twelfth Lord Morley late in the 16th century, and is almost entirely of brick, the only part timber-framed and plastered being the north gable of the west wing; the roofs are tiled. The building is L-shaped on plan, the main block facing south and having a wing at its western end projecting northwards. During the

story, the marks of which still remain on the front, they were altered in the 17th century, and have all square moulded labels and modern casements. The windows on the east and west fronts have no labels; they retain their 17th-century flush window frames. On the east front are two plain projecting chimney stacks; the tops have been rebuilt, but the bases of octagonal shafts are left. Between the chimney stacks was a gable with a large circular opening or panel in the centre, but the upper part is gone; the chimneys and gable were part of the 17th-century alterations. The east side of the west wing has two small crow-stepped gables and between them is a semicircular gable of 17th-century date. The plan of the house appears to have undergone considerable alterations late in the 17th century. The entrance hall or corridor, which is 12 ft. wide and has an old wall on each side, was carried through to the back, where it

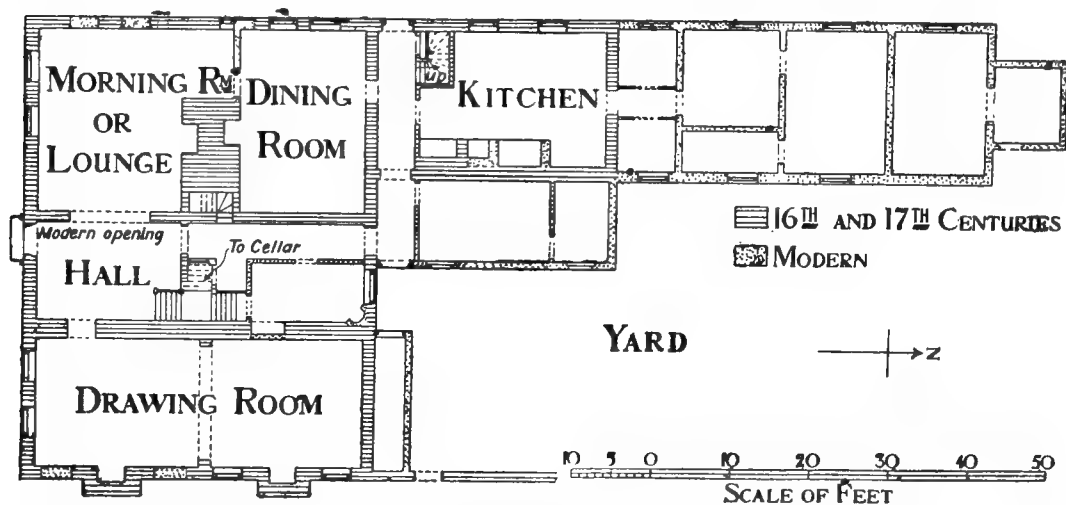

PLAN OF FURNEUX PELHAM HALL

latter part of the 17th century, probably after it was purchased by Felix Calvert in 1677, it underwent considerable alterations and was partly refaced; in the 19th century additions were made north and east of the west wing. The house is of two stories with attics, and beneath the drawing room at the south-east angle is a small cellar. The south and west fronts have each three curvilinear gables added in the 17th century; the original gables were crow-stepped, traces of which can be seen. The gables on the north side of the main block and on the east side of the wing still retain their steppings. The attic windows in the gables are original; one of those on the north side has three round-arched lights. They have all square moulded labels over; those on the east front retain their original oak moulded frames and mullions, the others being modern. The main entrance is in the middle of the south front; it is of late 17th-century date with wooden pilasters and flat hood above. The windows of the ground and first story of the south front are arranged in pairs, except in the central gable, which has only one, but originally there was only one wide mullioned window to each

communicates with the west wing; the principal stair occupies the central portion. To the east is the drawing room; it was originally two rooms, but the division wall has been removed and the door from the north room to the corridor blocked. The stair is of late 17th-century date. Its plan is peculiar. It is placed between the two doors of the rooms converted into the drawing room; the first six steps lead to a square landing, where the stair turns to the left, but across the landing are six steps down to the former level at the blocked doorway to the drawing room. The reason for this is not clear, as there is sufficient headroom to pass under the upper landing. The stair has plain moulded balusters. To the west of the corridor is a lounge (until recently the dining room) with a wide modern opening into it. Behind the lounge and separated from it by the substructure of an original chimney stack is the dining room (formerly the kitchen); at the east end of the brickwork of the chimney is a small private stair, now disused, opening into the corridor. The kitchen in the west wing has a portion of the original four-centred arch over the fireplace. In an ante-room on the first floor is a stone fireplace with moulded

¹ Statistics from Bd. of Agric. (1905).

EDWINSTREE HUNDRED FURNEUX PELHAM

four-centred arch and moulded cornice above; it is of late 17th-century date. There is another of plainer character in the dining room, but it has been brought from elsewhere. The drawing room is panelled with large bolection-moulded oak panels of late 17th-century date. In the dining room and in some of the first-floor rooms is early 17th-century panelling, also some pilasters, friezes and mantelpieces with arabesque carving. A dressing room over the entrance hall has an original heavy oak moulded door frame with a square head. In the cellar under the south end of the drawing room is a blocked fireplace of stone with plain four-centred arch; in the walls are several small brick recesses with splayed round-arched heads.

The Yew Tree Inn, east of the vicarage, is a late 16th-century building of two stories; it is timber-framed and weather-boarded, with tiled roof, but has been modernized. A room on the ground floor, now divided into taproom and passage, has a wide fireplace with ingle seats; the lintel is of wood. The ceiling has some well-moulded beams and all the joists are hollow-chamfered on their lower edges and have carefully worked stops. The chimney stacks are of thin bricks but quite plain. There are several late 16th or early 17th-century cottages in the village, nearly all timber-framed and plastered; some of the plaster work is panelled and filled with combed work. Many of the cottages are thatched.

At East End there is a mission church connected with the parish church, and in the village itself there are Congregational and Primitive Methodist chapels. There is a brewery at Barleycroft End. There are outlying houses at Barleycroft End, where the road through the village meets Violets Lane,² at its junction with the road to Stocking Pelham,³ and, further east, at East End. St. John's Pelham, where there is a large moat, and Whitebarns, both the property of Mr. E. E. Barclay of Brent Pelham, stand on high ground in the northern part of the parish, the former west of the latter. Hixham Hall, now a farm, is in the south-eastern corner of Furneux Pelham, near the boundaries of Albury and Essex. Of early place-names Sininecroft occurs in the 13th century.⁴ The meadows called Songeres and Upheas were held between 1558 and 1579 by the Master and fellows of Queens' College, Cambridge.⁵ Field-names in Whitebarns in 1651 are Mowgrave, Bridgefeild, Springe Croft, White Barne Feild and Lammameadow in Sillymeade.⁶ In 1813 Hitchfield, Pristol, Bushey Leys and Burnt Ground were among the fields of Hixham Hall.⁷

FURNEUX PELHAM cannot be **MANORS** certainly distinguished in the Domesday Survey from the other Pelhams, all

of which were held of the Bishop of London in 1086⁸ and afterwards.⁹ Since, however, it was in the 14th century in the same tenure as Hixham Hall, it may be conjectured that in 1086 it was comprised by the holding of Ranulf, then a tenant of the bishop in Hixham (q.v.) and in Pelham.¹⁰

In 1175-6 there is mention of Ralph de Furnell in the Pipe Roll for Hertfordshire.¹¹ Again Ralph de Furneus or Furnell occurs in 1197 as a tenant in the county¹² and is mentioned in 1199-1200.¹³ In 1210-11 he or another tenant of this name held of the Bishop of London 2 hides and 1 virgate of land for the service due from a knight's fee and three parts of one.¹⁴ It is likely that he was succeeded by Simon son of Ralph de Furneus, receiver of scutage in Hertford in 1235¹⁵ and holder of a vill of Pelham, of whose court in Furneux Pelham there is mention between 1229 and 1241.¹⁶ This tenant was probably followed by Simon de Furneus, who held the park of Furneux Pelham in 1274-5¹⁷ and who claimed in right of a grant by Henry III to have free warren in the manor.¹⁸ In 1303 he was said, with his tenants, to hold of the bishop half a knight's fee in the parish.¹⁹ In 1309 he granted his manor of Furneux Pelham to William le Gros.²⁰ The latter's heir was probably Hugh le Gros, whose widow Alice died in 1366 as tenant of the manor, which had been settled on her and her husband and the heirs of their bodies. It was then said to be held of the bishop, with Hixham Hall (q.v.), by the service due from one knight's fee and a rent of 7s. 6d. It passed to William le Gros, son of Hugh and Alice,²¹ who died in 1368, while yet a minor, and left a son and heir William, who was only a year old.²² The latter was succeeded by his uncle John, who was knighted,²³ and who was dead in 1384.²⁴ In 1387-8 Sir Richard de Sutton, kt., and Ralph Aynell, parson, who were probably John's executors, conveyed the manor to Thomas Bideford in exchange for that of East Tilbury in Essex,²⁵ and in 1406 John son and heir of Thomas Bideford released all his right to Robert Newport and his wife Margery and their heirs.²⁶ Robert was returned to Parliament as a member for Hertfordshire in 1400-1 and 1411.²⁷ He died between 1414²⁸ and 1428. At the latter date the tenant of Furneux Pelham was Margery, then widow of John Duram.²⁹ In 1431 she and Henry Hert, apparently her third husband, conveyed the manor to William



FURNEUX. *Argent a bend between six martlets gules.*

² To be identified possibly with Phyllot Lane mentioned in 1651 (Close, 1651, pt. xxiv, m. 27).

³ In 1651 a lane called Cut Throat Lane from the vicinity of Whitebarns to Bishop's Stortford is mentioned (ibid.).

⁴ Doc. of D. and C. of St. Paul's, Liber A. Pilosus, fol. 18b.

⁵ Chan. Proc. (Ser. 2), bdle. 202, no. 37.

⁶ Close, 1651, pt. xxiv, m. 27.

⁷ Com. Pleas D. Enr. East. 53 Geo. III, m. 28. ⁸ *V.C.H. Herts.* i, 307a, 307b.

⁹ For the bishop's overlordship of Furneux Pelham see *Feud. Aids*, ii, 431, 446; Chan. Inq. p.m. 40 Edw. III, no. 16;

42 Edw. III, no. 25; 12 Hen. VI, no. 36; (Ser. 2), xxiii, 61; xxxiv, 96.

¹⁰ See Brent Pelham.

¹¹ *Pipe R. 22 Hen. II* (Pipe R. Soc.), 6.

¹² *R. of the King's Ct. Ric. I* (Pipe R. Soc. 24), 212.

¹³ Palgrave, *Rot. Cur. Reg.* (Rec. Com.), ii, 275.

¹⁴ *Red Bk. of Exch.* (Rolls Ser.), 541.

¹⁵ *Testa de Nevill* (Rec. Com.), 265b.

¹⁶ Doc. of D. and C. of St. Paul's, Liber A. Pilosus, fol. 18b.

¹⁷ *Hund. R.* (Rec. Com.), i, 193.

¹⁸ *Assize R.* 323, 325.

¹⁹ *Feud. Aids*, ii, 431.

²⁰ Feet of F. Herts. Hil. 2 Edw. II, no. 22.

²¹ Chan. Inq. p.m. 40 Edw. III, no. 16; *Cal. Close*, 1364-8, p. 318.

²² *Cal. Close*, 1364-8, p. 451; Chan. Inq. p.m. 42 Edw. III, no. 25. The elder William is called John in the writ for the inquisition, but nowhere else.

²³ Close, 10 Ric. II, m. 27-9d.

²⁴ Chan. Inq. p.m. 7 Ric. II, no. 156.

²⁵ Close, 11 Ric. II, m. 18, 20d.

²⁶ *Ibid.* 8 Hen. IV, m. 36; Feet of F. Herts. 8 Hen. IV, no. 49.

²⁷ *V.C.H. Herts. Families*, 290.

²⁸ Feet of F. Herts. 2 Hen. V, no. 9.

²⁹ *Feud. Aids*, ii, 446.

A HISTORY OF HERTFORDSHIRE

Newport,³⁰ who was presumably son of Robert, and who represented Hertfordshire in Parliament in 1427 and 1433³¹ and died in 1434. The manor was then surveyed as consisting of a messuage and other houses, 400 acres of arable land, 100 acres of meadow and 10 acres of wood, a garden, rents of assize of the annual value of 40*s.* and a view of frankpledge and a court worth 12*d.* a year in addition to the steward's fees and expenses. The heir of William was his son George,³² who died in 1484 and left a son and heir Robert,³³ Sheriff of Hertfordshire in 1496,³⁴ who in 1518 was succeeded by his son John.³⁵ The latter at his death in 1523 left a daughter and heir Grace, who a week previously, when only eight years old, had married Henry the son and heir of Lord Morley.³⁶

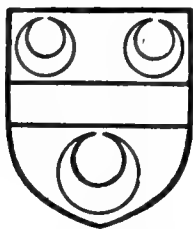

NEWPORT. *Argent a fesse between three crescents sable.*

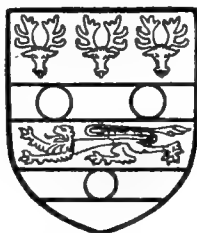

PARKER, Lord Morley. *Argent a lion passant guardant gules between two bars sable with three bezants on the bars and three harts' heads caboshed sable in the chief.*

In 1538 the manor was settled on her and her husband, then Sir Henry Parker, kt., with successive remainders in tail-male to their sons Henry, Thomas and Charles, to their own heirs male and to the heirs of Grace.³⁷

Sir Henry Parker, who was Sheriff of Hertfordshire in 1536,³⁸ died in 1551 in his father's lifetime. His son and heir Henry became eleventh Lord Morley in 1555³⁹ and died in 1577, when in right of the settlement of 1538 Furneux Pelham passed to his son and heir Edward, twelfth baron.⁴⁰ The entail was barred by Lord Morley and his son William by settlements of 1583⁴¹ and 1600.⁴² Soon after the latter date the manor was alienated to Edward Newport, Sheriff of Hertfordshire in 1622,⁴³ on whose son and heir John and the latter's wife Mary Sulyard it was settled in 1614.⁴⁴ John succeeded to the manor at his father's death in 1624.⁴⁵ He was an ardent Royalist, and Salmon relates of him that he led out all his four sons to fight for the king.⁴⁶ He died in 1646 from the effects of a wound

received in a skirmish near Figheldean in Wiltshire⁴⁷ and his lands were forfeited. In 1650, however, his widow Mary received leave from the committee for compounding to enjoy his mansion-house at Pelham and one-third of his estates.⁴⁸ At the Restoration his eldest son John⁴⁹ entered on his inheritance. He died without issue and was succeeded by his brother William, who was lord of the manor in 1700.⁵⁰ He also died childless, and, in accordance with a settlement made by him, the manor passed to the son of his brother Thomas, John Francis Newport. The latter's son and heir John held in 1728.⁵¹ In 1760⁵² and 1766⁵³ the holder was William Newport. He in 1780 conveyed the manor to John Calvert,⁵⁴ at whose death in 1804 it passed to his son John,⁵⁵ who died in 1859 and by the trustees of whose will it was sold to Captain Brown. He soon afterwards conveyed it to George Shaw of Barneparks in Teignmouth, Devon, who was lord of the manor in 1870.⁵⁶ It is now the property of Mr. Amos Gilbert Pembroke of Ford Heath Chislet, near Canterbury.⁵⁷

Furneux Pelham Hall, the manor-house, was not conveyed with the manor at the beginning of the 17th century to Edward Newport, but was sold about the same time⁵⁸ by Lord Morley to Richard Mead.⁵⁹ According to Chauncy, Mead pulled down a great part of the house as being too large for his estate and, having sold the materials, made of the rest a convenient habitation for himself.⁶⁰ It passed at his death to his son Thomas, who in 1614 sold it to Edward Cason of the Middle Temple. In 1615 it was settled on Edward and his wife Susan daughter of Sir Robert Oxenbridge, with successive remainders to their second son Edward and others of their sons in tail-male. The elder Edward died in 1624.⁶¹ His widow married Sir Thomas Cecil, kt.,⁶² younger son of the Earl of Salisbury. 'She was a proper comely lady, endowed with a most rare and pregnant wit, a florid and ready tongue, very sharp, but witty in her repartees; her common discourse did much exceed the ordinary in her sex.' She lived to a great age.^{62a} Chauncy states that in 1641 she joined with Sir Thomas Cecil in conveying her life interest in Furneux Pelham manor-house to her son Edward, the reversionary heir. He in 1677 sold the house and the parks, lately paled and stocked with deer, to Felix Calvert,⁶³ son of Felix Calvert of Little Hadham.⁶⁴ Felix is said to have died in 1699, and he was succeeded by his eldest surviving son William, who died in 1749. From him Furneux Pelham Hall passed to his eldest son Felix, who owned a house and a share in a brewery in Thames Street and who at his death in 1755 was succeeded by his

³⁰ Feet of F. Herts. 9 Hen. VI, no. 47.

³¹ *V.C.H. Herts. Families*, 290.

³² Chan. Inq. p.m. 12 Hen. VI, no. 36.

³³ *Ibid.* (Ser. 2), xxiii, 61.

³⁴ *V.C.H. Herts. Families*, 282.

³⁵ Chan. Inq. p.m. (Ser. 2), xxxiv, 96.

³⁶ *Ibid.* xlii, 96.

³⁷ Feet of F. Herts. East. 30 Hen. VIII.

³⁸ *V.C.H. Herts. Families*, 283.

³⁹ *G.E.C. Peerage*, v, 372.

⁴⁰ W. and L. Inq. p.m. xix, 91.

⁴¹ Feet of F. Herts. East. 25 Eliz.; Recov. R. East. 25 Eliz. rot. 87.

⁴² Feet of F. Herts. Trin. 42 & 43 Eliz.; Recov. R. Trin. 42 Eliz. rot. 75.

⁴³ *Visit. of Herts.* (Harl. Soc.), 79; *V.C.H. Herts. Families*, 283.

⁴⁴ Feet of F. Herts. Mich. 12 Jas. I.

⁴⁵ Chan. Inq. p.m. (Ser. 2), ccccxxv, 125.

⁴⁶ Salmon, *Hist. of Herts.* 286.

⁴⁷ Cussans, *Hist. of Herts. Edwinstree Hund.* 86.

⁴⁸ *Cal. Com. for Comp.* 2663.

⁴⁹ *Ibid.* 2616.

⁵⁰ Chauncy, *Hist. Antiq. of Herts.* 144.

⁵¹ Salmon, *Hist. of Herts.* 286.

⁵² Recov. R. East. 33 Geo. II, rot. 41.

⁵³ Feet of F. Herts. Trin. 6 Geo. III.

⁵⁴ *Ibid.* Trin. 20 Geo. III. The conveyance at this date was apparently incomplete, for in 1782 William Newport

and his son William were vouches in a recovery of the manor (Recov. R. East. 22 Geo. III, rot. 188).

⁵⁵ Recov. R. East. 44 Geo. III, rot. 23.

⁵⁶ Cussans, *op. cit. Edwinstree Hund.* 150.

⁵⁷ Information communicated by Mr. W. Minet.

⁵⁸ Before 1618 when Edward Lord Morley died.

⁵⁹ Chan. Inq. p.m. (Ser. 2), dxxxii, 4.

⁶⁰ Chauncy, *op. cit.* 144.

⁶¹ Chan. Inq. p.m. (Ser. 2), dcccxlvi, 4.

⁶² *Visit. of Herts.* (Harl. Soc.), 37.

^{62a} Chauncy, *op. cit.* 145.

⁶³ *Ibid.*

⁶⁴ *V.C.H. Herts. Families*, 55.



FURNEUX PELHAM HALL FROM THE SOUTH-WEST



FURNEUX PELHAM CHURCH : 13TH-CENTURY PISCINA AND SEDILIA

EDWINSTREE HUNDRED

FURNEUX PELHAM

son Nicolson Calvert of Hunsdon, Sheriff of Hertfordshire in 1749 and member for Tewkesbury in 1754, 1761 and 1768. 'In his political career he was an ardent friend to public liberty . . . affable in his manner he naturally conciliated esteem; lively in his conversation and well acquainted with general history he could not fail to render himself an agreeable companion, . . . he has left behind him a character which is highly worthy of imitation and which must ever be respected.' He died childless in 1793 and had for heir his brother Felix of Portland Place and Thames Street, an eminent brewer, who shot himself in Don Salteno's coffee-house in Cheyne Walk, Chelsea, on the evening of 23 March 1802. His landed estate passed to his eldest son Nicolson, who was member for Hertford borough in 1802, 1806, 1807, 1812, 1818 and 1820, and for the county from 1826 to 1834. He married Frances youngest daughter of Edmond Sexten Lord Pery and died in 1841. His eldest son, Lieutenant-General Felix Calvert of Hunsdon, of the 72nd Regiment, served in the Peninsula and at Waterloo and died without issue in 1856. Edmond Sexten Pery, second surviving son of Nicolson Calvert, succeeded to Furneux Pelham and was a justice of the peace and a deputy-lieutenant for Hertfordshire. He died in 1866 and Furneux Pelham Hall passed to his eldest son, Felix Calvert, J.P.,⁶⁵ who died in 1910. It has been recently purchased by Mr. C. Woodall.

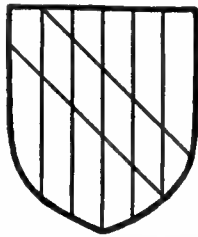

CALVERT. *Paly or and sable a bend counter-coloured.*

In 1086 a hide of land in Pelham, previously in the tenure of Alured, a man of Asgar the Staller, was held of the bishop by Payn.⁶⁶ It is possible that this holding constituted the alleged manor of *PAYNSTON*,⁶⁷ which was held with Furneux Pelham Manor in 1434⁶⁸ and which was probably identical with the messuage and land called Payston Ende which were held with it in 1557.⁶⁹ The latter presumably now bears the name of Patient End.

HIXHAM HALL (Tedricesham, xi cent.; Hiderisham, Thiderisham, xiv cent.; Tedresham, Thethirisham, xv cent.; Hedsham, Teddersham, Tetttersham, xvii and xviii cent.) was before the Conquest in the tenure of Wlwi, a man of Asgar the Staller, who had the right to sell. It was held of the bishop in 1086 by William and Ranulf, and was then assessed at a hide and a half and had arable land for three ploughs, woodland to feed 60 swine and pasture for the live stock.⁷⁰ The manor was discovered at the death in 1366 of Alice widow of Hugh le Gros to have been settled on her and her husband on the same terms as Furneux Pelham,⁷¹ with which manor it subsequently

passed.⁷² It was surveyed in 1434 as containing a messuage and other buildings, 100 acres of arable land, 6 acres of meadow and 10 acres of pasture.⁷³ In 1766 it was separated from Furneux Pelham Manor, being sold by William Newport and his wife Mary to Lee Steer,⁷⁴ who in 1785 and 1794 settled it on his grandson Lee Steer Witts, with remainder to the latter's son Lee Steer in tail-male, subject to an annual rent-charge for the benefit of the devisor's daughter Martha wife of Richard Witts and mother of the elder Lee Steer Witts. The latter, in compliance with his grandfather's will, assumed the surname of Steer in place of Witts. In 1813 he with his mother broke the entail of Hixham Manor and sold it, with the exception of 32 acres of wood called the Home Wood and one or two fields, to George Dyer. The property conveyed had an area of more than 168 acres and was almost entirely arable land.⁷⁵

Hixham Hall is now a farm held by the executors of the late Mr. Bowman.

ST. JOHNS PELHAM (Jonys of Pelham, xv cent.; Jonnespelham, xvi cent.). Walter Fitz William de Pelham, who died in 1292, held in Furneux Pelham of the Bishop of London 66½ acres of arable land, on which was a dovecote, and 3 acres of wood by military service and suit of court every three weeks and by rendering a yearly rent of 40*d.* and homage, scutage and reliefs. He also held of Simon de Furneus 88 acres of arable land, 4½ acres of wood, 4 of meadow and 6 of pasture, as well as rents of assize to the annual value of 25*s.* 5*d.* and customary works worth 12*s.* 5½*d.* in Furneux Pelham Manor, all by military service and suit of court every three weeks and by rendering 4½*d.* a year to Simon and homage, scutage and reliefs and 9*d.* yearly to the ward of Stortford Castle. His heir was his son William.⁷⁶⁻⁷ In 1303 his heirs were said to hold a fourth part of a knight's fee in Furneux Pelham of the Bishop of London.⁷⁸ It is possible that the lands of Walter Fitz William constituted the alleged manor of Johns Pelham, all right in which was released in 1408-9 by Robert Newport, who had lately acquired Furneux Pelham Manor, to Thomas son and heir of Walter Kilee, late citizen and fishmonger of London and holder of Johns and its appurtenant lands in this and neighbouring parishes.⁷⁹ In 1428 the fourth part of a fee once in the tenure of Walter Fitz William was held by William Rook.⁸⁰ Johns Pelham was afterwards held by Ralph Grey, tenant of Brent Pelham Manor, who died in 1492, and was inherited by his infant daughter Elizabeth.⁸¹ It probably passed afterwards with Brent Pelham and with that manor came to the owners of the manor of Furneux Pelham,⁸² for at some date before 1577 it was in the tenure of a lessee of Lord Morley⁸³ and the latter at his death was holder of the capital messuage called Johns-a

⁶⁵ *V.C.H. Herts. Families*, 55-61.

⁶⁶ *V.C.H. Herts.* i, 307a.

⁶⁷ Otherwise Paynottis.

⁶⁸ Chan. Inq. p.m. 12 Hen. VI, no. 36.

⁶⁹ Com. Pleas D. Enr. Mich. 4 & 5 Phil. and Mary.

⁷⁰ *V.C.H. Herts.* i, 307b.

⁷¹ Chan. Inq. p.m. 40 Edw. III, no. 16.

⁷² *Ibid.* 42 Edw. III, no. 25; Close,

11 Ric. II, m. 18, 20 d.; 8 Hen. IV,

m. 36; Feet of F. Herts. 8 Hen. IV, no. 49; 2 Hen. V, no. 9; 9 Hen. VI,

no. 47; Chan. Inq. p.m. (Ser. 2), xxiii,

61; xxxiv, 96; xlii, 96; cccxxxv, 125;

Feet of F. Herts. East. 30 Hen. VIII;

East. 17 Jas. I; Recov. R. East. 33

Geo. II, rot. 41.

⁷³ Chan. Inq. p.m. 12 Hen. VI,

no. 36.

⁷⁴ Feet of F. Herts. Trin. 6 Geo. III.

⁷⁵ Com. Pleas D. Enr. East. 53

Geo. III, m. 28.

⁷⁶⁻⁷ Chan. Inq. p.m. 21 Edw. I, no. 39; cf. *Cal. Fine R.* 1272-1307, p. 326, where

Walter is erroneously called a tenant in chief. ⁷⁸ *Feud. Aids*, ii, 431.

⁷⁹ Close, 10 Hen. IV, m. 10, 22, 25.

⁸⁰ *Feud. Aids*, ii, 446.

⁸¹ Chan. Inq. p.m. (Ser. 2), xii, 108.

⁸² See account of Brent Pelham.

⁸³ Chan. Proc. (Ser. 2), bdle. 138,

no. 59. A fine of the manor was levied

by Andrew Grey and Anne his wife in

1583 (Feet of F. Herts. East. 25 Eliz.).

By this Andrew may have relinquished an hereditary right to the manor.

A HISTORY OF HERTFORDSHIRE

Pelham. So long as the family of the lords of Morley were tenants of Furneux Pelham Manor, Johns was treated as held by them separately from that property and was called a manor.⁸⁴ The property now belongs to Mr. E. E. Barclay of Brent Pelham.

WHITEBARNES or *RECTORY MANOR* probably formed a part of the original endowment of the parish church and was the holding of the priest mentioned in the Domesday Survey.⁸⁵ The church of Furneux Pelham was, according to Dugdale and Le Neve, given to the canons of St. Paul's and annexed to the office of the cathedral treasurer by Richard de Beames,⁸⁶ Bishop of London from 1152 to 1162, and this grant must have included part of the lands which constituted the rectory manor. In 1181 there were appurtenant to the church, which belonged to the treasurer, 80 acres of land held in demesne, customary works for four days in the week and rents to the value of 4s. 3d.⁸⁷ The greater extent of the later rectory manor may have been due to the inclusion in it of lands which pertained in 1181 to Brent Pelham Church, also held by the treasurer,⁸⁸ or to a grant of land made in the early 13th century by Simon de Furneux to his mother church of Furneux Pelham and the rectors there.⁸⁹ The manor was surveyed in 1297. It then included a capital messuage and a garden, a dovecote, 7 acres of wood in le Haye, 1½ acres of pasture and 111 acres of arable land, and there were two tenants at the will of the lord.^{86a}

In 1314 the king's purveyors were forbidden to take anything from the churches of the canons of St. Paul's at Pelham and elsewhere which pertained to the brew-house of the cathedral and the sustenance of the canons and other ministers,⁹⁰ and such exemption probably included the rectory manor. The dean and chapter in 1322 received protection for two years in their manor of Furneux Pelham.⁹¹ In 1334 the king granted to his clerk, Thomas de Asteley, whom he had appointed Treasurer of St. Paul's, that the dwelling-house in Pelham appurtenant to his office should be quit of the livery of the stewards, chamberlains and marshals, or any royal or other minister, so that none such might there lodge or lodge others.⁹² In 1651 the trustees for the goods of cathedral churches sold the rectory manor of Furneux Pelham, otherwise called 'White Barnes,' to Richard Cutts of Arkesden in Essex and Anthony Knightsbridge of Gray's Inn. The lands of the manor were less than in 1297, for they comprehended only some 93 acres of arable, meadow and pasture land and a copse of 5 acres 2 roods.⁹³ At the Restoration the rectory manor returned to the Treasurer of St. Paul's, under whom it was held on lease in 1728.⁹⁴ The endowment of the trusteeship became vested in the Ecclesiastical Commissioners in 1858.⁹⁵ Whitebarns now belongs to Mr. E. E. Barclay of Brent Pelham.

The church of *ST. MARY THE CHURCH VIRGIN* consists of chancel 27 ft. by 19 ft., south chapel 26 ft. by 20 ft., nave 47 ft. by 19 ft., north aisle 11 ft. wide, south

aisle 11 ft. 6 in. wide, west tower 9 ft. 6 in. square, south porch 12 ft. 6 in. by 11 ft.; all the dimensions are internal. The walls are of flint rubble with oolite dressings, except to the porch, which has clunch dressings; the north aisle is cement covered.

The chancel is of late 13th-century date. The west tower was added about 1370-80. The north and south aisles with the arcades and clearstory belong to the early years of the 15th century. The south chapel is said to have been erected by Robert Newport, who died in 1518. The church was restored in the 19th century and most of the windows renewed.

The east window of the chancel is of three lights with modern tracery. The rear arch is moulded and has shafted jambs; it is of 13th-century date. In the north wall are three 13th-century lancet windows, the westernmost of which is a low-side window, blocked; it is about 12 in. wide, and the sill outside is 3 ft. 6 in. from the ground. The hooks for the casement hinges still remain. The easternmost lancets on each side of the chancel have shafted inner jambs and moulded rear arches, and mask stops to the labels. There are two lancets in the south wall. In the north wall is a small recess with trefoil-arched head, all of modern stonework, possibly an Easter sepulchre. In the south wall is a piscina with pointed moulded arch and jambs. Beside it are three sedilia with moulded trefoiled arches and triple engaged shafts with moulded capitals and bases. The piscina and sedilia are of 13th-century date. A modern archway opens from the chancel into the south chapel. There is no chancel arch, but the lower roof of the chancel marks its western limit.

The three-light window in the east wall of the south chapel is of modern stonework, only the inner jambs and rear arch being old. The two windows in the south wall and the south doorway are all of modern stonework. The chapel is partly occupied by the organ. In the south wall is a piscina with continuously moulded arch and jambs.

The nave has north and south arcades of three bays of early 15th-century date, with pointed arches of two hollow-chamfered orders. The piers are of four semi-octagonal shafts separated by hollows. The capitals and bases are moulded. The moulded labels mitre with the string-course under the clearstory windows. The label stops on the side next the north aisle have never been carved. There are three clearstory windows on each side, each of two lights, much defaced. A small opening of modern stonework with cinquefoiled arch is pierced through the eastern respond of the south arcade; it opens into the south chapel, which extends westwards beyond the chancel.

The north aisle has east, west and two north windows, each of three traceried lights, all of modern stonework. The north doorway is of 15th-century date; it is of clunch, with moulded arch and jambs, the outer order forming a square head over the arch. The spandrels are traceried. The west label stop is carved with a head; the east one is uncarved. The

⁸⁴ Feet of F. Herts. Mich. 20 & 21 Eliz.; East. 25 Eliz.; Hil. 42 Eliz.; Recov. R. Hil. 41 Eliz. rot 24.

⁸⁵ *V.C.H. Herts.* i, 307.

⁸⁶ *V.C.H. London*, i, 423.

⁸⁷ Newcourt, *Repert.* i, 852.

⁸⁸ See account of Brent Pelham.

⁸⁹ *Hist. MSS. Com. Rep.* ix, App. i, 39a.

^{89a} *Visit. of Churches of St. Paul's* (Camden Soc.), 39-42.

⁹⁰ *Cal. Pat.* 1313-17, p. 190.

⁹¹ *Ibid.* 1321-4, pp. 52, 221.

⁹² *Ibid.* 1330-4, p. 531.

⁹³ Close, 1651, pt. xxiv, m. 27.

⁹⁴ Salmon, *Hist. of Herts.* 287.

⁹⁵ *V.C.H. London*, i, 430.



FURNEUX PELHAM CHURCH : THE NAVE ROOF



FURNEUX PELHAM CHURCH . FRAGMENT OF OAK SCREEN

EDWINSTREE HUNDRED FURNEUX PELHAM

stonework is defaced. In the south-east angle is a hollow-chamfered four-centred doorway to the rood stair, which still exists, as does also the upper doorway to the loft. In the south wall of the eastern respond of the arcade is a 15th-century piscina with cinquefoiled arch, continuously moulded, with stopped jambs.⁹⁶ The head is square and the spandrels are carved with roses and cusping.

The south aisle has two windows in the south wall and one window of three lights in the west wall, all of modern stonework, except the hollow-chamfered inner jambs of the easternmost window, which are original. The south doorway has continuously moulded arch and jambs, with square head over the arch. The traceried spandrels contain blank shields. A little to the west is a small doorway with pointed arch opening from the aisle to the stair leading to the room over the porch. The south porch has an east and west window, each of two cinquefoiled lights under a square head. The entrance archway is of modern stonework. In the north-east angle is a stoup with arched and cusped head, mutilated. The turret containing the stair to the room over the porch is on the west side. All the external stonework is modern. On one of the quoins of the porch is a roughly-cut sundial, about 9 in. in diameter, with Roman numerals. The room above the porch has a south window of three lights and a single west window, all of modern stonework. The single-light east window is original. The embattled parapet to the south aisle is badly mutilated and broken away. The north aisle has projecting eaves.

The west tower is of three stages with embattled parapet and slender leaded spire. The stair to the ringing chamber is in a circular turret at the south-west angle and is entered by a modern doorway on the west outside. The tower arch has two chamfered orders dying on square jambs. The west window is of three lights with traceried head; it has been repaired with cement. On the south wall in the second stage is an old clock dial with the figure of Time above, and underneath is the legend 'Time flies mind your business.' The belfry windows are each of two lights with traceried heads, partly of modern stonework.

The steep open roof of the chancel has a few old timbers in it. The nave roof is of 15th-century date. The tie-beams are moulded and rest on traceried brackets; the stone or wood corbels have gone. Two at the east end appear to be modern. The main timbers are moulded and have carved bosses

⁹⁶ It may have served for the altar of St. Katherine, which possibly stood at the east end of the north aisle, at which chantries were founded; see under advowson.

at their intersections; the cornice is embattled. At the feet of the principal rafters are figures of angels; those on the north side bear musical instruments or blank shields, those on the south side have shields all blank except the two most easterly, which bear emblazoned arms, but the colouring is indistinct. One bears quarterly, (1) and (4) a chief indented, (2) and (3) three birds. These arms also appear on John Newport's slab in the south chapel; the other shield bears a chevron between three crosslets fitchy impaling three birds as on the quartered shield. The roof timbers show many traces of coloured decoration. The roofs over the aisles are also of 15th-century

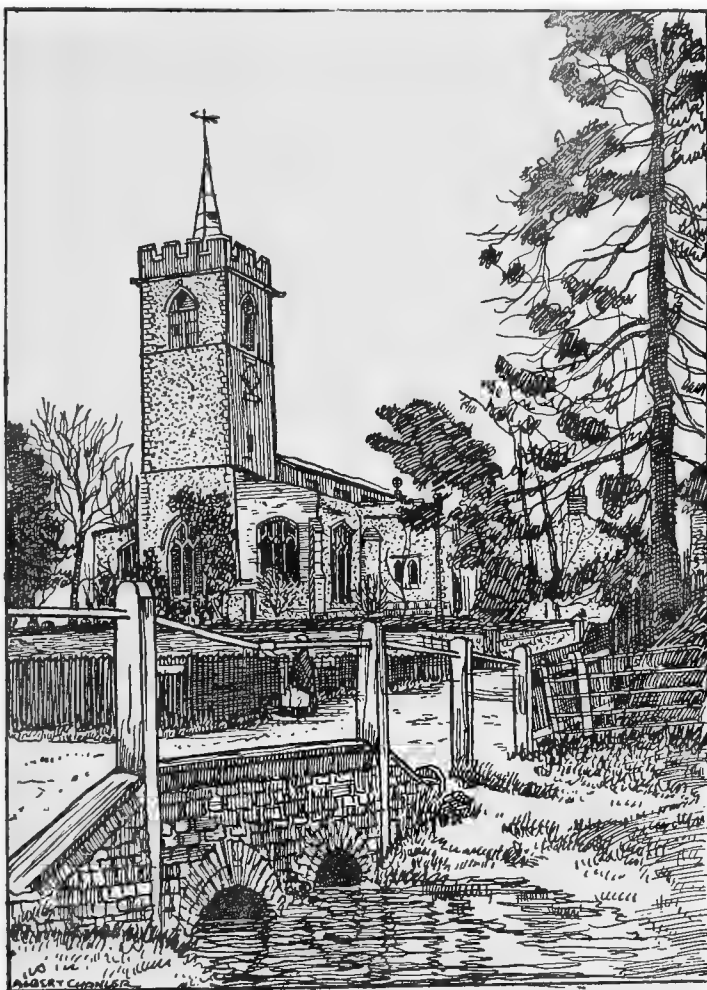

FURNEUX PELHAM CHURCH FROM THE SOUTH-WEST

date and have traceried brackets under the trusses. The roof over the south chapel dates from about 1500. The timbers are moulded and have carved bosses at their intersections and have also figures of angels. The spandrels are carved and rest on wood corbels, the cornice is embattled. The whole roof has been richly decorated in colour, the rafters still retaining red, white and blue colours, arranged in alternating cheverons.

The font has a 13th-century octagonal bowl of Purbeck marble. On each face are two shallow sinkings with pointed arches. The panelled clunch pedestal is of 15th-century date.

A HISTORY OF HERTFORDSHIRE

Lying loose in the church is a fragment of an oak screen; it is about 3 ft. 6 in. long and 13 in. high, and consists of portions of traceried heads of three panels of late 15th or early 16th-century date. In the centre of each is a carved shield with nondescript animals as supporters. The arms belong to the Newport family. The first bears a fesse between three crescents; the second, party a lion; the third, on a cross five leopards' heads. All these appear on John Newport's brass.

In the east window of the north aisle are some

(ob. 1434) and Cecilia his wife, the latter of whom died in 1477 and desired to be buried beside her husband in the chantry aisle of the church.⁹⁷ In the south chapel is an altar tomb of white stone with a black marble slab on the top; on the north side and west end are three shields of arms. On the wall above is a brass inscription to Edward Cason, 1624. On the floor of the chapel is a slab with indent of a knight in armour, and part of a marginal inscription to John Newport (1523) and a shield of arms. On the north wall of the north aisle are a

Purbeck marble tablet with small brasses of a man in armour, his wife, two sons and three daughters, all kneeling; a shield of arms: Party gules and azure a lion argent (Newport) impaling a bend engrailed between six billets (Alington); traces of colouring remain. There are also indents of the Virgin and Child, two shields and a scroll. The inscription is given by Weever⁹⁸: 'Here lyeth Robert Newport Esquy', founder of this chapel, and Mary his wyff, whych Robert dyed xvii of November, mcccccxviii.' On the floor of the south chapel are three slabs with indents. On a bracket on the wall of the chapel is a helmet of late 15th-century date.

There are six bells: the first by J. Warner & Sons, 1875; the second by T. Newman, 1723; the third by John Hods, 1662; the fourth a 16th-century bell inscribed 'Sancta Katerina Ora pro Nobis'; the fifth by Miles Graye, 1618; the sixth by J. Briant, 1792.

The communion plate consists of a cup and paten, 1835, and a flagon, 1876.

The registers previous to 1812 are as follows: (i) baptisms, burials and marriages 1560 to 1738; (ii) baptisms and burials 1739 to 1812, marriages 1739 to 1753; (iii) marriages 1754 to 1812.

The advowson of Furneux Pelham Church

belonged to the Treasurer of St. Paul's from the date of the endowment of his office with the church (see above). The church was visited among others belonging to the cathedral in 1252. The ministering chaplain was then in receipt of all the altarage and the small tithes and rendered 20s. a year to the treasurer. The church was found to be well thatched, but the graveyard was very ill-inclosed with old thorn bushes. Glass was wanting in two windows in the chancel. Within there were a high altar, four altars outside the quire and an altar of St. Nicholas. A stone font was sufficiently lined

⁹⁷ P.C.C. Wills, 28 Wattyra.

⁹⁸ *Funeral Monum.* 548.



FURNEUX PELHAM CHURCH: ROOF OF THE SOUTH CHAPEL

fragments of 15th-century glass. On a modern screen inclosing the vestry at the west end of the south aisle are the royal arms, carved in wood, bearing the dates 1634, 1660 and 1831.

At the west end of the south aisle is an altar tomb of Purbeck marble. The front and east end are panelled and traceried; each panel contains a shield with the indents of a brass. On the top are brasses of a man and his widow under a canopy, parts of which remain. There are indents of one daughter, four shields and inscription, probably of 15th-century date, and they possibly refer to William Newport

EDWINSTREE HUNDRED FURNEUX PELHAM

with lead. Only six books belonged to the church; one of them, an ill-bound volume, included certain offices of the saints which were proper to the use neither of Sarum nor of St. Paul's. The treasure consisted of a small chalice of white metal having a gilded cup, a tin chrisam, an old and vile pyx of bone, a little censer, four tin candlesticks and as many old phials, a small portable crucifix and several vestments, frontals and other cloths. There was a chest for the safe keeping of books and vestments. No rents of assize were received for lights and the church had no rowel-light. For the Easter waxlight a halfpenny was due from every 18 acres in the parish, but this money was collected fortuitously. The lights before crucifixes and altars depended entirely on offerings.⁹⁹ In 1291 the value of this poorly furnished church was £6 13s. 4d.¹⁰⁰ The parson in 1294 held with the benefice six others.¹ The church was again visited by the officers of the cathedral in 1297, when improved conditions were discovered. It was found to be consecrated to the Virgin. The graveyard was sufficiently inclosed and was clean, the windows adequately glazed and the nave and chancel well thatched, but the great staircase in the body of the church was defective. In the belfry there were two well-tuned² bells. There were separate seats, having suitable forms and lecterns. The altars were four or five in number, but one of them, which was of stone, had not been consecrated. In the nave there were images of the Crucifix, of the Virgin and of St. John, of two angels, St. John the Baptist, St. Michael, St. Thomas of Canterbury, St. Andrew, St. James, St. Mary Magdalen, St. Katherine and St. Margaret. The books, which were well bound, were eleven in number and included an ordinal of the Sarum use and a psalter, together with a legenda of the saints and a statute of Fulk, presumably Fulk Bassett, Bishop of London from 1244 to 1259. The treasure had since 1252 been increased by a chalice of silver-gilt, an ivory pyx, an enamelled portable crucifix, a copper sounce and several less valuable articles, including a vessel in which to burn charcoal in winter. The vestments and frontals were richer and more numerous. By Simon de Furneus the lights of the church had been endowed; the tenant of 5½ acres provided a lamp and three candles at St. Katherine's altar; two rents of 18d. were received, of which one maintained two torches to burn daily in the chancel at the elevation of the Host, and a rent of 2s. paid for a candle which was always kept burning in the chancel when the other lights had been extinguished.³ A third visitation made in 1458 found that the vicar of this date had in the time of his prosperity refused to visit sick parishioners, that the vicarage pigs had dug up the earth in the graveyard, that the chancel was partly unroofed owing to defective tiling and that the altar was worm-eaten. The books, far less various in character than in the 13th century, were four missals, three antiphoners, one ordinal, two manuals,

one grail, one legenda and two processional. Vestments and frontals were few. The treasure included two alabaster tablets representing the Passion of our Lord and that of St. Christopher.⁴ In 1535 the vicarage was of the annual value of £9.⁵ In 1552 the church still possessed no plate beyond a silver chalice, parcel-gilt, possibly that which existed in 1297. It had at this time four bells.⁶ Under the Commonwealth the income of Mr. Ball, minister of Furneux Pelham, was increased by £34, but such augmentation ceased when he was transferred to another living.⁷ The Treasurer of St. Paul's continued to be patron of the vicarage⁸ until it was united in 1771 to that of Brent Pelham.⁹

In 1306 Simon de Furneus received licence to grant certain lands in Brent and Furneux Pelham¹⁰ to the Prior and convent of Thremhall, who should in return maintain not only a chantry within their house, but also a chaplain to celebrate for the souls of Simon and his ancestors in Furneux Pelham Church.¹¹ The endowment was augmented in 1384 by a rent-charge on Furneux Pelham and Hixham Manors.¹² It was established in 1406 at St. Katherine's altar and its advowson was then conveyed with the manor.¹³ It is the only chantry in the church mentioned by the visitors of 1458, who stated that it had been founded for the souls of Ralph, Simon, Alice and Simon Furneus.¹⁴ In 1535 Furneus Chantry was of the annual value of £4.¹⁵ No certificate of it was returned in the following reign, presumably because it did not survive Thremhall Priory.

About the year 1237 William de Fauconberg, Treasurer of St. Paul's, with the consent of the Bishop of London and of the Dean and Chapter of the cathedral, granted that Simon de Furneus might build and have a chapel in his court at Furneux Pelham. All rights of baptism, burial and bells were safeguarded to the mother church.¹⁶ Soon afterwards there is reference to the chapel as built.¹⁷ It is probably that of which the advowson was afterwards held by the Bauds of Hadham Hall. In 1324 the king granted to Matthew Shanke the chantry of Furneux Pelham, forfeited by the rebellion¹⁸ of William Baud¹⁹; in 1327 the advowson of Furneux Pelham chapel was restored to William Baud,¹⁹ to whom, moreover, it was conveyed in 1331 by Simon Flambar, parson of Furneux Pelham, and John de Baud, parson of Corringham,²⁰ probably trustees for the purpose of securing William's right. There is no later reference to an advowson in Furneux Pelham held by the Bauds. The chantry may be one of the three all described, perhaps by an error, as situated at St. Katherine's altar in Furneux Pelham Church, of which the advowson was conveyed with the manor in 1406.²¹ This chantry appears soon afterwards to have become obsolete, if indeed it had at this date an existence which was more than traditional. In 1384 Richard de Sutton, kt. (see manor), and others received licence to found a chantry of one chaplain who should

⁹⁹ *Camden Misc.* (Camden Soc.), i, 18-20.

¹⁰⁰ *Pope Nich. Tax.* (Rec. Com.), 18.

¹ *Cal. Pat.* 1292-1301, p. 118.

² *Cordatis.*

³ *Visit. of Churches of St. Paul's* (Camden Soc.), 39-42.

⁴ *Ibid.* 105-6.

⁵ *Valor Eccl.* (Rec. Com.), i, 453.

⁶ *Visit. of Churches of St. Paul's* (Camden Soc.), 120.

⁷ *Cal. S. P. Dom.* 1654, p. 209.

⁸ *Inst. Bks.* (P.R.O.).

⁹ See account of Brent Pelham.

¹⁰ See account of Beeches Manor in Brent Pelham.

¹¹ *Cal. Pat.* 1301-7, p. 459.

¹² *Ibid.* 1381-5, p. 406, and see below.

¹³ Feet of F. Herts. 8 Hen. IV, no. 49.

¹⁴ *Visit. of Churches of St. Paul's* (Camden Soc.), 106.

¹⁵ *Valor Eccl.* (Rec. Com.), i, 453.

¹⁶ *Newcourt, Repert.* i, 854.

¹⁷ Doc. of D. and C. of St. Paul's, Liber A. Pilosus, fol. 18b.

¹⁸ *Cal. Pat.* 1324-7, p. 38.

¹⁹ *Cal. Close*, 1327-30, p. 22.

²⁰ Feet of F. Div. Co. 5 Edw. III, no. 8.

²¹ *Ibid.* Herts. 8 Hen. IV, no. 49.

A HISTORY OF HERTFORDSHIRE

celebrate daily at the altar of St. Katherine in Furneux Pelham Church for the souls of Sir John le Gros, his ancestors and benefactors and for all the faithful departed. The endowment was to consist of half an acre of land and its appurtenances in the parish and of an annual rent of £8 and 100 faggots of wood from the manors of Furneux Pelham and Hixham. The advowson was granted to the holder of Furneux Pelham Manor, with provision for the case of his default. An additional rent-charge of 40s. and of 200 faggots of wood was laid on the same two manors in order to increase the revenue of this chantry and also of that already existing in the church.²⁹ This latter payment, however, seems to have been devoted entirely to the Gros Chantry and the rent-charge of 40s. to have lapsed at the Dissolution. The total rent of £10 payable to chantries was again granted by Thomas Bideford when he acquired the two manors in 1387-8.²⁹

It appears that the chantry thus founded in 1384 was soon afterwards transferred to a chapel outside the church, probably that built by Simon de Furneux. In 1387-8 the chantry of Sir John le Gros was in the chantry chapel of Furneux Pelham.²⁴ The description of it, therefore, in 1406, when its advowson was conveyed with the manor, as situated at the altar of St. Katherine in the church,²⁵ seems to be an outcome of the terms of its foundation. The Gros Chantry was in 1535 said to be worth £8 a year.²⁶ When it was dissolved in the following reign it was described as situated in a chapel distant by more than a furlong from the parish church. Its endowment then consisted of a yearly rent of £8 from the manors of Furneux Pelham and Hixham, of four loads of wood granted annually from those manors

for the priest's fuel and worth 3s., and of a tenement and half an acre of land known as the Chaumbre Howse and occupied by the incumbent.²⁷ The tenement called Le Chantry House was granted by the Crown to Robert Wood in 1549,²⁸ and in 1617 John Gray received a grant of two chantries called Gros Chantry and Le New Chantry.²⁹ The latter term probably referred rather to an appurtenance of the chantry chapel than to Furneux Chantry. The income of Gros Chantry continued to be reserved in conveyances of the manors burdened with it. Edward Newport in 1678 rendered four loads of wood from Furneux Pelham Manor to the trustees for the payment of pensions.³⁰ A separate conveyance of the rent of £8 was made in 1689.³¹ It was in 1813 held to be payable from Hixham Manor only and was reserved in the sale of that date.³²

In 1724 Mary Wheatly, by her *CHARITIES* will, devised 2 acres and three cottages adjoining of copyhold tenure for the support of a charity school. The rents, amounting to £9 a year or thereabouts, are applied for educational purposes in connexion with the school.

Mrs. Sarah Yarrington, who died in 1746, left the interest of £100 Old South Sea Annuities for the putting out of poor boys as apprentices. The legacy, with accumulations, is now represented by £149 12s. 4d. consols, producing yearly £3 14s. 8d., which is paid to the school account.

In 1774 Francis Caryl bequeathed £200, the interest to be expended in the distribution of bread. The legacy is now represented by £259 16s. consols, producing £6 9s. 8d. yearly, which is distributed in bread.

The sums of stock are held by the official trustees.

STOCKING PELHAM

Pelham Parva, Stoke Pelham (xiii cent.); Stokkene-pelham (xiv cent.); Stocking Pelham (xv, xvi and xvii cent.).

This small parish has an area of only 647 acres, of which nearly three-quarters are arable land, just over one-quarter permanent grass and 14 acres woods and plantations.¹ The soil is heavy and the subsoil clay. The highest ground is near the church and Stocking Pelham Hall, where it is 41 1½ ft. above the ordnance datum, and the lowest, which is 323 ft. above the same datum, is at the southern end of the parish.

The most important road branches off in Furneux Pelham parish from the Hadham road and after passing through the village crosses Stocking Pelham diagonally and leads north-east into Berden parish in Essex. From a point in this road another and winding way leads north-westwards into Brent Pelham parish. On the north side of this road are the church and moated manor-house known as Stocking Pelham Hall, now the property of Mr. E. E. Barclay of Brent Pelham. The Cock Inn is a timber-framed and plastered house of two stories; the roof is

tiled. It is of late 16th or early 17th-century date. The chimney stacks are plain and are built of thin bricks. In the taproom is a plain wide fireplace and the ceiling has splayed and stopped beams and floor joists. The rectory lies north-west of the village and is surrounded by a moat. There is also a fragment of another moat on the north-east side of the church.

In the 15th century Wildenwodes, Nydelys and Renelys occur as names of places in Stocking Pelham Manor,² and in the 16th century a tenement is described as near Este Road,³ which may perhaps be rendered East Road.

The lands of Stocking Pelham as sur-*MANOR* veyed in Domesday cannot be distinguished from those of the other Pelhams. All the lands in this parish were held of the Bishop of London in 1086 and afterwards.⁴

Between 1210 and 1212 Thomas de Bideford held 2 hides and 16 acres of land, presumably in *STOCKING PELHAM*, of the Bishop of London for the service due from one knight's fee.⁵ His successor later

²⁹ Chan. Inq. p.m. 7 Ric. II, no. 156; *Cal. Pat.* 1381-5, p. 406.

²⁸ Close, 11 Ric. II, pt. i, m. 19 d.

²⁷ Ibid. 10 Ric. II, m. 27, 28, 29 d.

²⁶ Feet of F. Herts. 8 Hen. IV, no. 49.

²⁵ *Valor Eccl.* (Rec. Com.), i, 453.

²⁴ Chan. Cert. 20, no. 71; 27, no. 10.

²³ Pat. 3 Edw. VI, pt. vii.

³² Ibid. 15 Jas. I, pt. xiv.

³¹ Duchy of Lanc. Misc. Bks. lxxii, fol. 59 d.

³⁰ Feet of F. Herts. Mich. 1 Will. and Mary.

²⁹ Com. Pleas D. Enr. East. 53 Geo. III, m. 28.

¹ Statistics from Bd. of Agr. (1905).

² Close, 12 Hen. IV, m. 8.

³ Chan. Cert. 27, no. 36.

⁴ See account of Brent Pelham; *Plac. de Quo Warr.* (Rec. Com.), 290.

⁵ *Red Bk. of Exch.* (Rolls Ser.), 541. Thomas's surname is wrongly given as Wiford.

EDWINSTREE HUNDRED STOCKING PELHAM

in this century was Jordan de Bideford,⁶ whose heirs were said in 1303 to hold half a knight's fee in Stocking Pelham of the bishop.⁷ The actual tenant was probably Richard de Bideford, who with his wife Agnes niece of Thomas de Wauncy occurs in 1278.⁸ He may have had for his successor Richard de Bideford, who settled Stocking Pelham Manor in 1331 on himself and his wife Alice in tail-male, with remainder to his brother Henry.⁹ In 1350 Richard de Bideford and Richard his son were amongst the trustees for a settlement of Chamberleyns Manor in Brent Pelham.¹⁰ The younger Richard probably succeeded to the elder and was identical with Sir Richard Bideford, kt., from whom before 1411 the manor of Stocking Pelham passed to his daughter Joan.¹¹ She married Henry Hert, citizen and cloth-maker of London, to whom and herself John son and heir of Thomas Bideford, perhaps the heir male of Sir

Between 1483 and 1485 the legality of this transaction was disputed by Richard son and heir of Thomas Rous, who claimed to be reversionary heir under settlements made by Richard Bideford, Joan Hert and his father. He stated that John and James Songer had taken advantage of his father's 'great and feeble age of eighty years' to the undoing of himself and of his children, 'which be many in number.'¹⁶ Richard Rous lost his case and James Songer held the manor as late as 1499.¹⁷ In 1509 the holder was Anne Songer and in 1518 Richard Songer,¹⁸ who were probably James's widow and heir respectively. In 1541 Richard son and heir-apparent of Richard Songer seems to have conveyed his reversionary interest to Jeremy Songer.¹⁹ The manor was settled in 1542 on the elder Richard for his life, with remainder to Jeremy and Mary Grene, probably his betrothed wife, and to Jeremy's heirs.²⁰ Further



STOCKING PELHAM CHURCH FROM THE SOUTH-EAST

Richard, released the manor in 1410-11.¹² Henry Hert held the lands in Stocking Pelham in his wife's right in 1428¹³ and in 1436.¹⁴ Her heir was Thomas Rous, who within her lifetime and about the year 1443 married a certain Joan. At this time or afterwards Joan Hert devised to him the reversion of the manor, and some time after 1456¹⁵ he duly succeeded her. From about the year 1450 the manor was in lease to John Songer, whose son and heir James bought the reversion in fee after the death of Thomas Rous.

settlements were made by Jeremy Songer and Mary his wife in 1546²¹ and 1553.²² In 1551 Jeremy leased the manor to John Growte for fifty years²³ and apparently again settled it in 1555²⁴ and 1557.²⁵ In 1570 the manor of Stocking Pelham had come to an heiress, Dorothy wife of Edmond Huddleston, who with her husband settled it on their son John Huddleston.²⁶ Edmond Huddleston, who was knighted in 1579,²⁷ settled the manor in 1593²⁸ and died in 1606. In accordance with various settlements the

⁶ Jordan held the fifth part of a knight's fee in Thameworth, Oxon. (*Testa de Nevill* [Rec. Com.], 1066).

⁷ *Feud. Aids*, ii, 431.

⁸ Herts. and Hants Assize R. Edw. I (Agarde's Index), fol. 52.

⁹ Feet of F. Herts. 5 Edw. III, no. 77.

¹⁰ Add. MS. 5806, fol. 14 d.

¹¹ Early Chan. Proc. bdlc. 65, no. 54.

¹² Close, 12 Hen. IV, m. 8.

¹³ *Feud. Aids*, ii, 446.

¹⁴ See account of chantry.

¹⁵ Newcourt, *Repert.* i, 866.

¹⁶ Early Chan. Proc. bdlc. 65, no. 54.

¹⁷ Newcourt, *op. cit.* i, 867. ¹⁸ *Ibid.*

¹⁹ Feet of F. Herts. Trin. 33 Hen. VIII.

²⁰ *Ibid.* Trin. 34 Hen. VIII.

²¹ *Ibid.* Trin. 38 Hen. VIII.

²² *Ibid.* East. 7 Edw. VI.

²³ Chan. Proc. (Ser. 2), bdlc. 170, no. 59.

²⁴ *Recov. R. Hil.* 2 & 3 Phil. and Mary, rot. 457.

²⁵ Feet of F. Herts. East. 3 & 4 Phil. and Mary.

²⁶ *Ibid.* East. 12 Eliz.

²⁷ Metcalfe, *Book of Knights*, 133.

²⁸ Feet of F. Herts. Trin. 35 Eliz.

A HISTORY OF HERTFORDSHIRE

manor devolved on his wife Dorothy for life, and afterwards on his son Henry and Henry's wife Dorothy for their lives, with remainder to Henry's heirs male.^{28a} Henry with his son and heir, Sir Robert Huddleston, kt., made settlements of the manor in 1613 and 1621, probably for the purpose of barring the entail.²⁹ In 1627 Henry Huddleston conveyed the manor to Thomas Nightingale, who was created a baronet in 1628 and died in 1645.³⁰ In accordance with his will the manor was sold in 1649 to William Webb of Gray's Inn, who was succeeded by his son Richard. The latter in 1681 bequeathed it in tail-male to his brother Jonathan.³¹ Further settlements were made and the entail barred by Jonathan Webb and Elizabeth his wife and their son Christopher in 1704,³² 1707,³³ and 1708.³⁴ Christopher with his sister Jane Webb, their father being dead, conveyed the manor in 1709 to William Calvert of Furneux Pelham Hall,³⁵ and for the succeeding century and a half it was held with Furneux Pelham Hall³⁶ (q.v.). In 1859 the executors of General Felix Calvert of Furneux Pelham Hall sold Stocking Pelham to John Mott Richardson of Much Hadham, who was lord of the manor in 1859³⁷ and whose rights have descended to Mr. Charles Board Richardson.

The church of *ST. MARY THE CHURCH VIRGIN* consists of chancel 26 ft. by 15 ft. 6 in., nave 34 ft. 6 in. by 23 ft. 6 in., with bellcote on the west end of the roof and modern

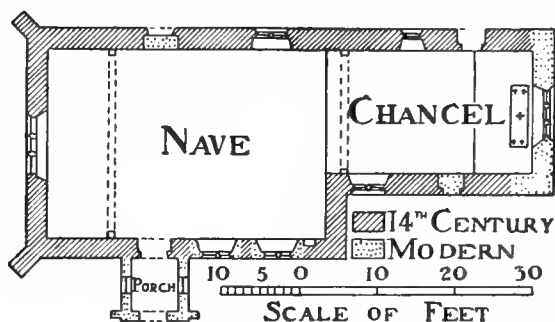

PLAN OF STOCKING PELHAM CHURCH

south porch, all the dimensions being internal. The walls are of flint with stone dressings, except the east wall of the chancel, which is of brick. Parts of the walls are cemented; the nave roof is slated and the chancel roof tiled.

The north walls of chancel and nave are in the same plane, the extra width of the nave being all on the south side. The earliest details belong to the middle of the 14th century, and as work of that period exists on the north and south walls of both chancel and nave it is not easy to determine the steps by which the church arrived at its present somewhat unusual plan. It is probable, however,

that a small earlier building existed, the walls of which were partly made use of in the 14th century. That the additional width on the south side of the nave was never an aisle seems evident, as the west window is central and the north and south walls are of equal height. In 1864 the east and part of the south walls were rebuilt in brick.

In the east wall of the chancel is a modern three-light traceried window. In the north wall is a single-light window with cinquefoiled head and with wave-moulded inner jambs and arch; it is of mid-14th-century date. In the same wall is a doorway of clunch, which appears to have been the entrance to a former vestry, as the rear arch is on the outside. In the south wall is a window of two lights under a square head, with tracery of 14th-century date; it has been repaired with cement. Adjoining it is a south doorway, now blocked. The chancel arch is a modern one of wood.

The nave has a mid-14th-century north window of two lights with flowing tracery, partly restored; the blocked north doorway is of the same date, but much of the stonework is modern. In the south wall are two windows of modern stonework, each of two lights with tracery of 14th-century character. The south doorway is of modern stonework, except the inner jambs, which are original. In the south wall, near the east end, is a 14th-century piscina with cusped arch. At the west end of the nave is a timber framework which partly supports the wooden bellcote on the roof. The west window has three traceried lights, all of modern stonework; the inner jambs and rear arch are original. The ceilings of chancel and nave are plastered. The porch is modern.

In the nave is a slab with a brass shield bearing a 15th-century merchant's mark³⁸ and the indent of an inscription; on the south side, under the seats, is a slab with indent of the half-figure of a priest. In the south window of the chancel are a few fragments of old glass.



15TH-CENTURY MERCHANT'S MARK

There is one bell inscribed 'Vincencius Reboat ut Cuncta Noxia Tollat,' early 15th century.

The communion plate is modern.

The registers previous to 1812 are as follows: (i) baptisms and burials 1695 to 1812, marriages 1695 to 1753; (ii) marriages 1754 to 1812.

The advowson of Stocking Pelham *ADVOWSON* rectory passed with the manor from the earliest times on record until the 19th century.³⁹ In 1556 and 1557 John Growte, who was lessee of the manor,⁴⁰ presented, and presentments by Robert Marshal in 1370 and by Thomas

^{28a} Chan. Inq. p.m. (Ser. 2), cccxxix, 174.

²⁹ Feet of F. Div. Co. Hil. 10 Jas. I; Div. Co. Mich. 19 Jas. I; Recov. R. Mich. 19 Jas. I, rot. 11.

³⁰ Recov. R. Hil. 2 Chas. I, rot. 75; G.E.C. *Baronetage*, ii, 53.

³¹ Clutterbuck, *Hist. of Herts.* iii, 459.

³² Recov. R. Trin. 3 Anne, rot. 264.

³³ Com. Pleas D. Enr. Mich. 6 Anne, m. 6 d.; Recov. R. Mich. 6 Anne, rot. 147.

³⁴ Com. Pleas D. Enr. East. 7 Anne, m. 11.

³⁵ Clutterbuck, loc. cit.

³⁶ See account of Furneux Pelham; Recov. R. Hil. 33 Geo. II, rot. 183.

³⁷ Cussans, *Hist. of Herts. Edwinstree Hund.* 156.

³⁸ This was probably the mark of Henry Hert (Heart). See above under manor and under advowson. The flag is suggestive of a clothmaker.

³⁹ Feet of F. Herts. 5 Edw. III, no. 77; Trin. 33 Hen. VIII; Trin. 34 Hen. VIII; East. 3 & 4 Phil. and Mary; East. 12 Eliz.; Trin. 35 Eliz.; Div. Co. Hil. 10 Jas. I; Mich. 19 Jas. I; Close, 12 Hen. IV, m. 8; Early Chan. Proc. bdle. 65, no. 54; Recov. R. Mich. 19 Jas. I, rot. 11; Hil. 2 Chas. I, rot. 75; Inst. Bks. (P.R.O.).

⁴⁰ See above.

Melman and his wife Joan from 1451 to 1452⁴¹ must have been in right of leases or other limited conveyances. The right of patronage was exercised for the last time by the lord of the manor in 1832.⁴⁹ Mr. J. Chalmers-Hunt is the present patron.

In 1291 this church was of the annual value of £3 6s. 8d.⁴³ and at the time of the dissolution of religious houses the rectory was worth £7 10s. 7d. a year.⁴⁴ In 1610 the glebe consisted of about 106 a. 15 r. of land, besides certain lands in Waxed within the parish.⁴⁵ In 1650 the Parliamentary Commissioners reported that the yearly value of the rectory was £50.⁴⁶

At the date of the dissolution of gilds and chantries a yearly rent of 2s. was paid to the church for the keeping of an obit and of a light about the Easter sepulchre.⁴⁷

A perpetual chantry was founded in 1436 by Henry Hert in a chapel in Stocking Pelham about 2 furlongs distant from the parish church. Its clear annual value at the time of the dissolution of religious houses was said to be £5 6s. 8d.⁴⁸ When itself dissolved its endowment was declared to consist of a rent of £5 13s. 4d. received from certain lands in Brent Pelham held with Stocking Pelham Manor, and of a rent of 12s. from a tenement called the 'Chaumbre Howse' and an acre of land which were occupied by the incumbent, an aged man who depended entirely on the income of the chantry.⁴⁹ Its goods and chattels were worth 2s. 10d.⁵⁰ In 1549 the tenement in Stocking Pelham called the Chantry House and the garden which adjoined it were granted to John Perient.⁵¹

There are no endowed charities in this parish.

THROCKING

Troching (xi cent.); Trocking (xii cent.); Tockringe, Throckinge (xiii cent.); Throcking, Thorking (xiv cent.); Throcking *alias* Thorling (xvi cent.).

The parish of Throcking contains 1,048 acres. About one-half of this is arable land and one-sixth permanent grass. There is very little woodland.¹ The soil is mixed, generally stiff, on a subsoil of clay with some gravel, and this again stands on gravel. In the west of the parish the land rises to nearly 500 ft. above ordnance datum, falling to 333 ft. in the north-east, where the River Rib for a short distance flows through the parish.

The village of Throcking is very small. In 1428 there were only eight inhabitants.² Ermine Street forms the eastern boundary of the parish, and the village church lies south of a road which branches west from this and passes through the parish to Cottered, where it joins the road to Baldock. It is on the high ground in the west of the parish and close to it is Throcking Hall. The rectory was built about 1841 on a site given by John Ray, lord of the manor. For some years before this date there had been no house belonging to the rectory in the parish, the one built by Robert Elwes about the beginning of the 18th century having disappeared before 1808.³ The road from Buntingford to Baldock forms for some distance the southern boundary of Throcking.

In the time of Edward the Confessor *MANOR* 1 hide and a virgate of land in Throcking were held of Archbishop Stigand by two sokemen.⁴ After the Conquest this holding was acquired by Hardwin de Scales and was held of him

by Theobald.⁵ The Scales overlordship appears later when in the early 14th century the manor of Throcking was said to belong to the fee of Chalers or Scales.⁶

Before 1217-18 a subfeoffment of the manor had been made by the Fitz Ralphs, the descendants of the Domesday tenant Theobald.⁷ Ralph Fitz Ralph appears as lord of the fee at the end of the 13th century,⁸ and in 1303⁹ and in 1328¹⁰ his son William Fitz Ralph was overlord. After this date there is no further record of this family holding rights in Throcking.

The earliest known sub-tenant in the manor of Throcking is Roger Fitz Brian, who was holding the advowson of Throcking in 1217-18.¹¹ With his wife Maud he granted 2 carucates of land in Throcking and Hoddenhoo (in Therfield, Odsey Hundred) to the priory of Holy Trinity or Christchurch, London, and this grant was confirmed by Henry III in February 1226-7.¹² Brian de Throcking appears as witness to deeds about the middle of the same century.¹³ By 1292 the manor had descended to Roger Brian, who granted 2 acres of land and 100s. rent in Hinxworth, Throcking, Clothall and Aspenden to found a chantry in the chapel of St. John the Baptist of Buntingford.¹⁴ He was holding the manor in 1303,¹⁵ but he must have died before 1307, when John de Argentine, the husband of his daughter and heir Joan,¹⁶ received a grant of free warren in Throcking.¹⁷ John died in 1318 and his wife Joan apparently predeceased him.¹⁸ Her two daughters, Joan and Elizabeth, were her heirs.¹⁹ They were married before 1326 to John and William Boteler, the sons of Ralph Boteler of Pulverbatch and Norbury,²⁰ who presented to the church in

⁴¹ Newcourt, *op. cit.* i, 856.

⁴² Cussans, *op. cit.* 158.

⁴³ *Pope Nich. Tax.* (Rec. Com.), 20.

⁴⁴ *Valor Eccl.* (Rec. Com.), i, 452.

⁴⁵ Newcourt, *op. cit.* i, 856.

⁴⁶ Cussans, *op. cit.* *Edwinstree Hund.*

157.

⁴⁷ Chant. Cert. 27, no. 36.

⁴⁸ *Valor Eccl.* (Rec. Com.), i, 453.

⁴⁹ Chant. Cert. 27, no. 11.

⁵⁰ *Ibid.* 20, no. 69.

⁵¹ Pat. 3 Edw. VI, pt. vii.

¹ Statistics from Bd. of Agric. (1905).

² *Feud. Aids*, ii, 454, 458.

³ See Cussans, *op. cit.* *Edwinstree Hund.*

114.

⁴ *V.C.H. Herts.* i, 340a.

⁵ *Ibid.*

⁶ De Banco R. 273, m. 75 d. Another part of the manor consisted of the fee of Vabadun, see below.

⁷ For the descent of the Fitz Ralphs see the manor of Broadfield in Odsey Hundred.

⁸ See De Banco R. 273, m. 75 d.

⁹ *Feud. Aids*, ii, 431.

¹⁰ De Banco R. 273, m. 75 d.

¹¹ Feet of F. Herts. 2 Hen. III, no. 2.

¹² Dugdale, *Mon.* vi, 153.

¹³ Anct. D. (P.R.O.), A 1175, 1028.

¹⁴ Chan. Inq. p.m. 20 Edw. I, no. 119; *Cal. Pat.* 1281-92, p. 486.

¹⁵ *Feud. Aids*, ii, 431.

¹⁶ Wrottesley, *Ped. from Plea R.* 64.

¹⁷ *Cal. Chart. R.* 1300-26, p. 107.

¹⁸ *Cal. Inq. p.m.* 10-20 Edw. II, 104; *Cal. Close*, 1318-23, p. 50.

¹⁹ Wrottesley, *Ped. from Plea R.* 64; see De Banco R. 273, m. 75 d. The daughters are here called Joan and Matilda.

²⁰ Wrottesley, *loc. cit.*; Chester Waters, *Chesters of Chicheley*, 139.

A HISTORY OF HERTFORDSHIRE

that year.³¹ Joan and Elizabeth were still minors in 1328.³² In 1336 Elizabeth Boteler with her husband William made a settlement of the manor.³³ William Boteler died before his wife, who took as her second husband Gilbert de Elsfield, who held the manor and presented to the church in 1349.³⁴ Elizabeth survived this husband also, and in 1376 as Elizabeth de Elsfield she presented to the church herself.³⁵ She must have died shortly afterwards, leaving no issue,³⁶ and her lands passed to the heirs of Joan her sister. Joan had two sons, Ralph, who died while still a minor in 1348, and Edward,³⁷ who was aged twenty-one in 1360³⁸ and was holding the manor in 1379, when he presented to the church.³⁹ Edward Boteler is said to have conveyed the manor to William Hyde, citizen and grocer of London, about 1395.⁴⁰

In 1414 William Hyde presented to the church⁴¹ and he was still holding the manor with his wife Joyce in 1437.⁴² By 1462 it had descended to George Hyde,⁴³ who was living as late as 1470.⁴⁴ His widow Agnes Hyde presented to the church of Throcking in 1472.⁴⁵ Robert Hyde is mentioned as lord of the manor of Throcking in 1486.⁴⁶ It descended to Leonard Hyde, who left it by his will, proved in February 1508-9, to his son George.⁴⁷ George had a son Leonard, who died before his father in 1549,⁴⁸ and on George's death in 1553⁴⁹ the manor descended to his grandson William, the son of Leonard.⁵⁰ In 1561 William Hyde conveyed it by lease and release to his uncle William, another son of George Hyde.⁵¹ A claim was made on the manor by Thomas Wiseman, who appears to have had a mortgage on it. Although the elder William retained the manor, he felt it necessary in his will to declare that the deeds of sale were no forgery.⁵² He died in 1580 and his son Leonard, who inherited his lands,⁵³ received a quitclaim of all right in Throcking Manor from his cousin William Hyde⁵⁴ and from Thomas Wiseman⁵⁵ in 1583. William Hyde died in 1590⁵⁶ and his widow Mary immediately claimed dower from the manor of

Throcking. An annuity of £60 was granted to her and also an annual payment of £20 to her son Nicholas.⁵⁷ Leonard Hyde was knighted by James I before his coronation in 1603.⁵⁸ Chauncy accuses him of paving his kitchen at Sandon with the grave-stones from Throcking Church and of sequestrating all the church property.⁵⁹ It is a curious fact that no memorials to the Hydes now remain, although they were all buried in Throcking Church.⁶⁰ By Sir Leonard's will, proved in 1624, the manor descended to his son Robert,⁶¹ who sold it to Thomas Soame in 1630.⁶² Thomas Soame was knighted in 1641.⁶³ In 1670 he sold the manor to Robert Raworth,⁶⁴ whose daughter Frances married Jeremy Elwes⁶⁵ and inherited the manor on her father's death. Frances Elwes died in 1678,⁶⁶ when Throcking passed to her son Jeremy Elwes.⁶⁷ The latter died without issue in 1683,⁶⁸ when his brother Robert succeeded to his lands.⁶⁹ In 1731 Robert Elwes died and Throcking descended to his son of the same name,⁷⁰ who held it until his death in 1752, when it passed to his son Cary Elwes.⁷¹ In 1781 Cary Elwes with his only son by his first marriage, Cary Elwes the younger,⁷² settled the manor.⁷³ This son died in that year and on the death of Cary Elwes the elder in 1782 the only son of his second marriage, Robert Cary Elwes, was his heir.⁷⁴ In 1799 Robert Cary Elwes sold the manor to George Wood,⁷⁵ by whose executors it was sold to John Ray of Finchley in 1817.⁷⁶ After the death of John Ray in 1840 his lands in Throcking were sold in separate parcels by his executors and the manorial rights were allowed to lapse.⁷⁷

There was a mansion-house on the manor of Throcking in 1549, when it is mentioned in the will of George Hyde.⁷⁸ In 1692 Robert Elwes, then lord of the manor, built a new house, which Chauncy describes as 'a curious and neat fabric.'⁷⁹ Robert (ob. 1731) left it by his will to his grandson Cary Elwes, son of his son Robert, in tail-male.⁸⁰ Robert the father of Cary endeavoured to persuade

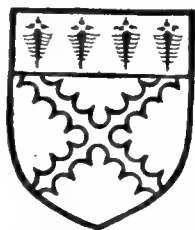

HYDE of Throcking.
Gules a saltire engrailed
or and a chief ermine.

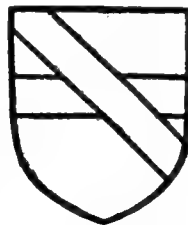

ELWES. Or a fesse
azure with a bend gules
over all.

³¹ Clutterbuck, *Hist. and Antiq. of Herts.* iii, 466.

³² De Banco R. 273, m. 75 d.

³³ Feet of F. Herts. East. 10 Edw. III, no. 161.

³⁴ See Clutterbuck, loc. cit.; *Feud. Aids*, ii, 446.

³⁵ Clutterbuck, loc. cit.

³⁶ R. E. C. Waters, loc. cit.

³⁷ Chan. Inq. p.m. 34 Edw. III (1st nos.), no. 39; see R. E. C. Waters, loc. cit.

³⁸ Chan. Inq. p.m. 34 Edw. III (1st nos.), no. 39.

³⁹ Clutterbuck, loc. cit.

⁴⁰ Chauncy, *Hist. Antiq. of Herts.* 117. Cussans gives 1398 as the date of this sale (Cussans, *Hist. of Herts. Edwinstree Hund.* 109).

⁴¹ Clutterbuck, loc. cit.; see *Feud. Aids*, ii, 446. Chauncy mentions a Lawrence Hyde living in 1433, but he does not appear to have held the manor. See Chauncy, loc. cit.

⁴² Feet of F. Div. Co. East. 15 Hen. VI, no. 9.

³⁸ See Clutterbuck, loc. cit.

³⁴ Anct. D. (P.R.O.), D 519.

³⁵ Clutterbuck, loc. cit.

³⁶ Chan. Inq. p.m. (Ser. 2), xxiii, 65.

³⁷ Cussans, *Hist. of Herts. Odsey Hund.* 151.

³⁸ *Ibid.* 153.

³⁹ His will was proved in 1553, see Cussans, loc. cit.

⁴⁰ See Chan. Proc. (Ser. 2), bde. 211, no. 27.

⁴¹ *Ibid.*; see also Chan. Inq. p.m. (Ser. 2), cxcii, 69; Ct. of Req. bde. 63, no. 54 (34 Eliz.).

⁴² Cussans, loc. cit.

⁴³ Chan. Inq. p.m. (Ser. 2), cxciii, 69.

⁴⁴ Feet of F. Herts. Trin. 25 Eliz.

⁴⁵ *Ibid.*

⁴⁶ See Ct. of Req. bde. 63, no. 54 (34 Eliz.).

⁴⁷ *Ibid.*

⁴⁸ Shaw, *Knights of England*, ii, 120.

⁴⁹ Chauncy, op. cit. 117.

⁵⁰ *East Herts. Arch. Soc. Trans.* iii, 154; see Cussans, loc. cit. for wills of Hydes.

⁵¹ Cussans, loc. cit.

⁵² *Recov. R. Trin. 6 Chas. I, rot. 43.*

⁵³ Shaw, *Knights of England*, ii, 211.

⁵⁴ Feet of F. Herts. Mich. 22 Chas. II.

⁵⁵ M.I.

⁵⁶ Clutterbuck, *Hist. and Antiq. of Herts.* iii, 465.

⁵⁷ Chauncy, loc. cit.

⁵⁸ Clutterbuck, loc. cit.

⁵⁹ Chauncy, loc. cit.; *Recov. R. Hil. 4 Geo. I, rot. 43.*

⁶⁰ M.I.; *Recov. R. Mich. 16 Geo. II, rot. 177.*

⁶¹ Clutterbuck, loc. cit.

⁶² *Ibid.*

⁶³ *Recov. R. Hil. 21 Geo. III, rot. 347.*

⁶⁴ Clutterbuck, loc. cit.; *Recov. R. Mich. 34 Geo. III, rot. 373.*

⁶⁵ Clutterbuck, loc. cit.

⁶⁶ *Ibid.*

⁶⁷ Cussans, *Hist. of Herts. Edwinstree Hund.* 108.

⁶⁸ *Ibid. Odsey Hund.* 153.

⁶⁹ Chauncy, loc. cit.

⁷⁰ Cussans, *Hist. of Herts. Edwinstree Hund.* 109.

his brother Jeffrey to bar the entail, as Cary had no children. Jeffrey's refusal gave rise to a quarrel, and, to spite Jeffrey, in 1744 Robert and his son Cary pulled the house down.⁷¹ They were, however, premature, for subsequently Cary married twice and had two sons.⁷² The foundations of the old house may still be traced in a meadow called the Pightle, which lies to the south of the church. There are the remains of an old brick wall, and a deep depression in the ground appears to denote the position of the cellars. Near by is a moat, which probably ran round the house, but it is very much overgrown and nearly dry in summer-time.⁷³ Traces of a path which led from the house to the south porch of the church are also to be found.⁷⁴ The modern house known as Throcking Hall or Hall Farm stands a little to the east of the foundations of the older house.

Two carucates of land in Hoddenhoo and Throcking were granted to the priory of Holy Trinity, London, by Roger Fitz Brian, lord of the manor of Throcking, and confirmed by Henry III in February 1226-7.⁷⁵ In 1287 the prior's men in Throcking and Sandon were charged with the repair of the bridges of Corneybury and Pope's Hall on the one side of the river, the other side being undertaken by his men in Alfadewick.⁷⁶

Before the Conquest two men of William Bishop of London held land in Throcking which was assessed at $1\frac{1}{2}$ hides and was of the king's soke. One virgate of it was in mortgage.⁷⁷ In 1086 these lands were held of the Bishop of London by a tenant Humphrey.⁷⁸ One virgate of it was still in mortgage. Humphrey paid the king's geld on it, but was not in possession.⁷⁹ The Bishop of London's lands in Throcking are mentioned in 1278, when the bishop claimed that his tenants there and elsewhere should be free from suit of hundred court,⁸⁰ but no further record of them occurs after that date. It is possible that part of the bishop's lands had been granted to the family of Vabadun, for in 1217-18 Richard de Vabadun had rights over half the advowson of Throcking, which he conveyed to Roger Fitz Brian, lord of the manor of Throcking.⁸¹ The lands of the Vabaduns were also apparently acquired by the Fitz Brians, for in the early 14th century part of the manor of Throcking was known as the fee of Vabadun in distinction to the fee of Challers.⁸²

Besides the lands of the Bishop of London and Hardwin de Scales, there were two other small holdings in Throcking in 1086. One of these comprised 18 acres. It had been held of Archbishop Stigand by Alric.⁸³ At the Norman Conquest it was added to the possessions of Count Eustace of Boulogne, of whom it was held by Rumold.⁸⁴ Nothing further

can be traced of this holding under Throcking and it was possibly attached to Rumold's manor of Beauchamps in Layston (q.v.). There was another small piece of land, comprising 12 acres, which in the time of Edward the Confessor was held by Alvic Scova.⁸⁵ In 1086 it had been acquired by the Bishop of Bayeux and was held of him by Osbern.⁸⁶ This fee also cannot be traced after 1086 and it was probably appurtenant to a larger holding.

The church of *HOLY TRINITY CHURCH* consists of chancel 19 ft. 6 in. by 18 ft., modern north vestry, nave 31 ft. by 18 ft., south porch 8 ft. by 6 ft. 6 in. and west tower 8 ft. 9 in. square; all the dimensions are internal. The walls are of flint rubble covered with cement and with stone dressings. The upper half of the tower is of red brick. The roofs, which are continuous over chancel and nave, are slated.

The lower half of the tower is the earliest part of the building and dates from early in the 13th century. The chancel and nave appear to have been rebuilt early in the 15th century, though there is a window of earlier date in the chancel. The south porch belongs to the latter part of the century; the upper half of the west tower bears the date 1660.

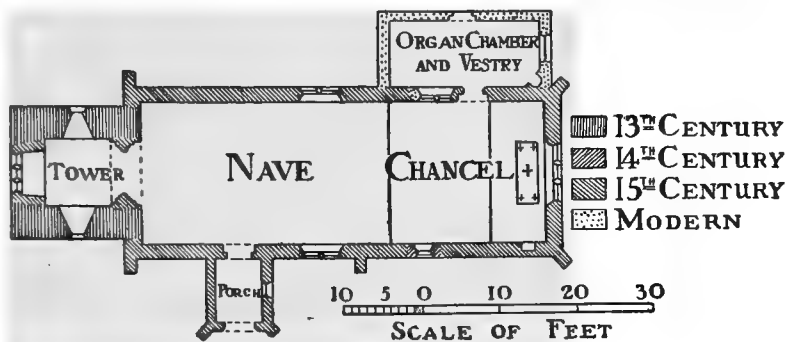

PLAN OF THROCKING CHURCH

The north vestry was added and the church re-roofed and restored in the 19th century.

The east window of the chancel is of three cinquefoiled lights with tracery under a four-centred arch; it has been restored in parts; it is of 15th-century date. In the north wall is a doorway of the same date, now opening into the modern vestry and organ chamber. The arch is four-centred and it and the jamb are splayed; on the vestry side is a moulded label. Adjoining the doorway is a modern stone traceried opening to the organ chamber. In the south wall is a single narrow light, apparently a 14th-century window reset; the pointed head is blocked and 15th-century tracery has been inserted beneath it. At the east end of the wall is a 15th-century piscina with a four-centred moulded and cusped arch under a square head and moulded label; it contains a stone credence shelf. The sill is modern. There is no chancel arch, a single step being the only division between chancel and nave.

⁷¹ Cussans, *Hist. of Herts. Edwinstree Hund.* 109.

⁷² Clutterbuck, *op. cit.* iii, 463.

⁷³ *East Herts. Arch. Soc. Trans.* iii, 154.

⁷⁴ Cussans, *Hist. of Herts. Edwinstree Hund.* 109.

⁷⁵ Dugdale, *Mon.* vi, 153; see above.

⁷⁶ Assize R. 325, m. 30 d.

⁷⁷ *V.C.H. Herts.* i, 305.

⁷⁸ *Ibid.*

⁷⁹ *Ibid.*

⁸⁰ *Plac. de Quo Warr.* (Rec. Com.), 290.

⁸¹ Feet of F. Herts. 2 Hen. III, no. 2.

⁸² De Banco R. 273, m. 75 d.

⁸³ *V.C.H. Herts.* i, 321b.

⁸⁴ *Ibid.*

⁸⁵ *Ibid.* 310b.

⁸⁶ *Ibid.*

A HISTORY OF HERTFORDSHIRE

The nave has a north and a south window, each of two lights with traceried heads under four-centred arches. They are of 15th-century date, but have been restored. The south doorway is of the same date; it has chamfered jambs and four-centred arch with moulded label. The south porch dates from the second half of the 15th century; it has a single pointed light on the east side only. The arch and jambs are splayed, but have no rebate for glass. The entrance has a four-centred moulded arch, the mouldings dying on splayed jambs. The head is square with a moulded label and in the spandrels are blank shields.

The tower arch has chamfered jambs and moulded bases of 15th-century date and a four-centred moulded arch and moulded capitals of 1660. In the lower stage of the tower, in the north and south walls, are narrow lancet windows widely splayed within; they are of 13th-century date. The west window is of three lights with trefoiled heads under a four-centred arch; it is of 15th-century date, but has been restored. The upper part of the tower is of red brick; a heavy brick string-course separates the upper and lower portions. At the south-west angle is an octagonal turret on an ogee-shaped corbel. The belfry windows are single lights with round arched heads. That on the east face now shows inside the church; in a panel on the south side is the date 1660. The parapet is plain, but at each angle is the lower part of a former pinnacle.

The roofs are modern, but a few carved figures of winged angels holding books, probably of 17th-century date, have been refixed under the trusses.

The font is of clunch with octagonal bowl and stem, the sides of which are panelled and cusped; the base is of cement. The font is of 15th-century date.

On the south wall of the nave, beneath the white-wash, are visible three crosses paty, within circles, about 9 in. in diameter, painted red. They vary in height from the floor from 4 ft. to 5 ft. 6 in.

Nearly all the seating is of 17th-century date with heavy moulded rails and panelled ends. In the chancel is a poppy-head, probably of the same date. It shows a man holding another man by the leg, while a third is balanced upside down on the first man's head; a large bird completes the group.

On the chancel floor is a large slab with inscription to Sir Thomas Soame, kt., 1670.

There is one bell by C. & G. Mears, 1855.

The communion plate consists of cup, 1606, cover paten without date or inscription and a modern flagon.

The registers previous to 1812 are as follows: (i) baptisms 1612 to 1812, burials 1616 to 1809, marriages 1612 to 1753; (ii) marriages 1754 to 1810.

The earliest reference to the *ADVOWSON* advowson of Throcking occurs at the beginning of the 13th century, when Richard de Vabadun released to Roger Fitz Brian, lord of the manor of Throcking, all right in a half of the advowson in exchange for an acre of land in Throcking.⁸⁷ From this date the advowson descended with the manor⁸⁸ (q.v.) until on the death of John Ray in 1840 it was sold to the Rev. William Adams,⁸⁹ who presented himself⁹⁰ and held the living until his death in 1878. It was then acquired by the Rev. Charles Wigan Harvey, who died in 1911. It is now held by the Rev. A. W. B. Higgens.

There do not appear to be any endowed charities in this parish.

WYDDIAL

Widihale (xi cent.); Withiale (xii cent.); Wide-wale (xiv cent.); Wydeale, Widyale (xv cent.); Wythyall, Whetteall, Widdyall (xvi cent.); Wyddwyall (xix cent.).

The parish of Wyddial contains 1,542 acres. It consists chiefly of arable land, only about one-sixth of the parish being permanent grass.¹ There is little woodland and what there is lies chiefly in the north of the parish, where College Wood in Wyddial adjoins the larger Capon Wood in Buckland. The soil is heavy on a subsoil of clay. The chief crops are wheat and barley. The parish lies for the most part about 400 ft. above ordnance datum, reaching a height of 441 ft. in the extreme north-west. In the north-east and south-west the land falls in the valleys of the Quin and Rib, which flow through the parish. In the south of the parish the boundaries between Wyddial and Layston are much intermixed.

Wyddial lies between two important roads, Ermine Street² forming its western boundary and the main road to Cambridge its short eastern boundary. The village, which is very small, lies on the high ground in the centre of the parish. The church stands to the north-west, close to Wyddial Hall. This house was burnt down in 1733 and rebuilt of brick plastered.

The 16th-century cellars still remain; they are built of thin brick. In the walls are several niches with triangular brick heads similar to those in Wymondley Bury and other old houses in the county. Some early 17th-century panelling remains in the house.

The school, which was built about 1864, is on the same side of the road, further south. The greater part of the population of Wyddial is at Buntingford, which lies partly within the parish.

Corney Bury stands on the east side of the main road about a mile north of Buntingford. It is a 17th-century building with 18th-century additions. Remains of a moat exist on the south-east side. The building is E-shaped, with the wings projecting to the north-west; it is of two stories with attics. The walls are of brick and the roofs partly tiled and partly slated. The north-west end of each wing has a curvilinear gable and there is another in the centre of the main block. The central porch is of early 18th-century date with Ionic columns and pediment. The windows are plain. Two lead rain-water heads bear the initials and date 'C.C. 1681.' The initials are for Charles Crouch, who owned the property at that date.

At Cave Gate there is a shaft which is said to be a denehole.

⁸⁷ Feet of F. Herts. 2 Hen. III, no. 2.

⁸⁸ See above.

⁸⁹ Cussans, *Hist. of Herts. Edwinstree*

Hund. 114.

⁹⁰ *Ibid.*

¹ Statistics from Bd. of Agric. (1905).

² There is a reference to Ermine Street

as a boundary of a tenement in Wyddial in 1438 (Anct. D. [P.R.O.], A 5208).



THROCKING CHURCH FROM THE SOUTH-EAST

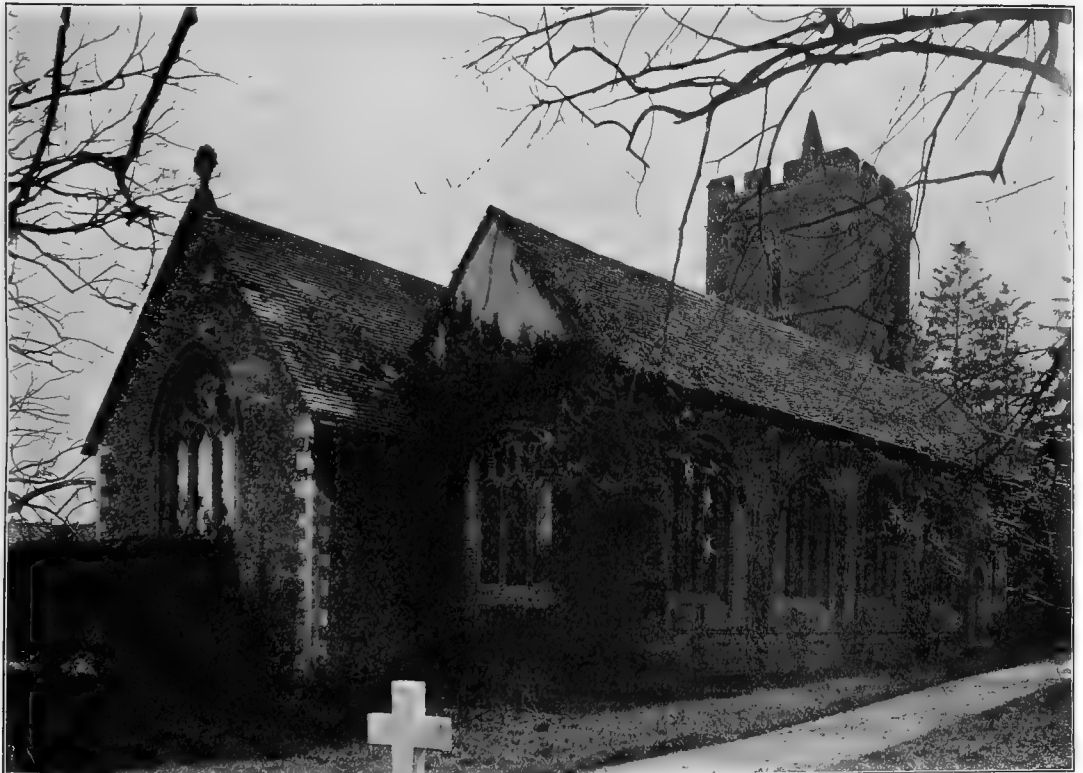

WYDDIAL CHURCH FROM THE NORTH-EAST

Before the Conquest Wyddial was *MANORS* divided among nine sokemen.³ Of these, Sired, a man of Earl Harold, held a manor there, and Alward, a man of Earl Algar, held another.⁴ The remainder of Wyddial was held by seven sokemen of King Edward, who found for the sheriff yearly 9d. or the carrying service of 2½ loads (*averas*).⁵ By 1086 Hardwin de Scales had obtained all these holdings, which together formed the manor of *WYDDIAL*.⁶ The manor was always held in chief.⁷

On the death of Hardwin de Scales his lands were divided between his two sons Richard and Hugh.⁸ Hugh obtained his manor of Wyddial⁹ and from him it descended to his son Henry de Scales.¹⁰ Henry was succeeded by his son Hugh¹¹; in 1195 Hugh's claim to Wyddial and various other lands was disputed by William de Scales, the grandson of Hardwin's son Richard mentioned above.¹² The case was adjourned in 1199 for so long as Henry son of Hugh should be in the service of the king beyond the sea.¹³ But later it was adjudged that Richard was not seised of the lands which Hugh held at the death of Henry II and judgement was given in favour of Hugh.¹⁴ On Hugh's death Wyddial descended to his son Henry, who settled it on his wife Maud before starting on a pilgrimage to Jerusalem. In his absence Maud was troubled in her possession by certain Jews, who endeavoured to obtain payment of her husband's debts out of the manor of Wyddial.¹⁵ Henry died abroad and as he left no issue his lands passed to his brother Geoffrey, who did homage for them in 1221.¹⁶ Maud, however, held Wyddial in dower until her death.¹⁷ It then reverted to Geoffrey de Scales and he in 1257 leased it for twelve years to the queen.¹⁸ The following year, at her instance, Henry III granted to Geoffrey de Scales that his son Geoffrey should perform the services due from his lands, as Geoffrey was at this time too old to perform them. In consideration of this Geoffrey granted his son his lands in Reed and Wyddial.¹⁹ The queen also conveyed to Geoffrey de Scales the younger and Eleanor his wife all rights in her lease of the manor.²⁰ In 1260 Geoffrey de Scales received a grant of free warren in his demesne lands of Wyddial and elsewhere.²¹ Geoffrey the younger died before 1267 and the custody of his son Thomas, a minor, was granted to his mother Eleanor, the tenants of his lands being allowed quittance of suit at the hundred and county court during the minority of the heir.²² Eleanor de Scales held in custody for her son²³ until

1283, when Thomas came of age,²⁴ and the following year his mother and her husband Robert Angot quit-claimed his lands to him.²⁵ They received a grant of Wyddial, however, for the term of their lives.²⁶ It reverted to Thomas de Scales before March 1304-5, probably on the death of Eleanor, for Thomas de Scales then granted £10 rent out of another of his manors to Robert Angot.²⁷ Thomas de Scales died seised in 1341.²⁸ The manor then included four customary tenants who were bound to reap 12 acres in the autumn when their labour was worth 3s. From the Feast of St. Michael to the beginning of August their labour was worth ½d. a day.²⁹ Thomas de Scales was succeeded by his son Thomas,³⁰ who in 1355 settled the manor on his son Thomas and Katherine his wife with remainder to his son John.³¹ Thomas died before his father, and on the latter's death in 1364 Wyddial descended to his grandson John son of Thomas.³² He held the manor until 1388, when he died and was succeeded by his son Thomas.³³ Wyddial was held in dower by his widow Margery, who took as her second husband Sir John Heveningham, kt.³⁴ The manor reverted to Thomas de Scales before 1428³⁵ and he held it until his death in February 1442-3.³⁶ His son John inherited it,³⁷ and at his death in 1467³⁸ the male line of the Scales family ended. His lands were divided between his three daughters and Wyddial descended to the youngest of these, Anne the wife of John Harcourt.³⁹

On the death of John Harcourt Anne married as her second husband Giles Wellisbourne, who died before January 1493-4, when she was again a widow. By her second marriage she had one daughter Margery, her heir, for whom she arranged a marriage with Humphrey Wellisbourne, a relation of her husband, who had helped her in settling her debts. By the marriage settlement she gave the manors of Wyddial and Reed to Humphrey and Margery, reserving for herself only an annual payment of 20 marks if she made her home with them or 40 if she lived elsewhere. Owing to a contract of marriage said to have been arranged between Margery and a certain John Rushton, Anne decreed by the settlement that if Rushton prevented the marriage of Margery and Humphrey, Humphrey should hold Wyddial for life, and that if Margery married Rushton, at Humphrey's death Wyddial should revert to the other heirs of Sir John Chalers or Scales, kt. This appears to have put an end to Rushton's claims, for the marriage between Margery and Humphrey took place, and on Anne's death in March 1493-4 they inherited the

³ *V.C.H. Herts.* i, 340a.

⁴ *Ibid.*

⁵ *Ibid.*

⁶ *Ibid.*

⁷ See Assize R. 323; *Cal. Inq. p.m.* 1-19 *Edw. I*, 309; *Chan. Inq. a.q.d.* file 52, no. 12; 6 *Ric. II*, no. 31; 11 *Ric. II*, no. 15; *Cal. Inq. p.m. Hen. VII*, 427. Part of the manor of Wyddial extended into Anstey (where Hardwin held land in 1086) and was held of the manor of Anstey. See *Chan. Inq. p.m.* 13 *Edw. II*, no. 75; *Cal. Close*, 1323-7, p. 273; also above, p. 14.

⁸ *Abbrev. Plac. (Rec. Com.)*, 99; see Dugdale, *Mon.* v, 3. Hugh is here called the son of Richard, but apparently without any evidence, for the reference given is to Dugdale's *Baronage*, where there is no mention of Richard.

⁹ See Dugdale, *Mon.* v, 3.

¹⁰ *Ibid.*

¹¹ *Ibid.*

¹² *Abbrev. Plac. (Rec. Com.)*, 99; *Rot. Cur. Reg. (Rec. Com.)*, ii, 199.

¹³ *Rot. Cur. Reg. (Rec. Com.)*, i, 410.

¹⁴ *Abbrev. Plac. (Rec. Com.)*, 99.

¹⁵ *Close*, 4 *Hen. III*, m. 11.

¹⁶ *Excerpta e Rot. Fin. (Rec. Com.)*, i, 69.

¹⁷ *Close*, 4 *Hen. III*, m. 11; Feet of *F. Div. Co.* 12 *Hen. III*, no. 15.

¹⁸ *Cal. Pat.* 1247-58, p. 549.

¹⁹ *Ibid.* p. 626.

²⁰ *Cal. Inq. p.m.* 1-19 *Edw. I*, 309.

²¹ *Cal. Pat.* 1258-66, p. 117.

²² *Close*, 51 *Hen. III*, m. 6.

²³ Assize R. 323, m. 41; *Hund. R. (Rec. Com.)*, i, 188.

²⁴ *Cal. Inq. p.m.* 1-19 *Edw. I*, 309.

²⁵ *Abbrev. Plac. (Rec. Com.)*, 206; *Coram Rege R.* 88, m. 1 (*Hil.* 13 *Edw. I*). See Reed in *Osdey Hundred*.

²⁶ Assize R. 325.

²⁷ *Inq. a.q.d.* file 52, no. 12.

²⁸ *Chan. Inq. p.m. Edw. III*, file 64, no. 20.

²⁹ *Ibid.*

³⁰ *Ibid.*

³¹ *Cal. Pat.* 1354-8, p. 301; Feet of *F. Herts.* 29 *Edw. III*, no. 446.

³² *Chan. Inq. p.m.* 6 *Ric. II*, no. 31.

³³ *Ibid.* 11 *Ric. II*, no. 15.

³⁴ *Ibid.* 12 *Ric. II*, no. 104.

³⁵ *Feud. Aids*, ii, 446.

³⁶ *Chan. Inq. p.m.* 21 *Hen. VI*, no. 20.

³⁷ *Ibid.*

³⁸ *Ibid.* 7 *Edw. IV*, no. 28.

³⁹ *Ibid.* See *Cal. Inq. p.m. Hen. VII*, 427.

A HISTORY OF HERTFORDSHIRE

manor.⁴⁰ Humphrey died in 1516 and Margery, in exchange for other lands left her by his will, settled Wyddial on their eldest son Arthur Wellisbourne in tail-male.⁴¹ She afterwards married Thomas Cheyne. In 1522 she quitclaimed Wyddial to Robert Dormer,⁴² to whom Arthur Wellisbourne sold his interest in the manor.⁴³

In 1528 Robert Dormer and Joan his wife conveyed the manor of Wyddial to George Canon and John Gill.⁴⁴ George Canon built the chapel of St. George in the parish church of Wyddial⁴⁵ and there he willed he should be buried, providing for a priest, four clerks and four children to say masses for him for twenty years.⁴⁶ He had one daughter and heir Margaret, who married John Gill,⁴⁷ and on his death in 1534⁴⁸ the manor became vested in John and Margaret.⁴⁹ Their son George inherited the manor on the death of John in March 1545-6.⁵⁰ He held it until his death in 1568, when he was succeeded by his son John.⁵¹ In 1600 the manor descended to John's son and heir George Gill,⁵² who was knighted at Whitehall in 1603.⁵³ In 1619 he died and his son John Gill inherited Wyddial.⁵⁴ He sold it in 1627 to John Goulston.⁵⁵

On the death of John Goulston in 1643 the manor descended to his son Richard,⁵⁶ who during his tenure of the manor made a park round Wyddial Hall.⁵⁷ In 1686 Richard Goulston died and was succeeded by his son James,⁵⁸ who died in 1704, when Wyddial descended to his son Richard.⁵⁹ Richard died in 1731.⁶⁰ His son Francis inherited the manor⁶¹ and sold it in 1772 to Stephen Comyn, barrister-at-law and bencher of the Inner Temple.⁶² Stephen Comyn died the following year and the manor of Wyddial passed to his two sons Stephen and Robert, who sold it shortly afterwards to Brabazon Ellis,⁶³ who came of an ancient Welsh family.⁶⁴ He died in 1780 and his son John Thomas Ellis, M.P., who married Mary Anne, the only daughter of John Heaton of Bedford in Havering atte Bower, co. Essex, succeeded him.⁶⁵ At his death at Milan in 1836⁶⁶ the manor passed

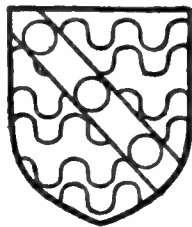

GOULSTON of Wyddial *Argent three bars wavy gules with a bend sable over all and three roundels argent upon it.*

to his son Charles Arthur Hill Heaton-Ellis,⁶⁷ who died in 1865.⁶⁸ His widow held it for life, and at her death in 1880 it descended to her grandson Lieut.-Col. Charles Henry Brabazon Heaton-Ellis, son of Edward Henry Brabazon, second son of C. A. H. Heaton-Ellis,⁶⁹ who is the present lord of the manor.⁷⁰

The manor of CORNEYBURY (Corney, xi cent.; Cornheie, Corneia, xii cent.; Courneybury, xvi cent.) was formed from two small holdings which in the reign of Edward the Confessor were held by Alward, a man of Harold, and Gode, a man of King Edward, the former having 1 virgate and the latter 3.⁷¹ By 1086 these two estates had become united in the possession of Count Eustace of Boulogne and the whole was held of him by his tenant Robert. The overlordship remained with the honour of Boulogne,⁷² which came to the Crown through the marriage of Maud daughter of Count Eustace III of Boulogne with King Stephen and was resumed by Henry II after the death of Queen Maud's two sons.⁷³

In the early part of the 12th century the manor was held by Hugh Triket, who had inherited it from his father,⁷⁴ who was possibly the Robert of 1086. Hugh granted all his lands in Corneybury to the church of Holy Trinity, London.⁷⁵ In 1212 Simon Triket had rights of overlordship in Corneybury.⁷⁶

The canons of Holy Trinity held the manor⁷⁷ until the dissolution of their priory. In 1253 Henry III granted them free warren in all their demesne lands of Hertfordshire and a market to be held every Tuesday in their manor of Corneybury and a fair there every year on the vigil and feast of St. Bartholomew and the six days following.⁷⁸ The bridge over the Rib between Corneybury and Throcking was broken in 1287 and the Prior of Holy Trinity was ordered to repair it by his men in Throcking and Corneybury.⁷⁹ The priory of Holy Trinity was dissolved in 1531⁸⁰ and in 1534 its site and lands were granted by Henry VIII to Sir Thomas Audley.⁸¹ In 1538 Sir Thomas settled the manor of Corneybury on himself and his wife Elizabeth in tail.⁸² He was created Lord Audley de Walden the same year.⁸³ At his death in 1544 he left two daughters and co-heirs, Mary and Margaret.⁸⁴ The wardship and marriage of Margaret were granted to Sir Anthony Denny, together with an annuity of

⁴⁰ *Cal. Inq. p.m. Hen. VII.*, 427.

⁴¹ *Close*, 7 Hen. VIII, no. 41.

⁴² *Ibid.* 14 Hen. VIII, no. 24.

⁴³ *Ibid.* no. 25.

⁴⁴ Feet of F. Herts. East. 20 Hen. VIII.

⁴⁵ Chauncy, *Hist. Antiq. of Herts.* 112.

⁴⁶ P.C.C. Will, 18 Hogan.

⁴⁷ *Coll. Test. g. et Gen.* viii, 275.

⁴⁸ *Ibid.*; Berry, *Herts. Gen.* 56.

⁴⁹ *L. and P. Hen. VIII*, xii (1), g. 795 (11).

⁵⁰ Chan. Inq. p.m. (Ser. 2), lxxxvi, 97.

⁵¹ *Ibid.* cli, 58. ⁵² *Ibid.* cclxv, 77.

⁵³ Shaw, *Knights of England*, ii, 122.

⁵⁴ Chan. Inq. p.m. (Ser. 2), cccvii, 95.

⁵⁵ *Recov. R. East.* 3 Chas. I, rot. 62;

Com. Pleas D. Enr. Mich. 3 Chas. I, m. -; Trin. 7 Chas. I, m. 1.

⁵⁶ Chan. Inq. p.m. (Ser. 2), dccxliii, 16.

⁵⁷ Chauncy, loc. cit.

⁵⁸ *Ibid.*; *Recov. R. Trin.* 12 Will III, rot. 88.

⁵⁹ Clutterbuck, op. cit. iii, 471; *Recov. R. Trin.* 8 Geo. I, rot. 71.

⁶⁰ Clutterbuck, loc. cit.

⁶¹ *Ibid.*; *Recov. R. Trin.* 28 Geo. II, rot. 205.

⁶² Cussans, *Hist. of Herts. Edwinstree Hund.* 120.

⁶³ Clutterbuck, loc. cit.

⁶⁴ Burke, *Landed Gentry* (1906), s.v. Heaton-Ellis of Wyddial Hall. Brabazon Ellis was son of Dr. Ellis, author of *Ellis on Divine Things*. ⁶⁵ *Ibid.*

⁶⁶ Cussans, loc. cit.; Burke, *Landed Gentry* (1906).

⁶⁷ cf. *Recov. R. Mich.* 8 Geo. IV, rot. 220.

⁶⁸ Burke, *Landed Gentry* (1906).

⁶⁹ The eldest son Charles John Heaton-Ellis died before Delhi in 1857.

⁷⁰ Information from the Rev. F. R. Broughton.

⁷¹ *V.C.H. Herts.* i, 321a.

⁷² *Liber Niger Scacc.* (ed. T. Hearne), i, 389; *Red Bk. of Exch.* (Rolls Ser.), ii, 581; *Testa de Nevill* (Rec. Com.), 274; *Cal. Close*, 1343-6, p. 516.

⁷³ Round, *Studies in Peerage and Family History*, 172.

⁷⁴ Dugdale, *Mon.* vi, 152. ⁷⁵ *Ibid.*

⁷⁶ *Red Bk. of Exch.* (Rolls Ser.), ii, 581; *Liber Niger Scacc.* (ed. Hearne), i, 389. For descent of this family see manor of Berkesden in Aspenden.

⁷⁷ *Anct. Chart.* (Pipe R. Soc.), 104; Pipe R. 6 John, m. 3 d.; 12 John, m. 18; *Red Bk. of Exch.* (Rolls Ser.), ii, 581; *Testa de Nevill* (Rec. Com.), 274; *Feud. Aids*, ii, 432, 446, 453; *Abbrev. Plac.* (Rec. Com.), 344; *Cal. Close*, 1343-6, p. 510; Ct. R. (Gen. Ser.), portf. 177, no. 29.

⁷⁸ *Cal. Chart. R.* 1226-57, p. 427.

⁷⁹ *Assize R.* 325, m. 30 d.

⁸⁰ Dugdale, *Mon.* vi, 150.

⁸¹ *L. and P. Hen. VIII*, vii, g. 587 (10), 1601 (35).

⁸² *Ibid.* xiii (2), 491 (6).

⁸³ G.E.C. *Complete Peerage*, s.v. Audley of Walden.

⁸⁴ Chan. Inq. p.m. (Ser. 2), lxxxvi, 100.



WYDDIAL CHURCH : THE CHANCEL ARCH AND NORTH ARCADE



WYDDIAL CHURCH : THE NORTH AISLE LOOKING EAST

£50 from various manors of her inheritance including Corneybury.⁸⁵ Margaret married first Lord Henry Dudley, son of the Duke of Northumberland,⁸⁶ who was killed at St. Quintins in 1557,⁸⁷ and secondly Thomas Duke of Norfolk.⁸⁸ She died seised of Corneybury in January 1563-4.⁸⁹ Her husband survived her and held the manor until January 1571-2, when he was attainted for high treason, and it then passed to her son Thomas Lord Howard.⁹⁰ In 1583 he sold it to John Crouch.⁹¹ John Crouch died in February 1605-6 and left Corneybury to his second son Thomas Crouch,⁹² who held it until his death in 1616.⁹³ The manor then passed to his son John⁹⁴ and at his death in 1649 to his third son Charles.⁹⁵ Thomas Crouch, second son and heir of Charles,⁹⁶ raised a company of soldiers at his own expense in 1688 to support the king in Ireland. After an unsuccessful campaign, in which he lost most of his men,⁹⁷ he returned to England and in 1690 sold the manor of Corneybury to Ralph Hawkins, brewer, of London.⁹⁸ Ralph died in 1696 and the manor descended to his son John Hawkins.⁹⁹ Thomas Hawkins, son of John,¹⁰⁰ died in 1742 and by his will left Corneybury to his niece Catherine, the wife of William Woolball of Walthamstow, co. Essex, with remainder to their issue.¹ Their daughter and heir Catherine married Sir Hanson Berney of Kirby Bedon, co. Norfolk, bart.,² and in 1790, after her husband's death,³ joined with her son Sir John Berney in selling the manor of Corneybury to William Butt.⁴ He held it until his death in 1806, when it descended to his son William Butt,⁵ who in 1841 was succeeded by a son of the same name.⁶ The estate has lately been sold, after the death of the latter, by his sons.

The church of *ST. GILES* stands on *CHURCH* high ground about $1\frac{1}{2}$ miles north-east of Buntingford and consists of chancel 23 ft. by 15 ft., north chapel 18 ft. by 12 ft., nave 39 ft. by 19 ft., north aisle 10 ft. 6 in. wide, west tower 10 ft. by 9 ft. 6 in. and south porch; all the dimensions are internal. The walls generally are of flint rubble; those of the north chapel and aisle are of brick; the roofs are tiled.

Owing to the extensive restoration of the church it is difficult to assign a date for its erection, but it is probable that the chancel, nave and west tower were all built during the 15th century. The north chapel and aisle were built by George Canon in 1532, as appears from a brass inscription from his

tomb now preserved in the rectory. In 1865 the chancel, nave and aisle were practically rebuilt and a south porch was added.

The three-light window in the east wall of the chancel and the two windows in the south wall are modern. In the north wall is the brick archway to the north chapel. The arch is pointed and has two hollow-chamfered orders; the responds are semi-octagonal with roughly moulded brick capitals. The chancel arch is of 15th-century date and is of two moulded orders, the outer order continuous, the inner resting on engaged circular shafts with moulded capitals and bases; it has been repaired. The east window of the north chapel is of three cinquefoiled lights with tracery under a four-centred arch; it is all of brick with moulded arch and label. The two windows in the north wall are each of three lights, with moulded brick jambs and arches. A screen marks the division between the chapel and the north aisle. The chapel was dedicated to St. George⁷; it is built of thin bricks.

On the north side of the nave is an arcade of three bays of 1532; all the work is of brick, which has been artificially coloured red and tuck-pointed with black lines. The pointed arches are of three chamfered orders, the centre one hollow-chamfered. The piers are formed of four semi-octagonal shafts separated by hollow chamfers; the moulded capitals are crude in execution, the bases are of cement. The three windows and the doorway in the south wall are all modern; the south porch is also modern. In the north-east angle of the nave is the turret containing the rood stair, the doorways to which are blocked. The north aisle has two windows in the north wall, each of three lights with moulded jambs and arch. Another window near the west end is of 15th-century date, reset; it is of stone with two cinquefoiled lights with a square head and moulded brick label. The west window of the aisle is also of 15th-century date, reset; it is of stone with two cinquefoiled lights under a traceried head. This window is not central with the aisle, and externally, between the window and the west tower, is an apparently solid mass of brickwork about 9 ft. wide and projecting about 20 in.; it has splayed sides and is carried up to the wall-head and finished with a tiled roof. It has no connexion with the tower and is too wide for a turret stair; as it is directly behind the west impost of the nave arcade, it acts as a buttress and may have been intended as such. All the roofs are modern.

The west tower is of three stages with short leaded spire and embattled parapet. The tower arch is of two chamfered orders, the outer one continuous, the inner resting on semi-octagonal shafts with moulded capitals and bases; it is of 15th-century date. The west window is of two cinquefoiled lights with quatrefoil in the head; it has been repaired with cement.

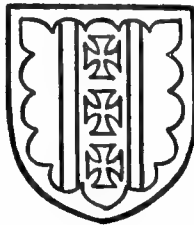

CROUCH of Corneybury. *Argent three crosses formy between two pales within a border engrailed sable.*

⁸⁵ *L. and P. Hen. VIII*, xx (1), g. 465 (88).

⁸⁶ G.E.C. loc. cit.

⁸⁷ *Ibid.*

⁸⁸ *Ibid.*

⁸⁹ *Chan. Inq. p.m.* (Ser. 2), clxii, 167.

⁹⁰ *Ibid.* and also clxi, 79.

⁹¹ Feet of F. Herts. East. 25 Eliz.

⁹² *Chan. Inq. p.m.* (Ser. 2), ccxcv, 86.

⁹³ *Ibid.* ccclxi, 147.

⁹⁴ *Ibid.*

⁹⁵ Chauncy, *Hist. Antiq. of Herts.* 127.

⁹⁶ Close, 2 Will. and Mary, pt. vii, no. 10.

⁹⁷ Chauncy, *Hist. Antiq. of Herts.* 130.

⁹⁸ Close, 2 Will. and Mary, pt. vii, no. 10.

⁹⁹ Chauncy, loc. cit.

¹⁰⁰ Clutterbuck, *Hist. and Antiq. of Herts.* iii, 427.

¹ P.C.C. Will, 354 Trenley. Mary

wife of Charles Walmsley made a claim

on the manor as the executrix of Japhet

Crook, late of the parish of St. Margaret's,

co. Herts., but the Court of Delegates

gave judgement against her, and in 1740 she quitclaimed all right in the manor.

See Feet of F. Herts. Hil. 14 Geo. II.

² Clutterbuck, loc. cit.; G.E.C. *Complete Baronage*, i, 143.

³ G.E.C. loc. cit.

⁴ Clutterbuck, loc. cit.

⁵ *Ibid.*; Feet of F. Herts. East. 51

Geo. III.

⁶ Cussans, loc. cit.

⁷ Will of George Canon, 20 Oct. 1534

(P.C.C. Wills, F 18 Hogan).

A HISTORY OF HERTFORDSHIRE

The north, south and west belfry windows are each of two cusped lights, much defaced and repaired with brick. On the east side is a single square-headed light.

The font is modern. The oak screens between the north chapel and the chancel and north aisle and under the tower arch are of 17th-century date; the lower parts are panelled, the upper panels being carved and pierced. The upper part consists of a series of round-headed openings separated by pilasters; over each opening is a semicircular open panel with moulded radiating bars; the top is finished with moulded architrave, swelled frieze and moulded cornice. In the aisle are three inclosed pews with carved and panelled sides to match the lower part of the screens; they are of the same date. In the nave are some old reeded panels incorporated with modern seating. The communion table is of late 17th-century date, with turned and moulded legs. In two of the north aisle windows are panels of late 16th-century glass, probably Flemish; the scenes painted include Peter cutting off the servant's ear, Christ before Pilate, Christ being scourged and bearing the Cross, and some others.

On the north wall of the nave is a board with painted inscription to Margery wife of Anthony Disney, 1621. On the north wall of the chancel is a brass with half-length figure of a lady, with arms and inscription to Dame Margaret only daughter of Sir Thomas Nevill, widow of Sir Robert Southwell, kt., Master of the Rolls, and wife of William Plumbe; she died in 1575. On the floor is a brass to John Gill, 1546, with the figures of a man and his wife, eight daughters, arms and inscription, and indent of sons; another to George Gill, 1568, partly hidden under the flooring, with inscription and arms; a third to John Gill, 1600, and Joan his wife, with inscription. On the south wall of the chapel is a monument of marble and alabaster, with twisted columns supporting a broken pediment, to Sir William Goulston,

1687; on the cornice are marble busts of Sir William and Frediswide, his wife. On the east wall is a tablet to Richard Goulston, 1686, with brass on floor beneath, on which is a punning Latin inscription. On the north wall is a tablet to Jane Goulston, 1630. On the floor is a brass to Helen daughter of John Goulston and wife of John Joscelyne, d. 1640; also a brass with the lower part only of a figure of a civilian, supposed to be that of George Canon, 1534, the founder of the chapel; the inscription is preserved at the rectory.

There are four bells: the first by J. Warner & Sons, 1866; the second inscribed 'Sancta Katerina Ora Pro Nobis,' probably of the 14th century; the third without inscription; the fourth by C. Graye, 1666.

The communion plate is modern. A chalice and paten of silver gilt were given in 1727 by Richard Goulston. They were melted down in the great fire at Wyddial Hall, a small part of the material which was recovered being converted into the chalice and paten (with date 1734) in use at the present day.

The registers previous to 1812 are as follows: (i) baptisms 1666 to 1812, burials 1669 to 1812, marriages 1666 to 1810; (ii) marriages 1756 to 1805.

There was a priest in Wyddial *ADVOWSON* in 1086.⁸ The advowson was originally attached to the manor, but early in the 12th century it was granted by Hugh de Scales, lord of the manor, to the priory of Lewes.⁹ It remained with this priory¹⁰ until 1537, when the prior surrendered it to the Crown.¹¹ In 1538 the site of the priory and many of its possessions, including the advowson of Wyddial, were granted by the king to Thomas Lord Cromwell.¹² On his attainder in 1540 the advowson again came into the king's hands and in 1544 was granted to John Gill, lord of the manor of Wyddial.¹³ From this date the advowson has descended with the manor¹⁴ (q.v.)

There do not appear to be any endowed charities in this parish.

⁸ *V.C.H. Herts.* i, 340a.

⁹ Dugdale, *Mon.* v, 3.

¹⁰ See list of patrons, Clutterbuck, (74).
Hist. of Herts. iii, 473.

¹¹ Feet of F. Herts. Mich. 29 Hen. VIII.

¹² *L. and P. Hen.* VIII, xiii (1), g. 384

¹³ *Ibid.* xix (1), g. 610 (27).

¹⁴ *Inst. Bks.* (P.R.O.)

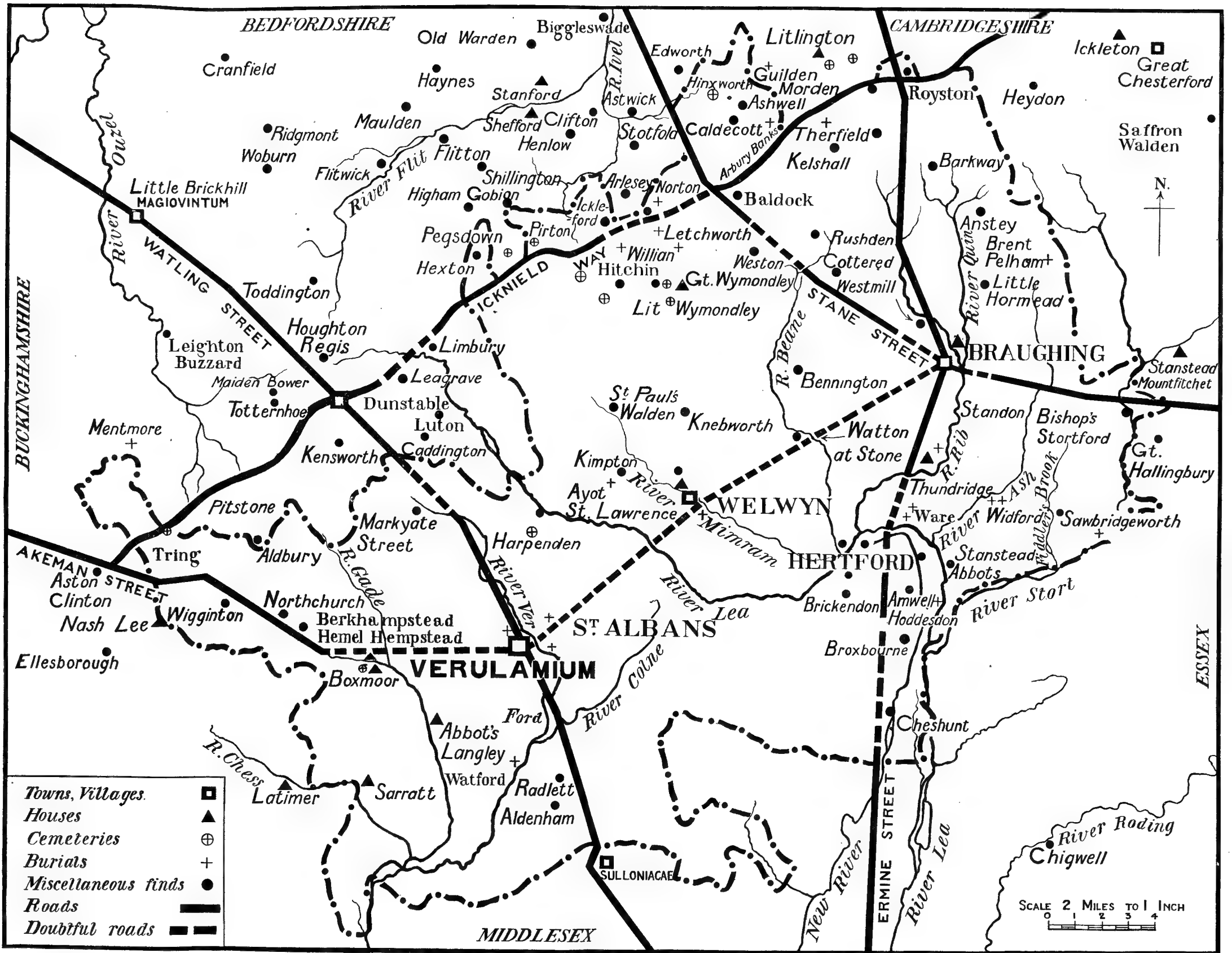

MAP SHOWING ROMANO-BRITISH REMAINS IN HERTFORDSHIRE



CELTIC AND ROMANO-BRITISH HERTFORDSHIRE

BEFORE the Roman occupation and indeed till long afterwards the south-eastern part of Hertfordshire, lying on the London clay, and a little to the north and west of the clay, was a part of a dense woodland which also covered Middlesex and the south-west of Essex.¹ Few Roman remains have been found in this district, and, except along the line of Ermine Street, it probably remained comparatively uninhabited till it was cleared and settled two or three centuries before the Norman Conquest.² The rest of the county is on chalk, which on the north-eastern side is covered with boulder clay and to the west, on the Chiltern Hills, by 'clay with flints.' Both these surface-soils, but particularly the former, are known for their fertility, and consequently these districts have long been famed as corn-growing lands. This may be the reason why they were selected for settlement by the Belgic tribes who overran the south-eastern quarter of Britain about B.C. 200 and are known to have been agriculturists.³ This people came from Gallia Belgica, which covered the northern part of Gaul, from Paris to the Rhine, and seem to have settled here by tribes. They continued an intimate intercourse with their kinsmen across the Channel and had a higher standard of civilization than the other inhabitants of this island. They were the first to introduce into Britain a coinage such as was in use in Belgic Gaul, and certain elegantly-shaped cordoned urns seem to be confined to the district settled by them. In general, they shared with the rest of Britain the Late Celtic art, principally in bronze, showing elaborate designs of the returning spiral of which that on the top of a sword scabbard lately found at Verulamium is a good example. The ornament on it is characteristically Late Celtic, possibly of the earlier part of the first century A.D.⁴

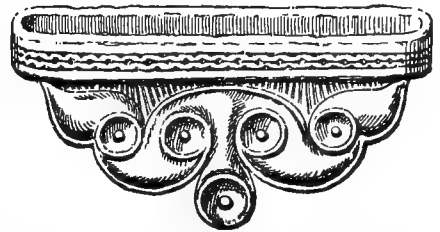

TOP OF LATE CELTIC SWORD SCABBARD
FROM VERULAMIUM

The tribe that inhabited the district now known as Hertfordshire, up to the Lea, was the Catuvellauni, miscalled by Ptolemy the Catyeuchlani.

¹ At the present day in driving along the Great North Road the scenery changes a little north of Welwyn from woodland to the south to open country to the north.

² No Roman remains are recorded as having been found in the area bounded approximately by Watling Street on the west, Sandridge to Digswell and the River Mimram to Hertingfordbury on the north and an imaginary line from Hertingfordbury southward to the county boundary.

³ The Trinovantes supplied Caesar with corn, and a wheat-car appears on many of the British coins.

⁴ *Proc. Soc. Antiq.* (1911-12), xxiv, 132.

A HISTORY OF HERTFORDSHIRE

Their territory probably included the present counties of Middlesex and Hertford and extended into Buckinghamshire, Oxfordshire, Bedfordshire and Northamptonshire. According to Ptolemy their chief towns were Urolanium or Verulamium (near St. Albans in Hertfordshire) and Salinae.⁶ Besides these towns they had in Hertfordshire settlements at Welwyn, Hitchin and Braughing, and it is probable that the county is richer in remains of this race than is generally supposed.

Caesar's first invasion in B.C. 55 did not affect the inland part of Britain, but the second in the following year had more far-reaching effects. The Belgic tribes in Britain, as was their custom, were constantly engaged in internecine warfare, but appreciating the seriousness of the Roman attack they determined to combine for the purpose of defence. The chief men of the tribes met and gave to Cassivellaunus, Prince of the Catuvellauni, the supreme command of the British forces.⁸ We know little of this prince. It has been suggested that he succeeded to the chief rule of the Belgic tribes in Britain by hereditary right from Divitiacus,⁷ King of the Suessiones, a tribe whose territory lay to the north-west of Paris. Caesar states that Britain, by which possibly he meant that portion occupied by the Belgic tribes and best known to the Gauls, was brought under the rule of this Divitiacus at a period before his time.⁹ The fact, however, mentioned by Caesar that Cassivellaunus was elected general seems to dispose of the suggestion that he succeeded by inheritance to that office. It is probable, however, that he was the most powerful king in Britain in his time. He had apparently waged war on his neighbours the Trinovantes, who inhabited what is now the county of Essex, and had slain their king¹⁰ Imanuentius. Mandubracius, son of Imanuentius, escaped to Gaul and invited Caesar's aid probably before the first invasion of Britain. He accompanied Caesar on his second invasion, when he evidently persuaded the Trinovantes to submit, and was probably the means of securing the submission of other tribes. In his second invasion Caesar landed near Sandwich in July, B.C. 54.¹⁰ The route he took and the place at which he crossed the Thames do not concern us with regard to Hertfordshire.¹¹ The Romans reached the Thames about a week after commencing their march, and the Britons, having failed in preventing the Roman army from crossing that river, seem to have lost heart.¹² Cassivellaunus seeing no prospect of success by a general engagement disbanded the greater part of his army, retaining only some 4,000 charioteers.¹³

The laconic language of Caesar gives us no clue as to his route north of the Thames. It was apparently along a recognized track, for he states that Cassivellaunus moved a little way *ex via* and hid himself in impenetrable woodland, so that with his intimate knowledge of the ground he might cut off foragers and harass the Roman army. It would seem probable that the

⁵ The site of Salinae is unknown. Its identification with Sandy in Bedfordshire is uncertain.

⁶ De Bello Gallico, v, 11.

⁷ Guest, *Origines Celticae*, 394; see also T. Rice Holmes, *Ancient Britain*, 299, 300.

⁸ De Bello Gallico, ii, 4.

⁹ Ibid. v, 11, 20. The provision by Caesar for the safety of Mandubracius and the Trinovantes from molestation by Cassivellaunus (ibid. 22) implies that war had been waged between the tribes.

¹⁰ Ibid. v, 20, 21; T. Rice Holmes, op. cit. 333.

¹¹ *V.C.H. Surr.* iv, 343; *Proc. Soc. Antiq.* xxiv, 137 et seq.

¹² De Bello Gallico, v, 18.

¹³ Ibid. 19.

CELTIC AND ROMANO-BRITISH HERTFORDSHIRE

track referred to followed the line of Watling Street, north-west of London, which would have as its objectives the lowest safe ford across the Thames and Verulamium. It passed through a district then and for long afterwards dense woodland,¹⁴ such as would have concealed the army of Cassivellaunus and would have been adapted to the tactics pursued by the British.

After beginning his march north of the Thames, Caesar received envoys from the Trinovantes, who submitted to him, giving hostages and a supply of corn.¹⁵ In return he sent them Mandubracius their prince and gave them protection from the Roman soldiers.¹⁶ The example of the Trinovantes was followed by five other tribes who sent envoys and surrendered. These negotiations must have occupied some days and would necessitate a halt. It was at this time and from these latter envoys that the exact position of the stronghold (*oppidum*) of Cassivellaunus was ascertained. Caesar writing in the third person states¹⁷ :—

He learnt from the envoys that the stronghold of Cassivellaunus, which was protected by woods and marshes, was not far off, and that a considerable number of men and of cattle had assembled in it. The Britons apply the name of stronghold to any woodland spot difficult of access and fortified with a rampart and trench to which they are in the habit of resorting in order to escape a hostile raid. Caesar marched to the spot indicated with his legions and found that the place was of great natural strength and well fortified; nevertheless he proceeded to assault it on two sides. The enemy stood their ground a short time, but could not sustain the onset of our infantry and fled precipitately from another part of the stronghold. A great quantity of cattle was found in the place, and many of the garrison were captured as they were trying to escape and killed.

The site of the stronghold of Cassivellaunus has long been a matter of dispute. Verulamium, London, Camulodunum or Colchester, Cassiobury Park, Pinner and Harrow have each been claimed for it.¹⁸ As regards the three last there seems to be no valid ground for a claim. Camulodunum was in the territory of the Trinovantes and could not therefore have been the stronghold of Cassivellaunus.¹⁹ The claim of London has been strongly urged,²⁰ but the evidence mainly lies in the supposed existence of a Late Celtic stronghold on Ludgate Hill of which no indications remain and of which there has been found no evidence of a rampart and ditch such as, according to Caesar, existed at the stronghold of Cassivellaunus. Professor Haverfield, the most recent authority on Roman London, states that 'either there was no pre-Roman London or it was a small and undeveloped settlement which may have been on the south bank of the Thames.'²¹ It is clear that London was of little importance before the Claudian invasion. No British coins were struck there and only one such coin is recorded as

¹⁴ In *Gesta Abbatum Mon. S. Albani* (Rolls Ser.), i, 43, reference is made to a lease of about 1066 of the manor of Aldenham 'ubi frequentius, propter sylvarum abundantiam, transeuntibus et Londoniam adeuntibus, imminabant pericula.' Watling Street passes through the parish of Aldenham and is the main thoroughfare to London. See also as to the clearing of this district by Abbot Leofstan (*ibid.* 39).

¹⁵ Some authorities state that on crossing the Thames Caesar marched towards the land of the Trinovantes (Essex), but he himself gives no hint of this, and if his goal was the stronghold of Cassivellaunus, which there can be little doubt was Verulam, it is highly improbable he would have gone so far out of his way.

¹⁶ *De Bello Gallico*, v, 20.

¹⁷ *Ibid.* 21. The translation is taken from T. Rice Holmes, *Caesar's Commentaries* (1908), 141.

¹⁸ The claims of all these sites have been dealt with by T. Rice Holmes (*Ancient Britain*, 701).

¹⁹ *Ibid.* 702.

²⁰ T. Lewin in *Arch.* xl, 65; Sir Lawrence Gomme, *Making of London*, 17-23, 36. There were pile dwellings at Finsbury and at the Fleet outside the site of Roman London, and possibly hut dwellings at Cheapside; Gomme, *op. cit.*

²¹ *Journ. of Roman Studies* (1911), 146.

A HISTORY OF HERTFORDSHIRE

having been found on the site.²³ Had London been the stronghold of Cassivellaunus, Caesar would not have omitted from his description of the site the all-important fact that it stood on the Thames.

So far as the evidence at present goes the only place that was undoubtedly a Late Celtic stronghold fulfilling the requirements of Caesar's description, is Verulamium, near St. Albans. It was surrounded by woodland on its east, west and south sides, which then would be difficult of access, it had a marsh on its north side and was fortified by a formidable earthen rampart and ditch. Besides, we know that it was the stronghold of the immediate successor of Cassivellaunus, and numerous coins and other objects of the Late Celtic period have been discovered on its site (Pl. i).²³

Caesar must have arrived at this British stronghold about the beginning of August. Cassivellaunus was at that time away planning an attack on the Roman naval camp on the Kentish coast, but the attack failed, and shortly afterwards being deserted by several of the confederated tribes he sued for peace.²⁴ Caesar was glad to bring to an end a somewhat inglorious and unprofitable campaign, and having arranged for hostages, tribute and the independence of his allies, the Trinovantes, he returned with his army to the coast. After some delay at the naval camp his fleet started for Gaul about the middle of September. Caesar's invasions of Britain must have been extremely costly and the results cannot have been commensurate with the outlay. It is true they put a stop to British interference in Gaul, but it is unlikely that the Romans obtained much booty, and it is more than doubtful if the tribute imposed upon the Britons was regularly paid. On the other hand the invasions had a lasting effect on the Britons themselves. They opened up the country to Roman commerce and admitted higher ideas of civilization.

Cassivellaunus continued to rule over the Catuvellauni with his seat of government probably at Verulamium, apparently leaving the Trinovantes under the rule of Mandubracius. He died about B.C. 47, and was succeeded by Tasciovanus, possibly his son, who continued to make Verulamium the seat of government. We know little of his reign, but it would seem that towards the close of it he acquired the dominion of the Trinovantes either by conquest, succession, or election. There seems to be some evidence that during his lifetime he appointed his son Cunobeline or Cymbelene to rule over this latter tribe with his seat of government at Camulodunum.²⁵ On the death of Tasciovanus about A.D. 5, Cunobeline continued to make the seat of his government at Camulodunum, owing to which Verulamium lost its position as chief town in Britain. He seems to have reassumed the sovereignty which Cassivellaunus held over the Belgic tribes in the south-east of Britain and the gradually increasing intercourse with the continent and Rome brought him considerable wealth and power.²⁶

²² The records of the discovery of objects in London are so scattered that it is difficult to speak positively as to what has been found, but it seems certain that very few objects of the Late Celtic period have been discovered actually on the site of Roman London.

²³ *V.C.H. Herts.* i, 238-42. Verulamium was of sufficient distance from the Thames to allow for the tactics of Cassivellaunus and the other occurrences as described by Caesar.

²⁴ *De Bello Gallico*, v, 22.

²⁵ Evans, *Coins of the Ancient Britons* (1864), 289.

²⁶ *Ibid.* The objects found with the burials at Welwyn in 1906 are of this period, and some of them must have been very costly importations from Italy. See also remarks as to the indications of wealth as shown by the late Celtic coinage, *infra*.



VERULAMIUM : LATE CELTIC BRONZE HELMET (*now in the Colchester Museum*)

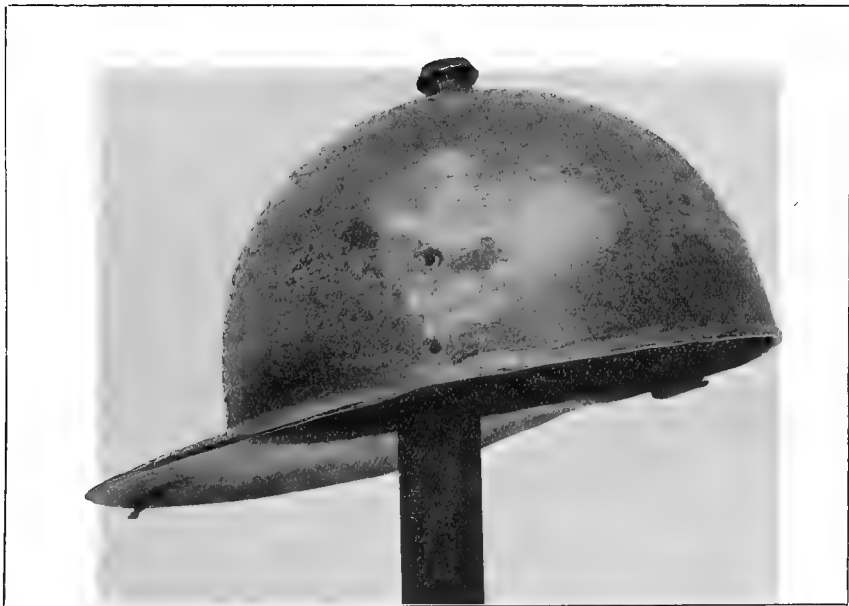

NORTHCHURCH : LATE CELTIC BRONZE HELMET FOUND AT NORTHCOTT HILL

CELTIC AND ROMANO-BRITISH HERTFORDSHIRE

A little before his death, which occurred about A.D. 41, dissensions arose among his sons Adminius, Togodumnus and Caratacus, and possibly a fourth, Bericus. The dissensions led to an insurrection²⁷ on account of which Adminius was banished by his father. He fled to the Emperor Caligula and persuaded him in A.D. 40 to start on an expedition to invade Britain.²⁸ The army got no farther than the sea shore opposite Britain, where, as the story goes, the mad Caligula drawing up his troops suddenly ordered them to gather shells as 'the spoils of the ocean,' and then retired.²⁹ The confusion in Britain continued after Cunobeline's death when Togodumnus and Caratacus either divided their father's dominion or ruled jointly.

In A.D. 43 the Emperor Claudius, at the instigation of Bericus, who had fled to Rome,³⁰ sent an army under Aulus Plautius to subjugate Britain. The Romans met with little opposition till they reached a river, probably the Medway, where Togodumnus and Caratacus vainly attempted to stop their progress. Similar tactics were tried at the Thames without result, but at one of these engagements Togodumnus was slain. There was then a pause in the campaign in order that Claudius might bring up reinforcements and take part in the conquest of Camulodunum or Colchester. The defeat of Caratacus by Claudius and the capture of Camulodunum do not belong to the history of this county, but they marked the subjugation of all south-eastern Britain including the lands of the Catuvellauni and Trinovantes.

The Romans having thus established themselves, the army was formed into three divisions, the Second Legion going south-west to Somerset and Devon, the Fourteenth and Twentieth Legions north-west to Shrewsbury and Chester and the Ninth Legion north towards Lincoln. All the eastern side of Britain up to the Humber was occupied probably by A.D. 47, when Britain was annexed to the Roman Empire, and in A.D. 48 or a little later the subjugation of the more hilly country to the north and west began under Ostorius, who succeeded Plautius.

About A.D. 49 Ostorius founded a colony of veterans at Camulodunum with the twofold object of overawing the district and giving the Britons an example of Roman civilization.³¹ The result, however, was unsatisfactory, for the veterans were overbearing and the Roman officials avaricious and tactless.³² The unrest which consequently arose culminated in the rising of the Iceni, a tribe occupying the eastern part of Britain, under their Queen Boudicca or Boadicea in A.D. 62. They were joined by the Trinovantes, in whose territory Camulodunum lay, and to these, we are told, there were added the neighbouring tribes, among which was probably the Catuvellauni. Taking advantage of the absence of Suetonius the governor with the Roman army in North Wales, the confederated British tribes fell on Camulodunum and overwhelmed the garrison. Suetonius hastened south, but not being strong enough to save Verulamium and Londinium, he marched back from London towards Chester. Having collected what troops he could he determined to engage the Britons under Boadicea in the open. The site of their engagement is unknown, but as Tacitus states that there was a forest at the rear of the Romans who came from London and an open plain in

²⁷ Dio Cassius, *Hist. Rom. lib. lx.*

³⁰ Dio Cassius, *Hist. Rom. lib. lx.*

²⁸ Suetonius, *De xii Caesaribus.*

³¹ Tacitus, *Annals, xii, 32.*

²⁹ *Ibid.*

³² *Ibid. xiv, 31.*

A HISTORY OF HERTFORDSHIRE

front, it may very well have been fought on the verge of the forest district in Hertfordshire, all Middlesex being then forest. The Britons were defeated with great slaughter and peace was gradually restored in south-east Britain.³³

In the Flavian epoch the governors—amongst them Agricola—began to encourage the general adoption of Roman civilization, which hitherto, judging from the causes of the revolt under Boadicea, had been mainly confined to the larger towns. In Hertfordshire the places inhabited in the Roman era, Verulamium, Welwyn, Braughing and Hitchin, are all apparently on the sites of British settlements and the association of British and Roman objects points to a gradual Romanization of the district which had begun probably before the Claudian invasion.

The Roman settlements in Hertfordshire follow the lines of the rivers and roads, and are therefore not usually on the highest lands. In the valley of the Chess there were 'villas' at Sarratt and at Latimer just over the county boundary. In the valley of the Gade there were 'villas' at Abbot's Langley, Boxmoor and Hemel Hempstead, while Roman objects have been found at Great Berkhamstead, Northchurch and Wigginton, and a cemetery at Tring gives indication of a settlement. Along Watling Street, which traverses the valleys of the Colne and Ver, were the town of Verulamium and a little settlement possibly near Aldenham. Along the Lea cemeteries mark the sites of settlements at Hoddesdon and Ware, and some way further up the stream remains at Harpenden suggest habitation. On the Mimram was the settlement at Welwyn. In the valley of the Rib there are a 'villa' at Youngsbury in Standon parish, a station at Braughing and a cemetery at Westmill indicating a settlement. In the north of the county there is a considerable group of settlements around Hitchin which belongs to the watershed of the Cam. Here the cemeteries at Pirton, Hitchin, Willian, Norton and Letchworth and the 'villa' at Purwell Mill in Great Wymondley indicate settlements. At Baldock, where Roman remains have been found, there was possibly a small station at the crossing of Stane Street and Icknield Way and another for the like reason at Royston at the crossing of Ermine Street and Icknield Way. At Ashwell and Hinxworth there were cemeteries also which may imply settlements. It seems clear from the disposition of these settlements that the waterways as well as the roads were used as lines of communication by the Romans.

In this fertile district probably most of the settlements were composed of the so-called 'villas,' the properties of large landowners, sometimes Romans, but more often Romanized Britons. These landowners lived in comfortable houses and caused the lands immediately round them to be cultivated by their slaves and let the rest of their land to the half-serf *coloni*.³⁴

The Romano-British houses are mainly of two types which were suitable to the climate and are only to be found in Britain and northern Gaul, namely, (a) the corridor type, showing in plan a row of rooms with a passage or corridor running along one side, or occasionally on both sides, and (b) the courtyard type, having three rows of such rooms with corridors running along three sides of a square with an open courtyard in the middle.

³³ Tacitus, *Annals*, xiv, 33-8.

³⁴ F. Haverfield, *The Romanization of Roman Britain* (ed. 2), 53.

CELTIC AND ROMANO-BRITISH HERTFORDSHIRE

In both types the houses were seldom, if ever, carried higher than the ground floor, and were usually built on a foundation of masonry, above which were timber and plaster, the roof being covered with tiles. They were often fitted with hypocausts and bath-rooms, their floors were decorated with mosaics and their walls with paintings. These types occur in both town and country, though eminently unsuited to the former, as they do not adapt themselves for arrangement into streets. Such were the dwellings in Verulamium and the villas at Boxmoor and Purwell Mill. The remains of the other villas found in the county are too fragmentary to show their type.

Very different, however, was the building discovered at Sarratt, which was oblong in plan, and was, apparently, divided longitudinally into three parts by two rows of timber posts. At one end there was an apse or room. Similar buildings have been found at Spoonley Wood in Gloucestershire, Ickleton in Essex, Clanville, Carisbroke, Castlefield near Andover, and Petersfield in Hampshire and Mansfield Woodhouse in Nottinghamshire.³⁵ In certain instances, as in the case of the building at Sarratt, this type of house apparently bears some relation to a larger dwelling or villa adjoining and may have been the residence of the bailiff.

The hoards found in the county tell us little. An early hoard found at Kimpton, so far as the coins have been identified, covers the period from B.C. 43 to A.D. 15, and a number of coins discovered at Hemel Hempstead, possibly not a hoard, date from B.C. 144 to A.D. 75. No reason for the depositing of either of these can be assigned, but a hoard found at Ashwell which ends about A.D. 180, a recognized hoard period, may have been hidden on account of the Pictish raids of the time of Commodus and the subsequent mutiny of the Roman army in Britain. The hoard discovered at Brickendon, which ends about A.D. 250, and that at Aldbury, which ends about A.D. 272, are probably connected with the troublous times of the latter part of the 3rd century. The later of these dates is perhaps the commonest for hoards in this country and refers to the period of disturbance about A.D. 260–80.³⁶ Another hoard from Cheshunt dates to about A.D. 365, again a disturbed time in Britain by reason of the incursions of the Picts and Saxons.

The only vestige of anything like an industry of which evidence has been discovered is the manufacture of pottery. Kilns have been discovered at Radlett, where the name of the potter 'Custus' can be assigned and the type of pottery, principally mortaria, and the mode of firing could be distinguished. Kilns are thought to have existed also at Aldenham, Great Amwell and Hitchin. These, however, were merely local provisions for local needs and cannot be dignified with the name of an industry.

VERULAMIUM

The site of Verulamium,³⁷ which lies a little to the south-west of St. Albans, has not been systematically explored and so the history of the

³⁵ cf. *V.C.H. Hants*, i, 296, 316; *V.C.H. Notts*, ii, 30; *Arch.* lii, 651.

³⁶ *V.C.H. Leics.* 1, 180.

³⁷ The variants in spelling are: (1) from the coins of Tasciovanus, Verlam or Virlam, Verlamium, possibly Verolamium (*V.C.H. Herts.* i, 239–42); (2) Tacitus gives Verulamium (*Annals*, xiv, 33); (3) Ptolemy has Urolamium; (4) The Antonine Itinerary, Verolamium, Verolamum.

A HISTORY OF HERTFORDSHIRE

town has yet to be written. If such an exploration should ever be undertaken, there is little doubt it would disclose much history of the Late Celtic and Romano-British periods. No object earlier than the Late Celtic age has as yet been found on the site; consequently it may perhaps be suggested that the town was established by the Catuvellauni, a tribe that arrived in Britain about B.C. 200, whose chief stronghold it certainly became. As has been already stated,³⁸ there can be little doubt that Verulamium was the 'oppidum' of Cassivellaunus, Prince of the Catuvellauni, to which Caesar led his troops in B.C. 54. We know the town was then taken and probably sacked by the Romans, but from the evidence of coins and other objects it must have quickly recovered its prosperity. It was during the reign of Tasciovanus, who succeeded Cassivellaunus about B.C. 47,³⁹ that Verulamium seems to have reached the height of its wealth and importance. It remained the seat of his government and from his mint here were issued the earliest known inscribed British coins.⁴⁰ The issue was so large as to indicate wealth, and the Latin inscription on the coins suggests a strong Roman influence.⁴¹ After the death of Tasciovanus, about A.D. 5,⁴² Cunobeline seems to have made Camulodunum the chief town of the two tribal territories, and thereafter, so far as we know, no further coins were struck at the Verulamium mint.⁴³

After the death of Cunobeline, about A.D. 41, Camulodunum apparently remained the seat of government of the Catuvellaunian and Trinovantian princes, for it was by its capture by Claudius in A.D. 43 that the whole of south-eastern Britain was brought under Roman rule.⁴⁴ The Romans apparently adapted the native system of administration in Britain as they had done in Gaul, and governed each Celtic canton or tribal area from its cantonal town. From Verulamium and Camulodunum the territories of the Catuvellauni and Trinovantes were respectively ruled until possibly the government of the two tribes was merged in the time of Tasciovanus. The Catuvellaunian dynasty seems, however, to have assumed an overlordship over the Belgic tribes of south-east Britain, and therefore the chief administration over all these tribes was probably conducted from whichever of these two towns happened to be the seat of government for the time being. The Romans, therefore, at once seized and Romanized these towns, their policy being to subjugate the country through them by the then existing organizations. Hence it is that Camulodunum was made a 'colonia,' about A.D. 49, and Verulamium probably received the rank of a 'municipium' about the same time, remaining the only town in Britain created a 'municipium' during the Roman occupation.⁴⁵

The 'municipium' was of civil development and, as Professor Haverfield states, was a status given in the early Empire 'especially to native provincial towns which had become Romanized without official action or settlement of Roman soldiers or citizens, and which had as it were merited municipal privileges.'⁴⁶ It seems probable, as he suggests, that Verulamium had

³⁸ *Ante*, p. 122.

³⁹ Evans, *Coins of the Ancient Britons* (1864), 288.

⁴⁰ *V.C.H. Herts.* i, 238-42.

⁴¹ Haverfield, *Camb. Medieval Hist.* i, 371.

⁴² Evans, *op. cit.* 289.

⁴³ *Ibid.* 287, 289.

⁴⁴ Dio Cassius, *Hist. Rom. lib. lx.*

⁴⁵ Verulamium is first referred to as a 'municipium' by Tacitus (*Annals*, xiv, 23) in regard to the insurrection of Boadicea, but it had probably attained this rank some time before

⁴⁶ Haverfield, *Romanization of Roman Britain* (ed. 2), 55.



1

2

3

4

5

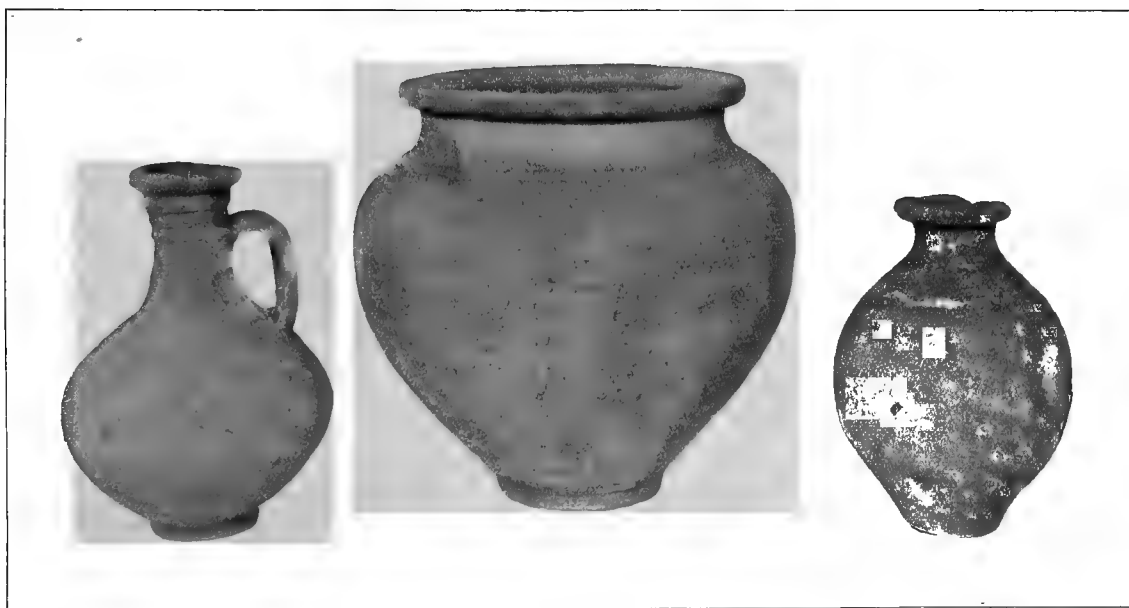

6

7

8

VERULAMIUM AND WELWYN : ROMANO-BRITISH POTTERY IN THE HERTS COUNTY MUSEUM ($\frac{1}{3}$)

Nos. 1, 3, 5. *From St. Michael's.* No. 2. *From Church Crescent, St. Albans.* No. 4. *From the Grange, Welwyn.*
 Nos. 6, 7. *From St. Stephen's.* No. 8. *From Worley Road, St. Albans.*

PLATE II

CELTIC AND ROMANO-BRITISH HERTFORDSHIRE

become Romanized before the Roman Conquest, and so justified the early grant of such privileges. The 'colonia' was of military formation for securing conquered territory by the establishment of time-expired soldiers in provincial towns.⁴⁷ In both, the inhabitants had the rights of Roman citizenship. They were self-governed and were ruled by *duoviri* or presidents of the local assemblies, quaestors and other magistrates, each town having its *ordo* or senate.⁴⁸ Like other cantonal towns each had its forum, basilica, baths, temples, amphitheatre, and Verulamium its theatre.

It was on account of their Romanized condition that during the insurrection of Boadicea the Britons wreaked their vengeance on Camulodunum and Verulamium in A.D. 60. Tacitus dismisses the matter as regards Verulamium by the entry that the inhabitants were put to the sword.⁴⁹ Without accepting the figures of the number of Romans and loyalist Britons massacred in these towns, London and elsewhere, namely, 70,000 as given by Tacitus⁵⁰ or 80,000 by Dio Cassius,⁵¹ it would seem that each town had a large population of Romans and Romanized Britons. It probably took Verulamium and the other towns some time to recover from the destruction which they must have suffered in this revolt, and it would seem likely that in re-establishing them opportunity was taken to introduce the improvements of Roman civilization. Agricola we know made an attempt about A.D. 80 to Romanize the country more completely, and it was possibly about this period that Verulamium was laid out in Roman fashion on a definite street plan.⁵² The excavations on the site of the forum suggest a rearrangement of plan and the earlier plan of that building may be of the Flavian period.

Before the end of the 1st century London on account of its position began rapidly to develop on purely Roman lines till it became the greatest commercial city of the country and the centre of the Roman road system in Britain. Thus, although it never attained municipal or colonial rank, nor was even a cantonal town, it soon entirely overshadowed the more ancient tribal towns of the province in wealth and importance. It would seem that towards the end of the 1st century or during the 2nd century the seat of the central authority of the Roman government in Britain was transferred to it from Camulodunum or Verulamium and the position of these latter towns fell in consequence.

We know practically nothing of the subsequent history of Verulamium. So far as the slight excavations indicate, its buildings were on a larger scale than those found on other Romano-British town-sites, and the existence of a theatre points to wealth. The inhabitants were official and commercial, and so far as the slight evidence we have goes there is nothing to indicate any military life within the town. If conclusions may be drawn from the evidence of burning in the forum and other buildings, it would appear that the town experienced some disturbance at a date not yet fixed, possibly in the 4th century, when Picts and Saxons were devastating the country.

⁴⁷ There were four 'coloniae' in Britain, viz. Camulodunum (Colchester) established by Claudius about A.D. 49, Lindum (Lincoln) about A.D. 70-80, Glevum (Gloucester) in A.D. 96-8 and Eburacum (York) in the late 2nd or early 3rd century (Haverfield, *The Romanization of Roman Britain* [ed. 2], 48).

⁴⁸ *Ibid.* 50; *Camb. Medieval Hist.* i, 371-3.

⁴⁹ *Annals*, xiv, 33.

⁵⁰ *Ibid.*

⁵¹ Dio Cassius, *Hist. Rom. lib. ix.*

⁵² Haverfield, *Romanization of Roman Britain* (ed. 2), 56; cf. evidence as to the lay out of Silchester and Bath in *ibid.* 56, note 2; *Annals*, xiv, 21; *Camb. Medieval Hist.* i, 371.

A HISTORY OF HERTFORDSHIRE

The accumulation of rubbish in the corridors over the burnt débris, on the top of which a fresh floor level was made, suggests that the town took long to recover itself and the meanness of the repairs certainly denotes poverty.

The episode with which Verulamium is associated in most Englishmen's minds is the alleged martyrdom of St. Alban about A.D. 303. This event is treated elsewhere, but the traditions connected with it and the subsequent visit of St. German in 428 suggest that this town contained an element of Christianity in the 4th century.

Verulamium continued to be inhabited for some time after the withdrawal of the Roman legions from Britain.⁵³ What little evidence has been afforded by excavation seems to show that the final ruin of both the forum and theatre⁵⁴ was caused by neglect and by the hands of the mediaeval despoiler.⁵⁵ Ealdred and Eadmar, Abbots of St. Albans during the early part of the 11th century, destroyed much of what then remained above ground, for the purpose of obtaining material for rebuilding their abbey and preventing the ruins from continuing a resort of robbers and evil-disposed persons,⁵⁶ one of whose barbaric hearths was found on a tessellated pavement in the recent excavations. Thus Verulamium became a quarry for the builders of St. Albans Abbey and the churches and houses of the neighbourhood. Some of the Oolite stones at the base of the tower-piers of the abbey church would fit the beds in the sleeper walls of the forum, and the stone used in the Saxon baluster shafts in the transepts corresponds to stone found in the same Roman building. A great part of the abbey church was built of Roman bricks and some of the relics of St. Albans Abbey were Roman cameos and other ornaments found at Verulamium.⁵⁷ The destruction of the remains did not cease with the mediaeval despoilers. Dr. Stukeley writing in 1724 states that three years before, a good part of the wall was standing, but since then it had been pulled down to the foundations to mend the highways. He adds, 'I met hundreds of cart loads of Roman bricks, &c., carrying for the purpose as I rode through the old city though they have stone cheaper.'⁵⁸ The destruction continued through the first half of the 19th century, so that now except for certain blocks of the city walls nothing remains above ground.

Verulamium covers an area of nearly 200 acres, and its circumference is almost 2 miles.⁵⁹ Its shape is irregular but approaches an oval form, the length being nearly double its width. The site, which is on the slope of a hill rising about 100 ft. from the Ver, which flows on its north-east side, presents

⁵³ Minimi, possibly of the 6th century, have been found on the site.

⁵⁴ R. Grove Lowe, *Description of the Roman Theatre of Verulam*, 16.

⁵⁵ *Gesta Abbatum Mon. S. Albani* (Rolls Ser.), i, 24-8. Geoffrey of Monmouth's account of the defeat of the Saxons at Verulamium at the end of the 5th century by the fabulous Uther Pendragon has probably no foundation (Geoff. of Monm. *Hist. Brit.* bk. viii, cap. 23, 24).

⁵⁶ Corroborative evidence of this was found in the excavation of the theatre, which, it was noticed, had been filled up with artificial soil brought to the site to a depth of 9 ft. (R. Grove Lowe, *Description of the Roman Theatre of Verulam*, 16). By the time that the Saxon part of the chancel of St. Michael's Church was built the Roman level must have been almost at its present depth (some 7 ft. or 8 ft. from the surface), as the foundations of this part of the church are a very little below the existing ground level.

⁵⁷ Wright, *Essays on Arch. Subjects*, i, 275; Cott. MS. Nero, D 1.

⁵⁸ Stukeley, *Itin. Curiosum*, i, 116.

⁵⁹ The area of Roman London was 330 acres, of Cirencester about 240, of Wroxeter 170, of Colchester and Leicester 110, and of Silchester 100 acres (Haverfield, *Roman London: Journ. of Roman Studies* [1911], 152). Mr. J. W. Grover compares its shape and size with Pompeii (*Journ. Brit. Arch. Assoc.* xxvi, 50). Such resemblance, however, must be quite fortuitous.

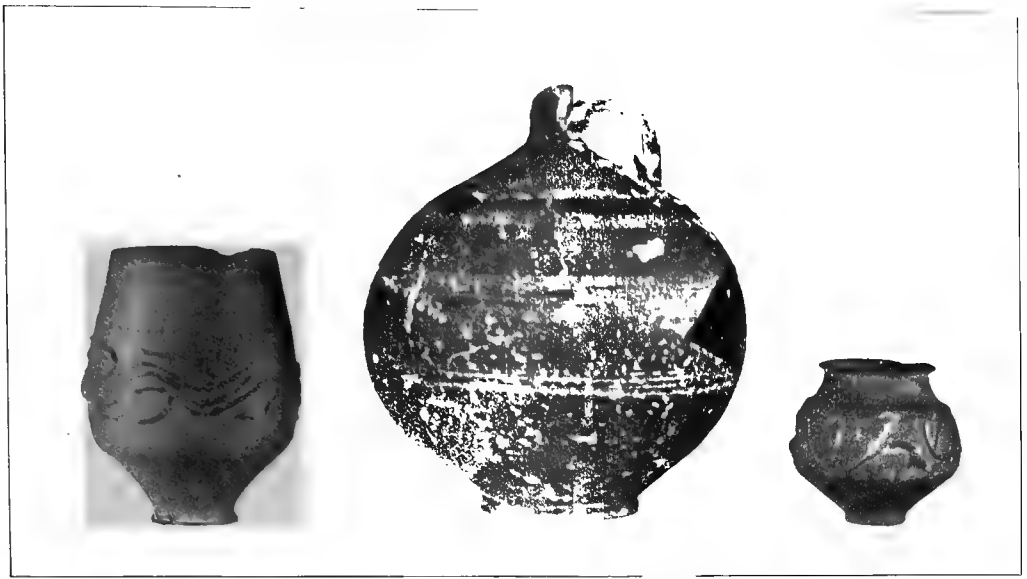

1

2

3



4

5

6

ROMANO-BRITISH AND GAULISH POTTERY IN THE HERTS COUNTY MUSEUM

Nos. 1, 3. *Castor Ware* from *Verulamium*. No. 2. *Painted Ware* from *Verulamium*.
 No. 4. *Samian Ware* from *Worley Road, St. Albans*.
 Nos. 5, 6. *Imitation Samian Ware* from *Verulamium and the Grange, Welwyn*.

PLATE III

CELTIC AND ROMANO-BRITISH HERTFORDSHIRE

no peculiar advantages. It does not stand on a commanding position, being dominated on its south side by the land outside where its defences had to be strengthened by double and deeper ditches. It is on no important river, for, although the Ver may have been larger than it now is, it could never have been navigable for more than quite small boats. It was more or less surrounded by uncultivated forest land and must have drawn its supplies of corn from the fertile lands on the north and north-east of the county. It is true it lies at the crossing of what were two important roads, but whether the site was selected by reason of the roads or the roads made to suit the town is unknown. Such deficiencies of position were the reason why Verulamium, Calleva and other Romano-British walled towns, which had no water communication and were unsuitable as trading centres, were never re-settled after their abandonment by their Romano-British inhabitants. Most of those Romano-British walled towns which had water communication like London, Winchester, Chichester and others were re-settled or some of them were perhaps never entirely abandoned.

The town of Verulamium was surrounded by ramparts and ditches, which are slight on the north-east side, where there was sufficient protection from the lake formed here by damming up the waters of the River Ver. The great dam was later used as a causeway and ran up to the south-east wall. These earthworks, which were thrown up before the Roman period but afterwards perhaps partially remodelled, have been already described.⁶⁰ There is no evidence when they were surmounted by a wall, but Professor Haverfield has pointed out that town walls seem to have been erected in the western provinces of the Empire after about A.D. 250, when barbaric invasions were becoming frequent.⁶¹ On the southern, western and northern sides the wall has a considerable ramp of earth against it on the inside to strengthen it against siege engines and otherwise, while on the outside, where the ground level is about 4 ft. lower than that on the inside, there is a berm or platform some 15 ft. to 20 ft. wide between the wall and the ditch. Both the ramp and the berm are particularly visible on the south side. The wall itself is of flint rubble with bonding courses of tiles varying in the number of tile courses, generally from two to three, but at St. Germans block there is a course of four tiles. These courses do not pass through the wall, being only one tile deep on each side. They are not laid level, but follow the slope of the land. The distance between them varies from 2 ft. 6 in. to 3 ft. The thickness of the wall is from 9 ft. to 10 ft. except at one point on the west side, where it is apparently 13½ ft., but it may be here broken down to the footings. The original height of the wall is not now ascertainable, but the greatest height above ground is 10 ft. Along the east or river side, where there was a lake, the earthworks are slight and the thickness of the wall was apparently only 6 ft. with 2 ft. footings.⁶² The most important pieces of the wall now standing are St. Germans block⁶³ 115 ft. long and 10 ft. high near the south-east⁶⁴

⁶⁰ *V.C.H. Herts.* ii, 110, with plan showing earthworks.

⁶¹ *V.C.H. Somers.* i, 228.

⁶² *Journ. of Brit. Arch. Assoc.* xxvi, 52, and plan; *St. Albans Arch. Soc. Trans.* 1893-4, pp. 51-2.

⁶³ A large hole at the ground level of this block which seemed to imperil its safety was filled up with concrete by the St. Albans Arch. Soc. some years ago.

⁶⁴ In this piece of the wall there are some holes about 2 in. in diameter, clearly made while the wall was being built. Possibly they were for ring bolts for mooring boats on the lake outside.

A HISTORY OF HERTFORDSHIRE

angle; a piece about 400 ft. long and in parts 7 ft. to 8 ft. high along the course of the wall on the south side in the Verulam Woods and some five small pieces in the west wall in the same woods; a piece 58 ft. long and of varying height in a field to the north of Blue House Hill Lane; and Gorhambury block on the west side of Gorhambury Drive 125 ft. long and 10 ft. high. The foundations of a bastion are said to have been found in the Verulam Woods on the southern section of the wall, but otherwise no evidence of bastions has been discovered.

There were apparently four city gates. The principal of these probably was that by which Watling Street entered the town from the south, at the north-east end of the Verulam Woods where the causeway over the fosse is clearly marked. The road from the south-west entered the town by a gateway between the footpath from King Harry Lane to St. Michael's Church and Blue House Hill, where again the causeway to the gate can be seen in the meadow here.⁶⁵ The gate by which Watling Street left the town in its north-westerly direction is not exactly known, but it was apparently on the site of the present road to Gorhambury at Gorham block. The site of the gateway by which the road to Colchester on the north-east left the town is also uncertain, but it was probably near the point where St. Michael's Street crosses the line of the Roman wall. Dr. Stukeley in his plan of Verulamium gives a fifth gate at the south angle of the wall and Mr. Grover follows him in his plan,⁶⁶ but an examination of the site seems to show nothing to indicate this.

Within the town no Roman masonry remains above ground and little systematic excavation has been undertaken to disclose what lies below the surface. Sufficient, however, has come to light to suggest that like other Roman towns it was laid out with streets about 18 ft. wide intersecting each other at right angles.⁶⁷ The principal buildings of which at present we have evidence lie in the middle of the town. Of these that which may perhaps with some confidence be called the forum is in the garden and glebe of St. Michael's vicarage. To the north-west a little way along the Gorhambury Drive on the south side stood the theatre. Fragments of the foundations of other buildings and tessellated pavements have from time to time been discovered, but have been planned or described in a manner that is of little service to the archaeological student.

The partial excavation of the forum of Verulamium (Pl. iv) was undertaken by the writer of this article and the Rev. C. V. Bicknell at intervals between 1898 and 1902.⁶⁸ The site had evidently been built upon before the forum was erected, as it was found that part of the wall of a masonry building at a lower level was cut through by the corridor on the south-west side, showing

⁶⁵ Dr. Stukeley notes in his plan of 1721 that the gate was 'formerly visible,' and Mr. Grover states on his plan that the gate was visible in 1700 (*Journ. Brit. Arch. Assoc.* xxvi, 48 and plan). Excavations were made in 1895 by the author on the spot shown in Mr. Grover's plan, and it was found that the wall had here been grubbed up and it appeared that the gateway was westward where there were indications of the causeway over the ditch.

⁶⁶ *Vetusta Monum.* i; *Journ. Brit. Arch. Assoc.* xxvi, 44-5, plan.

⁶⁷ Mr. J. W. Grover in his plan of the Roman town shows the intersections of the street at acute angles (*Journ. Brit. Arch. Assoc.* xxvi, 45), but the excavation on the site of the forum indicated the usual plan of intersection at right angles.

⁶⁸ For the fuller account of these excavations see Reports by W. Page in *Trans. St. Albans Arch. Soc.* 1899-1902.

CELTIC AND ROMANO-BRITISH HERTFORDSHIRE

that it had existed before the forum (see A in plan). This earlier wall was of a substantial character. It was decorated on its south-east side with coloured wall plaster of a red colour with a black band. The existence of this wall suggests that the Roman type of building had been adopted at Verulamium at a very early date.

The forum as originally designed must have been a very handsome building and its high colonnades would have had a very imposing effect. It is the largest that has been discovered in this country, the total external length being 373 ft. The surrounding buildings instead of being shops as at Silchester and Caerwent appear to have been public offices and courts or temples. The original building consisted of an open courtyard of rammed gravel, 308 ft. by about 205 ft. surrounded by a corridor 26 ft. wide with an *opus signinum* floor, and entered by a gate on the south-east side and another probably on the north-west. In the middle of the courtyard are remains of some masonry which have not been explored. On the south-west side beyond the corridor was a series of large chambers; the opposite or north-east side could not be explored on account of the churchyard, but there was a large building here, possibly the basilica. The south-east and north-west sides of the corridors bordered on streets. The inner wall of the corridor on the south-west side was broken by two openings 65 ft. and 67 ft. respectively. Each opening was filled by a colonnade of five columns with an intercolumniation of 13 ft. 6 in. centre to centre, as was shown by the beds for the stones supporting the bases of the columns.⁶⁹ The circular base of one of the columns was found in position built over by later work and showed a peculiar construction. It was 2 ft. 10 in. in diameter and was composed of Roman bricks, triangular in shape, with one side curved to form the outside of the base. A similar base, now in the Herts. County Museum, was found near, and many other triangular tiles with one face curved were met with during the excavations. A fragment of a fluted column the diameter of which would be about 2 ft. 9 in. was also found not far off.

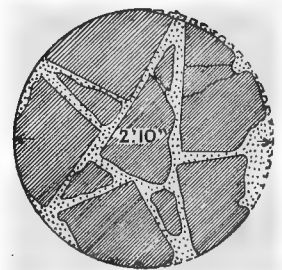

PLAN OF THE CIRCULAR
BASE OF A COLUMN

The intervening spaces between these openings were apparently built up with walls, the upper parts of which were 2 ft. 6 in. thick. At each end of these walls inside the corridor were pilasters corresponding to like pilasters on the opposite side for withstanding the thrusts of the walls of the chambers beyond. In the wall at the south-eastern end of this corridor, between the pilasters, were the remains of the lower part of a doorway 4 ft. 6 in. wide (at B on plan). The jambs were extremely solid and of carefully laid brickwork 4 ft. 4 in. thick with a deep chamfer on the inside. The bricks were set in pink Roman mortar.

So far as the inner wall of the corridor on the north-east side has been uncovered it seems to correspond with the wall last described. The corridor on the south-east side was 26 ft. wide and bounded by walls 3 ft. 4 in. thick.

⁶⁹ These beds here showed the use of blocks of Barnack stone 4 ft. to 6 ft. in length and 1 ft. thick.

A HISTORY OF HERTFORDSHIRE

Its inner wall was formed by a colonnade corresponding with the other colonnades having an intercolumniation of 13 ft. 6 in., the *opus signinum* floor of the corridor passing over the sleeper wall of the colonnade between the bases of the columns. The outer wall of the corridor bordering on the street has a smooth and level surface as though it had formed a bed for a continuous line of large blocks of stone. If this were so, it probably carried a colonnade also. The entrance to the courtyard which cut through this corridor was 22 ft. wide and was flanked by walls 5 ft. thick which supported the entrance arch. The corridor on the north-west side was not explored, but it possibly corresponded to this.

The buildings opening on to the south-west corridor were elaborate. In the middle was a large chamber 62 ft. 9 in. by 40 ft. (internal measurements), having rubble walls 3 ft. 10 in. thick with brick bonding courses. The south-west (outer) end was apparently square, but the walls here were not followed through. The floor seems to have been tessellated but lay too deep below the surface to be properly examined without considerable expense. The chamber itself was entered from the corridor by a doorway 5 ft. wide, and at its north-east corner was another doorway 8 ft. 6 in. wide which led down by three steps of about 8 in. deep into a smaller chamber 39 ft. by 15 ft. 6 in. The walls of this chamber were 3 ft. thick; its floor was paved with coarse red *tesserae* in good condition and it had an entrance from the corridor 3 ft. 8 in. wide on its north-east side. On its south-west side stood a semicircular apse 15 ft. diameter, which seemed to have been added at a later date, as it was not bonded into the wall of the chamber and a space sufficient to run a knife existed between the two walls. The apse is solid and the existing surface is 5 in. below the floor level of the chambers. Both these chambers were plastered and coloured inside in the usual way. There were indications of a corresponding chamber on the other side of the middle chamber, remains of the doorway and the offset of the south-west wall being found, but were not followed out.

The outer wall of the corridor, 3 ft. 6 in. thick, was between the chambers possibly a sleeper wall for a colonnade. It continued south-east 32 ft., where there was another large chamber 63 ft. 9 in. by 34 ft. 6 in. (internal measurements). At the south-west end of this chamber was a large apse, 20 ft. wide, which was raised some 4 ft. 8 in. above the floor of the room, but no approach to it by steps or otherwise now remains. The upper surface of the floor of the apse is broken away. The side walls of the chamber were 8 ft. 6 in. thick, ending at the corridor in pilasters. The thickness of the walls suggested that they supported a vault, possibly a barrel vault, and corroborative evidence of this was found by the discovery of some curved pieces of painted wall plaster.⁷⁰ In places the walls were 2 ft. above the floor, and here there remained on them some painted wall plaster with the usual roll at the junction of the wall and floor. From the quantities of painted plaster which was found, it was clear that the whole of the interior walls and vault were painted mostly in floral designs in dark olive green and other colours, while the evidence of some fragments of

⁷⁰ For further evidence of a vaulted building here it may be mentioned that little or no charcoal was found, as was discovered in the corridor, where the roof was apparently of wood, and the pavement was much damaged by masonry embedded in it which had apparently fallen from some height.

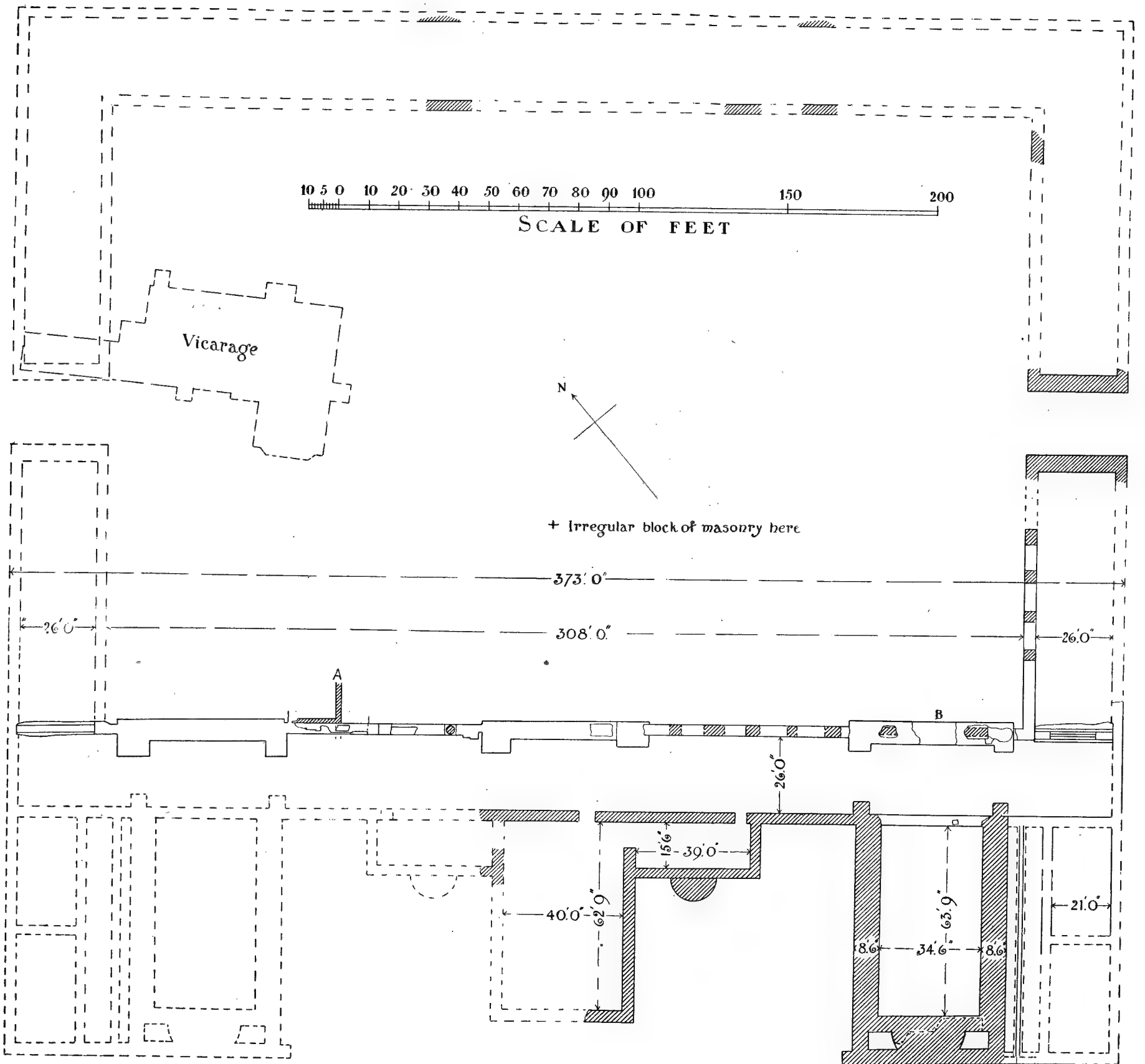

VERULAMIUM: PLAN OF SUPPOSED FORUM
PLATE IV

CELTIC AND ROMANO-BRITISH HERTFORDSHIRE

drapery indicated that there were also figures. The entrance to this chamber must have been from the north-east side, where the wall has been destroyed to a foot below the floor level, and from its present appearance seems to have been a sleeper wall for a continuous course of blocks of stone upon which was possibly a colonnade. On account of the depth of soil little of the floor of tessellated pavement could be examined. From what was exposed, however, it was ascertained that it had an outer border of coarse drab *tesserae* (the *tesserae* being about 1 in. by 1½ in.) which extended from the side walls about 5 ft. 6 in. and rather more from the end walls. Within there was a border of a scale pattern in smaller black and white *tesserae*, and within this again was a very pretty wide braid-work design in black, red, drab and white, and then lines of black and white. Within these borders was the main part of the pavement, which was much mutilated owing to the fallen masonry having become embedded in it, but it appeared that the design was geometric, made up of a series of bands of a scroll pattern in very small red, white, yellow and black *tesserae*. It is difficult to suggest a purpose for this chamber. It may, perhaps, have been a court connected with the forum, the raised apse forming the tribunal.

South-east of this chamber was a narrow passage 3 ft. 2 in. in width, at the bottom of which about 6 ft. or 7 ft. down was a deposit of black mud; but as each end of the passage was blocked by very solid walls it is difficult to understand how it can have been a drain or waterway. Beyond this is a coarse red tessellated pavement 6 ft. 6 in. wide and 76 ft. long, bounded on its north-western side by a roughly built wall 2 ft. 6 in. at the footings and 1 ft. 6 in. above and on its south-eastern side by a sleeper wall 2 ft. 8 in. wide. Beyond this again is another pavement of coarse red *tesserae*, in a good state of preservation, 8 in. above the level of the last-named pavement. It is 21 ft. wide and 76 ft. long, and is bounded on its south-east side by the sleeper wall adjoining the street.

The fact that the inner wall of the south-west corridor, which has been fully excavated, is in its north-western half practically an exact duplicate of its south-eastern half, with foundations for pilaster buttresses in the same position, suggests a duplication of the plan.

At an uncertain date, possibly in the latter part of the Roman occupation, the whole or nearly the whole of the corridors, at all events those on the south-west and north-east sides, were burnt and ruined. Over the corridors on these sides was a layer of charcoal, and at one spot was a considerable quantity of molten lead, which must have melted at a high temperature and fallen in a molten state from a considerable height,⁷¹ while numerous flints and bricks showed evidence of the action of fire. The building must have remained in a half-ruinous state for some time, for over the layer of charcoal is an accumulation of rubbish a foot deep, on the top of which a fresh floor level was made and the corridors were patched and altered. At this time apparently the south-east and north-west corridors were cut off by low walls 1 ft. 2 in. above the old level, possibly to allow for the change of level of the south-west corridor. That on the south-east side has two channels paved with bricks, which, on comparison with similar work at

⁷¹ Information from Professor Gowland, who kindly analysed some of the lead.

A HISTORY OF HERTFORDSHIRE

Silchester, appear to have contained beams which supported the timber framework of double doors. The corresponding wall on the north-west side has no channels, and sags 5 in. in the middle. The colonnades on the south-east and possibly the north-west sides were repaired and remained much as they were, but the north-western of the two colonnades in the south-west wall was apparently taken down and a rubble wall built up in its place, but the evidences at this spot are so complicated that it is difficult to state exactly what was then done. It would seem that the south-eastern colonnade in this wall remained. From the slight excavations on the site of the north-eastern corridor it appears that there are here also similar evidences of fire and alterations.

Among the objects found in the course of the excavation were several pieces of Purbeck marble, some with mouldings and some with a few letters of inscriptions probably of an early type, and one piece of white marble. All these fragments seem to have belonged to the original building of the forum. There was the usual accumulation of potsherds and coins varying from the 1st century to the end of the Roman occupation and five British imitations of Roman coins, probably of the 5th century, two of which might be even of the 6th century.⁷⁹ The evidence of the masonry, particularly that of the chamber with the supposed barrel vault, the fine tessellated pavement in the same chamber and the type of lettering on the fragments of the inscriptions, points to the original building of the forum being of an early date, probably of the latter part of the 1st century A.D.

On the north-east side of the forum portions of the foundations of a large building which apparently ran the full length of the forum (373 ft.) have from time to time been found when digging graves in the churchyard. A length of about 10 ft. of the north-west wall of this building was lately uncovered by the Rev. C. V. Bicknell at a depth of 8 ft. or 9 ft. from the surface in the north-west corner of the vicarage garden, which slightly projects into the churchyard. Here was found a carefully laid wall with a smooth surface 4 ft. 6 in. wide which may have been a sleeper wall for a colonnade or a bed for stones. There was apparently a return wall at the south-west end going south-eastwards, but owing to the roots of trees it could not be examined. On the south-east side were the foundations for a pavement. The immense amount of Roman building rubbish above the foundations indicates a big masonry building, and a layer of charcoal running through the fallen débris points to a fire after the building was wholly or partially a ruin. When St. Michael's churchyard was being made tidy after the rebuilding of the west end of the church in 1897 excavations were made by the Rev. C. V. Bicknell and the writer in the pathways of the churchyard, and 8 ft. from the surface three lines of wall 4 ft. 6 in. to 5 ft. thick parallel to the walls of the forum were found which ran under the church. The middle wall passed diagonally under the north-west corner of the new tower of the church. The wall on the south was about 23 ft. distant from it and that on the north about 28 ft. Five drums of circular columns of Oolite stone were found detached on the top of the middle wall

⁷⁹ All the coins were identified by Mr. H. A. Grueber, F.S.A., of the British Museum, and lists of them will be found in the *Reports* on the excavations in the *St. Albans Arch. Soc. Trans.* 1899-1902.

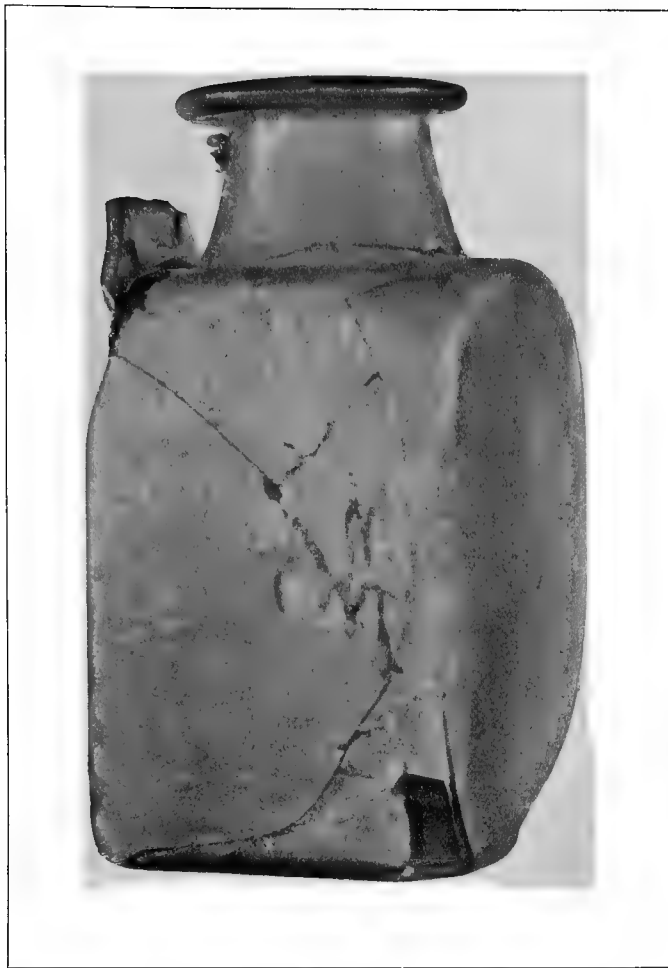

GLASS JUG FROM WORLEY ROAD, ST. ALBANS ($\frac{1}{3}$) IN THE HERTS COUNTY MUSEUM

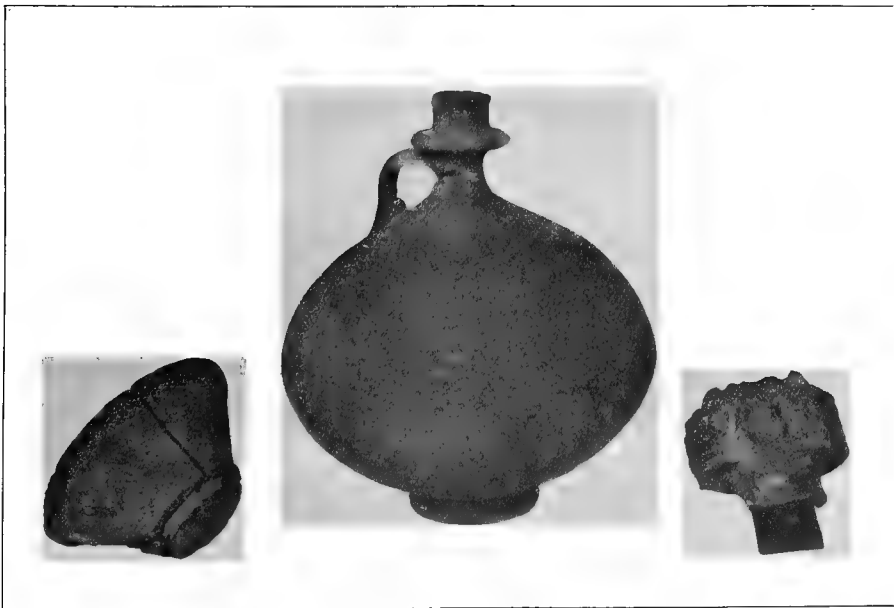

1 2 3
ROMANO-BRITISH RED WARE ($\frac{1}{3}$) IN THE HERTS COUNTY MUSEUM
Nos. 1, 3. From St. Michael's. No. 2. From the Grange, Welwyn.

CELTIC AND ROMANO-BRITISH HERTFORDSHIRE

at the west end of the church.⁷³ They varied in diameter from 2 ft. 1 in. to 2 ft. 2 in. and in height from 1 ft. 8 in. to 2 ft. 2 in. These drums were reddened on one side by the action of fire and charcoal was found under them. They lay with their lewis holes to the north. It seems probable from what can be recovered of the plan of the building, which had apparently a nave and one or two aisles and from its position, that it may have been the basilica. It does not seem, however, to have been attached to the forum as in the cases of Silchester and Caerwent, but the width of a road or rather more seems to have existed between them. Unfortunately the excavations had necessarily to be very fragmentary as, except for the small piece of the wall lately excavated in the vicarage garden, the whole of the building is in the churchyard so that the site cannot be further explored.

The site of the Roman theatre is to the north-west of the forum, about 327 ft. up the Gorhambury Drive from Blue House Hill on the south side of the road. It was discovered in 1847 and excavated in the autumn of that year by the late Mr. R. Grove Lowe, who gave a good report of his work to the St. Albans Architectural Society⁷⁴ in the following year, from which the following details are mostly taken. The theatre consisted of a rectangular stage and adjuncts called the *scena* and an orchestra and seats, comprising 240 degrees of a circle, 190 ft. 3 in. in diameter, called the *cavea* (Pl. vi). It was composed of a stage 46 ft. by 8 ft. 9 in. deep at one side of which was a block of masonry, possibly for an altar. Behind the stage was the *postscenium* or place into which the actors made their exits. On the east side of the stage was a chamber paved with coarse red *tesserae* about 1 in. square, probably for the use of the performers. There was possibly a corresponding room on the west side, but it was not found. In front of the stage was a space 16 ft. 6 in. wide and about 5 ft. below the level of the stage, the purpose of which is uncertain.⁷⁵ It may have been devoted to the chorus so as to give the whole of the limited area of the stage to the actors or, as Mr. Lowe suggests, it may have formed a lower stage for mimes, musicians and dancers or the seats of persons of the highest rank. The plan of the inner wall of the orchestra was uncertain as it was found only at the ends of two of the entrances and about midway between them, and was 6 ft. 6 in., 6 ft. and 1 ft. 10 in. respectively from the third inner wall (see plan). The orchestra, which was on the same level as the space just referred to, usually contained in the Roman theatre the seats of the most distinguished spectators. Behind it were the rows of seats, probably of wood, raised one above another and behind them an arched corridor containing the stairs to the upper part of the theatre, which stood probably where the foundations are shown on the south-east side. Over the corridor were more seats. There were probably three entrances or staircases (*scalae*) leading to the seats, one opposite the stage 7 ft. wide and one on each side 10 ft. wide; only that on the eastern side was, however, excavated. Mr. Lowe estimated

⁷³ On account of adjoining burials only one complete drum could be brought to the surface, and this is now in St. Michael's Church.

⁷⁴ *A Description of the Roman Theatre of Verulam*, by R. Grove Lowe, printed by the St. Albans Arch. Soc. as a separate pamphlet 1848. The theatre was re-opened in 1869 when the British Archaeological Association visited St. Albans, but no fresh discoveries were then reported nor any further account printed.

⁷⁵ The walls shown on the north-west side of the space form only a covered sewer.

A HISTORY OF HERTFORDSHIRE

that the space over the corridor, which was 12 ft. wide including the thickness of the inner wall, would accommodate three or four rows of seats and there would be room for sixteen rows of seats between the corridor and the orchestra, making a total of twenty rows.⁷⁶ This he reckoned would require an elevation of about 25 ft., and allowing the orchestra to be 10 ft. below the level of the corridor the highest seat over it must have been 15 ft. above such level. This would give a building of some height as might be expected from the thickness of the outer wall, which was 5 ft. 9 in. The inner wall of the corridor was 3 ft. 6 in. and the other walls varied from 2 ft. 6 in. to 2 ft. All the walls inside the theatre were plastered and painted chiefly in red and blue verditer; the prevailing patterns ran in broad lines, some of which were imitation of porphyry and formed compartments or panels. The walls were of the usual Roman construction of flint rubble with bonding courses of tiles and tile quoins. Pink mortar was partly used. The Roman theatres were roofless and there would probably be a difficulty in covering the large space of the Verulamium theatre with the materials available without some system of columns, of which there appears to be no evidence. The drain from the orchestra also supports the view that the building had no roof. The discovery of many fragments of roofing tiles may, however, suggest that the stage and rooms attached were roofed. The front of the theatre facing the road was discovered in the following year⁷⁷ (1850), and two fragments of a column of Oolite stone, 24½ in. diameter, are suggestive of a portico with a colonnade usually found with Roman theatres. Some slabs of white marble ½ in. thick were found.

A portion of the foundations of another important building was at the same time found on the opposite side of the road. The fragment excavated, which is too slight to suggest its purpose, is shown to the north-east of the theatre in the accompanying plan.

The only objects found during the excavation were a brass brooch with apparently an enamelled centre, some fragments of green glass and many potsherds, including two fragments of Samian ware bearing the makers' names 'Donat' and 'Sev.' One hundred and seventy-one coins were picked up ranging from Tiberius (A.D. 14-37) to Arcadius (A.D. 383-408), which covered the whole period of the Roman occupation.

Dr. Stukeley marks on his plan of Verulamium made in 1721 vestiges of a large building on the opposite side of the street bordering the south-east side of the forum. He also marks various other *vestigia*, as he calls them, and pavements.

Mr. J. W. Grover made some excavations in 1869, but he seems only to have dug trenches here and there without attempting to trace out the plan of any building which his trenches happened to cross, hence his excavations and the very meagre record of them are almost valueless except for the section of the river wall and the positions of the roads, which his trenches showed. The Rev. B. Hutchinson, the late vicar of St. Michael's, excavated three rooms of a house on the east side of Blue House Hill, one of which had a tessellated pavement.⁷⁸ In building St. Michael's schools in 1853 a Roman wall and a coarse tessellated pavement 21 ft. by 10 ft. were

⁷⁶ These with the orchestra would accommodate probably about 2,000 persons.

⁷⁷ *Journ. Brit. Arch. Assoc.* vi, 91.

⁷⁸ *St. Albans Arch. Soc. Trans.* 1893-4, p. 60.

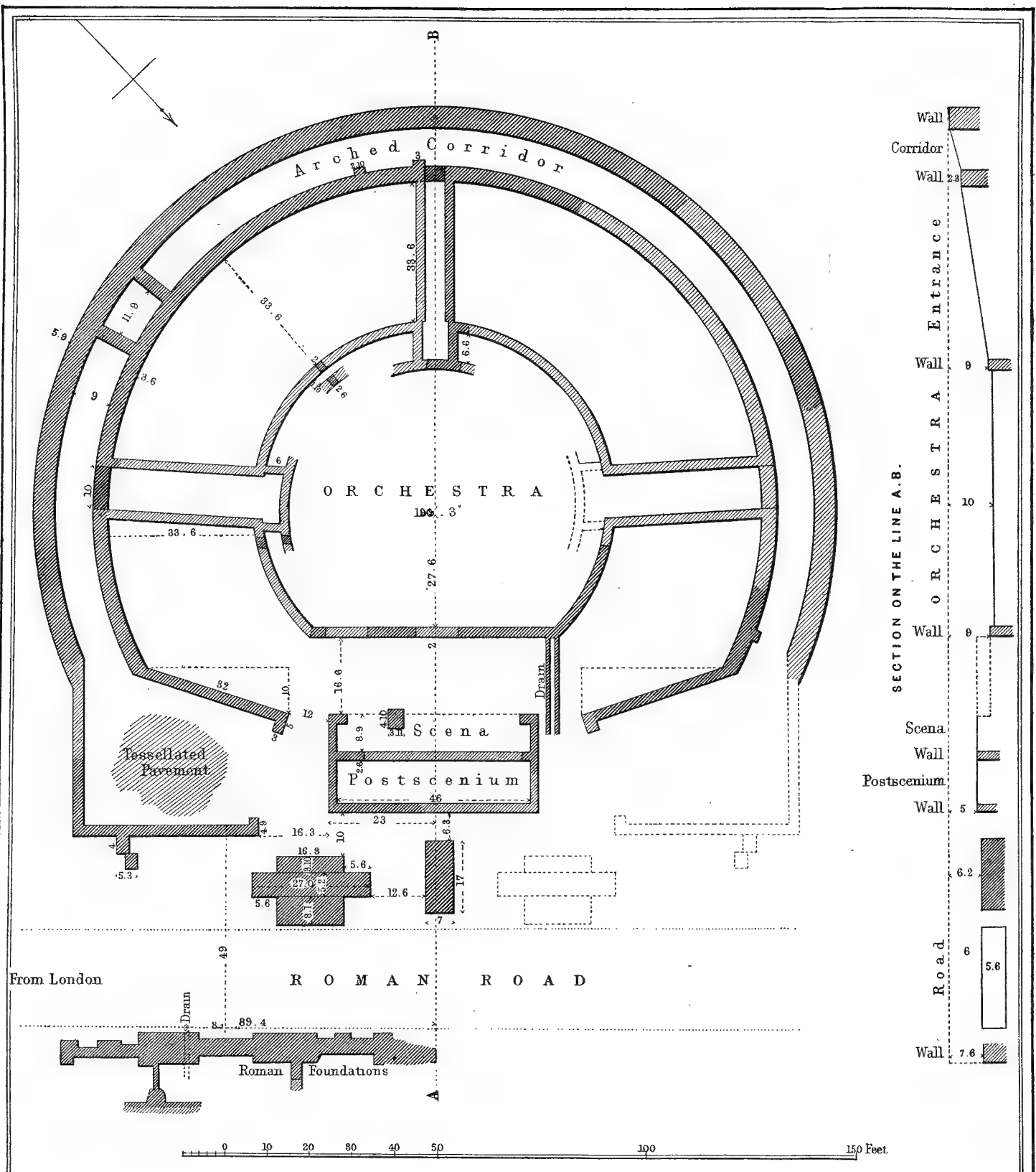

THE THEATRE OF VERULAM.

Dark shade denotes solid Foundations, light shade denotes Walls only in part laid open or only remains of Foundations discovered. Dotted lines are a conjectural Restoration.

CELTIC AND ROMANO-BRITISH HERTFORDSHIRE

found.⁷⁹ In 1905 Mr. Charles H. Ashdown excavated a fragment of a house in the north-west corner of Vineyard Field which showed portions of two pavements, one plain red and the other red with a lighter red band.⁸⁰ Numerous fragments of walls and pavements have been found from time to time in ploughing and digging, but no further excavations have been systematically attempted.

Innumerable coins have been found on the site from British to early Byzantine and mediaeval. Of Roman coins perhaps the commonest are those of the 3rd century.

Antiquities of various kinds have frequently been discovered, but records of them have seldom been kept. Roman pottery is of course constantly being turned up but has not been systematically classified. Two small bronze female figures some 3 in. high have been found (Pl. xi), and Dr. Stukeley mentions 'a little brass lar or genius alatus' from Verulamium, in the collection of Sir Robert Cornwall.⁸¹

According to Roman practice the cemeteries lay along the roads outside the towns. In the case of Verulamium three groups of burials have been discovered, one along the line of Watling Street, a second to the

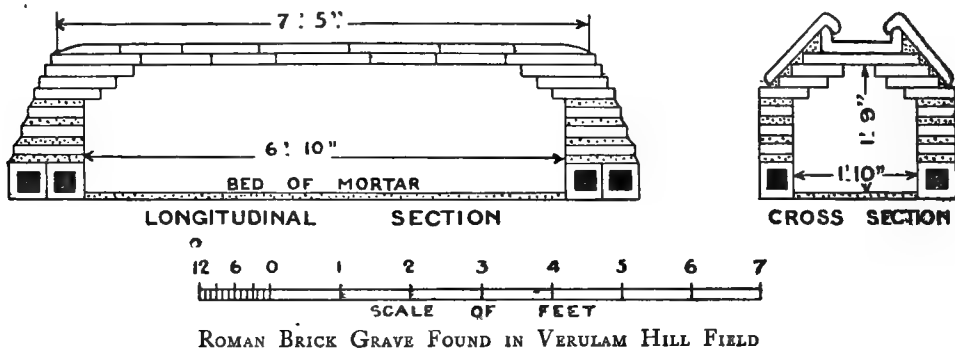

south-west of St. Albans Abbey, unconnected as far as we know with any Roman road, and a third associated with the road going north-east from Verulamium, probably to Braughing and Colchester. There is, as yet, no record of the discovery of burials outside the town along the roads leading north-west and south-west. With regard to the first group, both cinerary urns and burials by inhumation have been found in the field called Verulam Hill Field belonging to Mr. Charles Woollam, J.P., to the south-east of the Roman town. In 1877 there was discovered a rectangular brick grave 6 ft. 10 in. long and 1 ft. 10 in. wide internally with the long axis running north and south.⁸² The floor was of mortar on a bed of chalk and the sides were composed of a course of hollow hypocaust tiles double at the ends and above them ordinary Roman tiles set in mortar to a height of about 1 ft. The roof was formed by an arrangement of overlapping tiles, above which was a line of flanged roofing tiles having on either side a coping of sloping

⁷⁹ *Arch. Journ.* v, 357; *Journ. Brit. Arch. Assoc.* v, 360.

⁸⁰ *St. Albans Arch. Soc. Trans.* 1905-6, p. 167.

⁸¹ Stukeley, *Itin. Curiosum*, i, 117.

⁸² *Times*, 10 Nov. 1877. The skull was given to Professor Rolleston and is now in the Department of Comparative Anatomy, The Museum, Oxford. The pot is in the possession of Mr. Charles Woollam and the remainder of the burial was re-interred. The discovery was examined by the Rev. H. Fowler, from whose sketch the accompanying drawing is made.

A HISTORY OF HERTFORDSHIRE

roofing tiles. Within the tomb was the well-preserved skeleton of an adult male. On the right-hand side of the skull were the bones of a bird, and near the right hip the fragments of a small pot with some pieces of burnt matter. The presence of numerous iron nails and some decayed wood indicated that the body had been interred in a coffin. What was possibly the foundation of a similar grave was opened by the writer in the same field in 1893. It consisted of a layer of ordinary Roman tiles covering about 6 ft. 6 in. by 3 ft., about 2 ft. from the surface, upon which lay a number of smaller tiles. Some hypocaust and roofing tiles were also found, together with an iron nail and many bones, none of which, however, appeared to be human. At one end were discovered the nether stones of two Roman querns or hand mills 15 in. in diameter, some fragments of pottery, one of which was ornamented with a human mask.⁸³ In digging for the foundations of the houses along the east end of King Harry Lane, and in laying out their gardens, numerous cinerary urns (Pl. vii) were discovered on either side of Watling Street, the paving of which was here found. On the opposite side of St. Stephen's Hill several cinerary urns have also been found in St. Stephen's churchyard. In 1848 a Roman grave was discovered in the churchyard containing a greenish glass hexagonal jug or bottle (14 in. high, 9¾ in. diameter) with reeded handle, used as a cinerary urn and containing calcined bones, a small glass *unguentarium* (6 in. high), a one-handled jug of ordinary Romano-British ware (6½ in. high, 4½ in. diameter), a Samian patera and two pots and an earthenware lamp of ordinary Roman type.⁸⁴ A skeleton was discovered about 1850 outside the south side of Verulamium and around it were seven pots containing ashes. At the left shoulder was a bronze *fibula* of open-work design but much corroded.⁸⁵

With regard to the second group of interments, Mr. Roach Smith in 1847 exhibited to the Archaeological Association some drawings of Roman cinerary urns, filled with burnt human bones, in the collection of Mr. George Gwilt, which had been discovered some years previously in a meadow lying 'from one to two furlongs' from the south-west angle of the nave of the abbey church. Other cinerary urns were discovered about the same time by the Rev. Dr. Nicholson, rector of St. Albans,⁸⁶ and some of them are now preserved in the Watching Loft in the abbey church. Fragments of Roman pottery have been found in the town of St. Albans, but there is not sufficient evidence to show whether they were associated with burials.⁸⁷

Of the third group of burials a stone coffin, now preserved in St. Michael's Church, was found in 1813 at a considerable depth in a field behind Kingsbury Manor House. Within it, besides the skeleton, were three greenish glass vessels of the usual square jug shape with handles, which are now in the possession of the Earl of Verulam.⁸⁸ Not far from this spot

⁸³ The objects found are now in the Hertford County Museum, St. Albans.

⁸⁴ Pamphlet published by the St. Albans Arch. Soc. *On Some Roman Sepulchral Remains discovered in the Churchyard of St. Stephen's, near St. Albans* (1849), by Mr. H. Bloxam. The vessels are now preserved in the vestry of St. Stephen's Church.

⁸⁵ *Arch. Journ.* 1850, p. 378.

⁸⁶ *Journ. Brit. Arch. Assoc.* (1847), iii, 331; *Arch.* xxxiii, 262.

⁸⁷ In Dagnall Street numerous fragments of pottery have been found. In George Street many potsherds and pieces of Roman brick were apparently carried with earth from the Roman site of Verulam to fill up a hollow.

⁸⁸ *Arch.* xvii, 336.

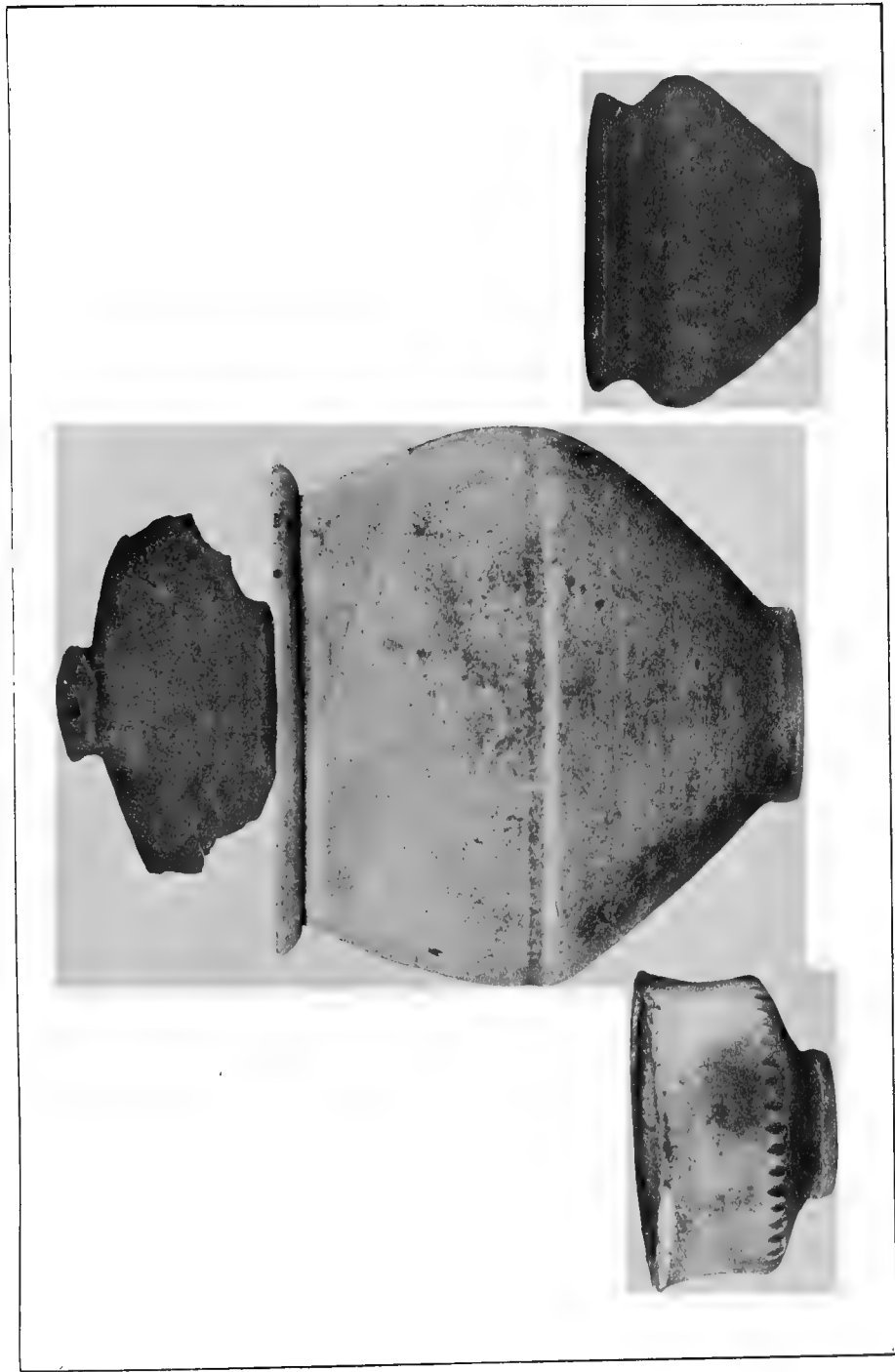

VERULAMIUM : ROMANO-BRITISH POTS FORMING AN INTERMENT AT ST. MICHAEL'S (4) IN THE HERTS COUNTY MUSEUM

PLATE VII

CELTIC AND ROMANO-BRITISH HERTFORDSHIRE

an arched vault was found in 1799 containing a lead coffin inclosing the skeleton of a youth. Many other bones were found at the same time.⁸⁹ During the excavations made at the time of the drainage works at St. Albans, about 1885, many cinerary urns and potsherds were found in Mud Lane, now Harley Street, and about 1900 in cutting the road called Kingsbury Avenue from the Verulam Road to Mud Lane a skeleton was found just under the surface lying north and south with several nails and the outline in the chalk soil of a wooden coffin. Near the head was a coin of Diocletian. Roman urns, apparently cinerary, have been found adjoining Branch Road, Verulam Road, and Church Crescent. In building the houses in Worley Road several cinerary urns were found, and in putting in the drains to 'Fairlawn' in that road two Roman greenish glass jugs (Pl. v) and a patera of Samian ware with the mark 'Advocisi,' apparently parts of a burial, were found.⁹⁰

It is unknown whether there was an amphitheatre outside the walls of Verulamium. Various sites have been suggested for it, including a hollow in the field on the south of King Harry Lane opposite the south corner or the Roman city, which seems to be the most probable.⁹¹

Various earthworks adjoining and near to Verulamium are thought to mark the defences of suburbs, but without excavation it is useless to speculate on the subject.

WELWYN

It would appear from the evidence of burials that there was a Late Celtic settlement at Welwyn. Its exact position is not known, but as the Romans usually Romanized British sites it may perhaps be assumed that it was where the Roman settlement stood, namely, at the crossing of the River Mimram by the supposed road from Verulamium to Camulodunum or Colchester. The Late Celtic burials of the first century B.C. recently discovered are clearly those of some important and wealthy family who, it has been suggested by Sir Arthur Evans,⁹² were possibly members of the royal house of Cassivellaunus. In any case the existence of such burials at Welwyn implies that it was a favoured spot either of veneration if the bodies were brought to it or of wealth if the occupants of the graves had lived in the neighbourhood. The objects associated with two of the burials are of a costly nature (Pl. viii) and some of them had undoubtedly been imported from Italy.⁹³

The Roman site appears to have been on the north-west side of the existing road from Hatfield to Stevenage and to have extended to both sides of the river. Evidence of a house of some size has been found at the rectory and remains of a building near the Grange, while potsherds, coins of

⁸⁹ *Gent. Mag.* 1799, pp. 363-4. The skull was taken to St. Albans Abbey and the lead coffin sold to a plumber.

⁹⁰ One of the jugs and the patera are now in the Hertford County Museum, St. Albans; the other jug was broken.

⁹¹ There are also hollows in the field behind 'Campbellfield,' Mr. A. McIlwraith's house, and in the field to the north of St. Stephen's churchyard, which have been proposed as the site, but the former and possibly the latter have been gravel-pits within living memory.

⁹² *Times*, 28 Feb. 1911, p. 15.

⁹³ The burials were fully reported upon by Mr. R. A. Smith, F.S.A.; see his paper 'On late Celtic Antiquities discovered at Welwyn Herts.' in *Arch.* lxiii; see also Topographical Index under Welwyn.

A HISTORY OF HERTFORDSHIRE

all dates of the Roman occupation, except the latest, and other objects have been found scattered over this side of the town. The cemeteries of the Roman period which lay chiefly to the north and west of what was presumably the inhabited area are well filled, showing possibly that the settlement was fairly populous. The burials so far as they have come to light are all after cremation, a mode which was changed for inhumation in the latter part of the Roman era in this country. It may perhaps be gathered from the present evidence that Welwyn in the Roman period was a fairly prosperous village. It appears that the remains of the two buildings discovered show signs of fire. This together with the evidence of the coins and burials may possibly indicate that the settlement did not survive till the end of the Roman occupation. Perhaps it was destroyed like other settlements elsewhere in the latter part of the 4th century when the country was infested by marauding bands of Picts from the north. Some outlying settlements seem to have existed within a few miles of the town, as for instance at the Frythe, Mardleybury and elsewhere where burials have been found which suggest the proximity of villas or other dwellings.⁹⁴

BRAUGHING

The Roman village or posting station of Braughing lay at the crossing probably of three important roads. The oldest of these may have been the road from Verulamium to Camulodunum, which apparently took this route, but no visible trace of it now remains for some way westward of Ermine Street; the other roads are Stane Street from Colchester to Baldock and northwards and Ermine Street. Possibly there was also a road going north-east to Great Chesterford. The large number of British coins which have been found shows that there was a Late Celtic village here before the Roman occupation. This station has been identified with *Ad Fines*, the first station out of London in the seventeenth Itinerary of Richard of Cirencester. This itinerary, however, was certainly in part forged by Bertram and Richard, and the name *Ad Fines* is not to be found in the Antonine Itinerary nor in the list of the anonymous Ravennas.

The exact site of the settlement has not been discovered. The crossing of the roads, at or near which it probably stood, was apparently at the village of Puckeridge (see Roads). North of this in Wickham Field, near the railway station, numerous remains of cinerary urns, coins and other objects indicative probably of a Roman cemetery have been found. The only evidence of a house was a tessellated pavement found in 1799 at Larksfield within what is supposed to have been some earthworks. This position, however, is too far distant from the road to have been a posting station and the remains may have been those of a villa or country house outside the station.⁹⁵

ROADS

The sources of information with regard to roads of the Romano-British period are archaeological and written. The evidence of the former is

⁹⁴ For details of the finds see under Welwyn in the Topographical Index at the end of this article.

⁹⁵ For details of the finds see under Braughing in the Topographical Index at the end of this article.



1



3



4

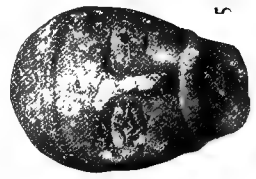

5



2

WELWYN : PAIR OF SILVER VASES AND THREE BRONZE MASKS
PLATE VIII

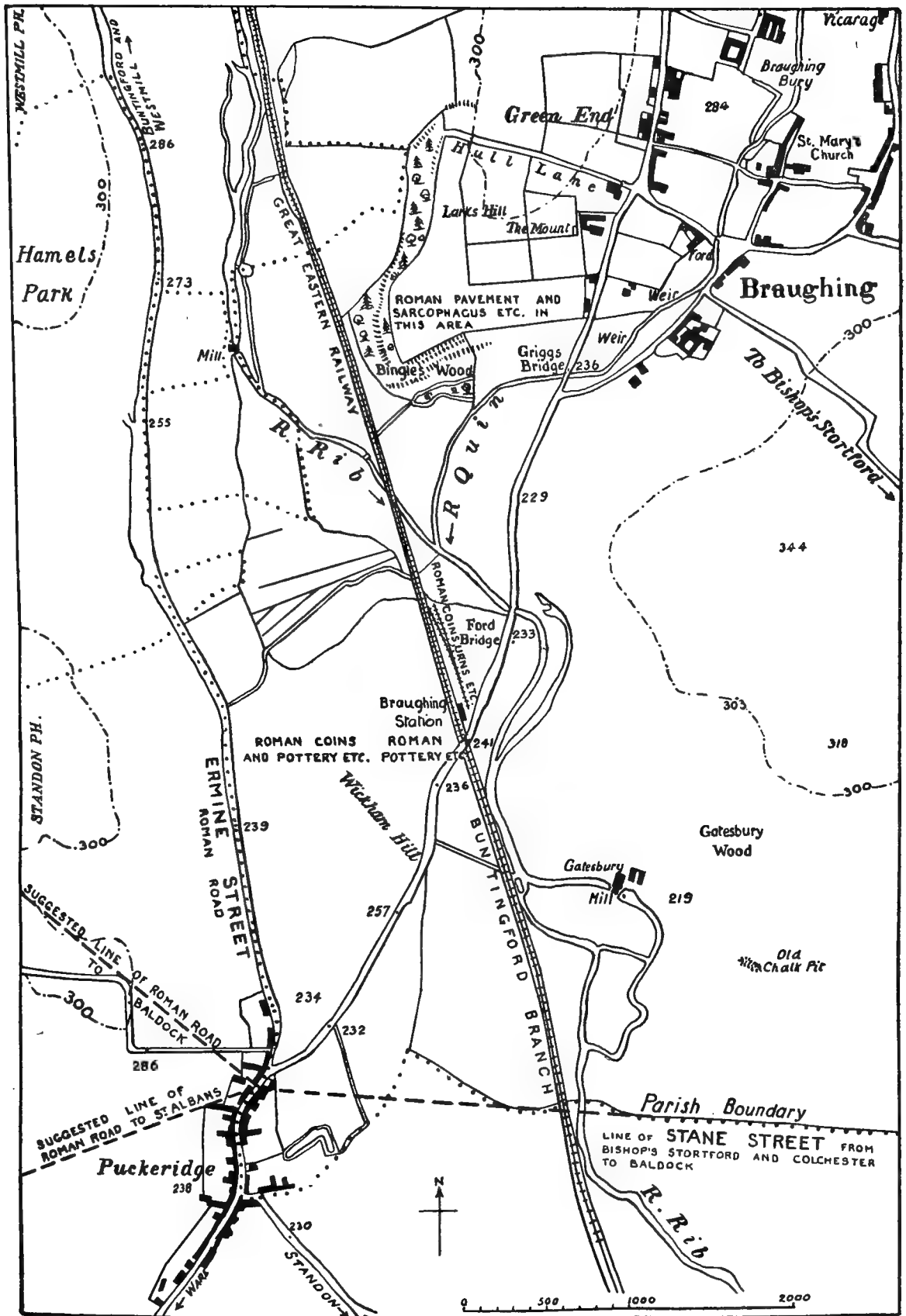

MAP SHOWING ROMAN REMAINS AT BRAUGHING
 Based upon the Ordnance Survey Map, with the sanction of the Controller of H.M. Stationery Office.
 (Scale 6 inches to 1 mile.)

A HISTORY OF HERTFORDSHIRE

obtained by the actual remains of ancient metalling or milestones and occasionally by the persistent straightness with which a still existing track runs from one Roman site to another. The chief written evidence is the 'Itinerarium Antonini,' a Roman road-book which gives the distances and 'stations' along various routes in the empire. Its exact date is uncertain, though it is supposed to have been compiled in the early part of the 3rd century. The only itinerary route which passes through Hertfordshire is Watling Street, which forms a part of the second, sixth and eighth itineraries.

Watling Street.—The considerable traffic which must have existed between Verulamium and the Kentish ports to Gaul and Italy long before the Claudian invasion would require a definite trade route. It is probable that this route followed generally the course which Watling Street afterwards took, particularly over the section between Verulamium and the Thames. Here the British track seems originally to have had for its southern objective the lowest safe ford across the Thames and not London, which would have been its goal had the route been purely a Roman one. After the Romans had established themselves here, probably towards the close of the 1st century, the British trackway may have been straightened and metalled and adapted as a Roman road.⁹⁶

Watling Street starts at Richborough near Sandwich in Kent and passes in a north-westerly direction, eventually reaching Wroxeter. Its course has always been so important that it has continued in use for the greater part of its length to the present day. It enters the county from the south in the middle of Elstree village just after diverging to avoid Brockley Hill. As it passes through the village of Elstree it curves round to take up its straight north-westerly direction again. It forms here the boundary between Aldenham and Elstree parishes and follows the existing road which skirts the east side of Aldenham Park and continues through Aldenham parish and the hamlet of Radlett. A little to the north of Radlett it forms the parish boundary between Aldenham and St. Stephen's⁹⁷ for about half a mile. It then continues through the parish of St. Stephen's, passing through the hamlet of Colney Street, about half a mile north of which it makes a slight curve to the north-east to avoid the River Ver and the marsh land adjoining. It then takes up its north-westerly course again through the hamlets of Frogmore and Park Street. From Park Street it runs in a fairly straight line to St. Stephen's Church where the present road diverges in a north-easterly direction to St. Albans. The Roman road, however, has been found paved with flints in the usual way with burials on either side, continuing in a straight line through the garden of the house opposite St. Stephen's Church and the field beyond to the south-east of the Roman town of Verulamium. The causeway for the road over the ditch of the town is here quite distinct, and the site of the gateway at the north-east end of the Roman wall in the Verulam Woods can be discerned. The road passes through the town of Verulamium, its course being marked for part of the way by a line of trees.⁹⁸ It passed out of Verulamium on the north-

⁹⁶ *Proc. Soc. Antiq.* (Ser. 2), xxiv, 137.

⁹⁷ Some fifteen years ago the eastern side of the road here for more than a mile was excavated in places to a depth of 15 ft. for drainage works, but no sign of the Roman road was discovered.

⁹⁸ The road was found in the town and said to have been 18 ft. wide (*Norden, Speculum Brit.* 25).

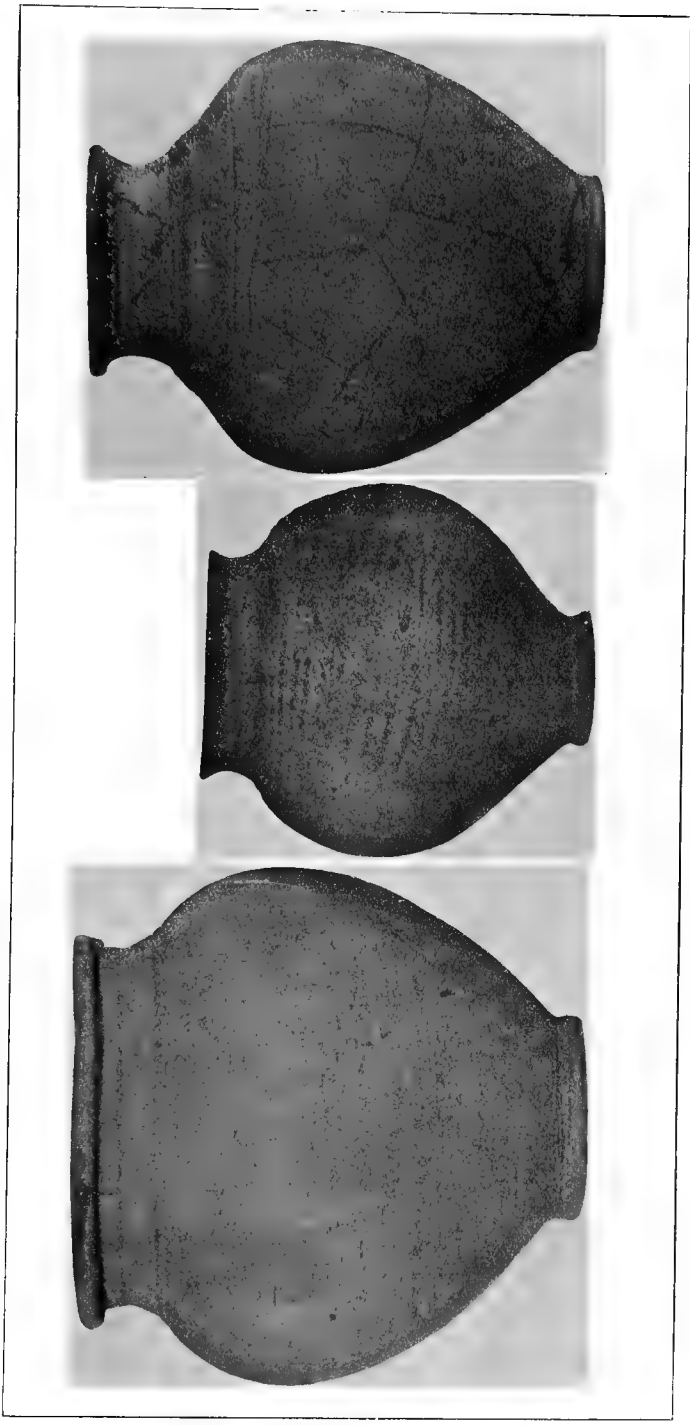

1 2 3

ROMANO-BRITISH BLACK WARE IN THE HERTS COUNTY MUSEUM (1/3)

No. 1. From Cheshunt (with coins). No. 2. From St. Stephen's. No. 3. From St. Stephen's (with coins of Domitian).

CELTIC AND ROMANO-BRITISH HERTFORDSHIRE

east side of the piece of the Roman wall still standing known as Gorhambury Block, and a little north-westward from this point its line can be traced across the fields by a row of trees which formed the boundary of the road which existed till 1833, when it was displaced by the Verulam Road. Its junction with the existing high road to Redbourne on the north-east side of Bow Bridge is still quite distinct. From this point Watling Street follows the line of the existing road through Redbourne towards the hamlet of Markyate Street. Before reaching this hamlet, however, the present road diverges to the west for a mile and a quarter at Friars Wash, forming a loop. The Roman road, however, still exists here as a lane and the two roads re-unite at the point where the boundary between the parishes of Flamstead and Markyate crosses them. Watling Street forms the county boundary between Hertfordshire and Bedfordshire through Markyate and so on till it passes into Bedfordshire.

Akeman Street seems to have been independent of the general scheme of Roman roads in Britain,⁹⁹ and possibly existed as a British track before the Roman occupation. It came from Bath through Cirencester and Alchester (near Bicester) to Aylesbury and so possibly through Verulamium to Colchester. It enters the county from Aylesbury in the parish of Tring, where it deflects from its straight course in order to avoid Hastoe Hill. It passes through the town of Tring by Park Road to the lodge of Tring Park. Here its line is lost, but a little further east it approximately followed the line of a footpath in the park, to the lodge on the east side where it meets the main London Road, forming the parish boundary between Tring and Wigginton, and runs in an easterly course to the south lodge of Pendley Park. Here it turns in a south-easterly direction for about half a mile where the present road diverges from the straight course to a point about half a mile north-west of Northchurch. It then follows the line of the present road through Northchurch to Berkhamstead for a short distance, forming the boundary between those parishes. It forms the High Street of Berkhamstead and continues in a fairly straight line to about a quarter of a mile north-west of Bourne End. The present road continues in a south-easterly direction to Watford and eventually joins Watling Street a little north of Edgware. From Bourne End, however, the present road loses all characteristics of a Roman road, and it appears possible that from this point Akeman Street may have taken a direction almost due east which would bring it to the south-west gate of Verulamium.

A road going west or south-west and north-east from Verulamium apparently existed from the evidence probably of the gates of the Roman town and a street between them. It would seem possible that this road connected Akeman Street with Verulamium, as suggested above, and passed on from that town to join Stane Street to Camulodunum. This route must have been of considerable importance as a line of communication between Verulamium and Camulodunum at the time these were the chief towns in southern Britain. When London, however, took their place and became the centre of the road system of Britain the traffic was probably

⁹⁹ *Camb. Medieval Hist.* 1, 376.

A HISTORY OF HERTFORDSHIRE

diverted to it and this road became of less importance. No indication of it can now be traced on the south-west side of Verulamium. Mr. Grover gives to this part of it the fanciful name of the Camlet Way,¹⁰⁰ but without authority, and marks it on his plan as coming from Silchester but without suggesting its route.¹ A road passed out of the north-east gate of Verulamium but its course is immediately lost, though it seems by the evidence of burials to have gone over the site of Kingsbury Castle, then across the Worley Road towards Sandridge and so to Coleman Green. From Coleman Green to the River Lea there is a straight road for a mile and a half pointing straight to Welwyn, where there was a Late Celtic and afterwards a Roman settlement. After passing through Welwyn there is another straight piece of road towards Stevenage about a mile long. There is then a piece of straight road to Watton at Stone, where by tradition stood a Roman milestone from which the place is said to have taken its name. From thence probably the road went to Braughing where it joined Stane Street to Colchester. This route from Verulamium would skirt the forest area on the south of the county.

Stane Street can be traced for the greater part of its course through the county, but only the section of it from the Essex border to Horse Cross in Braughing parish now goes by this name. In the 14th and 15th centuries, however, we find Stane Street given as a boundary to lands in Cottered and Hinxworth from which it may possibly be inferred that it was then used and known by this name.² It enters the county at Bishops Stortford from Colchester and first appears as a road near Cradle End on the road to Little Hadham, passing through that village on to Horse Cross where the existing road forks to Braughing and Standon. For a part of its course here it forms the parish boundary between Albury and Much Hadham and Braughing and Standon. From Horse Cross the line of the Roman road is lost, but the parish boundary between Braughing and Standon continues in a straight line for nearly a mile and a half to the River Rib as a field boundary. Stane Street crossed Ermine Street probably where that road changes its course to a more northerly direction in Puckeridge. At or near this spot was a Roman posting station (see Braughing, p. 140). The line of the road is lost for about $1\frac{3}{4}$ miles, but it can be picked up again near Furtherfield Spring in the parish of Westmill, where it forms the parish boundary between Westmill and Great Munden and Westmill and Ardeley and is here called Back Lane. It again forms the parish boundary between Ardeley and Cottered and passes through the village bearing the significant name of Hare Street in Cottered parish. It is lost a little further on, but is picked up again near the north of Clothall village and joins the road from Buntingford to Baldock. Here it forms the parish boundary between Weston and Clothall, passing through Baldock by Pest House Lane where it forms the parish boundary between Clothall and Baldock. At Baldock it forms the road to Biggleswade in Bedfordshire,

¹⁰⁰ *Journ. Brit. Arch. Assoc.* xxvi, 48, 50.

¹ The district between Abbot's Langley and the Thames was dense woodland and would be an unlikely course for a Roman road. Such a route would also be too near to Watling Street.

² It is given as a boundary in 1346 (J. Harvey Bloom, *Cart. Antiq. Lord Willoughby de Broke*, 6). It is also referred to in Hinxworth.

CELTIC AND ROMANO-BRITISH HERTFORDSHIRE

which is for about 2 miles the county boundary. It passes out of the county from the parish of Hinxworth.

Ermine Street, which was known by this name or Arning Street in the 14th and 15th centuries,³ comes out of London in a direction almost due north. It enters Hertfordshire in the parish of Waltham Cross and forms the western boundary of Theobalds Park. A little to the north of Bull Cross Farm it is lost in the grounds of Theobalds Park, but is found again at the north-west of the park and approximately follows the line of Burygreen Road to Cheshunt cemetery. It then follows the line of Dark Lane to Goffs Lane, on the opposite side of which it is lost for a short distance in the grounds of Cheshunt Great House; it then follows the western boundary of those grounds to Andrews Lane, on the opposite side of which it follows Stockwell Lane till the lane reaches the brook here. From this point through Cheshunt Park northward through Wormley parish the line of the road is lost and is not found again till the east end of Coldhall Green in the parish of Broxbourne is reached. Here it follows the line of the lane through the grounds of Broxbourne Bury till that lane diverges to the north-west. It can then be traced through the woods to Martins Green, and so northward through Hoddesdon Park Wood by the road called Red Hills, and so northward past Box Wood where under the name of Elbow Lane it forms the parish boundary between St. John's, Hertford and Hoddesdon and Great Amwell. For a short distance it is lost as a road, but its line is carried on by a field boundary. At Hertford Heath it is joined by the road from Hoddesdon and for a little more than a quarter of a mile becomes the main road from Hoddesdon to Hertford. At Little Amwell it again becomes a lane, although still continuing for a little distance as the parish boundary. On reaching the road from Hertford to Stanstead St. Margarets the line is lost, but it followed the boundary on the east of Barrow Field, where it was found in excavating upon the golf links at Chadwell⁴ in 1902. Northward it followed the line of a piece of the parish boundary between Ware and St. John's, Hertford. It probably crossed the Lea a little to the east of the Lock House, where on the north side of the river there was a Roman settlement. Its course is not traceable till it becomes the main road northward to Buntingford where the parish boundary between Ware and Thundridge crosses that road. It then changes its course to a north-easterly direction and follows the existing road to Wadesmill village, thence with a slight deflection eastward through Standon parish to the east side of the grounds of St. Edmund's College, where it again deflects slightly more to the eastward and so on to Puckeridge. At the north end of Puckeridge it probably crossed Stane Street, and near here was a Roman station (see Braughing, p. 140). The existing road loses its straightness for about a mile and a half, and on passing through the village takes a northerly direction, inclining eastward to a point where it crosses the River Rib, there it again becomes straight and goes in a north-easterly direction to Buntingford. For the greater part of the distance from Puckeridge to Buntingford it forms parish boundaries. It forms the Market Hill and High Street of Buntingford and so on in a

³ Cott. MS. Nero E vi, fol. 122b; Anct. D. (P.R.O.), A. 5208.

⁴ *Herts. Mercury*, 5 April 1902.

A HISTORY OF HERTFORDSHIRE

straight course to Corney Bury in Wyddial parish, where the course deviates to an almost due north direction and passes in a straight line through Buckland on to Flint Hall in Royston parish, where it again deflects to the north-west. From Corney Bury to Royston it forms parish boundaries nearly all the way. It passes through the town of Royston, in the middle of which it is crossed by Ickniel Way and so passes out of the county on to Lincoln and northward.

Ickniel Way, though probably of British origin and having few characteristics of a Roman road, yet in places evidently formed a part of the Roman system of communication. It passes from Akeman Street in Drayton Beauchamp parish and enters the county at Tring, which it leaves about 2 miles on its way to Dunstable, where it crosses Watling Street. It enters the county again at Lilley and passes thence through Offley to Hitchin and on to Baldock, where it crosses Stane Street, then on to Royston, forming the county boundary for a part of its course. East and west of Royston it runs in a straight line. It crosses Ermine Street at Royston and so eastward into Cambridgeshire.

There are other roads in the county which have been attributed to the Roman period, such as Ashwell Street, running some 8 miles on the north side and approximately parallel to Ickniel Way, which from its straightness has the appearance of being Roman, but does not lead from or to any known Roman site. The road from Baldock to Graveley and Todds Green and from thence to Stevenage and southward has been considered Roman. It runs in a straight line and forms a parish boundary for part of its course. South of Stevenage are the six well-known tumuli beside it called the Six Hills. A Roman road has been suggested from Braughing in a north-easterly direction to Great Chesterford from the evidence of pieces of straight road, burials beside the road at Braughing, and parish boundaries.⁵ Besides these there are numerous old roads which bear the name of Street, such as Hare Street in Braughing, Silver Street, Theme Street, Sapwick Street, Hay Street and many others, but beyond their names there is no reason to assign them to the Roman period.

⁵ Codrington, *Roman Roads in Britain*, 134.

TOPOGRAPHICAL INDEX

ABBOTS LANGLEY.—The remains of a 'villa were found about 1825 on the borders of this parish about 200 yds. north-west of the station' (i.e., King's Langley station on L. & N.W.R. line). According to the account, it stood on the eastern bank of the River Gade, somewhere quite close to Home Park Mill (Dickenson's Paper Mills). Cussans, our only authority, states that 'within the walls, a tessellated pavement was found, and also a coin of Hadrian, but the excavation appears to have been conducted without much scientific ability.' No plan was published and nothing further has been recorded of this building. A gold coin of Claudius (A.D. 41-54), perhaps Cohen type 43 [but PM instead of GERM], was picked up here some time in the 18th century; [Cussans, *Hist. of Herts. Cashio Hund.* (1881), 86; *Stukeley's Letters and Diaries* (Surt. Soc. 1883), ii, 212; Camden's *Brit.* (ed. Gough, 1789), i, 349]. The villas at Boxmoor lie about 3 miles north-west and further up the same valley.

ALDBURY.—A hoard, or perhaps two, consisting of 118 coins, some metal objects, potsherds and animal remains, were dug up in making a road a few hundred yards south of Moneybury Hill, Pitstone Common, and close to the column to the Duke of Bridgewater, in the spring of 1870. The site may be just over the Hertfordshire border, in the parish of Pitstone (Bucks.). The coins were of the following dates :

<p>1 bronze Cunobeline R/TASCIO [A.D. 5-41] 1 den. Vespasian (Cohen, 574) [A.D. 72-3] 4 second brass Vespasian [A.D. 69-79] 2 " " Domitian [A.D. 81-96] 1 " " Nerva (Cos II) [A.D. 96-8] 4 " " Trajan [A.D. 98-117] 1 first " Hadrian [A.D. 117-38] 3 second " Hadrian (1 Cohen, 369) [A.D. 117-38] 2 first " Pius [A.D. 138-61] 4 second " Pius (1 Cohen, 408) [A.D. 140-3] 1 first " Faustina I (Cohen, 125) [A.D. 138-61] 2 second " Faustina I [A.D. 138-61] 6 first " Marcus (Cohen, 805, 796, 186) [A.D. 164-79] 4 second " Marcus (Cohen, 576, 268) [A.D. 145-71] 2 first " Faustina II (Cohen, 142, 100) [A.D. 161-80] 6 second " Faustina II (Cohen, 101, 209) [A.D. 161-80]</p>	<p>1 first brass Verus Rev. PROPECT. AVG S.C. COS III [C. A.D. 167] 1 " " Lucilla [A.D. 164-83] 5 " " Commodus [A.D. 180-93] 1 second " Crispina [A.D. 180-2] 1 den. Sept. Severus (Cohen, 205) [A.D. 201] 1 first brass Julia Domna (like Cohen, 186) [A.D. 193-211] 2 second " Alex. Severus I (1 Cohen, 505) [A.D. 222-35] 3 " " Gordian III (Cohen, 112, 255) [A.D. 238-44] 1 " " Philip I (Cohen, 111) [A.D. 244-9] 1 third " Gallienus [A.D. 253-68] 3 " " Claudius Gothicus (Cohen, 129, 302) [A.D. 268-70] 1 " " Quintillus [A.D. 270] 1 " " Tetricus I [A.D. 268-73] 2 " " Tetricus II (1 Cohen, 88) [A.D. 268] 17 second " Uncertain 2 third " Uncertain</p>
--	---

and included ancient forgeries of the following :

<p>1 second brass Vespasian [A.D. 69-79] 1 " " Domitian [A.D. 81-96] 4 " " Pius (Cohen, 36, 117, 1083) [A.D. 140-55] 4 " " Marcus (Cohen, 670, 808) [A.D. 154-66] 4 " " Faustina II (1 Cohen, 143) [A.D. 161-80] 1 " " Verus [A.D. 161-80]</p>	<p>1 second brass Commodus (Cohen, 151) [A.D. 186] 1 " " Julia Mamaea [A.D. 222-35] 1 " " Maximinus (Cohen, 15) [A.D. 235-8] 1 " " Maximus (Cohen, 8) [A.D. 236-8] 4 " " Gordian III (Cohen, 123, 406) [A.D. 238-44] 1 " " Otacilia Severa (Cohen, 11) [A.D. 244-9] 4 " " Uncertain</p>
---	---

Cast coins of Pius (Cohen type 497) have been found at Richborough and Verulam. Sir John Evans suggests that this find included two hoards—one of the larger coins ending

A HISTORY OF HERTFORDSHIRE

about 249 A.D., the other of small brass, partly of the Thirty Tyrants, and ending about 270 A.D. The earlier coins were much worn by circulation. The only one of interest is that of Verus. The forgeries were probably cast under Otacilia Severa (A.D. 244). The metal objects included two bronze *fibulae*, one originally tinned and of bow shape, 'with its front plate in the form of a leaf'; the other was circular, 1½ in. diameter, and set with dark green glass and decorated with a bird 'deeply moulded on the flat face of a low truncated cone,' and probably originally filled with enamel, and an 8-shaped pattern punched around the edge between two concentric ribs; also part of a bronze ring, small fragments of thin brass plate, and a penannular ring of silver wire. [Sir J. Evans, *Numis. Chron.* (new ser. 1870), x, 125 seq.; *Herts. Nat. Hist. Soc. Trans.* (1888-90), v, xxiv]. Some Roman coins have been found at Patmore Hall and in Stocks Field, while a number of skeletons were discovered in Longfield, associated with which was a small Roman coin [*East Herts. Arch. Soc. Trans.* ii, 240]. For finds close to, see Northchurch, Tring and Wigginton.

ALDENHAM.—'An immense quantity of broken Roman tiles and pottery at a uniform depth of 4 or 5 ft. from the surface' was found in 1878 in excavations for a swimming bath on the north side of the Grammar School on Boyden's Hill, a mile and a half south-east of Aldenham and three-quarters of a mile west of Watling Street. It was thought to indicate the site of a pottery, a suggestion not altogether impossible, since the Radlett kilns lie only half a mile north-east. [Cussans, *Hist. of Herts. Dacorum Hund.* (1879), 277 n. See also Radlett].

AMWELL.—A number of urns, said to be Roman, and quantities of Roman coins were found in 1847 near Great Amwell Vicarage, which stands in the centre of a mound or other earthwork, formerly known as Barrow or Bury Field, above the valley of the New River. This was excavated in 1848, and as no burials or other objects were found in it, it was thought to be merely a beacon hill. Cussans states in 1876 that little then remained of it, the north and east sides having been recently destroyed. It must not be confused with the Barrow Field near Rush Green in Little Amwell parish, on the line of Ermine Street, 1½ miles west. [*Journ. Brit. Arch. Assoc.* (1848), iii, 324; Cussans, *Hist. of Herts. Hertford Hund.* (1876), 120]. 'Extensive remains of urns, amphorae, &c., together with some of the moulds used,' were found in digging for gravel in 1900, and were thought to indicate the site of a pottery kiln, the necessary clay being found quite close. The exact site in the parish is not given. [Gerish, *East Herts. Arch. Soc. Trans.* i (2), 185-6]. For other finds near, see Hoddesdon, Stanstead Abbots and Ware.

ANSTEY.—Many small fragments of pottery, thought to be Roman, but perhaps mediaeval, were found on the site of Anstey Castle, and some are now in the possession of Mr. R. T. Andrews of Hertford. [*East Herts. Arch. Soc. Trans.* ii (2), 116; Inform. from Mr. Bullen].

ARBURY BANKS.—See Ashwell.

ASHWELL.—Several small finds have occurred at different times at Ashwell and in the neighbourhood. (1) The earthwork at Arbury Banks, half a mile south-west, is not Roman, though Roman objects have been found in and near it. In the course of excavations undertaken here much coarse pottery was turned up out of some circular pits in the centre. Camden and others mention coins from here; in 1820 were ploughed up Roman coins and pottery, and from one vessel a bone die ¾-in. cube, with the pips marked by two concentric circles round a dot; and, lastly, an iron object—a lampholder or hippo sandal—from a pit 15 ft. deep near Arbury Banks. For the earthwork, see *Proc. Soc. of Antiq.* (ser. 1), iv, 285-90, hence *V.C.H. Herts.* ii, 105-6; Camden, *Brit.* (ed. 1607), 290; *Stukeley's Letters and Diaries* (Surt. Soc. 1883), ii, 192; Salmon, *Hist. of Herts.* (1728), 342-3; hence Camden, *Brit.* (ed. Gough, 1789), i, 342; and Reynolds, *Itin. Antonini* (1799), 421. For pottery &c., see *Journ. Arch. Inst.* xiii, 287; xxii, 84. (2) Cussans mentions coins found in Caldecote Field, close to Hinxworth and to the north-west of Arbury Banks, but this may refer to the burials, for which see Hinxworth [*Hist. of Herts. Odsey Hund.* (1873), 23]. (3) In the autumn of 1876 at the coprolite works at Ashwell End, close to the River Rhee and three-quarters of a mile north of Ashwell, a hoard of over 500 well-preserved silver coins from Nero (A.D. 54-67) to Marcus Aurelius (A.D. 161-80) was found. They were encrusted with rust, and were therefore thought to have been inclosed in an iron vessel which had corroded (perhaps wood with iron nails and bands). The earth around was full of calcined animal bones, pottery and potsherds, a stone quern and some small copper coins extending to the end of the Roman occupation. [Cussans, *Hist. of Herts. Addenda to Odsey Hund.* 316]. (4) Some burials were turned up in 1824 in digging for gravel at Foxley Hill, near Slip End, close to Icknield Street, 2 miles south-east of Ashwell. They included several skeletons, six or seven Roman vessels, several black urns, one filled with bones and with a handle, a patella stamped 'MICVIVS' (perhaps Macrinus, Miccius or Miacnus), three lachrymatories and a

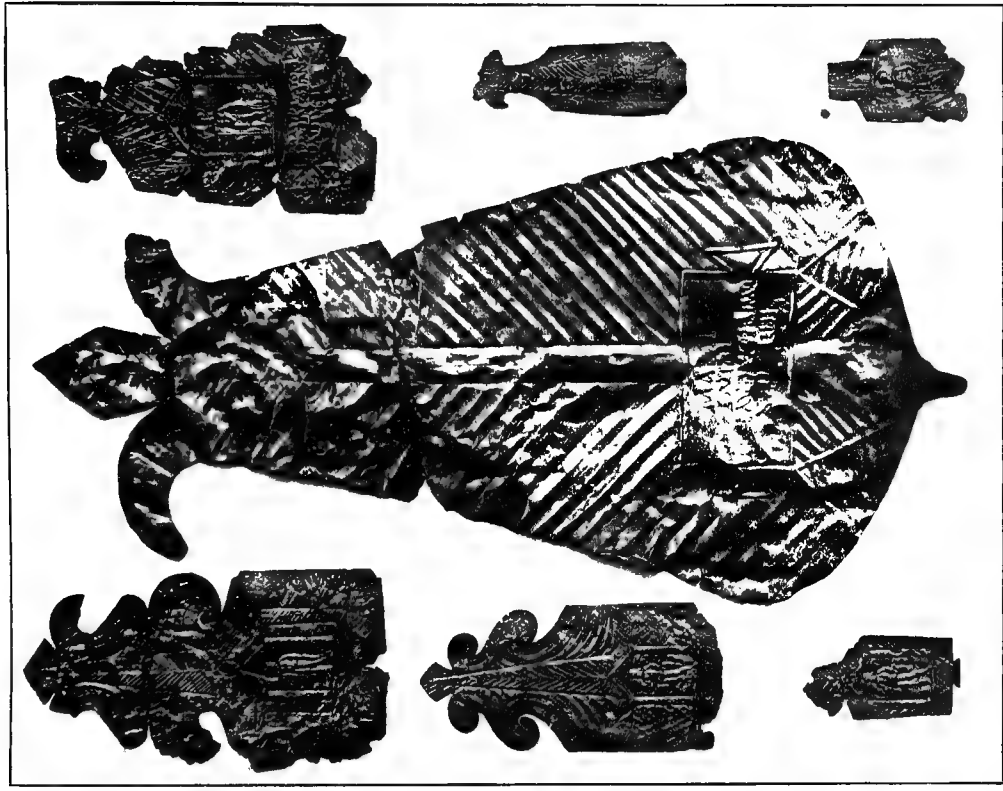
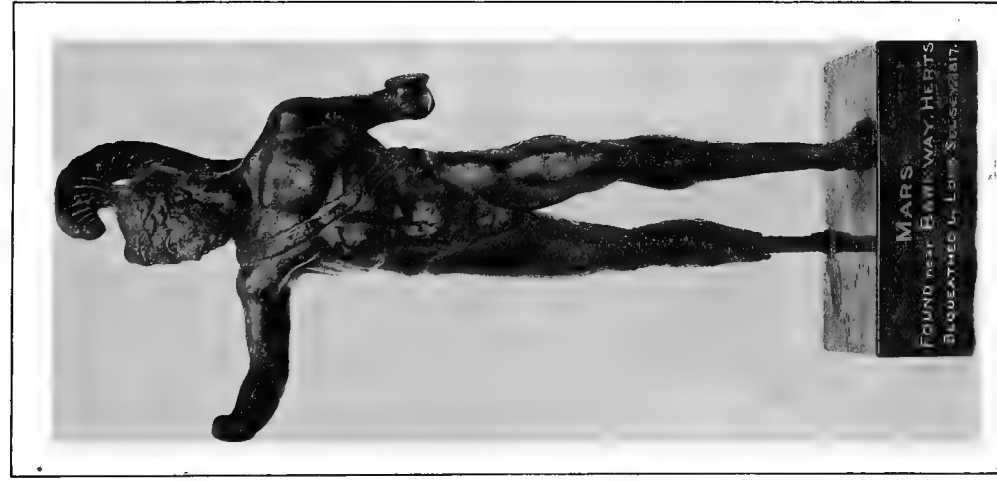

BARKWAY : BRONZE FIGURE OF MARS AND SILVER PLATES WITH INSCRIPTIONS IN THE BRITISH MUSEUM

CELTIC AND ROMANO-BRITISH HERTFORDSHIRE

'polished wood' armilla 4 in. in diameter, all found near the skeletons. Coins were also turned up near here. [Clutterbuck, *Hist. of Herts.* (1815-27), iii, 483 n.; Cussans, *Hist. of Herts. Odsey Hund.* (1873), 23]. Lastly, a gold coin of Trajan (perhaps one of the above) is recorded from here by Sir J. Evans [*Arch.* liii, 253]. A Roman burial was found 1879 at Guilden Morden, Cambridgeshire, a mile east of Ashwell.

AYOT ST. LAWRENCE.—There seems no reason for describing as Roman the stone coffin mentioned by Cussans, *Hist. of Herts. Broadwater Hund.* (1876), 241, and apparently so considered in *Arch.* liii, 253. For the hoard in Prior's Wood, see Kimpton.

BALDOCK.—Several Samian saucers, one stamped 'TASCILLIM' (which is also found in the Low Countries, London and Colchester), and a coin of the *Urbs Roma* type (ex. P.L.N.) were found some years before 1742. The same authority also mentions a coin of Constantine (A.D. 306-37), ashes, bones of men, horses and fowls from a barrow opened about the same time, but which probably belong to a post-Roman burial. An iron object—a hippo sandal or lampholder—8 in. long and 4½ in. at its greatest width, was discovered some time before 1865 near Icknield Street, which runs through the town. [MS. Letter from the Rev. George North, vicar of Codicote, to Ducarel, 4 November 1742, at p. 147 of Gough's copy of Salmon's *Hist.* now in the Bodleian (Gough, *Herts.* 18); *Journ. Arch. Inst.* xxii, 84]. For Wilbury Hill, see Norton; see also Letchworth.

BARKWAY.—A curious and interesting find of bronze and silver objects, now preserved in the British Museum, was made in digging a chalk-pit in Rokey or Rookey Wood, three-quarters of a mile west of Barkway and a mile east of Ermine Street, about 1743. These objects were: (1) a bronze figure of Mars, nude and helmeted, with his right hand up, probably holding a spear, and left down, probably for a shield, but both hands and feet were broken off; it was about 3 in. long (pl. x). (2) A round and moulded handle of a knife or vessel. (3) Seven thin plates of silver, leaf-shaped, three of them having inscriptions pricked or punched on them (pl. x). They measured 3 in. to 8 in. long and 2 in. to 4½ in. wide. On four of them was carved a figure of Mars, helmeted, with spear and shield, standing before a temple. Two bore a figure of Vulcan with his attributes, also before a temple. The seventh, which was much larger, measuring 21 in. by 4 in., had only the following inscription in five lines: 'MARTI TOVTATI, TI(BERIVS) CLAVDIVS PRIMVS, ATTII LIBER(TVS), V(OTVM) S(OLVIT) L(IBENS) M(ERITO).' 'To Mars Toutatis (or Toutates) Titus Claudius Primus, the freedman of Attius, pays his vow.'

The Celtic god Mars Toutates is sufficiently well known. 'Toutates' occurs among other names for Mars in an inscription found in Norica [*Corp. Inscr. Latin.* iii, 5320] and on another at Rome [*ibid.* vi, 31182]. Less certain ones have been found in England at Chesterton [*ibid.* vii, 79], Old Carlisle [*Ephem. Epigr.* iii, 128] and at York [*ibid.* 313, no. 181b]. It seems to be another form of Teutates (or Tutates), the Celtic deity worshipped by human sacrifice mentioned by Lucan [i, 444-5] and Lactantius [*Divin. Inst.* i, 21] and whom Holder connects with Mars rather than with Mercury [*Alt-Celtischer Sprachschatz*: it is derived from *teuta*, people or state; cf. Old Irish *tuath*]. The freedman's name, the arrangement of which is unusual, suggests an early date. The *nomen* 'Attius' occurs more than once on inscriptions in England [*Corp. Inscr. Latin.* vii, 386, 390, 394; Haverfield, *Cat. of Chester Mus.* (1900), no. 20] and is also used as a *cognomen* [*Corp. Inscr. Latin.* vii, 27; cf. also *Ephem. Epigr.* vii, 844].

(2) The second inscription, which was punched on a plate measuring 8 in. by 4 in. below a representation of Mars before a temple, ran 'D(EO) MARTI ALATORI, DUM(?NONIVS) CENSORINVS, GEMELLI FIL(IVS), V(OTVM) S(OLVIT) L(IBENS) M(ERITO).' 'To the God Mars Alator. ? Dumnonius Censorinus, the son of Gemellus, pays his vow.'

An altar to Mars Alator was found at South Shields [*Ephem. Epigr.* vii, 999] and is evidently a local deity. Holder suggests the same interpretation of the word 'alator' as occurs in mediaeval Latin—that is, a huntsman with particular duties [see Ducange]. 'Dum' is expanded into *Dumnonius* by Hübner, and this reading is accepted by Holder. It is hitherto unknown, but it is possible that a provincial (not, of course, a Roman citizen, but one desirous of appearing Roman) might make a *nomen* for himself from the name of his tribe, in this case the *Dumnonii*, who dwelt in south-west Britain. 'Censorinus' occurs as a *cognomen* as well as a *nomen*.

(3) The third inscription is only a fragment punched on a plate measuring 6¾ in. by 3 in. below a figure of Vulcan in front of a temple: NV VLCO—perhaps *numini Vulcono*, 'to the God Vulcan.' 'Numen Vulcanus' is to be found on an altar at Maryport [*Corp. Inscr. Latin.* vii, 398], and apparently 'numen Aesculapius' on another in Gallia Narbonensis [*ibid.* xii, 354].

It is difficult to assign a use to these fragments of metal. Lysons' idea that they are parts of legionary standards is not borne out by the pictures of standards nor by the inscrip-

A HISTORY OF HERTFORDSHIRE

tions themselves. A freedman could not be a legionary, and the name in the second inscription is evidently not that of a Roman citizen. Some inscriptions on similar objects—part of a hoard found some 50 miles west at Stony Stratford in Bucks.—make it clear that they are all to be connected with temples and in our case with the worship of the Celtic representatives of Mars and Vulcan. M. Homolle [Daremberg and Saglio, *Dict. des Antiq.* s.v. *Donarium*, fig. 2539] considers that they were votive leaves for hanging up round a shrine. Somewhat similar leaves, but uninscribed, were found at Dodona [Carapanos, *Dodone et ses ruines* (1878), ii, pl. xlix] and elsewhere [*Bulletin de Corres. Hellénique*, xii (1884), p. 49, fig., p. 50]. The British Museum possesses three silver plaques dedicated to Jupiter Dolichenus, from Hedderheim, near Frankfort, which are not unlike the Barkway plates in shape and ornament, and they are certainly votive objects. One piece has two little holes for riveting it to a wood or other tablet, and no doubt the Barkway plates were also fastened or applied to something more substantial. [Zangemeister, *Bonner Jahrbücher*, cvii, 61-5, pl. vi, 2; also *Brit. Mus. Guide illustrative of Greek and Roman Life* (1908), 40, fig. 26]. It is interesting to observe that, while the Hertfordshire hoard was found only a mile from Ermine Street, the Buckinghamshire find lay close to Watling Street, and it seems probable that both had been stolen or taken from wayside temples or shrines now destroyed and hidden a little distance away by thief or priest [MS. Min. Soc. Antiq. (1745), v, 2; xxxiii, 303; Royal Soc. Letters and Papers, Decade 1, no. 356; *Phil. Trans.* xliii (1746), p. 349, plates i and ii; hence Camden, *Brit.* (ed. Gough, 1789), i, 341; hence Brayley and Britton, *Beauties of Engl. and Wales* (1808), vii, 184; Clutterbuck, *Hist. of Herts.* (1827), iii, 361; Cussans, *ibid. Edwinstree Hund.* (1872), 24; Figured in Lysons, *Reliq. Brit.* (1813), ii, pl. xl, xli, xlii, 1-3; Daremberg and Saglio as above. See also *Corp. Inscr. Latin.* vii, 84-6; *V.C.H. Bucks.* ii, 11; and *Corp. Inscr. Latin.* vii, 80-2].

BENINGTON.—Roman coins found here [Ransom in *Arch.* liii, 254].

BERKHAMPSTEAD, GREAT.—Stukeley records Roman coins from the castle, and especially from the court within it, and concludes it is a Roman site [*Itin. Curios.* (1724), 109, (1776), 116; hence Salmon, *Hist. of Herts.* (1728), 119, who, however, suggests that they belonged to a collection of a mediaeval lord of the castle and came originally from Verulam]. A later record mentions quantities of Roman coins found here at various times [MS. Min. Soc. Antiq. 1813, xxxiii, 233], while recently a Roman lamp was found at the gasworks.

BISHOP'S STORTFORD.—Salmon quotes 'Roman coins of the Lower Empire' found in the castle garden; he saw one of Marcus (A.D. 161-80). Gough was told that some copper coins had been sold some time before he visited the town. Coins of Vespasian, Trajan and Hadrian found here were exhibited in 1867. Bishop's Stortford lies on the road from Colchester to Braughing and at the crossing of the River Stort [Salmon, *Hist. of Herts.* (1728), 271; hence Gough's *Tours in the Bodleian* (MS. Gen. Topog. e. 19), fol. 300; and Camden's *Brit.* (1806), ii, 70; Brayley and Britton, *Beauties of Engl. and Wales* (1808), vii, 214; Reynolds, *Itin. Antonini* (1791), 464; *Essex Arch. Soc. Trans.* (1st ser.), iv, 185].

A small chamber about 6 ft. square, drained by a square hole in the floor just below the centre of one of the walls, was found extending a considerable depth below the surface when excavations were undertaken at the castle and prison about 1850. It was considered Roman because some Roman bricks were found in the wall at the drain-hole, and 'a few pieces of rude Roman vases' mixed up with many mediaeval objects, but the evidence would do equally well for a mediaeval structure. It is just possible that it belongs to some Roman bath buildings [Clarke, *East Herts. Arch. Soc. Trans.* i (1), 54].

BOVINGDON.—See Hemel Hempstead.

BOXMOOR.—See Hemel Hempstead.

BRAUGHING.—On the east of Ermine Street and Braughing, a little to the north-east of the junction of the Quin and Rib streams, the ground rises steeply, making a little cliff some 50 ft. high, running north and east. Some 15 yds. to 20 yds. within this 'promontory' Salmon in 1728 records in a field called 'Larksfeld' the south-west corner of a 'camp.' He observed two ramparts, 10 yds. apart, running west from the road to Barkway, making a rounded corner at the south-west, and triple ramparts running north again to the end of the field. He could trace it no further, but the configuration of the ground suggested an oblong shape, extending as far as 'Down Field' and the road and including 'Saffron Ground,' an area of some 40 acres, cut into two from east to west by Hull Lane. A gateway existed on the south side, which was defended by further earthworks.

Leman about 1815 noticed 'the remains of a vallum of regular shape.' Cussans states that in 1870 'a wide and deep ditch was still visible for a great part of its course.' He supposed Salmon's earthwork to be the mound on Lark's Hill now covered with trees. The bounds of the fields as shown on the O.S. map are rectangular and might have followed the



BRAUGHING : BRONZE BROOCH



BRAUGHING : BRONZE ENAMELLED CUP

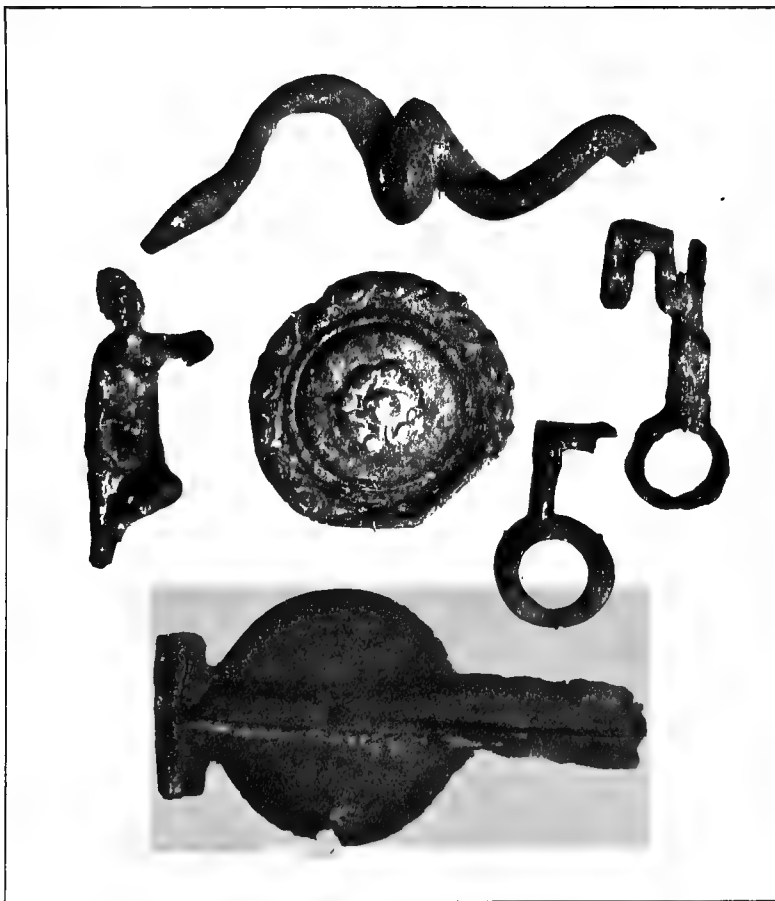

VERULAMIUM : BRONZE AND IRON OBJECTS IN THE HERTS COUNTY MUSEUM

CELTIC AND ROMANO-BRITISH HERTFORDSHIRE

line of the earthwork. Terraced earthworks, descending in a series of steps, still exist on the south and west, but are not easily discernible, since they lie in a densely-wooded game preserve. Professor Haverfield is inclined to connect them with agriculture.

Within this area, according to Clutterbuck, a tessellated pavement of a diamond pattern in various colours was found in July 1799, together with a white marble sarcophagus with a head carved in the centre of one side, and containing a glass vessel and part of the spiral handle of another, a piece of carved bone (? a handle), silver imperial coins, &c., also three amphorae with pointed ends, containing ashes, two ornamented earthen lamps, one with a dismantled trophy and stamped 'MEMI,' the other with a priestess at an altar on it. There is still a tradition of the finding of a pavement beneath the plantation.

In 1725 two large stones were ploughed up in a field called 'West Attick' (adjoining Down Field), and apparently outside the rectangular area, on the north, and 'in the upper corner' of this field 'the earth lies in holes and hillocks, as if some foundations had been dug up' [Salmon, *op. cit.* 227], or perhaps they were only gravel-pits. Another site, 700 yds. south of Lark's Hill, near the Great Eastern station, has yielded more remains. An immense quantity of oyster shells and a few pieces of pottery were turned up in the centre of the road where it is crossed by the railway line, and in making the cutting, extending 100 yds. to the north of the road, 'perhaps thousands of coins' from Augustus (B.C. 31—A.D. 14) to Constantine (A.D. 306—37) in first, second and third brass—including one gold Cunobeline, thirty-two of Cunobeline and Tasciovanus, twenty silver Augustus-Postumus, a fine bronze of Caracalla (A.D. 212—17), thirty 'third brass' of Carausius (A.D. 286—93) and Allectus (A.D. 293)—burial urns, many small objects and quantities of potsherds of all kinds, including Samian. Only one piece with a hunting scene on it is figured or described. Wickhams Field, in which the station is built, is rich in coins, some turning up in every furrow in ploughing, and bones, pottery and coins are still constantly found. Only one find has been described in detail. A bronze enamelled cup, presented by the Rev. Charles Puller to the British Museum in 1870, was exhibited to the Society of Antiquaries in that year (pl. xi). It was $2\frac{1}{8}$ in. high and $3\frac{1}{2}$ in. in diameter, and in shape resembled the Samian bowl, Dragendorf type 37. It was decorated in two bands, with a border. The first band has a wreath pattern in pale blue-green enamel, the lower a scroll and foliate pattern in green on a blue ground, and the border at the bottom consists of a row of vandykes in blue and green. The edges of the bronze were serrated to hold the enamel, which was inserted in the *champlevé* manner. The base was flat and had been soldered on originally, but when found had separated. Similar bowls have been found in Britain and N. Europe. One almost exactly like it came from a peat-bog at Maltbek in Denmark, another with a handle from Linlithgowshire and a third with the same ornament, but different shape, from the Bartlow Hills, Essex, associated with objects dated to the middle of the 2nd century, and this date has, therefore, been suggested for these bowls. Similar enamel work, however, has also occurred on a vessel found with coins of Tacitus from Ambleteuse, N. France. None have been found in Italy or Southern Europe, and they are to be classed with other enamelled objects to be found all over Celtic districts. In December 1892, during the widening of Braughing station, the following Romano-British objects were found and are now preserved in the Board Room Museum, Liverpool Street station, London: A bronze *fibula* ($2\frac{3}{8}$ in. by $1\frac{3}{8}$ in.) ribbed on the back, with spiral spring and pin (pl. xi); a child's bronze bracelet (2 in. diam.); a bronze ear-pick ($3\frac{1}{2}$ in. long); a bronze pin in two pieces ($3\frac{1}{2}$ in. long); an iron ring with fragments of possibly a chain; a bone in (2 in. long); some small pieces of Samian ware and the following coins: A small uninscribed British bronze coin; Augustus Caesar, rev. great altar of Lyons (B.C. 27—A.D. 14), Claudius (A.D. 41—54), Pius (A.D. 161), Tetricus the Younger (A.D. 267), Claudius Gothicus (A.D. 268—70), Carausius, Rex, Pax Aug., local British issue (A.D. 290), Constantine II (A.D. 337) and Constantius or Constans (4th century) (kindly submitted for inspection by Mr. H. Wilmer, F.S.A., M.I.C.E.). The presence of so large a number of finds at this spot indicates something more than a dwelling-house—probably a small posting station or village at the crossing of two roads and a stream, which was occupied at an early date, and perhaps was built on the site of a pre-Roman village. The earthworks at Lark'sfield are of a too uncertain and unsatisfactory character to be identified as the ramparts of a Roman town or village, and in any case the area as given by Salmon seems impossibly large, though he may have been mistaken in his identification of the north and east sides. [Salmon, *Hist. of Herts.* (1728), 226—7; Clutterbuck, *Hist. of Herts.* (1815—27), i, p. xvi (Leman's article), iii, 149, with figs.; Cussans, *Hist. of Herts. Braughing Hund.* (1870), 185—6. From these Gerish, *East Herts. Arch. Soc. Trans.* i (11), 174—5, who adds that a large collection of coins, urns, *mortaria*, *amphorae*, &c., was formerly in the possession of Mr. Newman]. For earthworks, see *V.C.H. Herts.* ii, 108—10, with plan from O.S. Map and sections; the 25-in. O.S. Map, xiv,

A HISTORY OF HERTFORDSHIRE

14 (1878), marks the site as 'Ad Fines,' and the 6-in. Map (1896), xiv, S.W., as a 'camp.' The name 'Ad Fines' is from the forged Itinerary of Richard of Cirencester; the name of this station seems to occur neither in the Antonine Itinerary nor in the list of the Anonymous Ravennas. For the enamelled bowl, see *Proc. Soc. Antiq.* (ser. 2), iv, 514, fig. and references there given; the cup at Maltbek is figured in *Mémoires de la Soc. des Antiquaires du Nord* (1868), 151, plate; at Linlithgow, *Proc. Soc. Antiq. Scotland*, xix, 46; and Bartlow Hills, *Arch.* xxvi, 307, pl. xxxv.; cf. also *Bonner Jahrbücher*, xxxviii, 58, and R. Allen, *Celtic Art* (1904), 137. The site of a house lies about five miles south-west at Standon. See also Westmill. For the supposed Roman milestone between Braughing and Hare Street, see Little Hormead.

BRENT PELHAM.—'Many fragments of vessels, cinerary urns, and a very fine water bottle, with horse-shoes, coins, and other objects,' were found half a mile north or north-west of Chamberlain's Moat [*Andrews, East Herts. Arch. Soc. Trans.* iii (1), 58-60] and are now at Brent Pelham Hall.

BRICKENDON.—A hoard of rather more than 450 Roman denarii was found in 1894 in digging a flower-bed 10 yds. east of Brickendonbury, 1½ miles south of Hertford and a mile west of Ermine Street. They lay on an old surface in a recess cut in the virgin soil, covered with 8 in. of made-up ground—clay and natural soil which is believed to have come from a moat close by. They were for the most part of base metal and of the following dates:

1	Commodus [A.D. 180-93]	144	Severus Alexander [A.D. 222-35]
1	Pertinax [A.D. 193]	3	Sallustia Barbia Orbiana [A.D. 222-35]
33	Septimius Severus [A.D. 193-211]	30	Julia Mamaea [A.D. 222-35]
15	Julia Domna [A.D. 193-211]	19	Maximinus [A.D. 235-8]
20	Caracalla [A.D. 198-217]	1	Maximus [A.D. 236-8]
2	Plautilla [A.D. 202-5]	1	Pupienus [A.D. 238]
8	Geta [A.D. 211-12]	25	Gordian III [A.D. 238-44]
2	Diadumenianus [A.D. 217-18]	9	Philip I [A.D. 244-9]
67	Elagabalus [A.D. 218-22]	1	Philip II [A.D. 247-9]
5	Julia Paula [A.D. 218-22]	2	Trajan Decius [A.D. 249-51]
2	Aquila Severa [A.D. 220-2]	2	Herennia Etruscilla [A.D. 249-51]
15	Julia Soaemias [A.D. 218-22]	1	Herennius Etruscus [A.D. 250-1]
23	Julia Maesa [A.D. 218-23]		

Sir John Evans, who describes them, considers that they were therefore buried about 250 or 251 A.D. Many hoards of similar date have been found in Britain, and were probably deposited in the troublous period of rebellion in the middle of the 3rd century. [Account in the *Numis. Chron.* (ser. 3, 1896), xvi, 191-208; *Herts. Nat. Hist. Soc. Trans.* (1896-8), ix, 169-74. The site is marked on the 6-in. O.S. Map, sheet no. xxxvi, N.E.].

BROXBOURNE.—Two pieces of a grey urn were found within 2 ft. of and a piece of an Andernach lava quern beneath a barrow in a plantation adjoining Broxbournebury Park, on the south side of Cock Lane, opposite Hoddesdon Bury. The barrow was opened in 1901 by Sir John Evans and was thought by him to be post-Roman [*Proc. Soc. Antiq.* xix, 8]. See also Hoddesdon.

CADDINGTON.—For the inscribed *tessera* at Markyate Street, see *V.C.H. Beds.* ii, 7.

CALDECOTE.—See Hinxworth and Ashwell.

CHESHUNT.—The Ordnance Survey (6-in. no. xli, N.E.) marks the western side of a 'Roman camp' in a field called 'Kilsmore,' to the north of Church Lane and west of the New River. Salmon describes it in 1728 as consisting of a 'high vallum with a deep Fosse . . . it seems to have been square or oblong, of which one angle only is left at the north-west, and a part of the west side, the fortification of which is lost in the New River against Church Field.' He refutes the tradition that the origin of the ditch was a channel for the New River, afterwards abandoned for the present line. Stukeley mentions coins of Hadrian (A.D. 117-38), Claudius Gothicus (A.D. 268-70) and Constantine (A.D. 306-37), apparently found in digging gravel for the road. Leman at the end of the 18th century notices 'part of a vallum with its regular fosse, of an oblong figure for an hundred yards . . . which marks the site as originally British, and thence afterwards occupied by the Romans.' Since this date the site has always been held to be Roman on the combined evidence of the earthwork, the name 'Cestrehunt' and its position on Ermine Street, midway between London and Braughing, but no remains other than coins and a pig of lead have been recorded. The site has never been excavated for scientific purposes, and it is now a reservoir. A hoard of about 280 'third brass' coins, Gallienus—Constantine, placed in a blue-grey urn 8 in. high, was found somewhere in the neighbourhood of Cheshunt (the precise site being unknown) about 1904. The urn and

CENTRE LINE OF ROOM

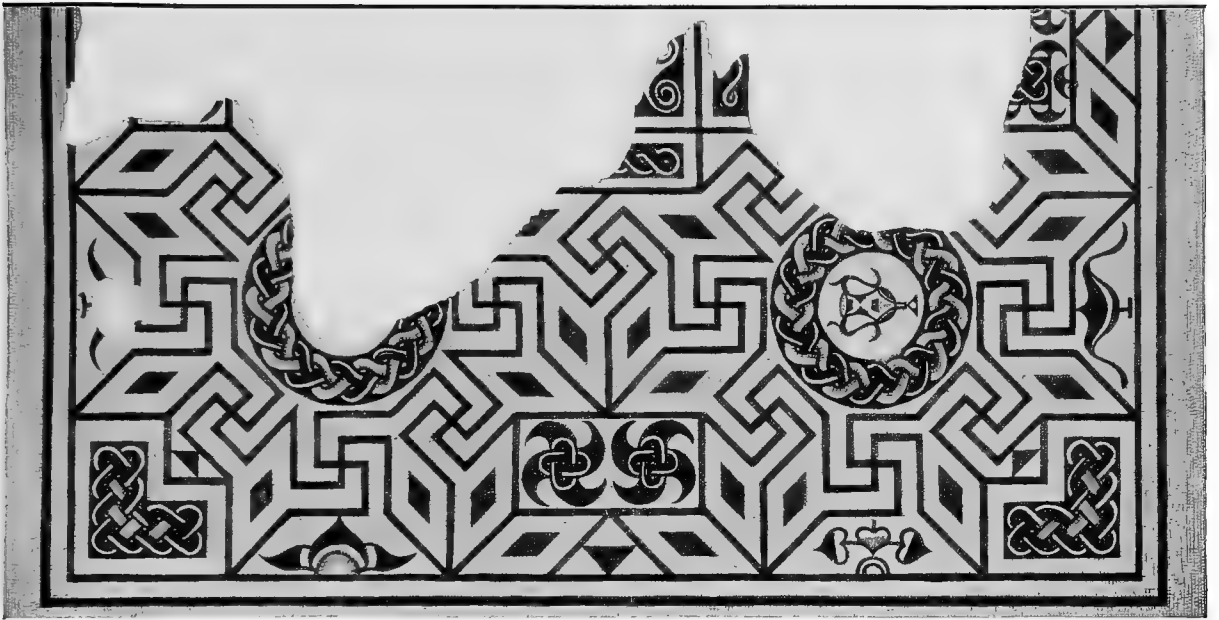

HEMEL HEMPSTEAD : TESSELLATED PAVEMENT AT BOXMOOR VILLA

PLATE XII

CELTIC AND ROMANO-BRITISH HERTFORDSHIRE

twenty-four of the coins are now in the Hertford Museum and are of the following emperors :

5 Gallienus [A.D. 253-68]	1 Constantine I [A.D. 306-37]
1 Salonina [A.D. 253-68]	2 Crispus [A.D. 317-26]
9 Claudius Gothicus [A.D. 268-70]	1 Constantine II [A.D. 317-40]
1 Aurelian [A.D. 270-5]	3 Illegible
1 Probus [A.D. 276-81]	

The earlier coins were very well preserved, the later in bad condition ; the three illegible coins were thought to be Constantinian (A.D. 306-37), and one perhaps Valentinian (A.D. 364-75). The coin of Constantine I bore the London mint mark 'P.LON.' A pig of lead (23·2 in. long), now in the British Museum, was found in 1885 in draining a field at Theobalds Park, not far from Ermine Street. In a sunk panel it bears the following inscription in raised letters : 'IMP CAES HADRIANI AVG,' and on the side in smaller letters is another inscription, probably of some dozen letters, of which the beginning 'LAV' and the end 'vx' or 'xx' only can be read [Prof. Haverfield in *Ephem. Epigr.* ix, 1264a]. Other pigs of lead of the time of Hadrian (A.D. 117-38) have been found in Derbyshire [*V.C.H. Derby.* i, 230] and in Shropshire [*V.C.H. Shrops.* i, 264-5] and at Bath [*V.C.H. Somers.* i, 342]. This was probably lost on its way from the Derbyshire lead mines to London. Cheshunt has also been identified as Caesaromagus and Durolitum of the Antonine Itinerary, but both these places occur on the road to Colchester and not on Ermine Street. [Salmon, *Hist. of Herts.* (1728), 7; *Survey* (1731), ii, 418; Leman, in Clutterbuck, *Hist. of Herts.* (1815), i, p. xvi; hence Clutterbuck, op. cit. ii, 77; Stukeley, *Itin. Curios.* (1776), 77 n.; and MS. Min. Soc. Antiq. 22 April 1724; and a copy of Chauncy, *Hist. of Herts.* in the Bodleian (Gough, *Herts.* 19), p. 297, hence Camden's *Brit.* (ed. Gough, 1806), ii, 71; Brayley and Britton, *Beauties of Engl. and Wales*, vii, 232; *V.C.H. Herts.* ii, 104]. Cussans, *Hist. of Herts. Hertford Hund.* 206, seems to misquote Salmon as to 'coins, urns and other relics' being found in abundance here. For the account of the hoard we are indebted to Mr. Bullen of the Herts. County Museum.

COTTERED.—Stukeley was told of the discovery of coins of the later Empire in a barrow near here. The village lies to the north of the road from Colchester and Braughing to Baldock and Sandy [*Stukeley's Letters and Diaries* (Surt. Soc. 1883), ii, 210].

FLAMSTEAD.—There seems no reason for assigning this as the site of Durolitum. Nothing has ever been found or recorded from here, and the mileage from London and Verulamium does not agree with that of the Antonine Itinerary.

HARPENDEN.—A barrow about 50 ft. in diameter at the base and 20 ft. high, close to Pickford Mill on the River Lea, about a mile north-east of Harpenden (and three of Watling Street), was opened in November 1827 or 1829 and was found to contain a rude and massive cist, in the shape of a round box with an internal diameter of 2 ft. 10 in. and 1 ft. 6 in. deep, resting on a rectangular base, rising slightly at each end, 5 ft. 3 in. long, 3 ft. wide and 11 in. thick, the whole being cut out of one block of hard calcareous grit. It was covered by a rectangular lid of the same size as the base, with a circular groove in the centre to fit on to the box. Within this had been deposited a square pale green glass bottle with reeded handle, 14 $\frac{3}{4}$ in. high and stamped on the bottom with a pattern precisely like that in the Youngsbury barrow (see Standon), four small shallow cups of Drag. type 33, stamped 'ATENIAM' 2 in. high, 'ENIAM' 1 $\frac{7}{8}$ in. high (*Aten[aei] manu* or *Atinianus* or *Ateneacus*—the last two found at Rheinabern), 'BVTTVRRI' 2 in. high, 'BV.VRRI' 2 in. high (*Butturri*, found also at Vichy) [Birch, *Arch. Journ.* ii, 251 seq. figs.; *Gent. Mag.* (1829), ii, 549; MS. Min. Soc. Antiq. xxxvi, 104; *Arch.* xxiv, 349; Cussans, *Hist. of Herts. Dacorum Hund.* 349; Walters, *Cat. of Roman Pottery in Brit. Mus.* (1908), no. M. 2040, 2041, 2057, 2058; see also *Corp. Inscr. Latin.* xiii, 10010-374; Ludowici, *Römischer Töpfer in Rheinabern* (1905-8), iii, 4], the objects being presented to the British Museum in 1843. The site is marked on the 6-in. O.S. Map sheet no. xxvii, N.E., but with a wrong date. 'Remains of Roman interments' were also found in 1867 a little south-east of Harpenden station in making the G.N.R. Luton and Dunstable line. They lay 4 ft. deep and were destroyed at the time. The only objects described are wood buckets with brass bands and handles, consisting of loose rings 2 in. diameter hanging from the mouth of rams, whose nostrils were painted (or enamelled) red. They are not figured, but from the description they would appear to have late Celtic affinities, if they are not actually of that period. Lastly, two silver coins of Gallienus and Salonina (A.D. 253-68) and a 'third brass' of Postumus (?259-69) were turned up in the churchyard about 1860. [Cussans, *Hist. of Herts. Dacorum Hund.* 350]. In the foundations of Top Street Farm, three-quarters of a mile south of Harpenden station (Midland line), are large blocks of stone from an older building, and in the chimney some half-columns and a carved fragment, thought to be Roman. They have been there for the last sixty years, and the farm itself was built in 1650. No similar

A HISTORY OF HERTFORDSHIRE

finds have been made in the neighbourhood, nor even in recent excavations for building, &c.; but it may be noted that the stone cist described above lay for a considerable time in this yard and was used as a trough. [Inform. from Mr. Spencer Pickering and Mr. Liebert for the Hist. Monum. Com.].

HEMEL HEMPSTEAD.—Portions of two dwelling-houses and a cemetery have been uncovered at Boxmoor on the south bank of the Bulbourne stream, about a mile south-west of Hemel Hempstead. The houses lie some 350 yds. apart and are separated now by the L. & N.W.R. station of Boxmoor.

(1) The first was excavated in 1851 by Sir John Evans, but traces of it had been observed previously. It lay beneath a lawn on the east side of Boxmoor House, 300 yds. south of the L. & N.W.R. line and 40 yds. east of Box Lane (Boxmoor-Bovingdon Road), and just within the parish of Bovingdon. The plan below shows a line of four rooms running south-east and north-west at right angles to Box Lane. They were all $23\frac{1}{2}$ ft. long and their respective widths (1) $15\frac{1}{2}$ ft., (2) 18 ft., (3) $6\frac{1}{2}$ ft., (4) 17 ft. The floors, which lay 2 ft. below the surface, were paved in (1), (3) and (4) with ordinary red *tesserae* in a fairly perfect condition; (3) had a short piece of a rude red and white border on one side of the room and (1) had been repaired with fragments of tile. It also showed traces of a cross wall or 'pier of bricks.' But the paved floor of (2) was ornamented with an elaborate geometrical design, in black, white, blue-grey, red and yellow (pl. xii), of limestone, calcareous shale and terra-cotta nearly 16 ft. square, lying not in the centre of the floor, but abutting on one wall and almost overhung by its plaster, the remainder of the space being filled in with a border of common red *tesserae*. Much of this pavement had perished. Its position suggested to the excavators a rebuilding at some date. The pavements were laid on a bed

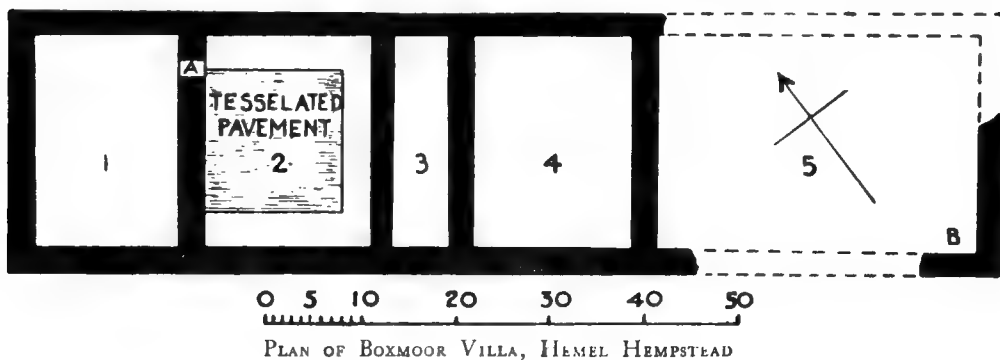

of pounded chalk, and that on gravel. One room only—apparently (2)—bore traces of a hypocaust, connected with a passage measuring 20 in. by 24 in. pierced right through the wall at (A), but 'to the right' of the line of rooms were many fragments of flue tiles, and a fifth room (?5) 'to the left' of them contained the remains of a flue. A detached corner of wall—apparently (B)—was laid open 37 ft. west of these rooms and lay in line with them, and part of another wall, which apparently had no connexion with them. Near this last wall was a deposit of black mould which contained many small objects and was perhaps a rubbish pit. The walls were $2\frac{1}{4}$ ft. to $2\frac{1}{2}$ ft. thick, and were built of rough local flints and mortar imperfectly burnt and not very hard; no bonding courses of tiles were observed, but the wall remained to no great height. The foundation walls did not extend below the level of the pavements. The wall plaster that occurred in the line of rooms was mostly white, but in other parts of the garden there were pieces in many colours in striped and arabesque patterns, and also tiles of all kinds—flue, flange (some of these being used in the foundations) and ridge, many being scored and stamped with a variety of curious patterns. The smaller objects (pl. xiii) included, in bronze, a small round bell with an incised pattern cast on it and a heart in low relief at the bottom near the slit, the head of a hind or fawn with a hollow neck and a small hole on the top of the head, part of a vessel; several strips, one inlaid with ribs of silver or other white metal, perhaps part of a belt or furniture ornament; a finial, a circular *fibula* enamelled in millefiore glass, a ring set with greenish glass and part of another, part of an armilla ornamented with dots; two ornaments, one perforated with a spiral pattern, the other a star-like object with a hole in the centre, both probably harness ornaments; a pin $4\frac{1}{2}$ in. long; a spoon 4 in. long; a pair of broad tweezers with serrated edges, perhaps for domestic use, needle, &c.; two iron knives with blades 5 in. long; a jet pin with faceted head; part of a Kimmeridge coal armilla decorated with transverse lines cut on two mould-

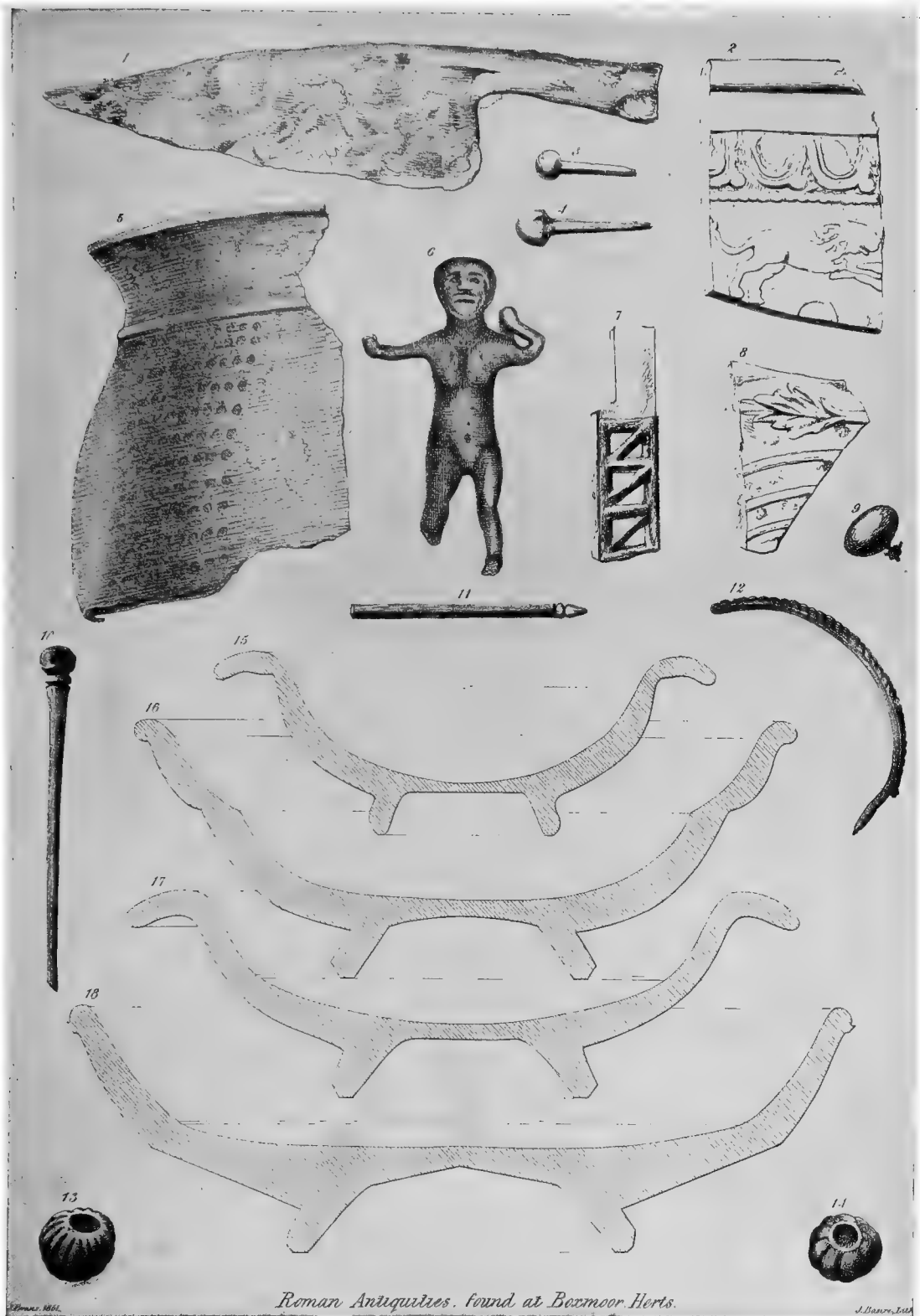

Roman Antiquities. found at Boxmoor Herts.

HEMEL HEMPSTEAD : ROMAN ANTIQUITIES FOUND IN A VILLA AT BOXMOOR

PLATE XIII

CELTIC AND ROMANO-BRITISH HERTFORDSHIRE

ings, and part of another with a different ornament and a long cylinder-shaped bead ; several bone pins ; greenish window glass $\frac{3}{8}$ in. thick, the bottom of a brown glass vessel with a bluish-white spiral pattern (Pl. xiv, no. 47), and part of a green glass rim. In pottery a Samian *mortarium*, probably Drag. shape 6 (no. 52) ; some imitation Samian, glazed, with wheel patterns, semicircles and semicircles with radial lines stamped on them, rather like Dech. ii, 327, pl. xiii, and of a late character [one shown in Walters, *Cat. of Roman Pottery in Brit. Mus.* no. M. 2475] ; the lip of a pale-red unglazed urn with indentations on it ; pieces of a large red urn about 11 in. in diameter, with its rim set back for a lid and ornamented with engine-turning, probably an ointment or other pot resembling that shown by Artis [*Durobrivae* (1828), pl. xlix, 4] ; part of a lid of an engine-turned vessel with bronze slip and coloured black inside [Walters, *Cat. of Roman Pottery in Brit. Mus.* no. M. 2733], probably the lid of a vessel similar to the last ; several other pieces in red and black, many painted in red and white [Walters, *ibid.* no. M. 2593], one on the bottom of a patera (no. 46), some with white slip in foliate and hunting patterns ; a chocolate-coloured thumbed vessel with engine-turning ; a vessel of the same colour decorated with overlapping scales [cf. Ludowici, *Römische Töpfer in Rheinzaubern*, ii, 261, fig. 72] ; light grey ware with lattice-work ; a red frilled incense cup (no. 48), a type supposed to be early ; some flat saucers of grey ware (nos. 50-1) ; three red-grey *mortaria* after the style of Drag. type 38, with white scroll pattern on the flange (nos. 53-5) ; and two stone-coloured *mortaria*, one with a thick and the other with a wide flange just below the lip (nos. 56-7). Two fragments, one red glazed black with a circular mark in the centre, and the other grey and perforated, were probably chess or draughts-men ; the horns of *ceruus elephas*, boars' tusks, oyster and mussel shells, &c. The coins from this site are not recorded separately from the others, except that 'a barbarous imitation' was found above the ornamented pavement, which would seem to show that it was still in existence, if not occupied, at the end of the period, while the pottery is of all dates, though there is nothing very early. The building appears to have fallen into ruins rather than to have been destroyed by violence ; the accumulation of flint and mortar-rubbish from the walls made it difficult to trace even the foundations. But, unless this represents only a small part of a much larger building not yet opened, it can never have been anything but a very small and poor sort of dwelling, planned, however, after the corridor type of house and furnished with ornamental pavements and frescoed walls. It is just possible that it is to be connected with building No. 2, and that both belonged to a very large courtyard type of house ; but if so, it is curious that so little of it has been hitherto found or noticed. [Sir John Evans in *Arch.* xxxv, 56, extra copies of which, with plan and additional illustrations, were published for private distribution ; notice in *MS. Min. Soc. Antiq.* xxxvii, 203 ; *Proc. Soc. Antiq.* (ser. 1), ii, 191, 295 ; *Journ. of Arch. Inst.* x, 4 ; site marked on the 6-in. O.S. Map, sheet xxxiii, S.E.]. Some of the pottery is in the British Museum.

(2) The second building, or part of it, was also opened in the same year in the station-master's garden at Boxmoor, north of the railway line and in the parish of Hemel Hempstead. It consisted of a small room with flint walls, plastered inside and coloured red. More of this building could not be traced because it extended beneath the road leading to the station and on the opposite side of it, where the ground had been raised for the railway embankment. Trial trenches were dug on the southern side of the railway line, but no trace of any building could be found here. A few yards from the foundation a rubbish pit, 14 ft. deep, was opened. Its upper part consisted of a thick black mould, its lower part of a chalky marl with layers of vegetable matter, the bottom 8 ft. being below water-level. It contained (Pl. xiii, nos. 1-14) a denarius of Nero, rev. SALVS (A.D. 54-67) ; a bronze bolt ; five small studs for leather ; part of an armilla ; an iron knife with a hollow shank and some bits of sheet iron ; parts of two handles of light green small glass vessels ; a piece of greenish glass and two light blue ribbed beads ; two bits of Samian bowls, Drag. shape 37, one with a hunting pattern on it (no. 2), a cup 2 in. high of Drag. shape 27 (no. 16) and parts of twenty cups unstamped ; a saucer 6 in. in diam. of Drag. shape 18 (no. 18) ; two bowls with turned-out rims decorated with barbotine, Drag. shape 35 (nos. 15, 17), 4 in. and 5½ in. in diameter, and five or six other barbotine vessels and much more Samian ; part of a grey urn, 5 in. diameter, ornamented with panels of rows of dark brown roundels slightly in relief (no. 5), resembling an Upchurch vase shown in Walters, *Cat. of Roman Pottery in Brit. Mus.* no. M. 2644 ; pieces of wood and stick ; the sole of a sandal 8 in. long ; a bone pin [Sir John Evans, *Arch.* xxxiv, 394, with figs. ; xxxv, 56, and more figs. in the privately published copies ; *Proc. Soc. Antiq.* (ser. 1), ii, 191]. Some of the pottery is now in the British Museum.

(3) Some burials were dug up in August and September 1837, most appropriately, in the burial ground of the Independent chapel, Box Lane, about 50 yds. due west of the first

A HISTORY OF HERTFORDSHIRE

villa at Boxmoor House. The first group of objects occurred at 3 ft. to 4 ft. below the surface, and consisted of a Roman green glass globular urn, 14 in. high, 12 in. in diameter, containing bones and small bits of gold fringe, &c., a small, narrow-necked earth jug with a handle and a bronze lamp-stand much burnt, with variously ill-shaped nails, much corroded, lying around them, as if they had held together a box or chest. The second group was 4 ft. distant and 4½ ft. deep, and consisted of a square blue-green glass bottle with reeded handle, and stamped on the bottom with two concentric circles round a figure, expanding at each end like a dice-box, and filled with bones and nails, and above them a small portion of black ashes mixed with chalk. [*Gent. Mag.* (1837), ii, 409; *Arch.* xxvii, 434, fig., xxxiv, 392; Sir J. Evans, *Boxmoor Villas* (1853), plate]. The lamp, glass bottle and bronze fragments of a box are now in the British Museum.

Lastly, the coins from both sites and the vicinity include the following :

<p>1 denarius of Pomponia or Claudia 1 „ of Nero [A.D. 54-67] 1 second brass Vespasian [A.D. 69-79] 2 „ „ Domitian [A.D. 81-96] 1 „ „ Nerva 1 first „ Hadrian [A.D. 117-38] 1 second „ „ „ „ 1 first „ Marcus 1 denarius Caracalla [A.D. 212-17] 1 first brass Severus Alexander [A.D. 222-35] 1 „ „ Maximinus [A.D. 235-8] 1 third „ Valerian [A.D. 253-61] 5 „ „ Gallienus [A.D. 253-68] 1 plated Postumus [? A.D. 259-69] 3 billon „ „ „ „ 1 third brass Victorinus [A.D. 265-8] 3 „ „ Claudius Gothicus [A.D. 268-70] 5 „ „ Tetricus I [A.D. 268-73]</p>	<p>3 third brass Tetricus II [A.D. 268-73] 2 „ „ Carausius [A.D. 286-93] 1 second „ Constantius [A.D. 305-6] 7 third „ Constantine I [A.D. 306-37] 2 „ „ Constantinopolis 1 „ „ Urbs Roma 2 „ „ Crispus [A.D. 317-26] 3 „ „ Constans [A.D. 337-50] 11 „ „ Constantius II [A.D. 337-61] 3 second „ Magnentius [A.D. 350-3] 1 third „ Valentinian [A.D. 364-75] 1 „ „ Valens [A.D. 364-78] 1 „ „ Gratian [A.D. 375-83] 1 „ „ Arcadius [A.D. 383-408] 6 „ „ barbarous—1 struck from Constantius II 11 „ „ Uncertain</p>
---	---

[Sir J. Evans, *Arch.* xxxv, 66-8].

We have thus a series of coins extending from the beginning to the end of the Roman occupation, with rather more of the third and fourth centuries than of the earlier period. This more or less agrees with the objects found. One or two of the Samian vessels and the incense cup are early, while others are late; the greater number, as far as one can tell, belong to the middle and later period.

Lastly, a small rude bronze figure of Mercury (pl. xiii, no. 6) turned up in a field on the northern side of the Bulbourne valley, and a field a little to the south-west of the town has yielded the following denarii at various times :

<p>1 Baebia (Babelon), no. 12 [B.C. 144] 1 Fonteia „ „ 9 [B.C. 88] 1 Sulpicia „ „ 6 [B.C. 69] 1 Cornelia „ „ 62 [B.C. 64] 1 Cassia „ „ 9 [B.C. 60] 1 Acilia „ „ 8 [B.C. 54] 1 Aemilia „ „ 10 „ 1 Hosidia „ „ 102 „</p>	<p>1 Junia (Babelon), no. 37 [B.C. 54] 1 Scribonia „ „ 8 „ 1 M. Antonius (Babelon), no. 113 [B.C. 31] 1 Petronia „ „ 9 [B.C. 20] 3 Augustus (Cohen), nos. 43, 47, 137 or 141 [B.C. 12] 1 Vespasian (Cohen), no. 84 [A.D. 70] 3 Vespasian (Cohen), nos. 387, 561 [A.D. 72-5]</p>
---	---

[Sir J. Evans, *Arch.* xxxiv, 397].

The sites of three other houses lie within a radius of 3 miles—at Abbots Langley to the south-west, Sarratt to the south and Latimer, co. Bucks., to the south-east.

HERTFORD.—Five Roman earthen vessels were found separately, but within a radius of 15 ft., at a depth of 3 ft., west of a house on the brow of Mangrove Hill as it slopes towards Queen's Road, in 1899-1900. They included one imitation Samian saucer, with a broad rim round the middle of it, 4 in. in diameter; two Castor vases, 4 in. and 4½ in. high, one decorated with arches in white clay, the other with raised spots; two coarse vases, one in grey, the other in red, 4 in. and 4½ in. high. In one was a 'rusty nail.' About a hundred fragments of unglazed black ware also were turned up in pulling down the Turk's Head Inn in Railway Street in May 1899. [*East Herts. Arch. Soc. Trans.* i (2), 181-4].

HEXTON.—'Quantities of gold and silver coins, principally Roman and Saxon, have been found' [Lewis, *Topog. Dict.* (1831), s.v. Hexton], perhaps thus interpreting a reference to 'coins' being found about Ravensburgh Castle and Wayting Hill (both pre-Roman earthworks) and in the barrows between there and Leagrave, co. Beds. [Salmon, *Hist. of Herts.* (1728), 170, and Camden, *Brit.* (ed. Gough 1789), i, 342].

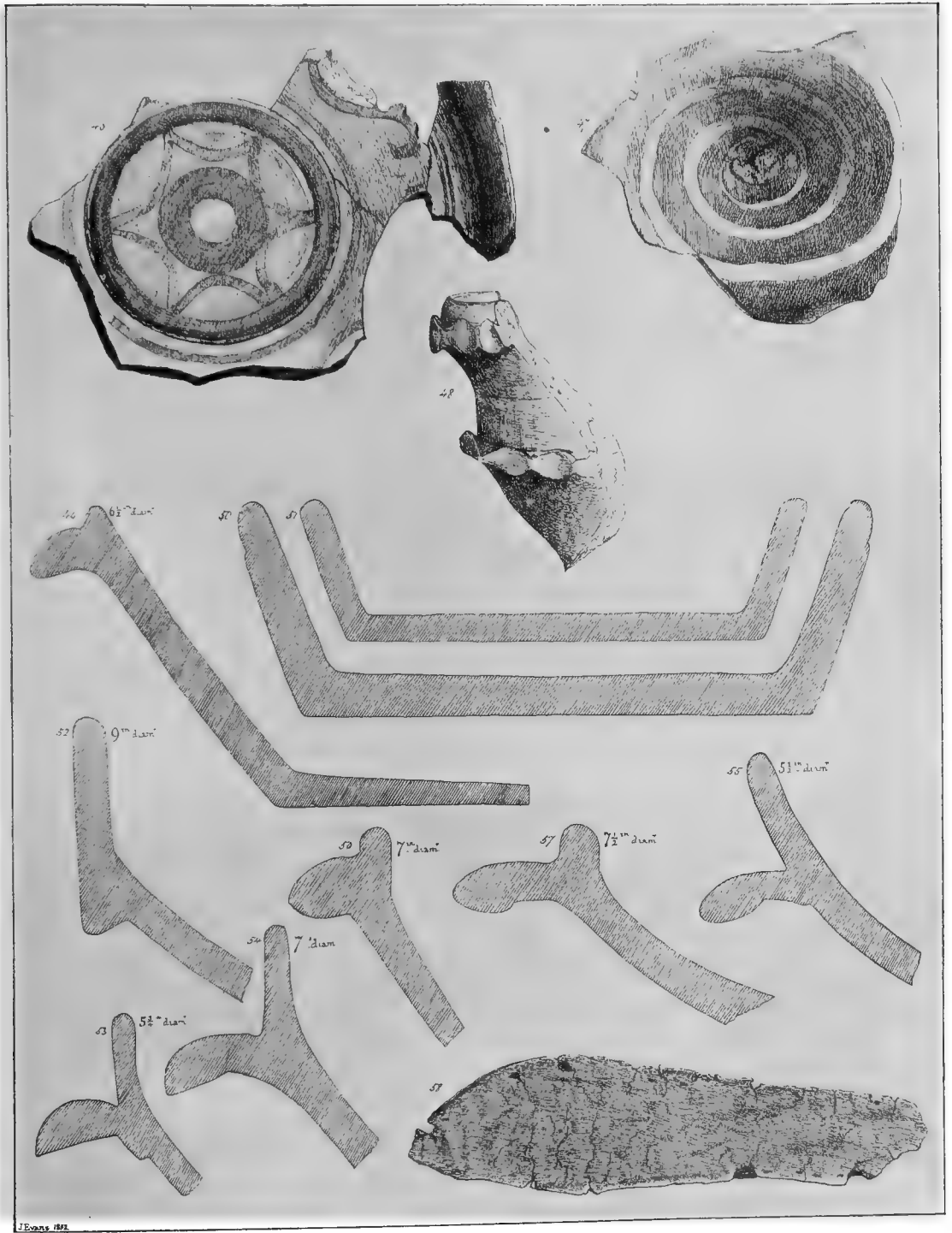

HEMEL HEMPSTEAD. ROMAN ANTIQUITIES FOUND IN A VILLA AT BOXMOR
 PLATE XIV

CELTIC AND ROMANO-BRITISH HERTFORDSHIRE

HINXWORTH.—Some Roman burials were dug up in a gravel-pit between Caldecote and Hinxworth in 1723-4. They consisted of large urns full of burnt bones, and near them large and small urns, Samian paterae, one or more stamped ampullae, glass lachrymatories, handle and neck of *simpulum* and green glass beads, bronze *fibulae*, 'two long glass beads,' a 'stone sword handle.' Near them skeletons had been buried 1 ft. beneath the surface with head to the south-east [Stukeley, *Itin. Curios.* (1724), 74, hence Salmon, *Hist. of Herts.* (1728), 339; Lewis, *Topog. Dict.* (1831), s.v. Hinxworth. Some shown to Soc. Antiq.; see MS. Minutes, 8 May 1723; 10 March 1724-5, hence Camden's *Brit.* (ed. Gough 1789), i, 342; Brayley and Britton, *Beauties of Engl. and Wales* (1808), vii, 176; Clutterbuck, *Hist. of Herts.* (1815-27), iii, 523]. Cussans, *Hist. of Herts. Odsey Hund.* 23 probably refers to the same find when he mentions 'coins found in Caldecote Field adjoining Hinxworth parish.' See also Ashwell.

HITCHIN.—A variety of finds have been made at Hitchin and in the immediate neighbourhood. (1) A Roman kiln is said to have been discovered beneath accumulated rubbish in an old brickfield on Hitchin Hill, near Stevenage Road, about a quarter of a mile south of the town [Cussans, *Hist. of Herts. Hitchin Hund.* 5, 6]. (2) Several skeletons, one nearly 7 ft. long and another with traces of an iron weapon with it, and west of them a great number of cinerary urns, lying in a curved line east and west, and around them many pieces of Samian ware, a bronze armband and ornaments, knives, &c., a silver denarius of Septimius Severus (A.D. 193-211), small base metal coin of Julia Domna (A.D. 193-211), and small brass of Allectus (A.D. 293) and Constantine II (A.D. 337-40), were dug up 2 ft. below the surface in the kitchen garden of Foxholes, Tilehouse Street, a mile west of Hitchin [Cussans, *Hist. of Herts. Addenda to Hitchin Hund.* 317; Seebohm, *English Village Community* (1884), 430; Ransom, *Herts. Nat. Hist. Soc. Trans.* (1886), iv, 47; *Journ. Arch. Inst.* xxxix, 426, probably refers to this find]. (3) Many Roman urns containing burnt bones and several Samian paterae, coins of Septimius Severus (A.D. 193-211), Gallienus (A.D. 253-68), Tetricus (A.D. 268-73), Diocletian (A.D. 284-305), Maximian (A.D. 286-308), Carausius (A.D. 286-93), Allectus (A.D. 293) and Constantine (A.D. 306-37), were found in drainage works at the sewage farm, Bury Mead, a mile north of Hitchin, shortly before 1881 [Cussans and Ransom as above]. (4) Two burial urns came from Taylor's Hill [Cussans, *op. cit. Hitchin Hund.* 5, 6]. (5) Small coins of the Lower Empire near Wellhead, Charlton, and many Roman coins and potsherds have been found in the neighbourhood of Hitchin. In the Hertford Museum is a biscuit-coloured urn, 5 in. high, from here [Inform. from Mr. Bullen and the same references]. Cussans [*op. cit. Hitchin Hund.* (1874), 33] also mentions a carved white marble stone, part of a frieze representing a triumphal procession, found built into the walls of the Red Lion Inn when it was pulled down for the site of the Corn Exchange in 1852. It was thought to have come from a dwelling-house in the neighbourhood—perhaps Wymondley—but it might just as easily have been brought from abroad at some time. The house at Wymondley lies only $1\frac{1}{2}$ miles east and the cemetery 2 miles south-east. For Wilbury Hill, see Norton and the find of Late Celtic urns near there, probably in Walsworth parish [*V.C.H. Herts.* i, 236], and the cemeteries at Danesfield and Pegsdown, see Pirton. Cf. also Willian and Ickleford.

HODDESDON.—Some Upchurch urns were dug up in a gravel-pit in Paul's Lane, about $1\frac{1}{2}$ miles east of Ermine Street, in the early part of 1862. One of them—an olla—was 5 in. high, of grey earth and scored with two bands of ornament in trellis-work and diagonal dots, and another urn-shaped vessel with wide mouth and bulging side. More were discovered in 1873 in the centre of a gently rising mound a quarter of a mile from the above, and in 1874, at 2 ft. from the surface, a trench 8 ft. long, cut east and west and containing a number of cinerary urns, was opened in laying out a new road (now called Roman Road) from Barford Street to the Ware Valley, just above Woollens Brook. With them was an iron spear-head about 9 in. long, and near by many animal bones and two Roman coins [*Journ. Brit. Arch. Assoc.* xviii, 268, 369; Cussans, *Hist. of Herts. Hertford Hund.* (1876), 173; the *Times*, 18 August 1874; *Herts. Mercury*, 5 April 1902]. Most of these objects are preserved in the room of the Hoddesdon Mutual Improvement Society. A plain *fibula* was found in January 1901 in some excavations made in Roman Street, and in July 1899 'a stone-paved trackway' 4 ft. below the surface of Ware Road, which was considered Roman partly because three odd horse-shoes thought to be Roman were found near it. In January 1901 also an 'inverted tile,' said to have been stamped 'LE.IX,' was turned up in Hoddesdon, the precise site not being given [*East Herts. Arch. Soc. Trans.* i (3), 363, (2), 187], but on further examination it was discovered that the tile was modern and bore the stamp of a local tilemaker. A cinerary urn 9 in. high and 12 in. in diameter, decorated with six horizontal lines in two groups, and containing calcined bones, was found with pieces of two other vessels in a sand-pit in West Hill Field, near the Hertford Road and west of Hoddesdon [*ibid.* i (2), 184]. Lastly a bronze coin of Pius (Cos. III) [A.D. 138-61] with reverse 'Britannia' was discovered

A HISTORY OF HERTFORDSHIRE

in May 1899 near Rye House station, three-quarters of a mile north-east of Hoddesdon [*ibid.* i (2), 186].

The numerous small finds suggest that a building may some day turn up at Hoddesdon, perhaps even a pottery kiln.

HORMEAD, LITTLE.—There seems no reason for assigning a Roman date to the granite stone mentioned by Salmon as standing near the junction of Stonecross Lane and Ware Road, near Hare Street, and in 1900 among some nettles inside a field by a broken-down gateway at the top of the hill exactly opposite Little Hormead Church [Salmon, *Hist. of Herts.* (1728), 312, hence Clutterbuck, *Hist. of Herts.* (1815–27), iii, 423; *Herts. Mercury*, 13 Oct., 10 Nov. 1900].

ICKLEFORD.—Roman coins are frequently found here and at West Mill on the R. Oughton (in Pirton) [*Arch.* liii, 257]. Some pottery is said to have been found here some few years ago, but no precise site is given. A black urn 3½ in. high, decorated with two incised lines round the shoulder and below the rim, is now in the Hertford Museum [Inform. from Mr. Bullen].

KELSHALL.—‘A large quantity of Roman pottery, cinerary urns, Samian ware, &c.’ was found among some gravel a foot below the surface, with two skeletons, in 1877–8 [*Herts. Mercury*, 6 Sept. 1902]. Burials here occurred in the chalk further to the north-east near Therfield and Royston (q.v.).

KIMPTON.—A hoard of 230 silver republican and imperial coins had been deposited in a dark-coloured urn and were found in May 1851 in widening a road in Prior’s Wood a quarter of a mile west of St. Lawrence’s Church, Ayot, but in the parish of Kimpton. The majority of them were in a fair condition; twenty of them have been described by Sir John Evans as follows :

1 Valeria (Babelon), no. 11 [B.C. 104]	1 Julia (Babelon), no. 10 [c. B.C. 50]
1 Cipia „ „ 1 [B.C. 94]	1 Cordia „ „ 1 [B.C. 49]
1 Coelia „ „ 2 [B.C. 94]	1 Accoleia „ „ 1 [B.C. 43]
1 Vibia „ „ 1–5 [B.C. 90]	1 Antonia „ „ 125 [B.C. 31]
1 Calpurnia „ „ 11 [B.C. 89]	6 Augustus (Cohen), no. 64–5, 21–3, 42–3
2 Fonteia „ „ 11 [B.C. 88]	[B.C. 2]
1 Furia „ „ 23 [B.C. 53]	2 Tiberius „ „ no. 16 [B.C. 2–A.D. 35]

[*Numis. Chron.* (1851–2), xiv, 83; *Journ. Brit. Arch. Assoc.* (1852), vii, 176].

KNEBWORTH.—The barrow here when opened was found to contain no urns and only a few bones and was full of flints [*Journ. Brit. Arch. Assoc.* xxvi, 260].

LETCHWORTH.—Various finds, chiefly of burials, have been made in laying out and draining the Garden City. ‘A quantity of pottery,’ thought to be Roman, was found near some post-Roman burials on Norton Common in 1905 and ‘a burial vase’ in excavating for a gasometer the same year [*Herts. Express*, 25 Mar. 1905]. More were noted in 1910 in Letchworth Lane and seem to consist of burial urns about 2 ft. below the surface. Animal bones also occurred here and near the ‘Pix’ [*The Citizen*, Letchworth, 3 Dec. 1910]. The record of these finds is so scanty that it is not even certain they are Roman. For other Roman finds in the neighbourhood, see Norton, Baldock, Willian and Ickleford.

MARKYATE STREET.—See Caddington.

MUNDEN.—See Watford.

NORTHCHURCH.—A bronze helmet was found in excavations for the Grand Junction Canal near Northcott Hill in 1813 and is now in the British Museum (pl. i). It is almost circular (measuring internally about 8 in. by 7½ in.), has a plate for the neck or neckpiece about 2½ in. at its widest, with a rivet for a strap underneath to hang it up, and a circular knob about 1 in. high on the top where the crest should come; inside on the left a plate had been fastened with two rivets and turned up on to the rim, on the right a hook also fastened with a rivet, both doubtless belonging to some arrangement for keeping the helmet on the head. Some helmets resembling it are shown by Lindenschmidt in *Das Römisch-Germanische Central Museum* (1889), Taf. xxvii, 7, and also in Daremberg and Saglio, but they all have a piece cut out to allow room for the ear and some have a cheekpiece, while the Northchurch example, which is small in the head, is quite straight round and probably cleared the ears. Sir Augustus Franks suggests that it is early Roman or Gaulish, and Sir John Evans considered it possibly Late Celtic, but the drawing of it does not confirm this view. There seems to be no reason why it should be called ‘Late Celtic,’ and it may possibly be Roman. Mr. ffoulkes suggests that had it been of iron it might be dated at about 1640, but being bronze it is probably Roman. [Drawing published by the Soc. of Antiquaries, 1819, *Vetusta Monum.* (1835), v, plates xxvi, xxvii; Lewis, *Top. Dict.* s.v. Tring; Franks, *Proc. Soc. Antiq.* v, 362; Sir J. Evans, *V.C.H. Herts.* i, 236, where also he states that the *provenance* of a similar helmet



RADLETT : POTTERY FROM ROMANO-BRITISH KILN ($\frac{1}{3}$)

CELTIC AND ROMANO-BRITISH HERTFORDSHIRE

was Hitchin and not St. Albans, as other writers assert]. Roman *fibulae* and British coins have been found near the Cow Roast Inn at the bottom of Northcott Hill, and are marked on the 6-in. O.S. Map, sheet no. xxv, S.E., east of the canal and a quarter of a mile east of the Cow Roast Inn in this parish, and therefore probably near the helmet [*Arch.* liii, 262, s.v. Wigginton]. See also Wigginton and Aldbury for the coins on Moneybury Hill, 2 miles north.

NORTON.—A silver coin of Faustina II, Cohen type 190 (A.D. 161–80), was found on the earthwork at Wilbury Hill, and near the same place human bones and three coins of Constantius (A.D. 305–6) in 1806, while ‘a great variety of coins of the Roman emperors have turned up . . . of late years in the adjacent lands’ [Clutterbuck, as below]. According to another authority, coins from Julius to Constans (A.D. 337–50) still occur here [Salmon, *Hist. of Herts.* (1728), 160, hence Brayley and Britton, *Beauties of Engl. and Wales*, vii, 176; and Camden, *Brit.* (ed. Gough, 1789), i, 342; Reynolds, *Itin. Antonini* (1799), 472; Clutterbuck, *Hist. of Herts.* (1827), iii, 13 n., hence Cussans, *Hist. of Herts. Odsey Hund.* (1873), 74]. A small Roman bronze figure 3 in. high was found close to Wilbury Hill at the intersection of Icknield Way and a road that runs south-east [Cussans, op. cit. *Hitchin Hund.* (1874), 5]. Roman interments have been found half a mile west of Wilbury Hill [*Arch.* liiii, 257, s.v. Hitchin]. For an account of the earthwork, see *East Herts. Arch. Soc.* ii (3), 279; *V.C.H. Herts.* ii, 111; and the Late Celtic Cemetery, *ibid.* i, 236. See also Hitchin, Willian and Letchworth.

PENLOWE PARK.—‘Much Samian ware, urns, &c.’ were dug up in ‘Penlowe Park, Herts.’ June 1845, and are described by Mr. Inskip of Shefford (co. Beds.). ‘Penlowe Park’ is perhaps a mistake for Henlow Park, between Shefford and Astwick, Bedfordshire, or Pendley Park in Tring parish. The Samian included a ‘vase’ ‘of diminutive size’ (perhaps Drag. shape 67), decorated with medallions (stags browsing), and two dishes, one with graffiti scratched on the bottom [*Journ. Brit. Arch. Assoc.* (1845), i, 340].

PIRTON.—(1) A large number of burials were found in 1835 close to the surface in a field called Dane’s Shot on Pirton Hill, half a mile from Icknield Street. Some thirty skeletons lay in two rows, one of which was carefully arranged, the skeletons lying 1½ yds. apart, with heads to the north-east, the other carelessly, three or four being thrown into one grave. With them were many ‘dull black’ urns of moderate size containing bones, and also a ‘curiously ornamented’ brass armet, some buckles and twisted pins. [*Gent. Mag.* (1835), i, 305; Cussans, *Hist. of Herts. Hitchin Hund.* 15, quoting *County Press*, 14 February 1835]. Ransom [*Herts. Nat. Hist. Soc. Trans.* (1886), iv, 40] adds that forty-five years previously a large number of skeletons, and also those of horses with several fragments of iron and bronze, were found here, which he concludes were post-Roman burials. But if he refers to the same find the contemporary accounts do not mention horses, and the burials as described in them might as well be Roman as Saxon. Mr. Ransom also records an amphora, 3 ft. high, dug out at a short distance, and ‘a variety of other vessels have since been found there.’ (2) We may also include here another cemetery in the adjoining parish of Pegsdown in the county of Bedford. It lay at the foot of the chalk downs on Pegsdown Common, half a mile from Icknield Street and about four miles from Hitchin. It was opened in 1879 by Mr. Ransom and found to contain ‘a considerable number of broken urns of brown pottery’ with cremated human bones in some of them, and several pieces of Samian. Beneath them an earlier cemetery was revealed, containing ruder and hand-made urns, ¾ in. thick, with human ashes mixed with charcoal and iron nails in them. [Ransom, *Herts. Nat. Hist. Soc. Trans.* (1886), iv, 39]. See also Hitchin, Ickleford and Norton.

RADLETT.—Two kilns were found in the autumn of 1898 on the property of Sir Walter Phillimore in a sand-pit on the east side of Loom Lane in this parish. The first was much destroyed before its nature or date was realized, but it was circular, about 3 ft. in diameter, with walls about 5 in. thick, made of baked clay with bits of brick irregularly inserted. The floor of the flue, about 2 ft. below the original ground level, consisted of the natural sand burnt red for an inch or more. A projection was traced, extending from the wall of the kiln to the middle of the flue, where it formed a pedestal 9 in. high to support the kiln floor, of which nothing remained.

The second kiln, lying 10 ft. south-east, was also excavated and planned. The remains lay 3½ ft. below the present surface; it was of horseshoe shape, its greatest length being 6 ft. and width 5 ft. 1 in. measured internally. It had been made by digging a hole 4 ft. deep in the sand, against which had been built a wall 6 in. thick of brickbats set in clay, and afterwards baked. It was heated from a furnace 3 ft. 9 in. long and 1 ft. 7 in. wide, connected with a flue which ran all round the kiln, and was constructed by filling in the centre of the kiln with a block or pedestal of masonry, 1 ft. 9 in. high, which also served to support the oven floor, about 7 in. thick, made of clinkers and burnt clay covered with a layer of sand. The flue was covered by a flat arch. The kiln, when deserted, was evidently full of pots,

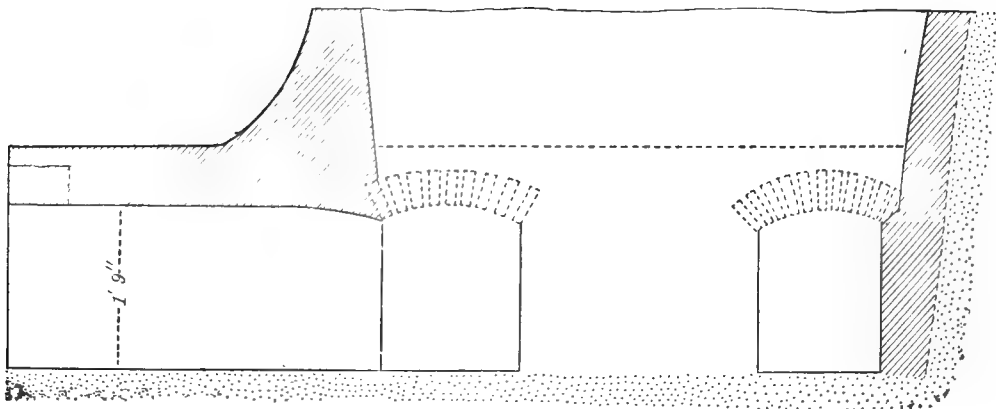
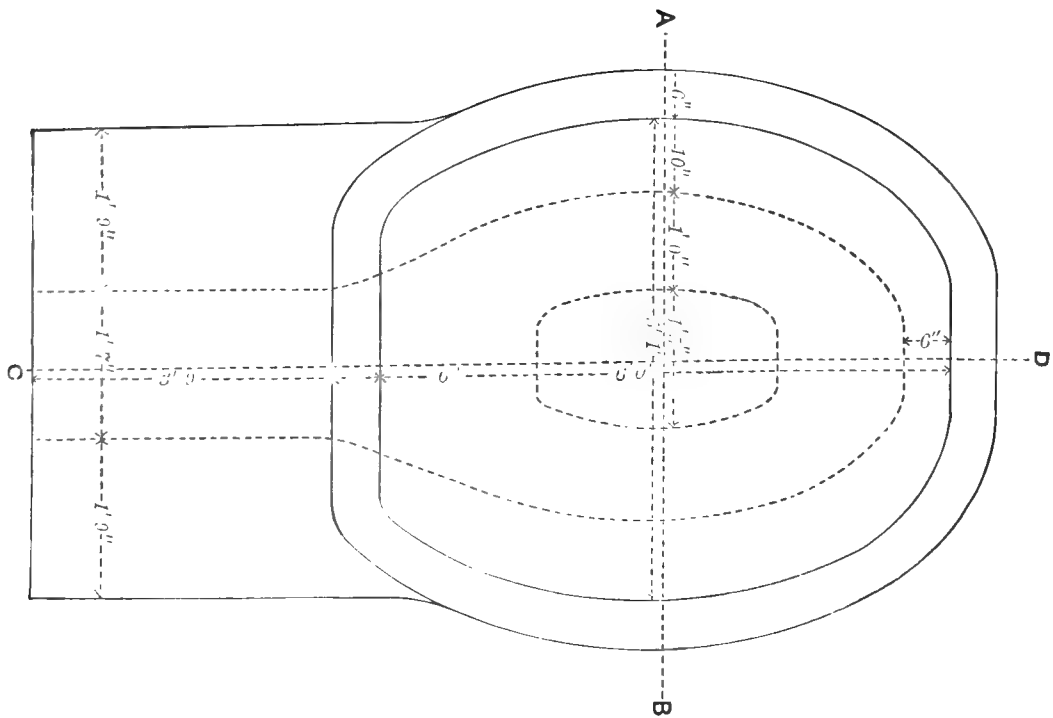

SECTION AT C-D

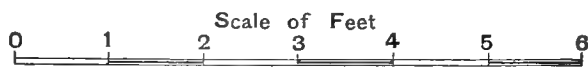

PLAN AND SECTION OF ROMAN POTTER'S KILN FOUND AT RADLETT (No. 2)

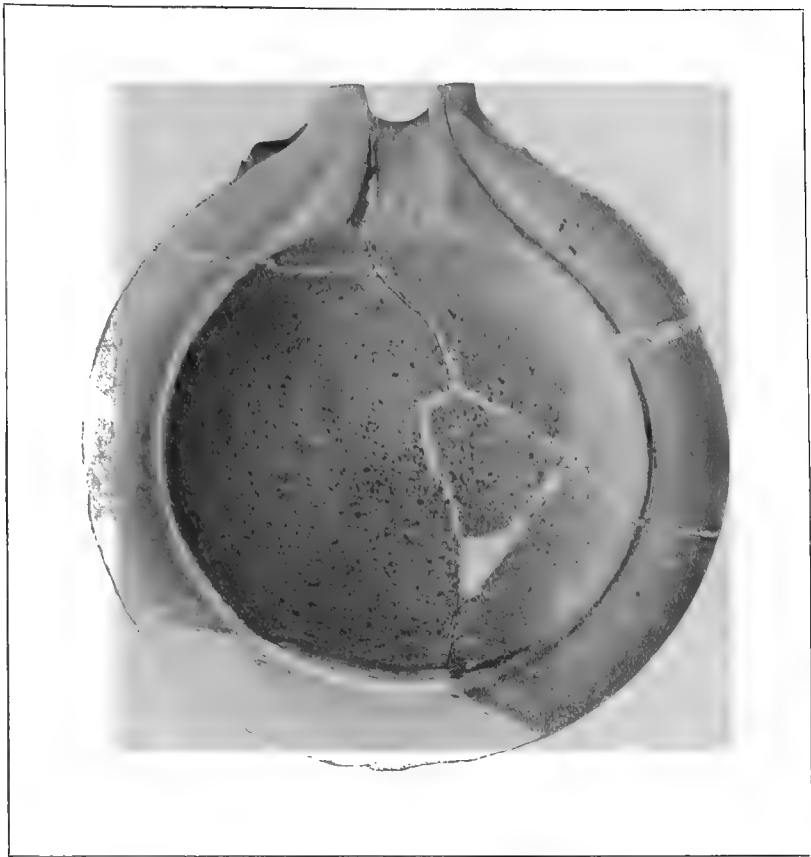

RADLETT : MORTARIUM FROM KILN ($\frac{1}{4}$)

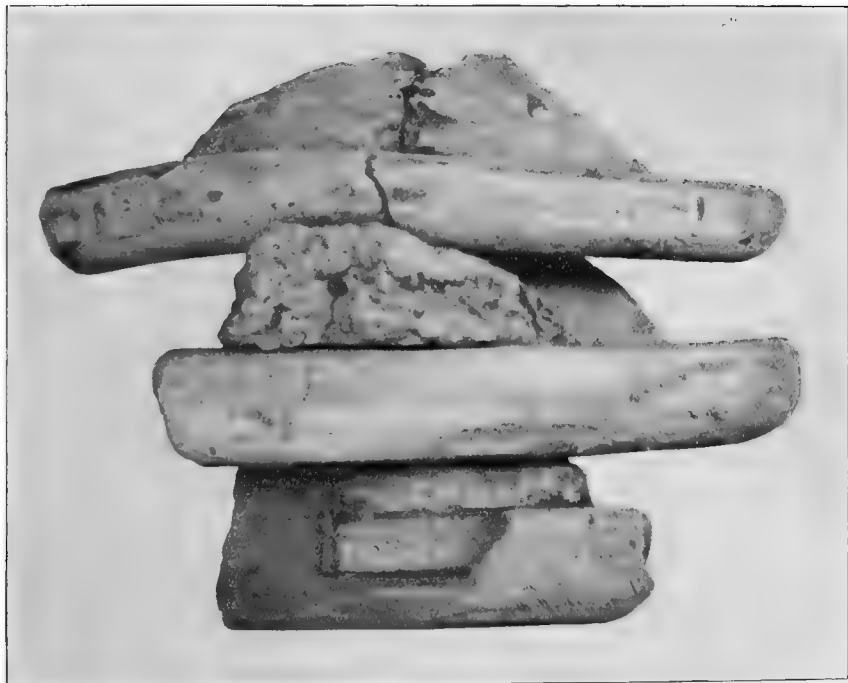

RADLETT · FRAGMENTS OF MORTARIA SHOWING METHOD OF PACKING IN KILNS ($\frac{1}{2}$)

CELTIC AND ROMANO-BRITISH HERTFORDSHIRE

which had been destroyed by the fall of the dome of the oven, but the furnace had been damped down by covering the mouth with puddled clay which still remains. Roman ovens of circular shape with floors supported in a similar fashion to that of the Radlett kiln have been found at Castor (Northants.), Shoebury (Essex) and under St. Paul's Cathedral (London). The pots found in the kilns were mostly whitish-red coarse *mortaria*, but also included jug-shaped amphorae, urn-shaped pots and perhaps their covers and various forms of paterae (Pl. xv, xvi), some of these having sand mixed with the clay, which gave them a bright appearance. Twenty-two of the *mortaria* were stamped on the rim 'CASTVS,' 'CASTVS FECIT' or 'FECIT CASTVS.'

On one was 'ALBINVS' and on two 'FECIT' spelt backwards, and four bore illegible inscriptions. The name 'Castus' has not been found on *mortaria* before, but there was a potter of that name at La Graufesenque in Gaul (and maker of form 29), and this name also occurs at Rheinzabern. But many *mortaria* have been found stamped 'Albinus,' and some showing there was a Lyons potter of that name. It is also said to have been found on La Graufesenque plain saucers and on some from Rheinzabern. It is evident that the potter to whom the kiln belonged was called Castus. Perhaps the 'Albinus' *mortarium* had been imported from Gaul to be used as a model. [Account by Mr. Page the excavator in *St. Albans and Herts. Arch. and Archit. Soc. Trans.* (New Ser. 1899-1900), i, 176-84, with plans, hence *Journ. of Arch. Inst.* lviii, 95, and *Proc. Soc. Antiq.* xvii, 261]. For the potters see Walters, *Cat. of Roman Pottery in the Brit. Mus.* (1908), no. M. 124, 609, 978 (Castus) pp. liv, 428; *Cat. of Guildhall Mus.* (1903), 103, 104 (Albinus); Déchelette, *Les vases céramiques ornés* (1904), i, 81-2; Ludowici, *Römischer Töpfer, Stempel-Namen, and Stempel-Bilder in Rheinzabern* (1901-8). See also the last volume, pp. 151-64, *Artis, Durobrivae* (1828), *Proc. Soc. Antiq.* xvi, 42, for ovens.

ROYSTON.—Stukeley mentions Roman coins from here and states in one place that 'this very year (1724) they found Roman coins near there,' and describes one of brass plated over silver of Agrippina and Nero (A.D. 54-9), Cohen no. 7, but this does not seem sufficient evidence for the site of a Roman town, as he supposed, at the crossing of the two roads, Icknield Street, which just here has a Roman appearance, and the road from Colchester to Sandy in Bedfordshire [Stukeley, *Itin. Curios.* (1724), i, 76; and *Palæographia Britannica*, no. 1, p. 2; hence Reynolds, *Itin. Antonini* (1799), 460, &c.]. The bust of a Roman lady in bronze, 3 in. high, with hair dressed in the style of the 3rd century, was found at Royston [*Antiq.* xvii, 270]. Two brass coins of Pius (A.D. 138-61) and Verus (A.D. 161-9) were turned up in ploughing at Long Field, Tadlow (co. Cambs.), early in 1907 [*Ibid.* iii (New Ser. App. 1907), 126; *Daily News*, 27 Feb. 1907]. A small green glass bottle with two reeded handles, 5 in. high, but

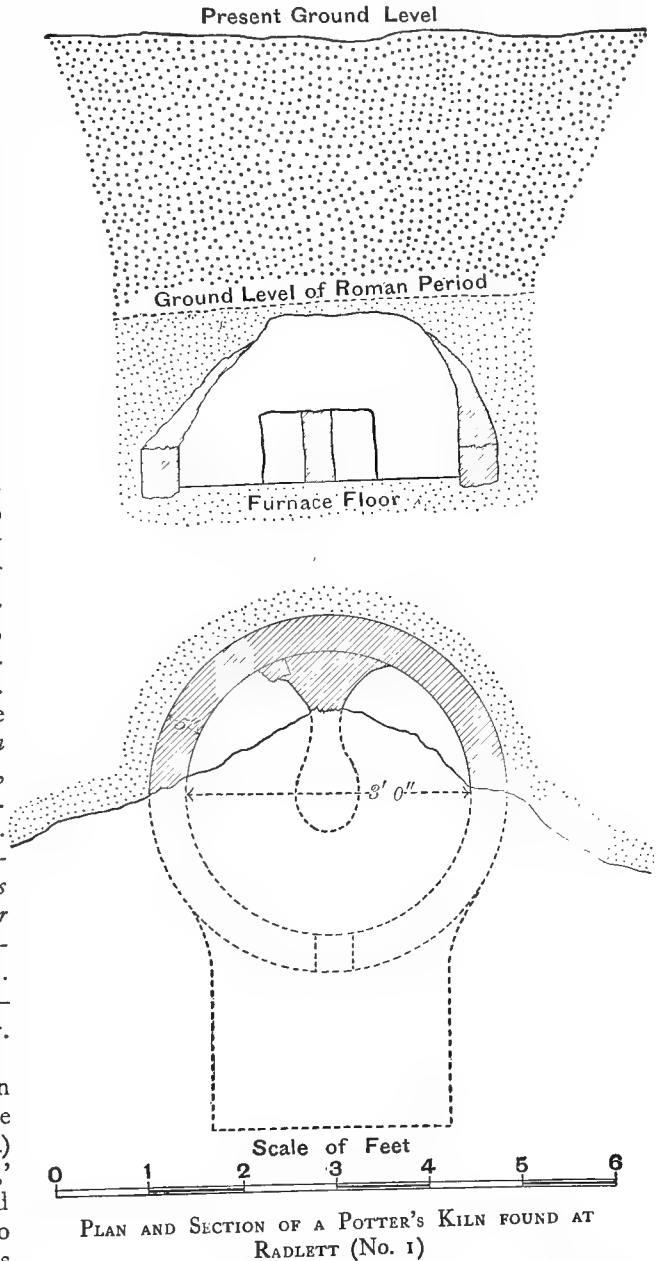

PLAN AND SECTION OF A POTTER'S KILN FOUND AT RADLETT (No. 1)

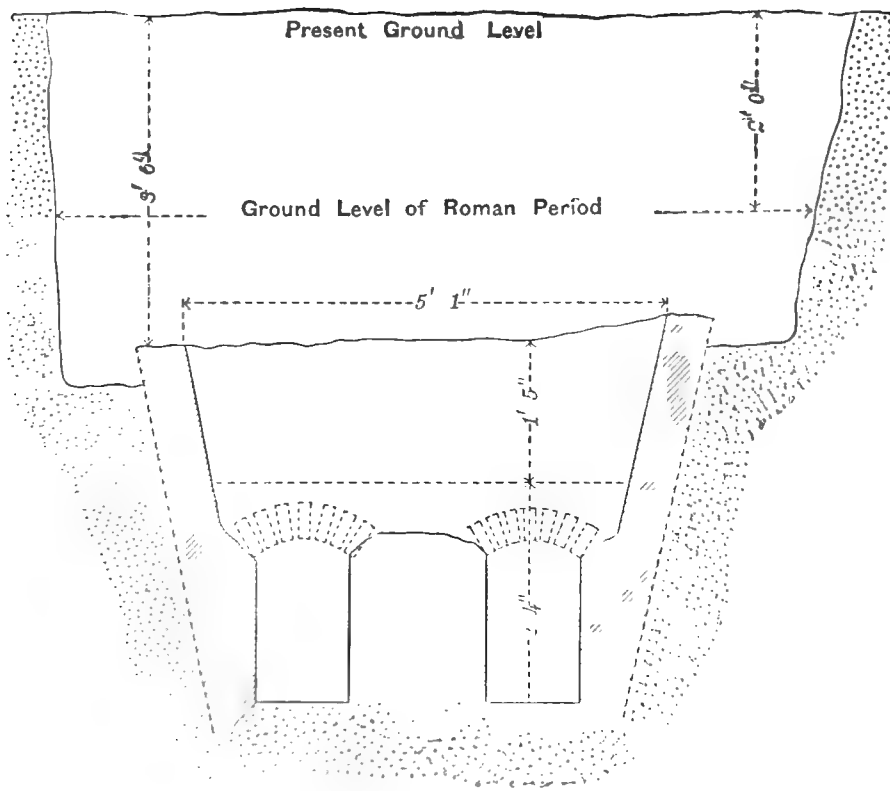

SECTION AT A-B

Scale of Feet



ROMAN POTTER'S KILN FOUND AT RADLETT



POTTER'S STAMPS OF CASTUS FOUND IN A KILN AT RADLETT

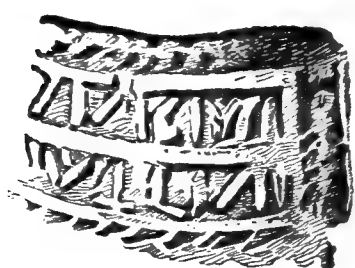

POTTER'S MARKS FOUND IN A KILN AT RADLETT

CELTIC AND ROMANO-BRITISH HERTFORDSHIRE

broken at the neck, is supposed to have been found at Royston and is now in the Hertford Museum [Inform. from Mr. Bullen]. Some of the barrows in the neighbourhood—especially on Royston Heath, west of the town—have yielded Roman coins and pottery, but for these see Therfield and Kelshall. The really important finds occur over the Cambridgeshire border, but only a mile or two away, at Litlington (villa and cemetery) and Limloe Hill (cemetery). No evidence of Roman occupation has been found in the cave here.

RUSHDEN.—Mr. Seebohm records Roman coins from Cumberlow Green [*English Village Community* (1884), 434].

ST. ALBANS.—See p. 125.

SARRATT.—Foundations of a building were excavated in October 1907 in a field called Church Field, 200 ft. north of Sarratt Bottom Farm, which slopes southwards from Rosehall Wood to the River Chess. The building was rectangular in plan and measured 48 ft. from east to west and 33 ft. from north to south. It had an apse, 17 ft. across the chord, added on to the west end and built not quite in the centre of the wall, the two rooms being connected by a gap 9 ft. or 10 ft. wide in the separating wall. The east wall of the rectangular room ran further south, but the end of it was not found. In this wall traces of a post were observed, which the excavators thought might possibly be the last of a row. The walls were $2\frac{1}{2}$ ft. thick, lay 9 in. below the surface and extended 3 ft. deep into the ground. They were built of flint and pure lime cement that was quite soft and wet. Some plaster still remained on the inside of the walls. Many bricks, flue tiles, pottery and glass lay about and two illegible coins were found. More buildings exist further north up the hill, but they have not been opened. The upper part of the tower of Holy Cross Church, nearly half a mile south-east of the farm, is almost entirely built with Roman bricks and tiles, and many tiles and pieces of rough conglomerate (plum-pudding stone) occur in the lower part of the walls, probably from the Roman building. Fragments of urns frequently turn up in the churchyard, and an iron key and bronze *fibula* were found there before 1881, also a large heavy brass ring about 1840.

A building of somewhat similar plan, but with a square, instead of a circular, inclosure at the end, was found at Castlefield, near Andover (Hants). It had, in addition, two rows of bases for pillars running down the centre, and two open hearths and three sunk furnaces within it. More elaborate

buildings of the same type have been opened at Clanville (in Weyhill), Thrupton and Holbury (in Lockerley) in Hants, at Hartlip in Kent and Ickleton in Cambridgeshire, and elsewhere, and are all evidently examples of a primitive type of Romano-British house, which resemble neither the Celtic hut nor the Italian house, nor even the corridor houses of Britain and North Gaul. This building at Sarratt, as that at Clanville, may possibly be connected with others further north by a courtyard, all forming part of one house of a type known as the 'courtyard.' [For these see *V.C.H. Hants*, i, 302, and references there given; inform. from Mr. A. Whitford Anderson; *Estates Gazette*, 2 Jan. 1909; and *St. Albans Arch. and Archit. Soc. Trans.* Jan. 1909, with plan; Cussans, *Hist. of Herts. Cashio Hund.* 111]. Another dwelling-house near Latimer lies 2 miles west and further up the valley, but in the county of Buckinghamshire, and another at Abbots Langley in the Gade Valley, 4 miles north-east.

SAWBRIDGEWORTH.—'Roman pottery has been found in considerable quantity' on Stonards Farm, about half a mile east of the stream called Fiddler's Brook and 2 miles west of Sawbridgeworth [*Journ. Brit. Arch. Assoc.* (1888), xlv, 116]. Two urn burials were found in March 1908 near the River Stort, in a wood called Ashplant, 170 yds. east of the Harlow Road, but within Pishobury Park. They were deposited 6 ft. below the surface on a layer of ashes 3 in. thick, were 2 ft. apart and contained calcined bones and ashes. Each stood on a saucer, and over the mouth of one was a small inverted cup, apparently Samian, 2 in. high and 4 in. in diameter at the top, with a rose-shaped potter's mark stamped on the bottom. One of the urns was of hard, dark grey ware, the other of buff colour, decorated with a small indented pattern; there was also part of a small brown jug or vase, stained black on the outside and decorated with two parallel lines [*Glasscock, East Herts. Arch. Soc. Trans.* i. (2), 191]. Cf. Widford.

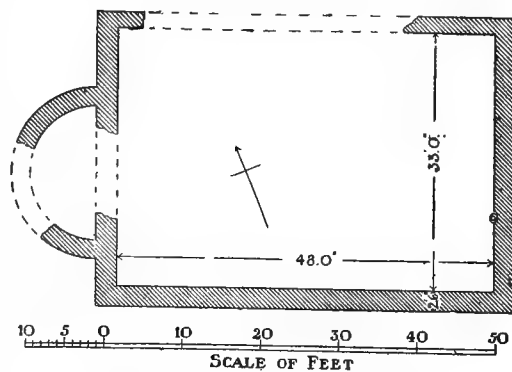

PLAN OF ROMAN BUILDING AT SARRATT

A HISTORY OF HERTFORDSHIRE

STANDON.—A tessellated pavement 12 ft. 9 in. square, with a plain square design in black, white and red, was found in 1756 at Thundridge. This is described in 1827 as lying near to two barrows in a field called Hilly Field at Haven End. These lie just outside and east of the shrubbery of Youngsbury in Standon parish, on a hill above the River Rib, on the opposite and southern bank of which stands Thundridge Church, and about half a mile east of Ermine Street. The same authority adds that ‘no part of this pavement is now visible, yet many of the *tesserae* of which it was composed may still be picked up in the shrubbery at Youngsbury, where it was situated; and within the last fifty years there were in existence parts of it which had not been disturbed, and were apparently perfect.’ Nothing of the villa now remains above ground. Part of the villa site was excavated about 1890 by the late Mr. Charles Giles Puller, and foundations of walls and a circular pit were found, together with a bone pin and many *tesserae*. In 1905 a rubbish pit containing charcoal, animal bones and potsherds was found by Mr. F. C. Puller about 70 yds. south-west of the villa site [Inform. from Mr. F. C. Puller]. The more eastern of the barrows was opened about 1788 and was said to contain spear-heads, coins and pottery thought to be Roman. The other was excavated in June 1889 by Sir John Evans. It was about 12 ft. high, with a diameter of about 60 ft., and was constructed with layers of local gravelly subsoil mixed in places with a heavier clay soil. At the bottom of it a cavity 3½ ft. long and 3 ft. wide was found about 8 ft. below the apex of the mound; it was roofed with hard and stiff clay soil, and had evidently contained a wood cist 3 ft. long and 1 ft. 11½ in. wide, with a lid attached by four rough hinges. In this had been deposited a well-burnt grey urn 17½ in. high, 8½ in. in diameter at the mouth with a rim nearly 1 in. deep [somewhat resembling plate xlix(a), fig. 5, of Curle, *A Roman Frontier Post* (1912)], ornamented with transverse markings round the body and curved lines round the neck, and containing much charcoal and calcined bones and nearly 200 nails; a small, wide jug-shaped vessel of light-coloured ware, 6½ in. high; a large square glass bottle 15 in. high, with a thick lip and flat reeded handle, stamped on the bottom with a kind of star pattern in the centre and the segment of a circle in each corner (the same as that on the Harpenden bottle), and nearly full of burnt bones and a little resinous matter, probably incense; some large iron nails, probably part of the wood chest. Some bones of a roe-deer were found mixed with some of the human bones. Sir John Evans dated the burial to the latter half of the 2nd century. [MS. note in a copy of Chauncy, *Hist. of Herts.* (1700), 213, once the property of Mr. George North, vicar of Codicote, and now in the Bodleian Library (Gough, *Herts.* 19), hence Clutterbuck, *Hist. of Herts.* (1827), iii, 277, but misquoting the date of the find, and hence Cussans, *Hist. of Herts. Braughing Hund.* (1870), 164; *Arch.* lii, 287, plate vi for the barrows. Braughing lies about 5 miles north-east].

STANSTEAD ABBOTS.—The site of the villa mentioned in *Arch.* liii, 261, as found here is really in the parish of Stansted Mountfitchet, Essex, on the eastern bank of the River Lea and about 12 miles north-east of Stanstead Abbots. Roman bricks are said to occur in the tower and the north wall of the nave of Stanstead Abbots Church, where they are placed in herring-bone fashion, and Roman pottery in the churchyard [MS. note in a copy of Salmon's *Hist. of Herts.* 250, now in the Bodleian Library (Gough, *Herts.* 18); *East Herts. Arch. Soc. Trans.* ii (1), 28]. Roman remains have been found in the neighbourhood at Ware, Hoddesdon and Amwell (q.v.).

THERFIELD.—Gough mentions a ‘Roman camp, a quarter of a mile from Royston, on the road to Baldock,’ of which a drawing was shown to the Society of Antiquaries in 1744. Cussans also states that ‘from the number of coins and other remains found’ in a valley west of the road joining Therfield and the Baldock Road, it ‘seems to have been the site of a Roman camp, but all traces, if such existed, have been destroyed by the plough.’ Stukeley also mentions earthworks here, but gives no reason why they should be considered Roman. Cussans refers to a barrow being opened near the ‘Thrift’ in 1833, which was said to contain Roman pottery, but that may possibly be the barrow at Limloe Hill, Cambridgeshire, which was excavated that year. Other barrows on Royston Heath have been cut through, but their contents do not seem to be of Roman date, except perhaps one which seems to have stood not far from the ‘Thrift.’ It was removed in March 1852, and there was found in the centre of it a grave 5½ ft. long and 2½ ft. deep, containing a skeleton, small bits of flint and chalk, bits of glass and a ‘Roman buckle.’ [Camden's *Brit.* (ed. Gough, 1789), i, 341; Cussans, *Hist. of Herts. Odsey Hund.* (1873), 98, 116; *Journ. Brit. Arch. Assoc.* (1853), viii, 371; *Proc. Soc. Antiq.* (ser. 2), i, 306.] See Royston and Kelshall.

THUNDRIDGE.—See Standon.

TOP STREET.—See Harpenden.

TRING.—A cemetery was found in making the L. & N.W.R. line ‘where it crosses Icknield Street,’ presumably at Folly Bridge, 1½ miles north of Tring and on the Buckinghamshire border.

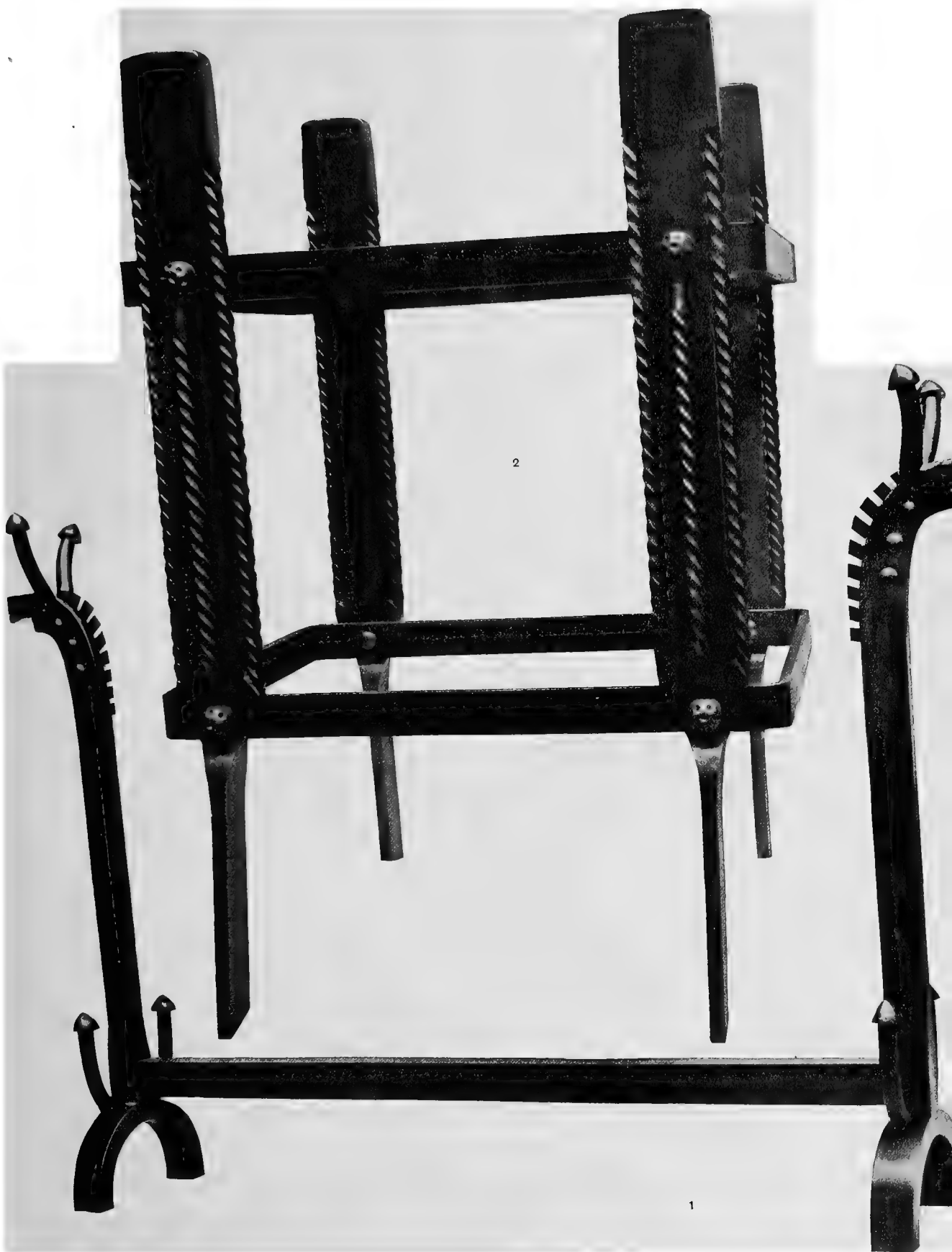

WELWYN : MODELS OF FIRE-DOGS AND IRON FRAME
PLATE XVII

CELTIC AND ROMANO-BRITISH HERTFORDSHIRE

Sixteen skeletons had been buried by the side of the road and with them was 'an immense quantity of Roman pottery and oyster shells.' Much of the pottery was broken when found, but there were several perfect cinerary urns, two being in the possession of the Society of Antiquaries in 1879. [Cussans, *Hist. of Herts. Dacorum Hund.* (1879), 13.] For other finds near here see Aldbury, Northchurch and Wigginton.

VERULAM, see p. 125.

WALDEN, ST. PAUL'S.—Roman coins have been found at Whitwell, south-west of Walden [*Arch.* liii, 262].

WALSORTH.—See Hitchin. For the find of Late Celtic urns in a chalk-pit half a mile from Icknield Way and $1\frac{1}{2}$ miles from Wilbury Hill, and probably in this parish, see Norton and *V.C.H. Herts.* i, 236.

WARE.—Two burials were discovered in building a new lock on the River Lea in Priory Street, 400 yds. north-west of the Priory, August 1831. They lay in a stratum of peat, 50 yds. from the left bank of the ancient river course, and must have been at the side of Ermine Street. The first was found lying east and west at a depth of 3 ft.; 9 in. below the skull part of a steelyard turned up, the weight and a brass coin of Domitian (A.D. 81–96) being 9 in. below it again (i.e. $4\frac{1}{2}$ ft. deep). Near it also were 'a brass candlestick of curious workmanship,' an iron axe-head and a finger-ring. The second skeleton was a little to the south, also in the peat, and near it were a pin, a key, two millstones of Hertfordshire concreted gravel, fragments of a large earthen vessel with a base and rim 33 in. circumference, and a brass coin of Didius Severus (A.D. 193), Cohen, no. 17–19. [*Arch.* xxiv, 350, hence Cussans, *Hist. of Herts. Braughing Hund.* (1870), 155; *Gent. Mag.* (1831), ii, 454]. Four stone coffins were discovered in a field called Bury Field, just to the north of the above, in February 1802. No small objects are recorded, and from their shape they may equally well belong to a post-Roman as to the Roman period, and Ware Priory lies quite close. A small copper coin of Constantine I (A.D. 306–37) occurred 'in the mould' (i.e. the soil) near them, however; and in 1899 finds of Roman pottery and coins were made in the site of Messrs. Allen & Hanbury's factory in the same field, and probably indicate a burial-place along the side of Ermine Street. Among the vessels were part of a large Samian patera, about 10 in. in diameter, stamped 'CONSTANS F,' other fragments of Samian, pieces of Castor ware, a colander in grey ware $4\frac{1}{2}$ in. diameter at the bottom, pieces of white and fine black ware and rough grey ware, including two urns 14 in. and 8 in. high and 6 in. and $3\frac{1}{2}$ in. in diameter at the mouth respectively, which may possibly not be Roman. The coins were a 'second brass' of Vespasian (Cos. III) (A.D. 69–79), another of Commodus (A.D. 180–93), a 'third brass' of Constantine I (A.D. 305–6) in poor condition, and two others illegible. A small bronze spear-head also appears to have been turned up at the same time. A skeleton, ring, Roman key, steelyard and coins of Domitian and Severus were found also in 1830 near the same field [*MS. Min. Soc. Antiq.* xxxvi, 151; *Gent. Mag.* (1802), i, 393, plate i, and 6-in. O.S. Map, xxix, S.E.]. A house or village may have existed somewhere near the bridge or ford across the river [Andrews, *East Herts. Arch. Soc. Trans.* i (2), 187–90]. A section of Ermine Street was opened in Barrowfield on the golf links at Chadwell, but for that see Roads, p. 145.

WATFORD.—Cussans mentions a 'Roman interment' from a barrow which was levelled about 1860 in digging for gravel beneath it. It stood south-west of Munden House, on the banks of the River Colne. Some 'Roman tiles which probably surrounded the interment' were in his day at Munden House, and he knew of a tradition of 'several gold things and copper coins and a lot of pickle jars with burnt bones in them.' [Cussans, *Hist. of Herts. Cashio Hund.* (1881), 181]. Boyden's Hill lies about 2 miles to the south-east, where tiles have been found (see Aldenham), and the Radlett kilns about $1\frac{1}{2}$ miles east.

WATTON AT STONE.—Roman coins were found here in the 18th century, according to a MS. letter from the Rev. Geo. North, vicar of Codicote, to Ducarel, 4 November 1742 [now in a copy of Salmon, *Hist. of Herts.* 147, in the Bodleian (Gough, *Herts.* 18)]. He also mentions the so-called Roman milestone, 'a large weather-beaten stone with all the signs of a great age,' at the parting of the Stevenage and Walkern Roads. In Cussans' day it supported a horse-trough outside the Wagon and Horses Inn, near the River Beane, but it may as well be prehistoric as of Roman date. It is said to have given its name to the parish. [From North but misquoting the reference, Clutterbuck, *Hist. of Herts.* (1829), ii, 472; Cussans, *Hist. of Herts. Broadwater Hund.* (1877), 167].

WELWYN.—Welwyn was the burial-place of some family of importance in the latter part of the 1st century B.C. Two vaults and two separate burials were discovered in the autumn of 1906 during the diversion of the station road by the late Mr. G. E. Dering of Lockleys. The actual site of the graves was in the new road, some 500 ft. to the east of the London Road. The objects, several of which must have been of a costly nature for the period to which they

A HISTORY OF HERTFORDSHIRE

are assigned, were given by Mr. Dering's daughter, Mrs. Neall, to the British Museum. Unfortunately, no accurate observations were made at the time the burials were found. In the first vault were an amphora of Greek type and origin, angular at the shoulders and pointed below; two fire-dogs or andirons ($53\frac{1}{2}$ in. wide at the top and 46 in. below and 38 in. high), the uprights of which (2 in. by $\frac{3}{4}$ in. in section) stand on arched feet and terminate at the top in what are apparently intended for bulls' heads having knobbed horns, and a cross-bar (2 in. by $1\frac{1}{2}$ in. in section) between the uprights 6 in. from the ground (Pl. xvii); some fragments of a bronze bowl ($12\frac{4}{5}$ in. diameter and $4\frac{3}{10}$ in. high) of classical design, with a base ($6\frac{1}{2}$ in. diameter and $1\frac{1}{10}$ in. high) having an edge moulded with egg-and-tongue pattern, and with drop handles and a lip formed by bending back the metal; three heavy bronze masks of purely Celtic origin ($1\frac{1}{2}$ in. long), curved at the back to fit a circular object, the faces showing straight hair and heavy moustaches (Pl. viii); handle of bronze jug of Italian manufacture, possibly from the Capua district; a cordoned pottery tazza of Late Celtic type and the base of a pedestal urn. The second vault contained five amphorae similar to those in the first vault; two similar fire-dogs; an iron frame (42 in. high, $28\frac{3}{4}$ in. long and $22\frac{1}{2}$ in. wide), possibly used for sacrificial

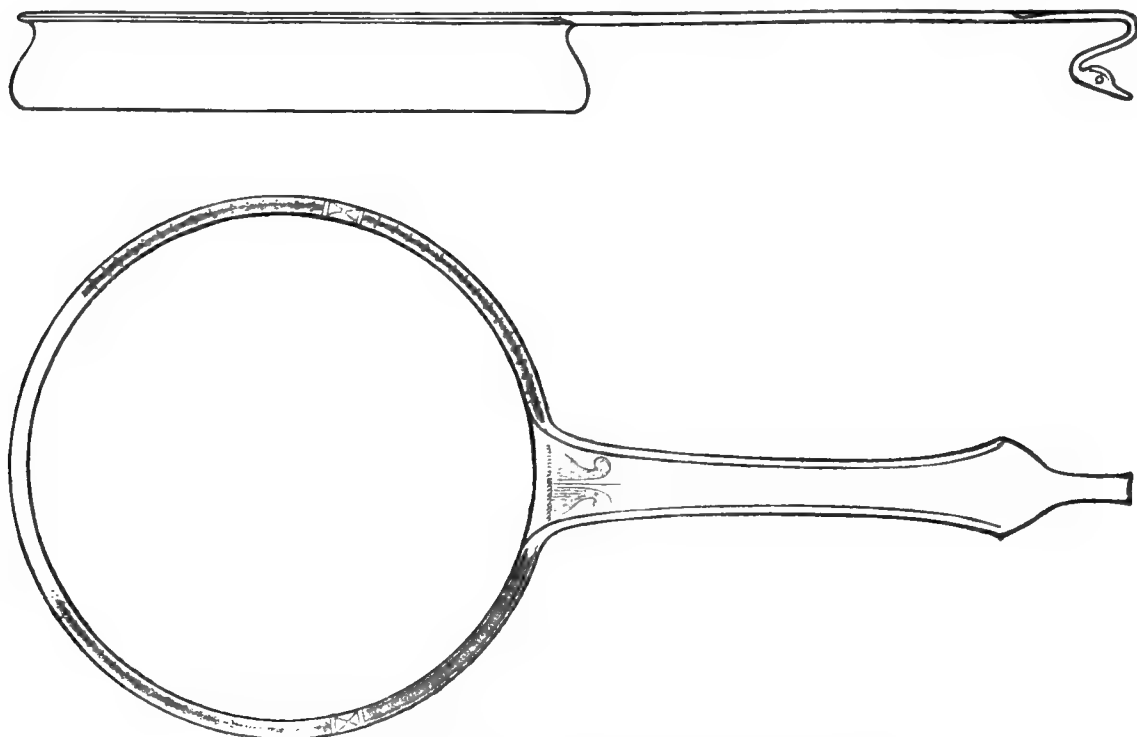

LATE CELTIC BRONZE PATELLA FOUND AT WELWYN (restored) ($\frac{1}{2}$)

purposes, composed of four uprights (4 in. wide) ornamented with twisted bar iron and two horizontal bands (2 in. wide) (Pl. xvii); a bronze patella (24 in. long, $11\frac{1}{2}$ in. diam.) with long handle; the handle and a part of the body of a bronze jug of Italian type, similar to the handle in the first vault but larger; the bronze handle and lower edge of a Late Celtic tankard; a bronze ring ($1\frac{7}{10}$ in. long) with rivet or knob, possibly for lifting pail by attachment to the handle; a pair of silver vases (4 in. high, $4\frac{1}{4}$ in. diam.) of classical origin (Pl. viii), each ornamented with egg-and-tongue pattern round the lip, with a guilloche pattern between beaded borders below, and round the foot is a beaded edging below egg-and-tongue border; a pair of silver kylix handles (3 in. long) of classical workmanship; bronze domes, two $1\frac{1}{2}$ in. diameter and about fifteen $\frac{9}{10}$ in. diameter, probably for covering rivet heads; a pedestal cinerary urn and a cordoned pottery tazza. The separate burials contained pottery only; the one held a pedestal cinerary urn, a barrel-shaped vase and two bowls with burnt bones, and the other a small pedestal urn, a vase with oval body and a small tazza. It is an interesting fact that the amphorae and all the bronze and silver objects of classical design show distinctly the influence of Greek craftsmanship. [*Arch.* lxiii, 1-30].

(1) 'The most important building which has been discovered is the remains of a house in the rectory gardens. Flint walls, forming an angle, were found in 1906 facing the north-east

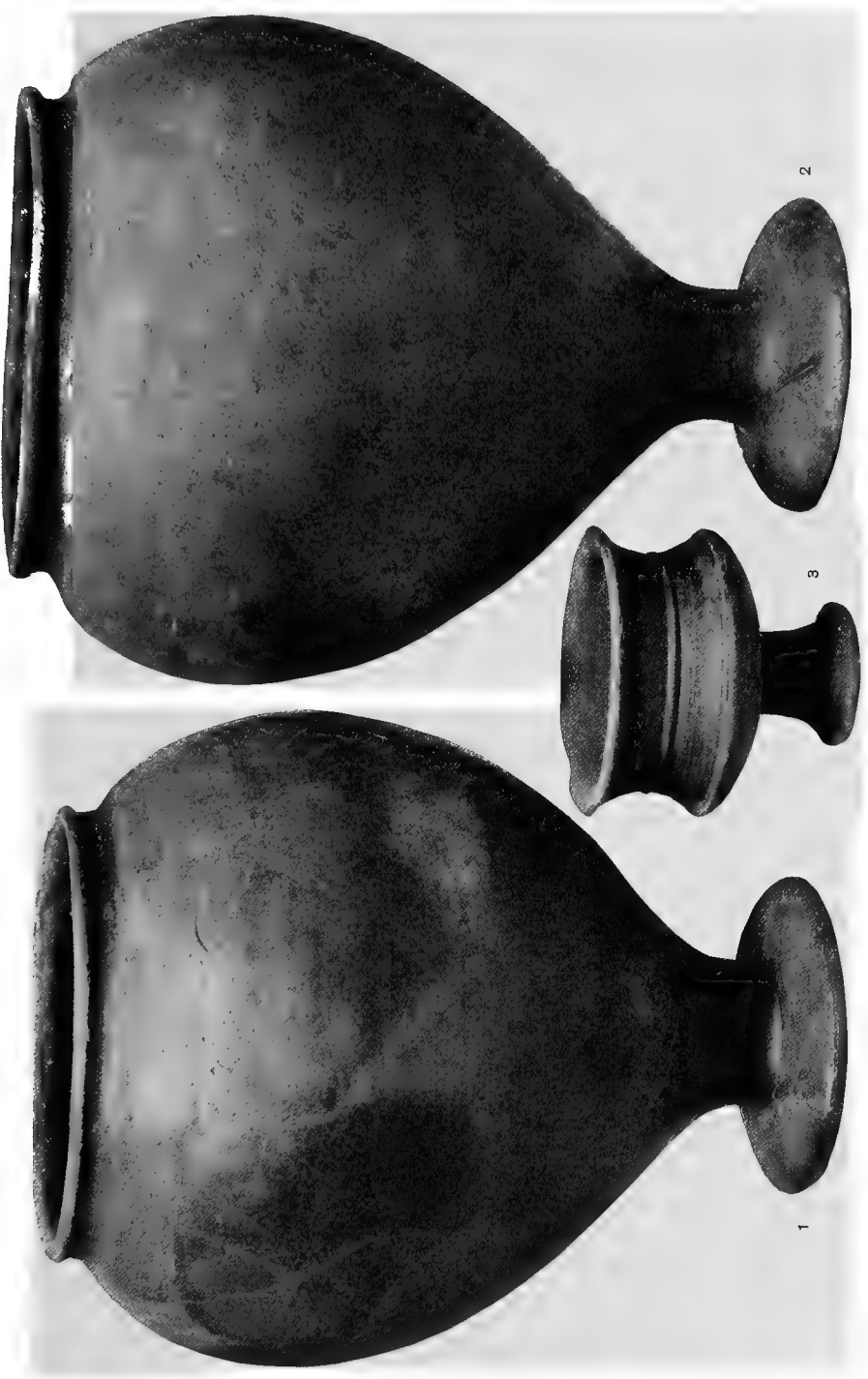

WELWYN : LATE CELTIC CINERARY URNS AND TAZZA
PLATE XVIII

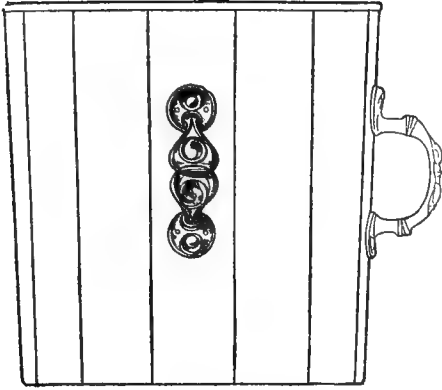

WOODEN TANKARD (restored) AND BRONZE HANDLE (FRONT AND SIDE VIEWS) ($\frac{1}{2}$)

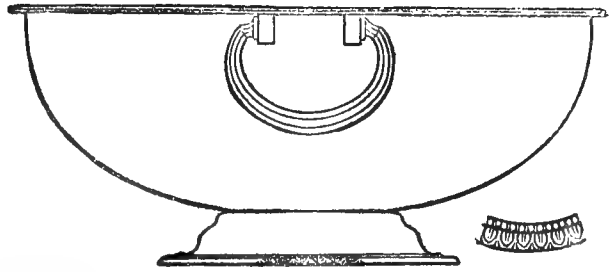

BRONZE BOWL ON FOOT (restored) ($\frac{1}{2}$)

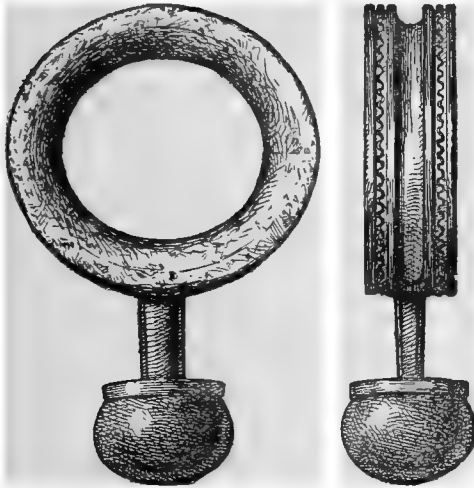

BRONZE RING WITH KNOB ($\frac{1}{2}$)

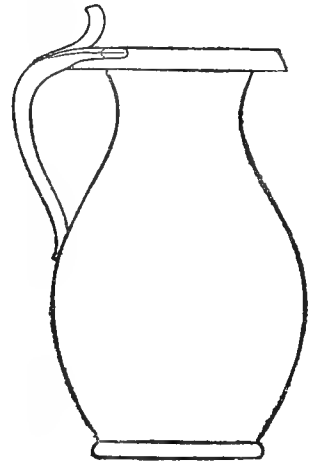

BRONZE JUG (restored) ($\frac{1}{2}$)

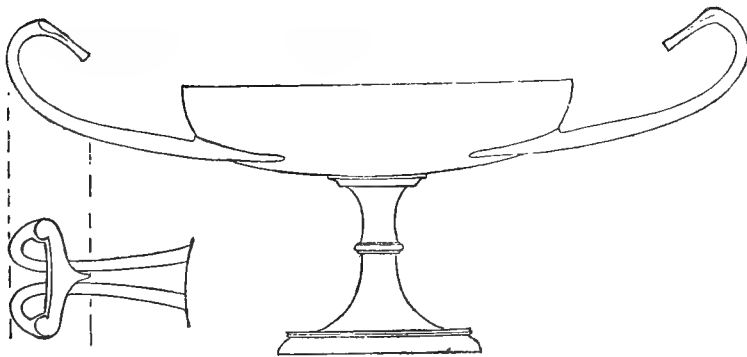

SILVER HANDLES, WITH SPECIMEN KYLIX ($\frac{1}{2}$)

LATE CELTIC ANTIQUITIES FOUND AT WELWYN

A HISTORY OF HERTFORDSHIRE

corner of the rectory, which lies on the western bank of the River Maran or Mimram, between a croquet lawn and the house, 6½ ft. from the former. The walls were 2½ ft. thick and were well built with lime and mortar, the flints being laid in courses, but no tiles occurred *in situ*. A space measuring 10½ ft. by 4½ ft. was opened up, but revealed no trace of the floor. Many brick and roofing tiles were turned up, only one hypocaust tile, a coarse dark urn, 8 in. high, from just inside the angle, bits of thin bronze plate and wire, three brass coins of Constantine I (A.D. 306–37), many oyster shells and animal bones, and some evidence of fire was observed. When the lawn itself was being made in the autumn of 1906 no masonry occurred, but a number of hard, round pebbles, bedded on chalk and burnt lime, and burnt bright red, also a great quantity of Roman bricks and roofing tiles (all broken), numberless pieces of pottery, including Samian, one bit stamped “SECUNDINAA” (*sic* —? MA. Secundinus is a Lezoux potter of the first half of the second century; see Curle, *Roman Frontier Post*, 240), and Castor ware, broken glass, handle of a blue-green vessel with a wavy line of blue glass on it, a bead of the same colour; in bronze, a piece of a brooch, a ring 1 in. in diameter, a signet ring engraved with a winged female (? Victory), an ornamented pin 4 in. long, a bit of twisted band (? bracelet) tweezers, an object like a jew’s-harp, &c.; a barbed iron arrow-head, many nails and bits of iron, and over forty bronze coins including two Pius (A.D. 138–61), one Faustina II (A.D. 161–80), one Tetricus (A.D. 268–73), one or two Carausius (A.D. 286–93), three Constantine I (A.D. 306–37), eight illegible. There was also a rubbish pit, but it was not cleared to the bottom.’ [Mayes, *Bedfordshire Express*, 15 December 1906]. A ‘second brass’ coin of Decentius (A.D. 351–3) was found in the rectory grounds in May 1901, and later a ‘third brass’ of Gratian [*East Herts. Arch. Soc. Trans.* i (3), 364; *Antiq.* Jan. 1911, pp. 7, 8]. (2) A denarius of Hadrian and a brass of Gratian were found in 1908 at Guessens on the east bank of the River Mimram, just west of and opposite to the church. Numerous fragments of pottery and a silver denarius of Titus (A.D. 79–81) have been found in the churchyard [*Antiq.* loc. cit.], and during the recent alterations at Welwyn Church it was discovered that Roman bricks were largely used in the west front and the foundations of the tower [*ibid.* 9 n.]. These bricks may have come from the house at the rectory or from a building at the Grange, where much pottery has been found on rising ground north of the church (Pl. ii, iii, v). In July 1908, in making a lawn at the back of the house, a number of Roman tiles were found with a large quantity of flints and mortar, showing the action of fire, and heavy metallic clinkers, perhaps indicating a pottery kiln. A hundred yards away, to the north-east of the Grange, in a strip of meadow measuring 10 ft. by 35 ft., also at the back of the Grange, and 150 yds. north of the church, a burial place was opened. It contained the remains of over 150 vessels of Samian, Castor, Upchurch, so-called Salopian, and other wares of the Romano-British period. Many of them were cinerary urns in grey, red and white ware, varying in height from 7 in. to 11 in., and in many cases the calcined bones were covered with Samian and other saucers, the burials being arranged 3 ft. or 4 ft. apart, 2 ft. to 3 ft. from the surface. Many of the vessels seem to have been damaged before burial, and two of the Samian paterae were mended with rivets. The pottery is now in Mr. Andrews’ Museum, Hertford [R. T. Andrews in *Antiq.* Feb. 1911, p. 53; Mayes, *East Herts. Arch. Soc. Trans.* iv (1), 117–18]. Amongst the fragments of Samian ware was a complete example of a type dredged from the Puddingpan Rock, 4 miles off Herne Bay. It agrees in shape, colour and quality with Form 3 of that series. It bears the stamp MAIORIS hitherto confined to Forms 10, 11 and 13. It was apparently made at Lezoux in the 2nd century. A Samian cup of lighter colour resembling others found at Bayford (Kent); a ‘thumb-pot’ with seven indentations of pale yellow ware with black slip 4½ in. high; a vase of hard buff ware with egg-shaped body 7¾ in. high; another with white slip, 5¾ in. high; a pot of hard reddish ware with broad vertical band on the lip 4 in. high; and an elegant carinated vase with dark grey surface, 5½ in. high [*Proc. Soc. Antiq.* xxiv, 134. For account of Puddingpan examples, *ibid.* xxi, 280; xxii, 403, where Genitor’s Form should be 10, 11 and 12, not 9, 10 and 11.] A little Samian pot ornamented with stags and trees was found in a gravel-pit near the cemetery, and is now in the possession of Sir Alfred Scott-Gatty. Two urns were found at Myrtle Hall, now the Hall, on the Danesbury estate in 1907, to the south-east of the burial place [*Antiq.* Jan. 1911, p. 9]. (3) Samian, Upchurch and New Forest ware, three coins, bracelets and brooches, some set with light blue stones, and an enamelled handle (*sic*) were found in making a new road from Mill Lane to the Hertford road and the railway station, just south of Welwyn [*Antiq.* Jan. 1911, p. 7].

Coins of Pius (May 1903), Faustina wife of Constantius II (A.D. 337–61) (March 1904), and Gratian (A.D. 375–83) (March 1904), also some of Trajan (A.D. 98–117) and Marcus Aurelius (A.D. 161–80), and other coins have been found in Welwyn and the neighbourhood, and lastly the following burials: (1) In a meadow at the back of the Frythe, three-quarters of a mile

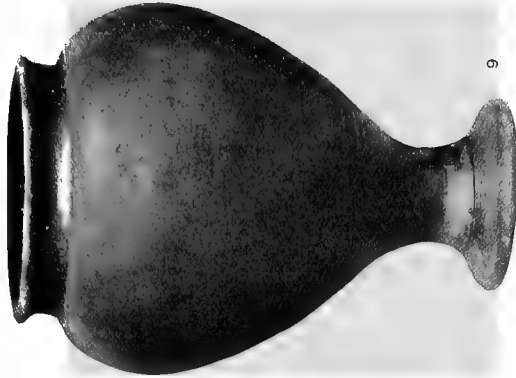
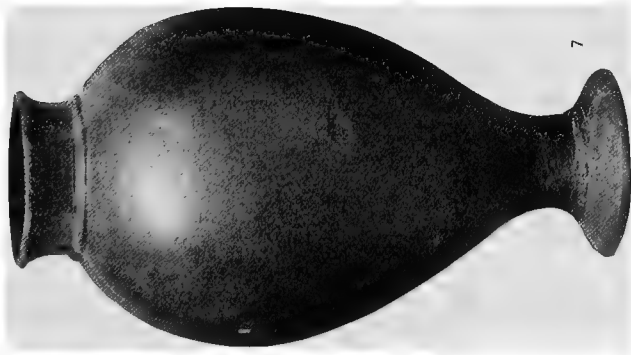

WELWYN : LATE CELTIC POTTERY
PLATE XIX

CELTIC AND ROMANO-BRITISH HERTFORDSHIRE

south-west of the rectory, five urns very imperfectly burnt, 8 in. diameter, containing ashes, and a small bent bronze plate about 1886; (2) an amphora without handles, 2 ft. 4 in. high and 11½ in. diameter, full of brown dust, and apparently another was found in October 1904 in a gravel-pit in the Mardleybury grounds north of the Great Northern tunnel, nearly two miles north-east, now in the Hertford Museum; a third has since been found [*Antiq. loc. cit.*; Rev. A. C. Headlam, *Herts. Mercury*, 13 May 1905; *East Herts. Arch. Soc. Trans.* iii (1), 32]; (3) two urns containing bones and a bronze *fibula* from the side of a chalk-pit at Welwyn were shown to the Society of Antiquaries on 8 August 1742 [MS. Min. Soc. Antiq. 8 Aug. 1742]. At Harmer Green, about 1½ miles from Welwyn, some foundations of uncertain date, possibly Roman, were found in 1904 [*Antiq.* Feb. 1911, p. 54]. The buildings and numerous burials and small finds testify to the existence of a village here, or settled site of some kind, in Roman and perhaps pre-Roman times. The straight piece of road running north-east out of Verulamium and traced to within about 2 miles of Welwyn, probably connected the town and village. For this see Roads.

WESTMILL.—Some labourers in hollow-ditching in a field called ‘Lemmonfield adjoining the parish of Westmill’ in May 1729 came across three amphorae in a row ‘a little inclining’ 18 in. below the surface. They were pale red, 40 in. long, pointed at the bottom, narrow-necked and two-handled, and full of dust and chalk. Two were said to be inscribed: on the rim of one there was said to be ‘P.R.A.’ which is perhaps a misreading of ‘FARNA’ figured by another writer. The neck of the last-mentioned was 12 in. long. Horsley read the stamp as Farnia and Hübner as perhaps ‘P.Ar. . . Va. . .’ An amphora thus inscribed was found at Colchester and another at Etampes [*Corp. Inscr. Latin.* vii, 1331, 17, 18; xiii, 10002, 3502], the last being read ‘P.Arva.’ Many bones are said to have been found in the neighbourhood. Westmill is on Ermine Street and Braughing is only 1½ to 2 miles south-east. [Salmon, *Surv.* (1731), ii, 423; Gough’s copy of Horsley, *Britannia Romana* (Bodl. Lib., Gough Gen. Topog. 128); Camden’s *Brit.* (ed. Gough, 1789), i, 345, pl. xvii, fig. 2, quoting Ward’s MS. additions to Horsley, hence Brayley and Britton, *Beauties of Engl. and Wales*, vii, 206; and Cussans, *Hist. of Herts. Braughing Hund.* (1870), 202, also quoting Ward’s Excerpta Misc. ii, now in Brit. Mus. Add. MS. 6229, fol. 106].

WESTON.—Mr. Seebohm mentions Roman coins found here [*English Village Community* (1884), 434].

WIDFORD.—According to Cussans, there were ‘two Roman barrows, one of which was partially opened . . . in 1851, when a few objects, but none of great archaeological interest, were discovered’ in a field on the eastern side of the River Ash [*Hist. of Herts. Braughing Hund.* (1870), 55; cf. Sawbridgeworth]. No trace can now be discovered of these finds, which apparently were made by Lord Braybrooke [Paper by E. E. Squires].

WIGGINTON.—Tiles and coins which have been discovered here may indicate the presence of a building of some sort in the neighbourhood [*Gent. Mag.* (1811), i, 388]. Coins and a gold ring were found at the Cow Roast Inn, half a mile east, but in the parish of Northchurch (q.v.) as marked on the 6-in. O.S. Map, sheet no. xxv, S.E. See also Northchurch, Tring and Aldbury. Akeman Street begins to run in a fairly straight line a little to the north-west of Wigginton.

WILBURY HILL.—See Norton.

WILLIAN.—A Roman interment and coins are recorded by Mr. Ransom in *Arch.* liii, 262; Seebohm, *English Village Community* (1884), 434. See also Royston.

WYMONDLEY, GREAT.—This parish has been very productive of Roman finds. (1) ‘Lines of stone about 2 ft. deep, running at right angles to one another,’ without mortar, were found in the field that contains the two mounds to the east of St. Mary’s Church, while a line of black earth, which turned out to be a ditch full of Roman objects, was observed running from north to south, across the field east of that last mentioned, and also in the field opposite it on the north side of the Graveley Road. It contained a quantity of Roman brick and roofing tiles, ‘heaps of Samian ware, several pieces of Castor, some of Upchurch, and also pieces of New Forest pottery, strainers and parts of 6 *mortaria*,’ pieces of Andernach querns, hones, stone weights, fragments of glass, a strigil and pieces of bronze, a key, knives, horse-shoes, many nails and spikes, a large number of knuckle-bones used as dice, cores of ox-horns (probably *bos longifrons*), bones of horse, sheep and hog, oyster shells and the following coins:—

Vespasian [A.D. 69–79]	Tetricus I [A.D. 268–73]
Nerva [A.D. 96–8]	Tetricus II [A.D. 268–73]
2 Pius [A.D. 138–61]	Allectus [A.D. 293]
Marcus Aurelius [A.D. 161–80]	2 Constantine I [A.D. 306–37]
2 Gallienus [A.D. 253–68]	Crispus [A.D. 317–26]
Salonina [A.D. 253–68]	Constantine II [A.D. 317–40]
Postumus [A.D. 259 ?–69 ?]	Julian [A.D. 360–3]

A HISTORY OF HERTFORDSHIRE

About 150 yds. east of this find, in the north-east corner of a field at the junction of the Great and Little Wymondley and Graveley roads, a cemetery was found in 1882. Forty-three urns containing burnt bones, charcoal and iron nails, each with a Samian saucer and 'wine bottle,' and sometimes other small vessels were turned up within a space measuring 5 yds. by 7 yds. The pots were all of different shapes, sizes and colour, and forty-five different varieties were observed, many of which are figured. The drawings are not very good, but one of the urns or 'cooking pots' seems to resemble those figured in Pl. L.B. (3) of Curle, *A Roman Frontier Post*, which are dated to the late 2nd century; two like Ludowici, *Römischer Töpfer in Rhein-zabern* (1905-8), iii, 264, P. 14, 265 V. 7, both apparently also of the 2nd century. One Samian cup Drag. shape (33) and eight Samian paterae are also shown, three of which are stamped 'ANELLI . OF' (? 'Anailli of,' which occurs mostly on the Rhine and in the Low Countries), 'DOCCIVS . F' (found at Caudebec-les-Elbeuf and Vichy, London and York), 'ROMVLI . OF' (found in the Allier and Rhone Valleys, Aosta and at Colchester). The first-named might possibly be the 'viertel-rund' type, usually an early one, but the character of the drawing makes it impossible to be certain.

'Fragments of pottery and Samian ware were turned up in almost every part of the quadrangular inclosure, which can be distinctly traced from the raised ground and trenches

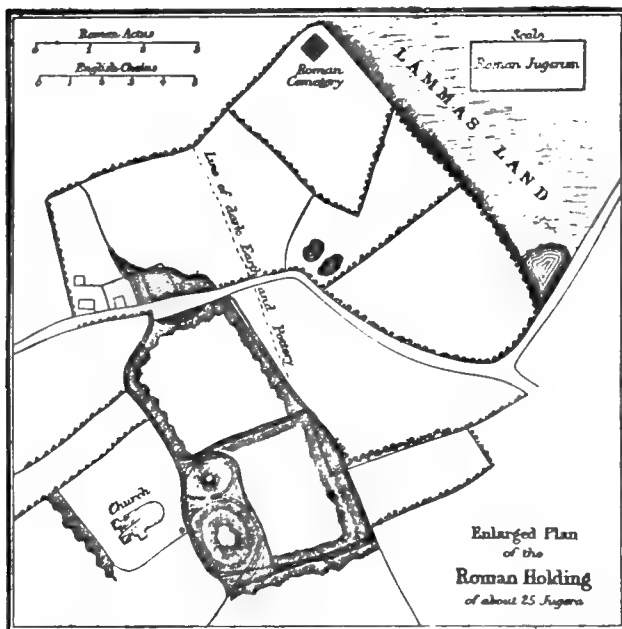

PLAN OF ROMAN HOLDING, GREAT WYMONDLEY
From *English Village Community*, by F. Seebohm

encircling it, measuring about 20 acres' and included the cemetery (see map). These finds are noteworthy because they, together with the square shape of the two fields adjoining the mounds, 'still distinctly surrounded by a moat,' are considered by Mr. Seebohm as evidence of the continuity of occupation from the Roman period. He held that the inclosure and its contents were the remains of a 'little Roman holding,' forming a rough square and containing about twenty-five Roman jugera (17-18 acres) if the corners were filled in. While it seems incredible that the field divisions should never have been altered since the Roman occupation, yet it cannot be denied that a Roman settlement of some kind existed here during almost the whole of the Roman period, and therefore probably a Roman holding of some type. But it

is dangerous to state precisely what character this assumed, especially as it is not even known whether the occupation took the form of a 'villa' or village. The remains seem to indicate the latter, since no actual structure has yet appeared or been recorded. The whole question must remain in doubt until the site has been carefully excavated and our knowledge is a little more definite on the subject of land tenure in the Roman provinces. The mounds belong to the 'moated and bailey' type and were inserted into the corner of a larger and apparently earlier rectangular work, while the small cross ditch is a modern field division. Many of the earthworks shown on Mr. Seebohm's plan are now merged in field banks and ditches and are not clearly traceable. [Ransom, *Herts. Nat. Hist. Soc. Trans.* (1886), iv (2), 40-2, with plates; Seebohm, *English Village Community* (1884), 431-2, with plan and same plate; *V.C.H. Herts.* ii, 119, and plan; and I. Chalkley Gould, *East Herts. Arch. Soc. Trans.* iii (1), 10, 11].

(2) Part of a dwelling-house was excavated in the autumn of 1884 by Mr. Ransom and Mr. Hill in a field close to Purwell Mill (Pl. xx). The exact site is not given, but is described as 3 furlongs from the cemetery noticed above. Some six rooms were opened and planned, covering an area that measured 113 ft. by 41 ft. Three of them (1-3) were provided with pillared hypocausts, 13 in. high, connected by flues with two or three furnaces, one of these being added at a later date and its entrance paved with roof tiles. A small chamber (4)

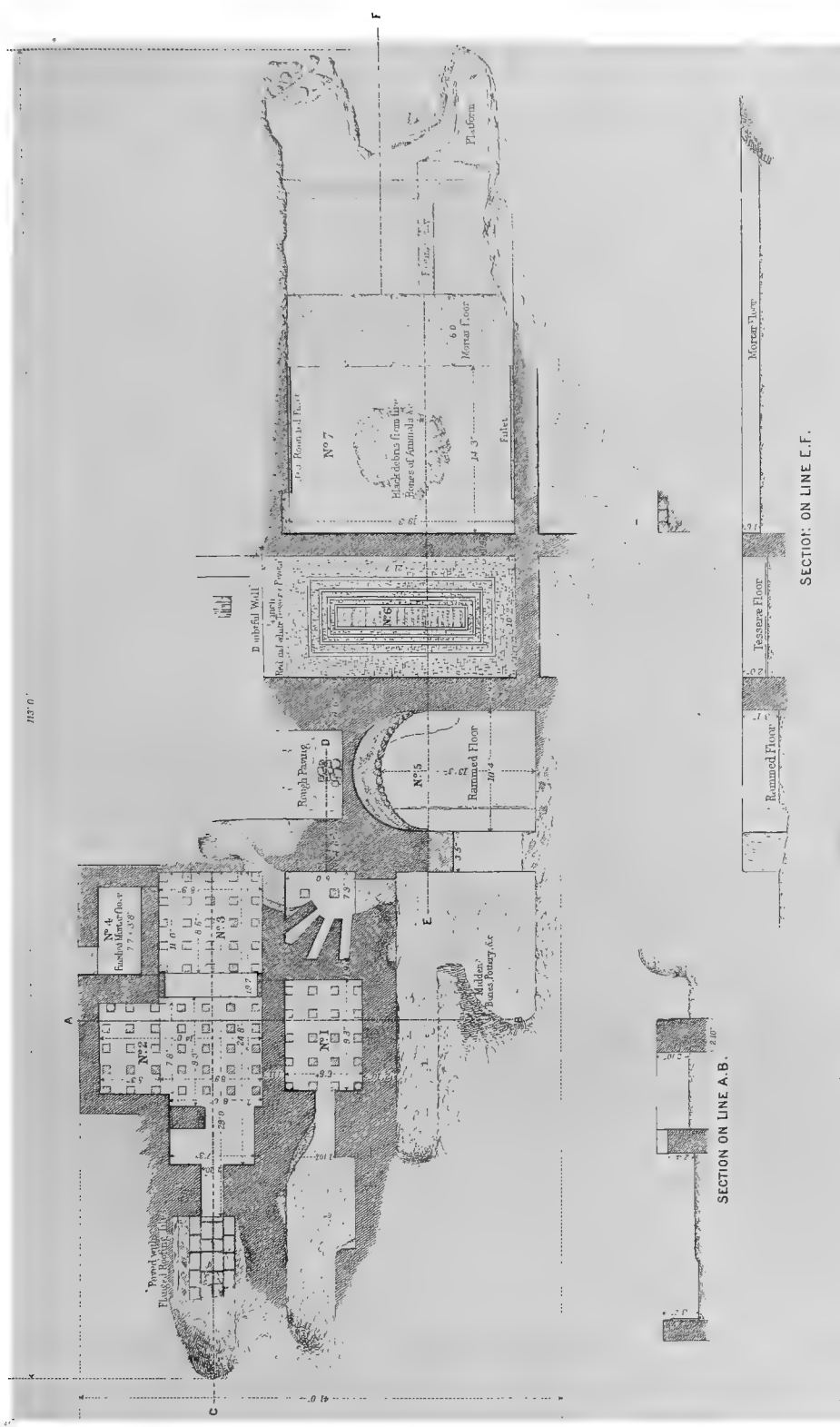

PLAN OF
ROMAN VILLA
 excavated near Huchim, Nov. 1884
 on the estate of C.W. Wislizenus Esq.

SECTION ON LINE E.F.



SECTION ON LINE A.B.



SECTION ON LINE C.D.



CELTIC AND ROMANO-BRITISH HERTFORDSHIRE

measuring 7 ft. 7 in. long, 3 ft. 8 in. wide, and paved with a floor of mortar was built into one room (3) and was probably a bath, for the rooms adjoining it (1-3) appear to have been the bath buildings of the house. A later partition wall divided the originally large room into two (2 and 3). They were separated from the rest of the house by a room (5) with walls $4\frac{1}{2}$ ft. thick, one end of which had been worked into an apse. It was $10\frac{1}{8}$ ft. wide and $13\frac{1}{2}$ ft. long, and was paved with a very hard rammed-concrete floor 14 in. thick. Outside the apse pieces of stone paving occurred. Adjoining it was a room (6) 21 ft. 7 in. long, 10 ft. 2 in. wide, and its floor a foot higher than (5) and covered with a tessellated pavement in red and white parallel lines with a 'gridiron pattern' in the centre. Beyond it were two other rooms, one with a rounded fillet on two sides and containing a deposit of charcoal and many animal bones on the centre of its 'mortar' floor, which was 6 in. above (6). More rooms were traceable in this direction, but were not planned, for the floors were here level with the present surface and had been destroyed by the plough. The walls varied in thickness from 1 ft. 9 in. to 2 ft. 10 in., and everywhere were very close to the surface. They were built of flint and mortar with tiles at the quoins and sometimes in bonding courses, and in the face of the divisional wall of (3) was 'herring-bone walling with radiating bricks.' Painted wall plaster occurred and a rubbish pit full of bones and pottery outside the big furnace. 'Many cart-loads of broken roofing, flooring and flue tiles' and faced flints were removed. The small objects found in the débris included Upchurch ware, white *mortaria*, a perforated lid, glass 'vessels of fine quality,' thick bottle glass and window glass, a bronze steelyard, pieces of bronze, an iron gouge, a key, a style, nails, bone pins and a 'band for ladies' hair,' bones of ox, sheep, red-deer, swine, goat, fox and birds, and quantities of oyster shells—the bones and shells found on the floor of room (7) and the following coins :

Gallienus [A.D. 253-68]	Allectus [A.D. 293]
2 Victorinus [A.D. 265-8]	Constantine [A.D. 306-37]
Tetricus [A.D. 268-73]	2 Valentinian II [A.D. 375-92]
Tetricus II [A.D. 268-73]	3 Barbarous imitations
Carausius [A.D. 286-93]	

The field in which the building stood yielded the following :

Severus [A.D. 193-211]	Crispus [A.D. 317-26]
Gallienus [A.D. 253-68]	2 Constantine II [A.D. 337-40]
Salonina [A.D. 253-68]	2 Constans [A.D. 337-50]
Victorinus [A.D. 265-8]	Constantius II [A.D. 337-61]
Tetricus I [A.D. 268-73]	Magnentius [A.D. 350-3]
Tetricus II [A.D. 268-73]	Valentinian [A.D. 364-75]
Claudius Gothicus [A.D. 268-70]	Valens [A.D. 364-78]
Carausius [A.D. 286-93]	Gratian [A.D. 375-83]
Allectus [A.D. 293]	Several barbarous imitations
4 Constantine I [A.D. 306-37]	

It is obvious that here we have only a small part of a building, and too small even to discover to what type of house its plan belonged. To judge from the coins, it was not built till the beginning or middle of the 3rd century A.D., like many of the houses in Britain. It was occupied for some time, as the excavators observed many traces of structural alterations, and it was still standing in the late 4th or early 5th century, when no doubt it formed a shelter to some members of a more uncivilized race, unused to baths or kitchens, who cooked their food on an open fire made in the middle of the large room, leaving split marrow and other bones as traces of their habitation. Charcoal and ashes also occurred in the centre of most of the rooms and were thought to be the remains of primitive fire-places, not of the burnt roof. If this is so the large amount of building débris lying above the foundations and other lack of evidence of fire (unless it has not been recorded) suggest that the house was allowed to fall into ruins and was not destroyed by violence. [Ransom, *Herts. Nat. Hist. Soc. Trans.* (1886), iv (2), 43-6, with plan].

WYMONDLEY, LITTLE.—A cemetery was found about 5 ft. below the surface about 1847 in excavating a river 2 miles long near Little Wymondley, apparently not far from Stotfold Mill, but the site is not precisely described. It contained many plain vases or urns of rough yellow clay, some containing bones and smaller vessels. One jug-shaped bottle at least was found. Near them lay a few small iron nails with thick heads and bent and arranged in a semicircle and equal distances apart, probably binding some wood or leather object. No other details are given. [*Journ. Brit. Arch. Assoc.* (1849), iv, 72-3]. See also Hitchin, where many Roman finds have been made, and Willian.

YOUNGBURY.—See Standon.

A HISTORY OF HERTFORDSHIRE

APPENDIX ON THE NAME 'COLDHARBOUR.'

It has been shown in other volumes of the *Victoria County History* (see especially *V.C.H. Hants*, i, 349) that the name 'Coldharbour' does not necessarily indicate a Roman site, as is often supposed and stated. This is particularly true of Hertfordshire, where the name occurs eight times, but only in one case (in Hemel Hempstead parish) near a known site of a Roman dwelling-place. Some burials have been found close to another 'Coldharbour,' but otherwise the name cannot be said to have any connexion with Roman finds in this county, as the following list will show: (1) In Sacombe parish, 6-in. O.S. Map Sheet No. xxi, S.E.; (2) Berkhamstead Common, Little Gaddesden parish, O.S. Sheet No. xxvi, S.W.; (3) Harpenden parish, O.S. Sheet No. xxvii, N.E.; (4) Stanstead Abbots parish, O.S. Sheet No. xxx, S.W.; (5) Boxmoor, Hemel Hempstead parish, O.S. Sheet No. xxxiii, S.E.; (6) Bishops Hatfield parish, O.S. Sheet No. xxxvi, S.W.; (7) St. Stephen's parish, O.S. Sheet No. xxxix, S.W.; (8) in Bushey parish, O.S. Sheet No. xliv, N.E.

SOCIAL AND ECONOMIC HISTORY

THE economic history of Hertfordshire is singularly constant to its original interests, namely, agriculture, the malt trade and the corn trade. It has been made by two factors, the one natural, being the suitability of the soil for tillage, and the other artificial, being the neighbourhood of London. During the 13th and 14th centuries there were found an activity and an ambition in the towns which have not had their due continuation.

The trade out of the county was small. Corn was already an export in 1247,¹ when ships came up the Lea to fetch it from Hertford. Already the influence of the London market was felt. The men of London had begun a capitalist enterprise against the local merchants. They built a granary for Hertfordshire corn at Thele, to which they sent their own ships instead of employing the 'king's ships of Hertford.'² This is an early instance of the economic attraction of London, which is a constant feature in Hertfordshire economic history.

In 1086 burgesses are found at Hertford, St. Albans, Berkhamstead, Ashwell, Stanstead, and at Cheshunt we hear of ten traders (*mercatores*). Hertford, the county town, had rights of toll at certain passages on the Upper Lea. At Stanstead some trade and industry gathered round the bridge of Thele at the junction of the Stour and the Lea. The modest prominence of Cheshunt may be due to its near neighbourhood to the Lea and London and a favourable situation at the junction of the Ermine Street with an old trackway running east and west. St. Albans was fostered by the abbey and Berkhamstead grew up under the shelter of a powerful lord. Ashwell on Ashwell Street and not far from the main track of the Icknield Way was, before the rise of Baldock, the chief centre of the rich corn lands of northern Hertfordshire.

With regard to Hertford it may well have outlived its greatest prosperity by 1086³; and in the 12th century it was evidently a poor place.⁴ It could not buy exemption from the jurisdiction of the sheriff,⁵ its aid was low and in 1177 one-ninth of the whole aid was remitted altogether.⁶

The town suffered in the wars of King John,⁷ but after this time the burgesses began to buy privileges. They farmed the borough, for a time at least, and bought a fair during the minority of Henry III.⁸ A certain

¹ Assize R. 218, m. 6 d.

² Ibid.

³ See under Hertford Borough.

⁴ Ibid.

⁵ Hunter, *Great R. of the Pipe* 1 Ric. I (Rec. Com.), 19, 20.

⁶ *Pipe R.* 23 Hen. II (Pipe Roll Soc.), 154.

⁷ See under Hertford Borough.

⁸ Ibid.

A HISTORY OF HERTFORDSHIRE

amount of trade was beginning to creep along the great roads and along the rivers again, and the ancient commercial privileges of the borough were worth reviving.

Hertford had possessed the monopoly of the passage of the Lea from Ware to Hatfield,⁹ and had also certain rights of passage at St. Albans and at Barnet. These last are hard to understand and probably refer back to a date when Hertford as the administrative and military centre of the county was the only town in which trade was permitted.¹⁰ But at Hatfield and Thele the burghal privilege probably amounted to a literal locking up of the ford, so that all traffic should pass through Hertford. At Ware the bridge end was barred, unless the king's bailiff came to unfasten the padlock.¹¹ Thus Hertford had a highly artificial monopoly of the passage of the Lea, and the king received large sums taken as tolls.

It is unknown when this monopoly was broken down at Hatfield and Thele, but in 1247 the men of Ware were accused by the burgesses of Hertford of passing freely with carts and on foot as well over the bridge of Ware as through the ford; and the beginning of the abuse was referred to the end of the civil war in 1216-17.¹² But as late as the early years of Edward I the bailiff of Hertford was still taking toll of goods passing over the bridge at Thele.¹³

The natural position of Ware, on the line from Royston to London, is better for trading purposes than that of Hertford, and the royal borough seems in the end to have lost its control over its neighbour.¹⁴ As early as 1247 the men of Ware began to forestall the market at Hertford by holding unlawful markets on the same days (Wednesday and Saturday), as well as their legitimate one on Tuesdays.¹⁵ Not content with this encroachment on the rights of Hertford, in 1275 they made weirs in the Lea, so that ships could not come to the borough, and at the same time diverted the king's highway which used to go from Ware to Hertford.¹⁶

Ware, which showed such vitality after the reign of John and the eclipse of Hertford, had received even earlier an impulse towards burghal organization from the 12th-century charter¹⁷ of Robert Earl of Leicester. Other Hertfordshire mesne boroughs date from the same period or a little later. Stortford was from its position bound to become a trading centre, and its privileges were fostered by the Bishop of London. Baldock, a borough of the Templars, dates from the last years of the 12th century. Standon, Hemel Hempstead and Sawbridgeworth may have acquired the burghal status with their markets. Watford is designated a borough even in the Quindecima Roll¹⁸ of 19 Edward I, and its trade was probably of long standing, since it lay on the water-way from Staines to St. Albans where the road from Aylesbury and the Midlands crosses the Colne.

Hitchin was originally a manor of the ancient demesne, but in 1268, besides other rents, there was due to the lord 8½ marks 'of the farm of the borough.'¹⁹ The borough had evidently an element of agricultural service,

⁹ Assize R. 218, m. 6 d.; Pipe R. 25 Edw. I, m. 23; see under Hertford Borough.

¹⁰ See account of Hertford, *V.C.H. Herts.* iii, 490-511.

¹¹ Assize R. 318, m. 6 d.

¹² *Ibid.*

¹³ *Ibid.* 328, m. 13.

¹⁴ See under Hertford Borough.

¹⁵ Assize R. 218, m. 6 d.

¹⁶ *Hund. R. (Rec. Com.)*, i, 194b.

¹⁷ *Cal. Pat.* 1446-52, p. 51.

¹⁸ *Lay Subs. R.* bdle. 120, no. 2.

¹⁹ *Chan. Inq. p.m.* 53 Hen. III, no. 43.

SOCIAL AND ECONOMIC HISTORY

as its boon days were worth 10s. 6d.²⁰ At the same time the tolls of the market amounted to 10 marks, which shows that it was well attended.²¹ There were also a malt-mill and a fulling-mill.²²

In the time of Henry VI the manorial court was called 'the Portman,'²³ and this seems to strengthen Hitchin's claim to burghal privilege. In 1290, however, 'the farm of the borough' no longer appears in the extent, and the assized rents are all grouped together. The amount of the demesne arable had been increased.²⁴ The agricultural element evidently prevailed over that of trade and industry, to which the privileges and standing of a borough would have been valuable.

Hertford and Hitchin and Ware met with little recorded interference from their lords, but St. Albans deserves to be the classical instance of hatred between a lord and his townsmen.

The market at St. Albans was established in the middle of the 10th century under the shadow of the wealthy abbey. Its site lay a little off Watling Street, but the road was diverted in order to bring the traffic along it to St. Albans. The town gradually increased in prosperity, and in the fifty years after 1216 it must have been as flourishing as any in the county. The inhabitants showed the true spirit of burgesses; but they could not aim at such privileges as Hertford held until they had proved, to the confusion of the Abbot of St. Albans, that they were freemen. The abbots, however, successively governed the estates of the abbey on two principles. They wanted to round off their immunity by buying out other immunists within their precinct. Thus the abbot purchased from Edward I the tolls at Barnet and at St. Albans which had belonged to Hertford.²⁵ Secondly, they stoutly maintained the villein estate of the townsmen with the consequent economic and legal rights over them.

In 1261-2 the jurors at the assizes complained that the 'abbot's steward put the freemen of the town to an oath without special royal warrant,'²⁶ thus tacitly denying their free status; the steward also forced them to answer in a foreign hundred, against the custom of the town,²⁷ thus ignoring the borough court.

The abbot naturally took the view that the men were his villeins born. In 1275 the vill again complained that the abbot claimed a weekly toll on brewing and on the merchandise of the burgesses.²⁸ He had also distrained the burgesses to do suit at his mill, which they used not to do; nor did he allow the hand-mills in their own houses, which they were accustomed to have.²⁹ The disputes, however, at first at all events, centred mainly round the question of multure. At Easter 1275 a jury was summoned to decide whether Michael son of Richard Brid ought to grind corn at the abbot's mill, and whether Henry de la Porte ought to full his common and thick cloth at the abbot's fulling-mill or in his own house.³⁰ The jury decided against the burgesses, and their verdict was confirmed in the following year.³¹

²⁰ Chan. Inq. p.m. 53 Hen. III, no. 43.

²³ Ct. R. (Gen. Ser.), portf. 177, no. 40.

²⁵ See under Hertford Borough.

²⁶ Assize R. 321, m. 1.

³⁰ Chan. Misc. bdle. 62, file 1, no. 15.

²¹ Ibid.

²² Ibid.

²⁴ Exch. Proc. bdle. 144, no. 133.

²⁸ Hund. R. (Rec. Com.), i, 192.

³¹ Ibid.

²⁹ Ibid.

A HISTORY OF HERTFORDSHIRE

Henry and Michael had a counterplea pending against the abbot, his steward and others for breaking into their houses and carrying off from Michael a bowl and the upper stone of a hand-mill, and from Henry a russet cloth worth 30s., and doing damage to the value of £100.³³ The steward claimed the bowl and justified the stone as a distraint; to which Michael answered that he and his ancestors were of such condition that they could grind where they pleased. Henry's plea was similar; but both men lost their case, the jury saying that Henry had himself had the abbot's fulling-mill at farm and had taken fines from those who fulled privately.³³

For one or more generations the quarrel between the abbot and his men rested on the question of suit at the abbot's mill, which being an incident of unfree tenure meant much to them. Time after time judgement seems to have been given against the townsmen. In 1312 the abbot sued Simon de Ickleford and Luke de Nedham³⁴ and in the following year he sued Robert de Limbury³⁵ and Benedict Spichfat,³⁶ who were supported by Richard de Tring, Geoffrey le Dyestre and Henry Spichfat. All these were apparently men of substance and leading townsmen. Benedict Spichfat was undoubtedly well off and paid 3s. to the subsidy of 1322-3.³⁷ But the question of the hand-mills was not the sole point of dispute. In 1313 Peter le Keu, Benedict Spichfat and others were indicted for entering the abbot's close and cutting down his timber to the value of £60,³⁸ which indicates probably an organized demonstration in claim of common rights. In this dispute the name of Henry Grindecobbe, which later became so prominent, occurs as a pledge.³⁹

Soon after the abdication of Edward II, in October 1326, the men of St. Albans began to bind themselves together with oaths, and after Epiphany rose against the abbey.⁴⁰ On 23 January some of the townsmen met the citizens of London, and entered into a solemn compact of mutual help.⁴¹ The upper class in St. Albans are said by the monastic chronicler to have connived at this embassy⁴² rather than joined in it; but this is hardly consistent with what we know of Benedict Spichfat and what we suspect of Gilbert de Hertford, one of the richest men in the town.⁴³ Although the richer inhabitants were probably slower in action than the others, the townsmen seem to have shown great solidarity at this time. The only case of independent action was on 25 January, when twelve 'of the richest' went to the abbot and begged him not to mention his difficulties to the Earl of Lancaster, who was passing through and resting at the abbey on the way to London.⁴⁴ This was so obvious a precaution that the twelve may well have acted for all.⁴⁵ On 28 January the villeins presented their supplication to the abbot. They asked, first, that the abbot should deliver to them the charters of their liberties, by which they were made as free as any borough and burgesses might be; liberties which they had enjoyed from the Conquest, until debarred by the abbot and his predecessors, as the charters themselves and Domesday Book testified. Further, they sought the right to elect two

³³ Chan. Misc. bdl. 62, file 1, no. 15.

³⁴ Walsingham, *Gest. Abbat.* (Rolls Ser.), ii, 154-5.

³⁶ *Ibid.*

³⁷ Lay Subs. R. Herts. 120, no. 11.

³⁹ *Ibid.* m. 3 d.

⁴⁰ Walsingham, *op. cit.* ii, 155 et seq.

⁴¹ Lay Subs. R. Herts. bdl. 120, no. 11.

⁴⁵ *Ibid.* The chronicler puts another colour on the matter.

³³ *Ibid.*

³⁵ Chan. Misc. bdl. 62, file 1, no. 15.

³⁸ Assize R. 331, m. 1.

⁴¹ *Ibid.*

⁴² *Ibid.*

⁴⁴ Walsingham, *op. cit.* ii, 156.

SOCIAL AND ECONOMIC HISTORY

burgesses to send to Parliament, like other boroughs, and to answer before the justices, as they had been used, by twelve burgesses of the vill, without the interposition of foreigners. They asked that twelve burgesses should keep the assize of bread and ale as of old. Then they came to recent troubles; they required the right of common in the abbot's woods and fisheries (and for this they appealed to Domesday Book),⁴⁶ the right to have their hand-mills, with damages for the recent suppressions, and the right to have all executions in the town made by the bailiff of St. Albans instead of the bailiff of the liberty.⁴⁷

These demands were presented 'at prime'; the chapter deliberated, and the abbot gave verbal answer, presumably to a deputation, while the crowd was gathering and waiting outside. The abbey had been in a state of defence since 22 January; the monks gathered in the church and their men-at-arms stood to their posts. By the sixth hour it was known in the town that the abbot refused to give a written answer. The townsmen made an assault upon the Holywell gate, but were driven off. The town leaders apparently restrained their fellows, acting possibly on advice from London, where they must have had agents, as they retained serjeants of law in these next days. There also came down from London a royal proclamation which had some effect in sending the townsmen home. Meantime at St. Albans six of the 'better' townsmen went to the abbot to propose a conference; he agreed that each side should send procurators to a meeting in the cathedral church of St. Paul, in London, on 23 February. The townsmen procurators must have gone to London at once, for by 8 February they had obtained⁴⁸ a royal writ commanding the abbot and his bailiffs to abstain from disquieting the burgesses in their liberties, if they were entitled to them.⁴⁹ Another writ was issued to the barons of the Exchequer for a search to be made in Domesday Book.⁵⁰

At the meeting the parties agreed to elect twelve worthy lawyers and knights of the neighbourhood on each side to arbitrate. Quickly chosen, they went to work at once, and their meetings were attended by three nobles, sent by the king to make a report to the Council. On 6 March they held their last meeting in St. Alban's Church. It had been proved that the men of St. Albans were called 'burgenses' in Domesday.⁵¹ The charter of Henry II was read, and the villeins appealed to the word 'burgus' applied to their town to be confirmed as burgesses. The arbitrators seem hardly to have hesitated in drawing up their award, and adjourned for a final discussion with the king's Council on 10 March.

On this same day, at St. Albans, the townsmen gathered again to attack the church, swarming round the abbey, shouting and reviling the monks as 'ribald thieves.' They were easily dispersed by the men-at-arms, but for five nights the abbey was surrounded by bands some eighty strong, and the monks expected the worst, but were determined to defend their church to the last.

The crisis ended when news came from London. On the 10th the three representatives of the abbot had agreed to the arbitration, which was embodied in an indenture. Twenty-four of the 'most faithful' burgesses,

⁴⁶ Walsingham, *op. cit.* ii, 157.

⁴⁷ *Ibid.* 157-8.

⁴⁸ 'Not sparing expense,' says the chronicler. Walsingham, *op. cit.* ii, 161.

⁴⁹ *Ibid.* 162.

⁵⁰ *Ibid.*

⁵¹ *Ibid.* 163.

A HISTORY OF HERTFORDSHIRE

among them Benedict Spichfat and Henry Grindecobbe, were to perambulate the bounds of the vill, which was recognized as a borough ; all the tenements being burgages and all the people burgesses.⁵² They were to elect two burgesses to send to Parliament, and their juries were to be composed of townsmen only ; moreover, they were only to come to the hundred court when impleaded by writ. The assize of bread and ale was to be kept by burgesses, and the town bailiff alone was to make executions. The only concession to the convent was that the burgesses should grind at the abbot's mills. To this the burgesses set their seals on 12 March,⁵³ with imaginable alacrity. But the chapter protested and refused until the king ordered them to seal likewise. On 14 April the indenture received confirmation by Letters Patent.⁵⁴

The townsmen were thus established as burgesses. They improved the victory by demanding common rights in Barnet Wood, as well as rights of fishing and rights of taking game, all of which the abbot conceded.⁵⁵ But they were charged with breaking the charter by making and maintaining eighty hand-mills.⁵⁶ As to this there is no evidence. For five years⁵⁷ the men of St. Albans lived under the new conditions.

Abbot Hugh died before September 1327,⁵⁸ and Richard of Wallingford, his successor,⁵⁹ cannot have settled down in St. Albans much before the early summer of 1328.⁶⁰ He must have known that he was embarking on a struggle with the burgesses when he began to exercise his spiritual jurisdiction in the town. He cited one John the Marshal, apparently an innkeeper, and one of the most considerable burgesses, on a charge of adultery.⁶¹ On 13 May 1328 his officer went to arrest the man, was attacked, struck back, fought his way to the market-place, and fell there under the blows of the townsmen. Meantime John the Marshal had died of his wound. Both sides thus had a *casus belli* ; but the men of St. Albans took the offensive, and indicted⁶² the abbot before the coroner. The burgesses obtained a royal mandate, in pursuance of their charter, that no foreigners should be joined with them on their jury before the justices.⁶³ But this precaution did not help them, for when the time came the abbot and his servants were acquitted by the verdict of three other hundreds—an infringement of the borough charter.⁶⁴

Then, in November 1328, the abbot made a counter accusation against the townsmen of the death of his man. At the ensuing conference the abbot was represented by many lawyers and others ; the burgesses only by one serjeant of the King's Bench and by a notable Londoner, Simon Francis, then a sheriff and later mayor.⁶⁵ But the assembly broke up over the first subject of debate, the question of hand-mills.⁶⁶

No Abbot of St. Albans with a 14th-century conscience could have any other object than the destruction of the borough charter. The same process occurred in such other monastic towns as Bury St. Edmunds, Sherborne and elsewhere. Abbot Richard must have been well able to see

⁵² Walsingham, op. cit. ii, 166-70.

⁵³ Ibid.

⁵⁴ *Cal. Pat.* 1327-30, p. 93.

⁵⁵ Walsingham, op. cit. ii, 175.

⁵⁶ Ibid. 176.

⁵⁷ Ibid. (see below). Seven years, as stated on p. 215, is an exaggeration.

⁵⁸ *Cal. Pat.* 1327-30, p. 167.

⁵⁹ Ibid. 184.

⁶⁰ Ibid. 272.

⁶¹ Walsingham, op. cit. ii, 216-17.

⁶² Ibid. 218, 221.

⁶³ Ibid. 219.

⁶⁴ Ibid.

⁶⁵ Ibid. 222.

⁶⁶ Ibid.

SOCIAL AND ECONOMIC HISTORY

how time and experience were playing into his hands. The townsmen had appointed borough officials and instituted a common chest, with the accompaniment of heavy collections from the greatest to the least, for their common purposes,⁶⁷ such as the payment of the members. These collections are described later as unendurable taxes⁶⁸; and no doubt the men of St. Albans felt their elevation to the burgh-ship rather as increased liability than as increased prosperity. Like a wise man, Abbot Richard apparently let experience accumulate for some years. During this time, too, the attitude of the king to the borough must have changed, for when the abbot began to act he received the royal support strongly enough. In September 1331 the townsmen were indicted before the justices of Traylbaston for the extortion of a charter. In due course a royal writ ordered the justices to inquire,⁶⁹ and, probably in connexion with these proceedings, the king ordered a report to be made on the whole proceedings of 1275 and 1313.⁷⁰ The abbot further charged the burgesses as a body with having besieged the abbey, and accused individuals of conspiracy and breaches of the peace.⁷¹ Eighteen confessed their guilt, and forty-two were judged guilty by the verdict of the country.⁷² The final charge of withdrawing suit to the abbot's corn and malt-mills was preferred first against thirty-six burgesses. On the jury finding that the abbot was seised of the right in the time of Henry III the king issued a 'praecipe' to the townsmen that they should restore the suit.⁷³

These cases were followed by another similar series, in which judgement was given for the abbot. Some of the burgesses made claim to their hand-mills, but they seem to have been unsuccessful.⁷⁴ The litigation was very expensive, and this apparently was the cause of the destruction of the commune. Representatives came to the abbot and offered the following terms: the villeins should surrender their charters, should pay 200 marks as damages within five years, and give security; they were to hold the malt-mill at farm for £48 a year and to recognize due suit.⁷⁵ These terms were accepted; they represent indeed the complete victory of the abbot. The charters were handed in, the indenture, the confirmation by Letters Patent, and the charter of Edward II enforcing the privilege of Henry III.⁷⁶

The king's Council authorized the concordat. But the agreement was made so secretly that the 'community of the town' would not believe then or later that the charters had been surrendered.⁷⁷

However, many of the villeins were evidently frightened; they brought in their querns, their seal and keys and common chest. The abbot took obligations⁷⁸ from many of them, of which an example has survived. In the Trinity term 1332 Gilbert de Hertford, Richard de Tring, William son of John the Marshal and many others came into the king's court at Westminster, and caused their charter to be enrolled there; they bound themselves to grind their corn and full their common cloths at the abbot's mill, and to pay all dues as well in these matters as in stallage and tolls, for which distraint

⁶⁷ Walsingham, *op. cit.* ii, 215.

⁷⁰ Chan. Misc. bde. 62, file 1, no. 15.

⁷² Ibid. ⁷³ Ibid. 237.

⁷⁸ Ibid. The indenture was surrendered by Adam the Usher and others 13 April 1332 (Close, 6 Edw. III, m. 26 d.).

⁶⁸ Ibid. 248.

⁷¹ Walsingham, *op. cit.* ii, 229, 233-7.

⁷⁴ Ibid. 248.

⁷⁵ Ibid. 250.

⁷⁷ Walsingham, *loc. cit.*

⁷⁸ Ibid. 255-6.

A HISTORY OF HERTFORDSHIRE

might be made, nor would they ever claim these rights in future.⁷⁹ In 1341 the jury indicted the abbot and others, both monks and laymen, on the ground that in 1331 they had imprisoned William son of John the Marshal, and John his son and many others, until they promised to give these bonds under penalties of 20 marks or £10.⁸⁰

One or two of these men are notable. Richard de Tring had been one of the pledges of Robert de Limbury⁸¹; perhaps he was important enough to be worthy of a specific bond. Gilbert de Hertford was one of the richest burgesses; prosperous too was William son of John the Marshal, presumably the victim of about 1328.⁸² If these men represent the leaders of the burgesses, the movement for the charters had money behind it.

The most remarkable part of the affair is the villein organization. If one employs a superficial likeness, one may compare it with that of a modern strike. The paid leaders conducted it with inspiration from London. London was closely connected with the solid union of the townsmen in 1327.⁸³ In 1338 it was a sheriff and future mayor who appeared for them. To whom in London the villeins applied for advice we cannot know, but there is strong indication that the Londoners deliberately helped the deliberate attempt of the men of St. Albans. We know from the history of Lollardry the capacity of mediaeval popular organizations to disappear. How much is certain as to the working of the Peasants' Revolt or of the Lollards?

The villein organizers were backed by a common fund. The commune eventually sank under the charges and collections for common business and 'for remunerating their helpers and organizers' (*fautoribus et conductoribus*).⁸⁴ The whole story shows the villeins as astonishingly able for organized action.

Political consciousness was the result, but the motive was economic. To be free men or free burgesses was necessary to merchants and craftsmen. From this need flow all the demands of the townsmen: the appearance of the town as a community before the justices, the common fund and council and officials⁸⁵; above all, the representation by two members of Parliament.

The economic claim has another interesting aspect. The villeins wanted much that applied to a rural community—the rights of common and the grinding of corn—and these are the articles which were common to Barnet and Watford. Industrial and commercial questions were also involved in the question of status, but these were raised only at St. Albans. The fulling of cloth is one instance. Payment of tolls and stallage were probably also disputed at St. Albans; in 1332 the burgesses bound themselves to pay.

The failure of the burgesses, like their success, was a matter of money. The case of St. Albans helps to show why other tenants of the abbey were equally at variance with the abbot.

Wherever the tenants of the abbey were strong enough they struggled with the abbot. At Watford, in 1313, the tenants 'forcibly' fished in the abbot's private waters, and were duly sued for it.⁸⁶ In 1300 a bad affair occurred at Barnet. The abbot charged his tenant with throwing down his ditch and burning his hedge. One defendant said that the abbot had inclosed

⁷⁹ Chan. Misc. bdlc. 64, file 5, no. 198.

⁸⁰ Assize R. 337, m. 7.

⁸¹ See above.

⁸² Lay Subs. R. Herts. bdlc. 120, no. 11; cf. Assize R. 337, m. 7.

⁸³ See above; Walsingham, op. cit. ii, 155, 222.

⁸⁴ Walsingham, op. cit. ii, 215.

⁸⁵ Ibid.

⁸⁶ Pat. 7 Edw. II, pt. i, m. 7 d.; Walsingham, loc. cit.

SOCIAL AND ECONOMIC HISTORY

the common pasture. This case illustrates the way in which the townsmen in all except the largest towns, and even there to some extent, were at one with the country men.

The most unusual feature of the country population in 1086 is the 'fan-shaped' distribution of socmen from Lilley to Hoddesdon.⁸⁷ Of this element, under this particular name at least, it may be said at once no trace can be found in later times. The people were freemen or villeins, in one or other of the economic subdivisions of that class. For example, at Caddington, in 1222, there were twenty-six free tenants, thirty tenants who held freely of the demesne, thirteen tenants holding of the demesne in villeinage, eight *cottarii* with five tenements, and eight tenements held of the new assart, besides one free tenement cut up into eight holdings.⁸⁸ All the freeholders paid rent and ploughed twice in each season, besides hoeing and reaping thrice a year,⁸⁹ which was quite a typical early form of free service.

But commutation among the freemen came quickly. At Aldenham, not long after this time, the freeholders paid rent only.⁹⁰ At Newsells, at the other side of the county, the free tenements were entirely arrented in 1249,⁹¹ and this, of course, became usual. It is exceptional when the free tenants find men to reap the lord's corn, as two out of twenty-eight did at Shenley in 1276.⁹² Many of these twenty-eight did not even owe suit of court,⁹³ and lords began to bind their tenants to this service by deed.⁹⁴

The classification of the unfree at Caddington gives first the thirteen holding in villeinage of the demesne, half virgaters or less.⁹⁵ The service of the half virgater is thus described :

He has to work twice a week for the whole year, except Christmas, Easter and Whitsun ; and in each sowing season to plough $1\frac{1}{2}$ acres, or if he has no plough to do two works. If he ploughs he is quit of one work at that time in each week. He must also plough one day as love earth in each season. Each virgate which does not plough ought to prepare six quarters of malt or to pay 6*d.*, and it shall be quit of six works, and shall have fuel for the malt of the lord ; those who do not plough shall do the service of carrying five capons or ten hens to London at Christmas.⁹⁶

This was a true villein tenure, hardly touched by commutation.

The next class, the eight *cottarii*, illustrate the criss-cross economic divisions of the villeinage, for they seem to have been richer than the others ; some of them held a whole virgate.⁹⁷ The distinction probably rested on the heavier week work ; at a time when week work was the mark of villeinage a man who did three works a week was naturally deeper in servitude than the man who did two.

[The cottarius] has to work thrice a week from Michaelmas to 1 August, except Christmas, Easter and Whitsun, and from 1 August to Michaelmas every day but Saturday.

They owe eight carryings of loads a year to London or elsewhere. They also pay garsavese [pannage], viz. $4\frac{1}{2}$ *d.* for a virgate which does carrying on foot, and if they do not . . . they give pannage by custom for every pig above one year, and they pay $7\frac{1}{2}$ *d.* land gavel and woodsilver, and 1 qr. oats for fodder corn, and seed corn for 1 rood.⁹⁸

This tenure has the usual heavy harvest work, and, like the first class, has the Hertfordshire carrying service. These services may be compared with those of Aldenham :

These are the customs due from each virgate. Each plough . . . ploughs thrice a year without food [from the lord]. If the lord wants more ploughs, he must find them food. Each man with a plough owes

⁸⁷ *V.C.H. Herts.* i, 266.

⁸⁸ *Dom. Bk. of St. Paul's* (Camd. Soc.), 1 et seq.

⁸⁹ *Ibid.* ⁹⁰ *Add. Chart.* 3739.

⁹¹ *Chan. Inq. p.m. Hen. III,* file 8, no. 12.

⁹² *Rentals and Surv. R.* 296.

⁹³ *Ibid.*

⁹⁴ *Anct. D. (P.R.O.), A* 6050.

⁹⁵ *Dom. Bk. of St. Paul's* (Camd. Soc.), 1 et seq.

⁹⁶ *Ibid.*

⁹⁷ *Ibid.*

⁹⁸ *Ibid.*

A HISTORY OF HERTFORDSHIRE

one work. Each man who has a horse must harrow without food twice. Each man must hedge [*sepire*] 3 virgates. Each virgate must carry two loads of wood . . . and gives two hens. At Michaelmas and Advent each man must [*?give*] 24 sheaves. Each virgate owes sixteen eggs. Each man must hoe twice without food, and reap once, and send from each house one man for the hay. Each virgate carries two loads of hay, and at the reaping they have of the lord [*food and 6d.*]. Each virgate owes eight men at two boondays without food, and at the dry boonday four men, and at the great boonday one servant. If the lord wants men at reaping, the virgate must find a man to reap at the lord's food. Each man finds one man to bind. Each virgate carries eight loads of grain . . . and six men work once a week. Each virgate owes 6s. 4d. at four terms.⁹⁹

At Aldenham, except in the case of the six odd men, the week work is conspicuous by its absence. It is represented probably by the 6s. 4d. Possibly this early command of money by the men of Aldenham is due to their proximity to London. Even then their corn may have found markets at Watford or at Barnet.

The commutation of services was beginning throughout Hertfordshire in the 13th century; so much is certain, but generalizations are difficult and dangerous. The following statement may perhaps approximately cover the facts. By the end of the 13th century commutation of the week work had taken place in the southern part of the county; the case in point at Aldenham has been cited. In 1276 the villeins of Shenley did no week work (except in harvest), but paid a rent.¹⁰⁰ By 1291 neither the villeins nor the coterelles of Langley did week work.¹ In 1297 a new stage had been reached; while the ploughing custom was still performed, the harvest works were sold to the customary.² Beyond the southern area commutation of week work is found distributed rather fantastically.

In some cases it seems to have taken place in centres of population. All services were apparently commuted at Hemel Hempstead as early as 1222.³ At Sawbridgeworth about 1263 'the homage' paid £6 16s. in money, besides their uncommuted hens, capons, fodder corn and other services.⁴ By 1271 the villeins and two cotmen paid £5 12s., and apparently nothing further.⁵ The men of King's Walden had attained the same position in 1276.⁶

At Hitchin in 1268 the serfs paid £7 5s. and did ploughing works⁷; this looks like commutation of the week work and some of the other dues. But there was another group of villeins there who still did week work, and the boondays and carryings were still performed.⁸ In 1290 the one class of serfs seems to have commuted their services entirely, while the others, now twenty-four in number, still did carrying service and two works a week.⁹ But the commutation of the week work was taking place even on small and rural manors. At (Little) Gaddesden in 1284 the customary paid 3 1s. 10d. in rent, and did heterogeneous works, ploughing 22½ acres, harrowing one day each in Lent, tossing and carrying hay, hoeing for one day, doing two boondays, and giving fowls, eggs, loaves and carrying service.¹⁰

At Wigginton the villeins paid 30s. 7d. and performed various services.¹¹ The men of Munden Furnival (Great Munden) were apparently free from week work in 1290, but were probably still ploughing and carrying and giving autumn boondays.¹²

⁹⁹ Add. Chart. 3739.

² Mins. Accts. bdle. 40, no. 740.

⁴ Ibid. file 29, no. 2, m. 9.

⁷ Ibid. 53 Hen. III, no. 43.

¹⁰ Chan. Inq. p.m. Edw. I, file 38, no. 8.

¹⁰⁰ Rentals and Surv. R. 296; cf. R. 279.

³ Chan. Inq. p.m. Hen. III, file 42, no. 1.

⁵ Ibid. file 42, no. 6.

⁸ Ibid.

¹¹ Ibid.

¹ Ibid.

⁶ Ibid. 5 Edw. I, file 17, no. 16.

⁹ Exch. Proc. bdle. 144, no. 133.

¹² Ibid. file 57, no. 9.

SOCIAL AND ECONOMIC HISTORY

In these places all the customary tenants seem to have achieved the same degree of commutation. But the process went on by individual agreement with the lord, as well as by the arrangement of the whole vill. At Codi-cote, a manor of St. Albans, the reeve came into court in May 1247 and paid 2s. gersuma for 9 acres, for which he was to pay 30d. at the four terms of the year for the 'works which used to be done for it, viz. one work in each week'; the commutation was to be at the will of the cellarer.¹³ The reeve did not immediately find many imitators,¹⁴ but forty years later the community was awake to the advantages of commutation.

In 1248 at Tyttenhanger (which belonged to the same church) T. Baker took 6½ acres at a rent of 20d. for all service, except one man for the great boonday.¹⁵

From Codicote comes an instance of commutation *en masse*. In 1293 the whole vill granted to the lord that it would do the two usual boondays at Bradeway, as it did in the land of Cisseverne, for which they had before agreed to give certain money; during the term of the lord abbot the payment should cease, but afterwards the money was to be paid again, as had been agreed.¹⁶ This case speaks for itself, but it is not a very common one.

The ordinary services were still only partially commuted forty years later. In many courts, between 1330 and 1336, villeins came to obtain a verdict, apportioning the due service on lands acquired.¹⁷ These were generally small pieces and plots, fractions of a former tenement, and most carried rent and a few outstanding services.

Below complete commutation and the commutation of week work is the stage where the works of the villeins are valued in money. How much actual service this covers is often uncertain. At Newsells in 1239 the villein customs were worth 12 marks, their hens and eggs 3s.¹⁸⁻²⁰ We may feel sure that the hens and eggs were actually rendered into the reeve's hands, but such certainty does not extend to the works.

At Hunsdon, ten years later, the customary works were worth 44s. 2d.²¹ In 1262 the works at Meesden were valued at 20s. 8d. from 29 September to 1 August; during August and September at 16s.²² At Sacombe, as late as 1282, the customs, pannage, cocks and hens are valued.²³

Finally come the instances where the services remained uncommuted. At Therfield they may well have been the same in 1171 as they were in 1271.²⁴ Possibly this case is due to the absence of the lord and the remoteness of the village. At Wyddial, in 1284, the customary tenants did 488 works between 29 September and 1 August and 120 works in the remaining eight weeks.²⁵ Much later, in 1324, the services at Watton are detailed in a way that suggests that they were performed.²⁶ At Walkern, in 1313, ploughing and 960 works and 240 autumn works were due.²⁷ At Greenbury in 1325 the jury gave a full account in court of the customary works done.²⁸ In 1341 the four customary tenants at Reed still appear to have been doing their weekly works.²⁹

¹³ Stowe MS. 849, under date quoted.

¹⁴ *Ibid.*

¹⁵ Caledon D. Ct. R. Tyttenhanger.

¹⁶ Stowe MS. 849, under date quoted.

¹⁷ *Ibid.*

¹⁸⁻²⁰ Chan. Inq. p.m. Hen. III, file 8, no. 12.

²¹ *Ibid.* 33 Hen. III, no. 70.

²² *Ibid.* Hen. III, file 27, no. 20.

²³ *Ibid.* 11 Edw. I, no. 49.

²⁴ *Chart. Ramsey Abbey* (Rolls Ser.), i, 45-8.

²⁵ Chan. Inq. p.m. Edw. I, file 38, no. 4.

²⁶ *Ibid.* 17 Edw. II, no. 39.

²⁷ *Ibid.* 6 Edw. II, no. 58.

²⁸ Ct. R. (Gen. Ser.), portf. 177, no. 33.

²⁹ Chan. Inq. p.m. Edw. III, file 64, no. 20.

A HISTORY OF HERTFORDSHIRE

About the end of the 13th century, then, it seems safe to say that most of the Hertfordshire lords were receiving rent and autumn services and minor dues from their villeins. This implies the hiring of some regular farm labour from Michaelmas to the end of July; but during the harvest months the villeins would still come more or less willingly to the lord's demesne strips and meadows. But the steward was often willing to take money in lieu of the harvest work; and from the beginning of the 14th century an opportunist commutation of the harvest work set in. The steward would sell the autumn works to the custumaries, if both parties wished it. Thus at Langley in 1307-8 the custumaries paid 68*s.* 4*d.* for their autumn works and 10*s.* 9*d.* for their three boondays.³⁰ As the lord's autumn expenses were 76*s.* 1½*d.*,³¹ he made a profit. In 1312-13 the custumaries performed their autumn boonday, but redeemed their reaping (which the steward notes as unusual), besides their threshing and other autumn works.³² In 1316-17, after the year of disaster, the villeins bought very few autumn works,³³ and in 1324 some did the boonday and most redeemed their harrowing, but only two and a half reapings were sold, while thirty-eight men came in person to reap.³⁴

The custumaries of Temple Dinsley seem to have bought up all their harvest works, except the ploughing custom, in 1312-13.³⁵ At Stevenage, in 1308, the custumaries and the cotters reaped 293 acres, against 33 acres reaped by hired labourers; but the threshers were hired, and 806 harvest works were sold.³⁶

Later the commutation of the harvest works became more complete and more regular. In 1338-9 the threshing, reaping, binding and hoeing were all done by hired labour,³⁷ and at Ashwell, about the same time, the villeins only did the hoeing and stacking of the hay.³⁸ Standon was still exceptional. In 1347 the custumaries were still doing two weekly works, reaping, mowing and ploughing, and there were two who did one work a week.³⁹

Thus long before the Black Death agricultural labour was undergoing a change.

A class of hired labourers was growing up, whose mere existence told against the continuance of labour service on the demesne. When times were not too hard both the lord and the villein found their interest in commutation. It was prosperity that was lifting the Hertfordshire villein. There are certain rather vague indications of this, besides the facts of commutation. The activity of the villeinage in letting, transferring and acquiring land is witnessed by the Court Rolls.⁴⁰ The same impression is given by the rolls of Codicote from the time of Henry III to that of Edward II,⁴¹ in the rolls of Croxley,⁴² of Ashwell,⁴³ and indeed in all those inspected. These transactions in land cost money, and could not have been indulged in unless they brought profit. One may almost say that there was some competition

³⁰ Mins. Accts. bdle. 866, no. 17.

³¹ *Ibid.*

³² *Ibid.* no. 19.

³³ *Ibid.* no. 21.

³⁴ *Ibid.* no. 29.

³⁵ *Ibid.* bdle. 865, no. 13.

³⁶ *Ibid.* bdle. 870, no. 20.

³⁷ *Ibid.* bdle. 866, no. 5.

³⁸ *Ibid.* bdle. 862, no. 6.

³⁹ *Ibid.* bdle. 869, no. 8.

⁴⁰ One Abbot of St. Albans (1260-90) attempted to enforce forfeiture of the purchase on villeins buying free land; of course this came to mean merely a fine (Walsingham, *op. cit.* i, 453).

⁴¹ Stowe MS. 849.

⁴² Add. MS. 6057.

⁴³ Ct. R. (Gen. Ser.), portf. 176, no. 127.

SOCIAL AND ECONOMIC HISTORY

for land among the customary tenants. The rolls and accounts give no evidence of a deficiency of tenants until about the year 1315.

While these changes incident to tenure were going on the personal condition of the villein was changing. This shows itself, in the first place, in the occasional separation of tenure and status. As early as 1222 we find a reeve at Caddington, who held a free tenement.⁴⁴ At Codicote, in 1278, two tenants exchanged their tenements, one of which was free, so that this one should do villein service and the other do free service.⁴⁵ Either this tenant was a villein holding freely or he was dealing with his free land in a way which the king's courts might not have approved. The change must have been fairly recognized by 1300,⁴⁶ or a citizen of London would not have been holding villein land in Ashwell.⁴⁷ In 1333 land in Codicote was held in villeinage, 'in whatever hands it might be.'⁴⁸

The right of the villein to demise his land seems to have been generally recognized, subject to the buying of licence from the lord.⁴⁹ Moreover, the wider right of making a surrender of land to the use of a person named was developed early, and it became common at Codicote about 1260.⁵⁰ Such conveyances became quickly as elaborate and elastic as free men's deeds. In 1295, at Sawbridgeworth, R. Pete surrendered his land 'to R. atte Brynehe, who pays 2s. . . . so that Richard shall do due service . . . and shall give R. Pete $\frac{1}{2}$ quarter of wheat and $\frac{1}{2}$ quarter of beans all his life,' at Michaelmas and All Saints.⁵¹ A contingent reversion was created on a surrender at Ashwell in 1299.⁵²

These elaborate transactions needed record. In 1274 a villein 'enfeoffed,' as the roll has it, by the lord, paid 2s. *pro rotulo habendo*.⁵³ Seven years later one Walter atte Strete paid 2s. for licence to search the rolls as to his title to a plot of land.⁵⁴ There are many cases of villeins with charters, the possession of which, to a legal purist, might have been a presumption of freedom. The earliest of these is from 1296.⁵⁵

The villeins were evidently growing more independent or insubordinate; this seems to be on the increase after about 1320. For example, the men of Codicote began to have difficulties with the Abbot of St. Albans exactly like those of the men of St. Albans. From 1330 there are many presentments of those who have not ground at the lord's mill.⁵⁶ In the same year the lord granted John Dolitel a hand-mill for grinding oats, to be held in villeinage at the rent of 2d. a year.⁵⁷ Some of the tenants used hand-mills against the lord's prohibition,⁵⁸ and the cases connected with grinding became a recurrent item in the Court Rolls.

At Codicote from about 1288 the lord occasionally took specific recognitions of liability to tallage from new tenants.⁵⁹ Tallage was paid on the manor of Langley apparently every year,⁶⁰ but the obligation was very

⁴⁴ *Dom. Bk. of St. Paul's* (Camd. Soc.), 1 et seq.

⁴⁵ Stowe MS. 849, under date quoted.

⁴⁶ cf. the rules of Abbot Roger of St. Albans, 1260-90 (Walsingham, op. cit. i, 453).

⁴⁷ Ct. R. (Gen. Ser.), portf. 176, no. 128.

⁴⁸ Stowe MS. 849, fol. 50 et seq.

⁴⁹ Add. MS. 6057; Stowe MS. 849.

⁵⁰ Stowe MS. 849, fol. 50 et seq.; cf. also Ashwell Ct. R. (Gen. Ser.), portf. 176, no. 127.

⁵¹ Ct. R. (Gen. Ser.), portf. 178, no. 24.

⁵² *Ibid.* portf. 176, no. 128.

⁵³ Stowe MS. 849.

⁵⁴ *Ibid.*

⁵⁵ Ct. R. (Gen. Ser.), portf. 178, no. 24; cf. also Add. MS. 6057; Ct. R. (Gen. Ser.), portf. 177,

no. 33.

⁵⁶ Stowe MS. 849, fol. 50 et seq.

⁵⁷ *Ibid.*

⁵⁸ *Ibid.*

⁵⁹ *Ibid.*

⁶⁰ Mins. Accts. bdlle. 866, no. 17, 19, 21, 29.

A HISTORY OF HERTFORDSHIRE

irksome, especially in the hard times about 1315.⁶¹ The impost was at the will of the lord, and must have been levied on the whole estate of the villein, both personal and real, for about 1326 the men of Redbourn were assessed to a tallage; each villein holding half a virgate paid sums varying from 12*d.* to 6*s.* 8*d.*⁶² The remaining villeins paid from 6*d.* to 40*d.* This arbitrary assessment raised a rebellion among the tenants, who offered a composition of 40*s.*, which the abbot refused. The villeins thereupon forged a charter purporting to be of pre-Conquest date, but with a natural ingenuousness worded it in their own English.⁶³ This charter did not help them, for they were tallaged again soon after, and forced, first to recognize that they were villeins and tallageable, and then to pay the tax.⁶⁴

Cases of fugitive villeins are not very rare even in the 13th century, for as commutation for services increased there was less necessity to bind the tenant to the soil. In one court at Codicote in October 1239 there is entered 2*s.* 'of a fugitive,' and 1 lb. of pepper paid by a villein for permission to live outside the lord's liberty.⁶⁵ At Tyttenhanger in 1267 'Robert son of Robert Adger, native of the lord, remains at London, and William his brother at St. Albans, John son of Stephen is at London or elsewhere, Stephen son of Henry the Porter at London, Philip his brother near Staines.'⁶⁶ Cases occur in which the villein fled *cum omni sequela sua*.⁶⁷ About the same time similar instances are to be found at Codicote,⁶⁸ but they become more numerous after about 1330. In 1331 the wife of one fugitive paid 12*d.* to hold her husband's lands,⁶⁹ and John Haleward gave six capons for licence to go to the 'clerical schools.'⁷⁰ In 1335 Robert the Smith took licence to serve where he would for the next twelve years.⁷¹ In 1340 Hugh de Thickenhay having fled, his wife took his lands, although they were waste.

The value of arable land in Hertfordshire changed very little from the middle of the 13th to the middle of the 14th century. The values given are drawn from the demesne estates, on which the valuations are probably nearer to the economic worth than those of tenant land. Position and the nature of the soil must, doubtless, have had some influence on the value, but this is not very marked, and it is of interest to note that the values of the 13th century show more variation than those given after 1315. In 1313 arable was worth 6*d.* an acre, both in Hormead⁷² and in King's Walden.⁷³ In the north of the county at Standon the acre was worth 6*d.* in 1263⁷⁴ and 4*d.* at Hitchin in 1268.⁷⁵ Between 1280 and 1290 the value was 3*d.* at (Little) Gaddesden and Wigginton⁷⁶ (the lowest rate mentioned) and 6*d.* at Wyddial.⁷⁷ It was 4*d.* at Stevenage in 1275.⁷⁸ The zone of high prices extends from Sawbridgeworth to Langley. In 1276 some of the arable at Shenley was worth 6*d.* an acre.⁷⁹ In 1291 380 acres were still worth 6*d.*, and 450 acres at Langley 5*d.* each.⁸⁰ At Sawbridgeworth the acre was worth 8*d.*⁸¹ (the highest sum met with in the county), and in 1302-3 the arable of Pishobury, in the same vill, was valued at 6*d.* to 8*d.* an acre.⁸² But apart

⁶¹ cf. the agitation against tallage.

⁶² Walsingham, op. cit. ii, 263.

⁶³ Ibid. 262.

⁶⁴ Ibid. 263.

⁶⁵ Stowe MS. 849.

⁶⁶ Caledon D. Ct. R. Tyttenhanger.

⁶⁷ Ibid.

⁶⁸ Stowe MS. 849.

⁶⁹ Ibid.

⁷⁰ Ibid.

⁷¹ Ibid.

⁷² Chan. Inq. p.m. 7 Edw. II, no. 26.

⁷³ Ibid.

⁷⁴ Ibid. Hen. III, file 27, no. 5.

⁷⁵ Ibid. 53 Hen. III, no. 43.

⁷⁶ Ibid. Edw. I, file 38, no. 8.

⁷⁷ Ibid. no. 4.

⁷⁸ Ibid. 3 Edw. I, no. 10.

⁷⁹ Rentals and Surv. R. 296.

⁸⁰ Ibid. R. 279.

⁸¹ Chan. Inq. p.m. Hen. III, file 29, no. 9, m. 2.

⁸² Rentals and Surv. portf. 8, no. 43.

SOCIAL AND ECONOMIC HISTORY

from these high figures an average over the county would perhaps give 4*d.* an acre as the usual value.

The general trend of value seems to be higher in the southern part of the county. This was the region where commutation was earliest, and it is tempting to regard this as more than a coincidence; even to seek as the efficient cause a connexion with London and its markets.

After about 1315-18 the result would be more definite, the 4*d.* rate became almost the rule, and there are very few advances above it. It held at Great Wymondley and Weston in 1318,⁸³ at Benington in 1324,⁸⁴ and at King's Walden from 1329 to 1337;⁸⁵ at Kimpton in 1337⁸⁶ and at Reed in 1341.⁸⁷ During the same period the acre was worth 3*d.* at Watton and Little Wymondley⁸⁸ and only 2*d.* at Hoddesdon.⁸⁹

These figures suggest a fall in the value of arable land; and this is confirmed from other sources, for murrain and droughts had scarcely left the cultivators the means to farm the arable. In 1341 a large part of it lay unploughed at Hatfield, Totteridge, Datchworth and Welwyn, and in the north-east at Barkway, Barley, Reed, Cottered, Buckland, Wyddial, 'Alflade-wyk' (Layston), Great and Little Hormead and Meesden.⁹⁰ At Braughing, Royston and Therfield the fields were in the same condition.⁹¹ Ware and Hertford and their neighbourhood seem to have escaped, but Benington, Westmill, Aspenden, Walkern, Wakeley, Rushden and Wallington were all half desolate. So, too, were Sandon, Ashwell, Bygrave and Clothall.⁹² What the condition of the rest of the county was is not known,⁹³ presumably it was not much better.

Under such circumstances land values naturally fell. It is noticeable that from about this time there is mention of inclosed arable land, in which the land in the common fields is rated as much less valuable. In 1327 at Codicote the acre of villein land in the open fields was worth 4½*d.* and 6*d.* to 8*d.* an acre inclosed.⁹⁴ Inclosures were a possible remedy for agricultural depression. To tie the culture of the fields to the well-being of the plough-beasts of the whole village was obvious folly in the years of murrain.

The extent of meadow-land in Hertfordshire is small, and its value proportionately high; it was worth 2*s.* an acre at Standon in 1296,⁹⁵ at Hormead in 1313⁹⁶; at Hitchin (1268), Langley and Shenley (1291).⁹⁷ At Sawbridgeworth between 1260 and 1270 its value was 2*s.* to 3*s.* an acre⁹⁸; in 1302-3 other meadows there in Pisho Manor were worth 2*s.* 6*d.* to 3*s.*⁹⁹ The lowest value mentioned is 18*d.* an acre at Sacombe¹⁰⁰ in 1282-3, and Wigginton in 1284.¹ Nor do these prices vary much in the first half of the 14th century. Meadow-land had a natural protection from its very restricted amount.

⁸³ Chan. Inq. p.m. 12 Edw. II, no. 43.

⁸⁴ Ibid. 17 Edw. II, no. 43.

⁸⁵ Ibid. 3 Edw. III (1st nos.), no. 53; 11 Edw. II, no. 20. ⁸⁶ Ibid. 3 Edw. III (1st nos.), no. 53.

⁸⁷ Ibid. Edw. III, file 64, no. 20.

⁸⁸ Ibid. 17 Edw. II, no. 39; 12 Edw. II, no. 43.

⁸⁹ Ibid. 16 Edw. II, no. 42.

⁹⁰ Lay Subs. R. Herts. bble. 120, no. 22; *Inq. Nonarum* (Rec. Com.), 431 et seq.

⁹¹ Ibid.

⁹² Ibid. ⁹³ Ibid. The original returns are now illegible in large part.

⁹⁴ Stowe MS. 849, fol. 50 et seq.

⁹⁵ Chan. Inq. p.m. 24 Edw. I, no. 107.

⁹⁶ Ibid. 7 Edw. II, no. 26.

⁹⁷ Ibid. 53 Hen. III, no. 43; Rentals and Surv. R. 279.

⁹⁸ Chan. Inq. p.m. Hen. III, file 29, no. 2, 9; 56 Hen. III, no. 37.

⁹⁹ Rentals and Surv. portf. 8, no. 43.

¹⁰⁰ Chan. Inq. p.m. 11 Edw. I, no. 49.

¹ Ibid. Edw. I, file 38, no. 8.

A HISTORY OF HERTFORDSHIRE

Of pasture-land also there was no excess. Its value seems to have averaged about 1*s.* an acre, but at Sawbridgeworth in 1271² and at Wyddial in 1284 it was as low as 6*d.*³ At Shenley in 1276 50 acres of several pasture were worth only 3*d.* an acre.⁴ By 1291 the extent was reduced to 18 acres, and the value had risen to 4*d.* an acre.⁵

The commutation of week work created, or at least increased, the demand for ordinary farm labour; the farm-houses began to be occupied by a permanent staff of labourers, sufficient for the everyday work of the farm.

At Langley in 1296–7 a carter, four ploughmen, a shepherd and two farm servants, one of whom acted as cook, were kept. Ten years later we find also a parker and two gardeners worked there for part of the year.⁶ At Temple Dinsley in 1312 there were a resident bailiff, a carter, four ploughmen and four other labourers, besides a cook-gardener.⁷

Ploughing apparently remained steady in value throughout the county during the period from 1260 to 1347. The price was 6*d.* an acre at Langley in 1291,⁸ Watton in 1324,⁹ and Standon in 1347.¹⁰ Harrowing likewise remained at the same value throughout the period. One day's work was worth 1*d.*¹¹ The villeins, however, often performed this service, instead of paying for it. The general field and farm work of the villeins grouped as week work shows no deviation in price from the customary standard of $\frac{1}{2}$ *d.* a day.¹² Compared with the wage of the agricultural labourer, this was beneath the ordinary wage. Commutation was, however, often an economy to the lord, because he received $\frac{1}{2}$ *d.* from perhaps half a dozen villeins, and in their place probably only needed to pay his hired labourer 2*d.* for one day's work.

Hedgers and thatchers had 2*d.* a day.¹³ Ploughmen and carters were usually paid by the year, the value of board and lodging being considered in the amount of the wages. A portion also was often paid in corn at the harvest.

The cowherd, more often called the 'Daye,' or dairyman, received high wages. He had 22*d.* in winter and corn in the fields in the autumn at Hormead in 1261.¹⁴ This method of payment gave way before 1338, when he took 5*s.* a year.¹⁵ These high wages were given at Standon in 1347¹⁶; 3*s.* a year seems to have been more usual.¹⁷ Shepherds' wages were equal to those of the cowherd.¹⁸

In the case of harvest work the contrast between the sum paid by the villeins in redemption of their works and the labourer's wage becomes sharper, because we have more and more detailed evidence. The usual value of a

² Chan. Inq. p.m. 56 Hen. III, no. 37.

³ Ibid. Edw. I, file 38, no. 4.

⁴ Rentals and Surv. R. 296.

⁵ Ibid. R. 279.

⁶ Mins. Accts. bdle. 866, no. 17.

⁷ Ibid. bdle. 865, no. 13. This list is incomplete, as some of the wages are erased.

⁸ Rentals and Surv. R. 279; Mins. Accts. bdle. 866, no. 17, 21.

⁹ Chan. Inq. p.m. 17 Edw. II, no. 39.

¹⁰ Mins. Accts. bdle. 869, no. 8.

¹¹ Ibid. bdles. 40, no. 740; 866, no. 17, 19; 869, no. 8; Chan. Inq. p.m. 20 Edw. III, no. 23.

¹² Chan. Inq. p.m. Edw. I, file 38, no. 4; Mins. Accts. bdle. 870, no. 20; Chan. Inq. p.m. Edw. II, file 47, no. 12; 16 Edw. II, no. 42; 17 Edw. II, no. 39; Mins. Accts. bdle. 867, no. 4; Ct. R. (Gen. Ser.), portf. 177, no. 33; Chan. Inq. p.m. 20 Edw. II, no. 23; Stowe MS. 849, fol. 50 et seq.; Chan. Inq. p.m. Edw. III, file 64, no. 20.

¹³ Mins. Accts. bdle. 866, no. 17, 21.

¹⁴ Ibid. no. 1.

¹⁵ Ibid. no. 5.

¹⁶ Ibid. bdle. 869, no. 8.

¹⁷ Ibid. bdles. 867, no. 4; 862, no. 6; Add. Chart. 28737.

¹⁸ Add. Chart. 28737; Mins. Accts. bdles. 869, no. 8; 40, no. 74; 866, no. 21, 29.

SOCIAL AND ECONOMIC HISTORY

day's work in harvest varied from 1*d.* to 2*d.* At Wyddial in 1284,¹⁹ and at Shenley in 1291,²⁰ the amount was 1½*d.* At Langley from 1307 it was 2*d.* (and 1*d.* for a smaller work).²¹ A penny was evidently considered the customary amount by the men of Standon in 1324.²²

The hay harvest brought with it the works of reaping, tossing, binding and stacking. Reaping was highly paid, and the customaries' day's work was usually valued at 2*d.* This was the valuation at Langley from 1297 to 1317.²³ In 1324 the villeins did most of the work; but the 2½ acres reaped by hired labour cost 6*d.* an acre.²⁴ At Meesden in 1316 the hired reapers were paid 5*d.* an acre²⁵; if, as is sometimes estimated, half an acre was a day's work,²⁶ this would be a good wage. In 1325-6 the reaping at Symondshyde in Bishop's Hatfield was done by hired labourers at 6*d.* an acre and the lifting and other helping by the villeins.²⁷ About twenty years later the reapers at Standon took 5*d.* an acre, while the mowing of the customaries was only valued at 2*d.* a work.

At Hormead the wage paid in 1262 was a loaf and 4*d.* an acre for corn, a loaf and 5*d.* for wheat, a loaf and 3*d.* for oats.²⁸ The 4*d.*, 5*d.*, and 6*d.* rates seem to have been usual. Thus the discrepancy between the rates of hired labour at different times and places is not as great as that between hired and customary labour. The numerous and early cases in which reaping was given out *ad tascham* suggest the economy of the dearer form of labour.

Threshing was the other important harvest work. It was usually paid by the quarter and sometimes by the nine bushels. Wheat and peas were charged 2*d.* a quarter at Langley in 1307-8,²⁹ at Stevenage in the next year 2½*d.* for the nine bushels.³⁰ 2½*d.* a quarter was the rate at Dinsley in 1312³¹; a few years later it had risen. At Langley it was 4*d.* for wheat and 3*d.* for peas in 1316-17,³² and at Meesden wheat cost 3*d.*³³ Possibly this was a temporary effect of the bad year 1315; for in 1326 wheat, peas and beans had fallen to the old rate of 2*d.* at Symondshyde,³⁴ and twenty years later, at Ashwell, the nine bushels were threshed for 2½*d.*,³⁵ and the quarters of wheat and peas for 2*d.* at Standon and Pré.³⁶ The rise in the wheat price was naturally accompanied by a rise in barley. The usual rate was 1½*d.*,³⁷ which increased in 1316-17 to 2¼*d.*³⁸ The 1½*d.* rate must have set in again about the same time as the reduction in corn.³⁹

Drage was threshed at 1¼*d.* a quarter and oats at ¾*d.* at Langley in 1307-8.⁴⁰ At Stevenage the prices were 1½*d.* and 1*d.* the nine bushels.⁴¹ About 1312-13 the prices seem to have risen.

At Dinsley oats were at 1*d.*⁴² and drage rose at Langley to 1½*d.* and oats to 1*d.*⁴³ In 1316 oats were 1¼*d.* at Meesden.⁴⁴

¹⁹ Chan. Inq. p.m. Edw. I, file 38, no. 4.

²¹ Mins. Accts. bdle. 866, no. 17, 19, 21, 29.

²³ Mins. Accts. bdles. 40, no. 740; 866, no. 17, 21.

²⁵ Ibid. bdle. 867, no. 4.

²⁷ Add. Chart. 28737.

³⁰ Ibid. bdle. 870, no. 20.

³³ Ibid. bdle. 867, no. 4.

³⁵ Mins. Accts. bdle. 862, no. 6.

³⁷ Ibid. bdle. 866, no. 17.

³⁹ Ibid. bdles. 866, no. 5; 862, no. 6; 869, no. 8.

⁴¹ Ibid. bdle. 870, no. 20.

⁴⁴ Ibid. bdle. 867, no. 4.

²⁰ Rentals and Surv. R. 279.

²² Ct. R. (Gen. Ser.), portf. 178, no. 38.

²⁴ Ibid. bdle. 866, no. 29.

²⁶ Ct. R. (Gen. Ser.), portf. 177, no. 33.

²⁸ Mins. Accts. bdle. 866, no. 1.

²⁹ Ibid. no. 17.

³¹ Ibid. bdle. 865, no. 13.

³² Ibid. bdle. 866, no. 21.

³⁴ Add. Chart. 28737.

³⁶ Ibid. bdles. 869, no. 8; 867, no. 22.

³⁸ Ibid. no. 21.

⁴⁰ Ibid. bdle. 866, no. 17.

⁴² Ibid. bdle. 865, no. 13.

⁴³ Ibid. bdle. 866, no. 19.

A HISTORY OF HERTFORDSHIRE

Peas and drage were threshed together at $1\frac{1}{4}d.$ a quarter in Bishop's Hatfield in 1326,⁴⁵ and the higher rate seems to have held for a long time, for in 1338-9 drage was still $1\frac{1}{4}d.$ and oats $1d.$ at Little Hormead,⁴⁶ and at Ashwell.⁴⁷ A little later at Standon drage cost $1\frac{1}{2}d.,$ ⁴⁸ and at Pré drage and oats were charged $1\frac{1}{4}d.$ ⁴⁹ Thus a slight increase on the wage at the beginning of the century prevailed by about 1340.

Hoeing was often done by the villeins in person, and its value was low. At Gaddesden in 1284 the customary day's work was only worth $\frac{3}{4}d.$ ⁵⁰; at Langley Church it was let out in 1277 at about $\frac{1}{2}d.$ an acre,⁵¹ which is comparable with the villein's hoeing valued at $\frac{1}{2}d.$ at Standon in 1347⁵² and at Ashwell in 1340.⁵³

The labourers must usually have been inhabitants of the villages where they worked or of the immediate neighbourhood. The local supply of labour was probably about equal to the demand. In 1324 the men of Standon made a by-law that 'no one who can reap or work to the value of $1d.$ a day shall give lodging to any stranger or suspect, to harvest the lord's grain in the fields,'⁵⁴ which implies that labour was beginning to circulate sluggishly, and that the circulation was resented by those who stayed at home.

The history of agricultural prices differs a little from that of wages, and this difference is one of the greatest importance.

As Hertford was and is a tillage county, in virtue of its soil, grain was its most important product. We have seen that as early as 1247 its corn was exported to London.⁵⁵ In the period from 1297 to 1314, after allowance for the difference of price at the different seasons, the average seems to be about $8s.$ or $7s. 4d.,$ $6s. 8d.$ or $6s.$ at the dear times of the year, and $4s.,$ or once in 1313, $3s. 4d.$ a quarter after harvest.⁵⁶

But in 1315 there was a disastrous change. 'In the summer,' probably just before the harvest, when grain stood highest, corn was selling at Meesden for $20s.$ ⁵⁷ the quarter, and at Langley for $16s.,$ $17s. 4d.$ and $20s.$ ⁵⁸ These prices must have been prohibitive to the small farmer and labourer. The population must have lived upon barley or mixtil or oats. At these prices even the lord must have been hard put to it for seed corn.

By 1324-5 prices at Langley had come down to the average variation between $8s. 8d.$ and $4s. 8d.$ ⁵⁹ At Hormead in 1323 the summer corn was cheap, $5s. 4d.$ the quarter,⁶⁰ and this is paralleled at Symondshyde in 1326, when wheat was $4s. 6d.$ in July, falling later to $3s. 4d.$ ⁶¹ From this time the $8s.$ to $4s.$ cycle of prices seems about the average, with a tendency to the lower level.⁶² Oats were less affected than wheat by the bad years. Their prices had ranged between $3s. 4d.$ and $2s. 8d.$ a quarter,⁶³ and in 1316 their highest recorded price was $5s. 6d.$ ⁶⁴; after this the amounts sink down

⁴⁵ Add. Chart. 28737.

⁴⁶ Mins. Accts. bdle. 866, no. 5.

⁴⁷ Ibid. bdle. 862, no. 6.

⁴⁸ Ibid. bdle. 869, no. 8.

⁴⁹ Ibid. bdle. 867, no. 22.

⁵⁰ Chan. Inq. p.m. Edw. I, file 38, no. 8.

⁵¹ Mins. Accts. bdle. 866, no. 7.

⁵² Ibid. bdle. 869, no. 8.

⁵³ Ibid. bdle. 862, no. 6.

⁵⁴ Ct. R. (Gen. Ser.), portf. 178, no. 38.

⁵⁵ See above.

⁵⁶ Mins. Accts. bdles. 40, no. 740; 870, no. 20; 865, no. 13; 866, no. 19.

⁵⁷ Ibid. bdle. 867, no. 4.

⁵⁸ Ibid. bdle. 866, no. 21.

⁵⁹ Ibid. no. 29.

⁶⁰ Ibid. no. 3.

⁶¹ Add. Chart. 28737.

⁶² Mins. Accts. bdles. 866, no. 5; 869, no. 8; 867, no. 22.

⁶³ Ibid. bdles. 40, no. 470; 866, no. 1, 17; 870, no. 20.

⁶⁴ Ibid. bdle. 867, no. 4.

SOCIAL AND ECONOMIC HISTORY

apparently slightly below the former level.⁶⁵ At Little Hornead in 1338-9 the quarter cost 1*s.* 2*d.* only,⁶⁶ and at Ashwell was only 1*s.* 10*d.* as late in the agricultural year as February.⁶⁷

Peas and drage seem to follow the same lines of price. In 1297 peas stood at 5*s.* a quarter at Langley.⁶⁸ Presumably they rose higher towards 1315-16; in 1324-5, in autumn, they were worth 6*s.* a quarter.⁶⁹ Within the next few years their price seems to have fallen, like that of other cereals, over a long period. In 1338-9 the quarter at Little Hornead was only 2*s.*⁷⁰; at Standon in 1347-8 the price was 3*s.* in June, falling to 2*s.* 8*d.*, and after harvest time to 2*s.* 4*d.*⁷¹ Similarly in the neighbourhood of St. Albans in 1342-3 the Lent price was 3*s.* and the November price 2*s.* 10*d.*⁷²

Drage was about equal to peas in value. In 1297 the quarter cost 4*s.*⁷³ At the same place, Langley, the price was doubled in 1316-17.⁷⁴ After this time it shows a steady fall. It was down to 5*s.* 4*d.* at Langley in 1324-5,⁷⁵ and at Symondshyde in 1326 only 3*s.* to 3*s.* 2*d.*⁷⁶ From 1339 to 1349 the prices mentioned are 2*s.* 4*d.*, 2*s.* 8*d.* and 4*s.*⁷⁷

The prices of barley and of malt naturally keep close together. Barley was about 4*s.* the quarter before 1315 and malt 4*s.* 6*d.*⁷⁸ In 1316-17 malt rose to 10*s.* 3*d.*,⁷⁹ and barley presumably with it. By 1323 at Little Hornead barley had fallen to 3*s.* 4*d.*,⁸⁰ and at Symondshyde in 1326 seed barley was 4*s.*⁸¹; at Standon in 1347-8 the price in June was 5*s.* 4*d.* a quarter,⁸² and malt was 5*s.* at the beginning of summer, falling in August and September to 4*s.* 6*d.* a quarter.⁸³ The prices of barley and malt, perhaps, did not share the general fall after about 1320; they seem only to have dropped to their former level.

It is important to notice that the rise of prices which occurred about 1316 was not followed by a corresponding increase of wages, the reason being probably that the rise was sudden and temporary. There was, however, a tendency towards higher wages about 1340, although prices were low. The class of labourers was growing, but the small freeholder and the villein alike were willing to take up the land which the lord was pleased to part with. In this period rents are more significant than wages.

The cattle trade did not hold a very great place in Hertfordshire. On some few manors there were dairies, or the cows were let out at farm, but usually the cows only supplied the domestic need and sometimes not even that. Where murrain was endemic cattle farming cannot have been an engaging pursuit. The price of cows varied in 1250 to 1340 from 5*s.* to 10*s.*, while that of oxen went up to 16*s.*⁸⁴

From the 13th century large flocks of sheep were kept in the county.⁸⁵⁻⁶ Endemic murrain seems to have become violent in 1274, and to have lasted

⁶⁵ Mins. Accts. bdle. 869, no. 8; Add. Chart. 28737.

⁶⁶ Mins. Accts. bdle. 866, no. 5.

⁶⁷ Ibid. bdle. 862, no. 6.

⁶⁸ Ibid. bdle. 40, no. 740.

⁶⁹ Ibid. bdle. 866, no. 29.

⁷⁰ Ibid. no. 5.

⁷¹ Ibid. bdle. 869, no. 8.

⁷² Ibid. bdle. 867, no. 22.

⁷³ Ibid. bdle. 40, no. 740.

⁷⁴ Ibid. bdle. 866, no. 21.

⁷⁵ Ibid. no. 29.

⁷⁶ Add. Chart. 28737.

⁷⁷ Mins. Accts. bdles. 866, no. 5; 869, no. 8; 867, no. 22.

⁷⁸ Ibid. bdle. 866, no. 19.

⁷⁹ Ibid. no. 21.

⁸⁰ Ibid. no. 3.

⁸¹ Add. Chart. 28737.

⁸² Mins. Accts. bdle. 869, no. 8.

⁸³ Ibid.

⁸⁴ Ibid. bdle. 866, no. 1; Exch. Proc. bdle. 144, no. 133; Stowe MS. 849, fol. 50 et seq.; Mins. Accts. bdle. 866, no. 17.

⁸⁵⁻⁶ e.g. at Caddington 60, Hitchin 128; Exch. Proc. bdle. 144, no. 133, co. Herts.

A HISTORY OF HERTFORDSHIRE

twenty-eight years, according to the St. Albans chronicler⁸⁷; his statement may have been accurate locally. The price of wool by the fleece may have averaged about $8\frac{1}{2}d.$ This was the rate at Stevenage in 1308⁸⁸ and at Standon in 1347.⁸⁹ In gross the price was lower. Fourteen and a half fleeces were sold for 8s. at Stevenage,⁹⁰ and at Pré in 1342–3 six were sold for 2s. 2d., at the weight of eighty-seven to 15 stone.⁹¹ Possibly these were poor skins. At Langley in the bad year 1316 sixty-eight fetched 6d. each.⁹²

This wool was worked up for the most part in the villages, where the lord's fulling-mill finished the homespun, and in the 13th century the burgesses of St. Albans—Henry de la Porte and his companions—seem to have been clothmakers rather than wool dealers. Their market was presumably among the townsfolk and the richer people of the shire. They may well have gone the round of the manor-houses at shearing time, combining the functions of the dealer and manufacturer. From such a condition the St. Albans man could easily decrease his handwork and devote himself to wool dealing, as the London buyers were willing to take more. The markets along the great road would naturally be the meeting-place of the Londoner and the local man. In 1286, at Royston Market, one Robert Jukes was selling ninety fleeces to a merchant, when Walter Ulgate came up and told the merchant that it was marsh-grown wool and not worth his buying, so that the sale was broken off, to Robert's loss of 30s.⁹³ Early in the 14th century this increase seems to have begun. In a list of the time of Edward III, dealing with the trades of Watford, two 'sellers of cloth'⁹⁴ are mentioned and six wool merchants.⁹⁵ In 1326 William Persone of Watford and J. Baret of Baldock were shipping wool from Sandwich to Antwerp for Brabant.⁹⁶ These merchants dealt directly with the landholders; but probably many of the latter bought up supplies from the small freeholders and villeins and dabbled in the trade.

In 1341 at Hemel Hempstead fifty-one persons, including many women, had a stock of 17 stone 3 lb.⁹⁷ At Berkhamstead there was the same amount. At Bushey thirty-eight capitalists, of whom the Countess of Kent was one of the biggest, had nearly 20 stone. At Great Gaddesden the two men who held $13\frac{1}{2}$ lb. were probably lords of manors. The eleven men and women mentioned at St. Albans were apparently dealers rather than producers. The total for St. Albans is 15 stone, and at Childerwick $7\frac{1}{2}$ stone.⁹⁸

The monk of St. Albans writes in 1349: 'A pestilence came which almost halved all flesh.' The prior and sub-prior died with forty-seven monks, besides those who died in the cells of the abbey.⁹⁹ Another St. Albans chronicler writes less accurately that hardly one-tenth of the people was left alive; more than forty monks died.¹⁰⁰

The Plague reached London by the beginning of November 1348, Norwich by the New Year.¹ The first cases in Herts. may well have

⁸⁷ Walsingham, *Hist. Angl.* (Rolls Ser.), i, 14.

⁸⁹ *Ibid.* bdl. 869, no. 8.

⁹² *Ibid.* bdl. 866, no. 21.

⁹⁴ Distinguished from the ten tailors.

⁹⁶ *Cal. Close*, 1323–7, p. 594.

⁹⁹ Walsingham, *Gest. Abbat.* (Rolls Ser.), ii, 369.

¹ W. J. Ashley, *Econ. Hist.* pt. ii.

⁸⁸ Mins. Accts. bdl. 870, no. 20.

⁹⁰ *Ibid.* bdl. 870, no. 20.

⁹¹ *Ibid.* bdl. 867, no. 22.

⁹³ Ct. R. (Gen. Ser.), bdl. 62, no. 765, m. 5.

⁹⁵ Lay Subs. R. Herts. bdl. 242, no. 17.

⁹⁷ Lay Subs. R. Herts. bdl. 242, no. 68.

⁹⁸ *Ibid.*

¹⁰⁰ *Chron. Angl.* (Rolls Ser.), 27.

SOCIAL AND ECONOMIC HISTORY

occurred in the autumn, especially in the districts on the Great North Road. At Codicote early in November 1348 there is a suspicious mortality of five tenants.² The outburst was not at its worst until the spring. In May 1349 at Tyttenhanger thirty-one tenants died,³ at Codicote fifty-nine before 19 May and later twenty-five more.⁴ At Stevenage the worst was after February 1349,⁵ and at Standon, where the disease remained from March until Midsummer, the highest number of deaths, sixteen, occurred in April.⁶

The evidence is clearer as to the dates of the Plague than as to the death-rate. In our ignorance of the population before the outbreak we cannot estimate the numerical or proportionate loss. The study of its effects in particular cases is safer and more impressive.

The Black Death has usually been made a cause of labour trouble, as distinct from trouble among villeins and freeholders, but precise examples and the delimitation of the share of the landless and the landholder in the revolt are somewhat less common. In Hertfordshire there is material for an attempt.

Clearly customary labour would continue at the old price, and this the manorial rolls attest.

The change was great in wages of hired harvest labour. At Pré in 1350 the threshing of wheat cost 4*d.* a quarter, beans 3*d.* and drage 2½*d.*⁷ Eight years before prices for wheat and drage had been 2*d.* and 1¼*d.* respectively.⁸ The reapers in 1350 had some 4*d.*, some 2*d.* a day; they had formerly been paid 3*d.* to 5*d.* an acre. A man mowing received 5*s.* a month, presumably 2*d.* a day and his board.⁹

The figures from Ashwell show a similar rise. In 1352 an acre of wheat was reaped for 10*d.* and food, an acre of peas for 6*d.*¹⁰ Threshing cost 3*d.* a quarter for wheat and peas, 2½*d.* for drage. The corresponding wages for 1340-1 were 6½*d.* and 4*d.* for reaping, for threshing 2¼*d.* and 1½*d.*¹¹

At Meesden in 1355 reapers were paid 8*d.* an acre; wheat was threshed at 3*d.* a quarter, peas at 2*d.*, oats at 1½*d.*¹² In 1346-7 reaping of peas cost 5*d.* the acre, oats 4*d.*, the threshing prices were 2*d.*, 1½*d.* and 1*d.*¹³

These figures are above the statutory rate of 1351. Under the Act reapers received 5*d.* an acre, or 5*d.* a day, hoers or haymakers 1*d.*, threshers of wheat 2½*d.* a quarter, and of other crops 1½*d.* Customary works remained at the customary sum.¹⁴ At Ashwell in 1352 and Pré in 1350 the day's work in harvest was still sold to the villeins at 1*d.* and a hoeing work at ½*d.*¹⁵ These may stand as typical of many other manors. At Meesden the bailiff adopted the alternative plan. In 1355-6 the hoeing and part of the reaping were actually done by the villeins, and 263 men still came to seven boondays.¹⁶ But the lord who sold these works at 1*d.* each evidently made a loss.

The rise in agricultural wages in the rest of the year is hard to estimate. The ordinary workman seems to have had about 2*d.* or 3*d.* a day, rising later to an average of 4*d.* a day.¹⁷

² Stowe MS. 849, fol. 50 et seq.

³ Caledon D. Ct. R. Tyttenhanger.

⁴ Stowe MS. 849, fol. 50 et seq.

⁵ Ct. R. (Gen. Ser.), portf. 178, no. 48.

⁶ Ibid. no. 41.

⁷ Mins. Accts. bdle. 867, no. 23.

⁸ Ibid. no. 22.

⁹ Ibid. bdle. 867, no. 23.

¹⁰ Ibid. bdle. 862, no. 6.

¹¹ Ibid.

¹² Ibid. bdle. 867, no. 8.

¹³ Ibid. no. 6.

¹⁴ Par. R. ii, 233-4.

¹⁵ Mins. Accts. bdles. 867, no. 23; 862, no. 6.

¹⁶ Ibid. bdle. 869, no. 8.

¹⁷ At Hatfield, Essendon and Hertford (Mins. Accts. bdles. 58, no. 1079; 873, no. 25).

A HISTORY OF HERTFORDSHIRE

The cowherd's yearly wage, which had been about 4*s.*,¹⁸ seems to have risen 1*s.* At Pré in 1350 and at Ashwell in 1352 5*s.* is the sum.¹⁹ But this had been given at Little Hormead in 1338.

The average shepherd's pay, 3*s.* a year, tended upwards, sometimes to 5*s.* The carter's daily wage rose of necessity after the cattle plague. Instead of 8*d.* a day,²⁰ the usual rate by 1381 was 1*s.* 4*d.* to 2*s.* a day.²¹ The ploughman's wage was most frequently still paid in corn, but 8*s.* at Pré was paid for the year, or 3*s.* for the winter half-year and 5*s.* for the summer.²² This may also, perhaps, imply a rise of 1*s.*

The wages of the craftsman would be expected to rise as much as those of the labourer. The crafts were so simple and so necessary that the demand was not very elastic, and the decrease of population would only decrease the demands on the crafts proportionately.

But the rise was apparently less marked in the trades than in farm work. A tiler took 3*d.* a day,²³ a tiler and his boy 5*d.* a day at Meesden, against 3½*d.* in 1346-7, but 3*d.* had been a not uncommon rate in other parts of the country. In another case the pay is much higher, the man and his helper having 8*d.* and another pair 10*d.*²⁴ Carpenters were still working in 1350 for 2*d.* or 3*d.* a day,²⁵ approximately the rates allowed by the Statute of Labourers. But many must have asked more. About thirty years later the almost invariable rate was 4*d.* or 5*d.*²⁶ A master carpenter had 6*d.* a day at Hertford in 1381.²⁷ In 1351 the Commons granted three-tenths and three-fifteenths on condition that all fines of the Statute of Labourers should be in aid of it.²⁸ The fines paid in the half-hundred of Hitchin show that in 1351 the statute was being enforced in the little places, where the offenders must have been mostly agricultural labourers. At Meppershall the fines came to 2*s.*, at Stagenhoe to 4*s.*, at Lilley to 17*s.* and at Ickleford to 10*s.* 3*d.* In the larger places many fines must have come from artificers. Kimpton paid 19*s.*, King's Walden 25*s.* 1*d.*, Offley 25*s.*, Dinsley 33*s.* 1*d.*, Pirton 36*s.* 9*d.* and Hitchin with its foreign £4 4*s.* 4*d.* The total is £13 7*s.* 6*d.* The towns are so pre-eminent that the artificers must have been pretty general contributors.

Berkhampstead paid 50*s.*, Rickmansworth 30*s.*, Cheshunt 53*s.* 4*d.*, Baldock £4 6*s.* 6*d.*, Ware £5 and St. Albans £10. The total for the county is £122 6*s.* 3*d.*²⁹

This is enough to show that the labourers were a rising class with a rising wage and one which was fighting the statute law. The manorial courts had threatened them too, in so far as they included the fugitive villeins.³⁰ This was an old trouble; we cannot tell how far the Plague actually increased it, but the increase of presentments of fugitive villeins at the manorial courts after 1349 is very significant. The stewards registered the presentments on the rolls, and the same order for the return of the same men occurs year after year for ten or twelve years; such an order was all the power the lord had. In fact, villeins had for long been allowed to live away if they paid a small

¹⁸ See above.

²⁰ See above.

²² *Ibid.* bdle. 867, no. 23.

²⁵ *Ibid.* bdle. 867, no. 23.

²⁷ *Ibid.* bdle. 58, no. 1079.

²⁹ *Lay Subs. R. Herts.* bdle. 120, no. 29.

¹⁹ *Mins. Accts. bdles.* 867, no. 23; 862, no. 6.

²¹ *Mins. Accts. bdles.* 58, no. 1078; 873, no. 25.

²³ *Ibid.*

²⁶ *Ibid.* bdles. 58, no. 1079; 873, no. 25.

²⁵ *Parl. R.* ii, 238.

²⁴ *Ibid.* bdle. 873, no. 25.

³⁰ See above.

SOCIAL AND ECONOMIC HISTORY

chevage. The chevage rather than restraint of the person was the lord's aim. At a court in 1351 the Codicote jury presented four villein fugitives, who were in London, Baldock, Weston and Knebworth.³¹ Two years later three of these were still away, and four other fugitives were presented. The order to take them was repeated as late as 1357. In Michaelmas of that year three villeins undertook that the son of one of the fugitives should remain within the manor.³² One escaped villein might well draw away his proper successor and leave the tenement empty. In some cases the wife of the fugitive was allowed to take up the lands, obviously a poor substitute.

In 1362 five other men and one woman were presented, one of them being the son of a fugitive previously referred to. Again, in 1373 nine fugitives were presented, two of them being women and two apparently of the same family, showing how one member of a family followed another, or a couple went together. The kinds of employment, domestic service or the crafts, are indicated.

At Benington in 1362 a villein and half-virgater made fine 'that he may dwell where he likes as a trader (*ad mercandizandum*)' doing the services due from his tenements and paying four capons as chevage for respite of suit of court except at the view.³³

At Tyttenhanger in 1369 one villein was living 'at the manor of Mimms,' another had crossed the sea, and two others dwelt in Kent. The two latter had not come back four years later.³⁴ But the rolls of Stevenage and Standon about this time are clear of similar entries. Being to some extent industrial, they probably attracted fugitives.

The immediate effect in 1350 was the emptiness of the land and the poverty of the survivors. At Martinmas 1350 at Codicote fifteen tenements were still in the lord's hand.³⁵ Sixteen tenements were neither given nor leased at Ashwell in 1352.³⁶ The lord of Stevenage granted a virgater who had been paying 22s. for all service to pay 13s. 4d. for three years from 1353. The lords were poor too; unoccupied houses were allowed to decay or were pulled down, dovecots fell down, underwood was cut and not replaced. As late as 1375 three water-mills were ruinous.³⁷ They were unrepaired two years later.³⁸ So too was the water-mill of Ayot St. Lawrence.³⁹ The manorial courts were busy admitting heirs and providing minors with guardians.⁴⁰ In one case the whole homage was made the guardian, as they say 'that none of them alone is sufficient.'⁴¹ The courts were busy too at old work, reporting and fining those who did not come to do their labour services. In the Plague summer August 1349, at Standon, thirty-two men of the commonalty of the vill of Bury failed to come to mow the lord's hay, which was destroyed by their neglect.⁴² The bailiff of Codicote sent certain tenants to St. Albans to show by what services they held certain lands. But other tenants of the same manor subtracted thirty works a year in the three years following the Plague.⁴³ Six of the villeins of Tyttenhanger stayed away from the boondays and were fined for it in 1357. In 1366 P. Beedel

³¹ Stowe MS. 849, fol. 50 et seq.

³² Ibid.

³³ Ct. R. (Gen. Ser.), portf. 177, no. 8.

³⁴ Caledon D. Ct. R. Tyttenhanger.

³⁵ Stowe MS. 849, fol. 50 et seq.

³⁶ Mins. Accts. bdle. 862, no. 6.

³⁷ Chan. Inq. p.m. 49 Edw. III, pt. i, no. 74, m. 4.

³⁸ Ibid. I Ric. II, no. 30.

³⁹ Ibid. pt. ii, no. 28.

⁴⁰ Caledon D. Ct. R. Tyttenhanger.

⁴¹ Ct. R. (Gen. Ser.), portf. 178, no. 48.

⁴² Ibid. no. 41.

⁴³ Stowe MS. 849.

A HISTORY OF HERTFORDSHIRE

withdrew thirty men from one booday, Richard atte Chapel six men, J. Pope seven, J. Cropin six, R. Shepherd three and J. Derham sixteen.⁴⁴ It was, no doubt, better to take money from the villeins beforehand and hire labour than to run the risk of being thirty or forty men short, and possibly recovering no fine from the tenant afterwards. The labour problem would of course take different form in different villages. Where commutation had become a custom it could hardly be reconverted, but where it was a matter of convenience both the lord and the villein probably preferred a labour rent to cash for a year or two after the Plague. Thus at Meesden in 1346 the customaries bought 324 winter week works at $\frac{1}{2}d.$ each. In 1355 the 591 works due (two tenements were empty) were seemingly all performed.⁴⁵ Of 325 autumn week works only twenty-five were sold, but at the earlier date the villeins seem to have done the autumn week works and the boon works, though the reapers were hired. At some places the recovery was quicker. At Ashwell in 1352 the autumn boondays were redeemed, just as they had been in 1340, and three works of hoeing and stacking were sold.⁴⁶ At Pré in 1351 all the autumn labour was hired. There was clearly no violent reversal. Such immediate adaptation to circumstances would have required enlightened self-interest and independence of custom quite foreign to mediaeval habits of mind.

If the lords had wanted labour service they might have stipulated for it in grants. Hired labour, we know, was an expense of the economical kind, and further, the lords wanted money in a time of a rising standard of comfort, and the tenants, after a year or so, were more willing to give money than labour.

The grants made in a few manors show in how small a number labour services were involved; a large amount of the old villein land, now empty, was passing into the class of land held at a rent, villein only in name and in certain legal consequences. Economically this class of unfree land was equal to freehold. Of three grants in villeinage made by the lord in the court of Codicote in November 1350 two were for rent (in one case of $4d.$ an acre) and suit of court, the others for the autumn booday and suit of court. These show, incidentally, how cheaply land was selling. Other examples are of one grant for rent only and one more grant at a rent of $4d.$ an acre. On the other side are three grants in villeinage for the customary services.⁴⁷

At Tyttenhanger, also a manor of St. Albans, the commonest grant seems to be for rent and the due customs. Possibly St. Albans villis may have been distinguished by this form of grant from those of other lords. If so, their share in the Peasants' Revolt is to a great extent explained. At Munden Furnival in 1351 the lord granted villein tenements for rent for 'all service except common scot,' or for rent only. In one instance the villein heir claimed and received his inheritance, doing the due and accustomed service. He then surrendered it, and the lord regranted it to another man for $24s.$ a year for all service, clearly preferring money to labour. When the lord gave terms of life also, he accepted rent for all service.⁴⁸ At Standon in 1352 in five instances villein tenements were granted at will for rent only. So, too,

⁴⁴ Caledon D. Ct. R. Tyttenhanger under date.

⁴⁵ Mins. Accts. bdl. 867, no. 6, 8.

⁴⁷ Stowe MS. 849, fol. 50 et seq.

⁴⁶ Ct. R. (Gen. Ser.), portf. 176, no. 134.

⁴⁸ Ct. R. (Gen. Ser.), portf. 178, no. 7.

SOCIAL AND ECONOMIC HISTORY

in nine cases of tenements held at will for life.⁴⁹ About twenty years later, in the court of Stevenage, a villein took of the lord for life a messuage and virgate, paying 9s. rent. The same rent had been paid by another life tenant since 1314.⁵⁰ The size of the tenement suggests that it was a typical villein holding, possibly empty since 1349. In these cases the emphasis put on money is stronger than in Codicote or Tyttenhanger.

It must be realized how large a proportion of villein land was beginning to be held on lease, to which the lords of Codicote and Tyttenhanger tacked on little labour services. Of five leases given at one court two were for rent only, two for rent, common suit and heriot, one for rent, common suit and the autumn boonday.⁵¹ There are many other examples of both kinds in the Court Roll of Codicote. In 1351 the lord granted to Stephen May all the lands late of Robert atte Strete, all the lands of Reginald Alleyn, Edward atte Hacche and J. atte Strete for eight and a half years for 20s. a year. 'And Stephen shall do all the service and customs belonging to the said lands, and he may remove one house.'⁵² Here one sees, incidentally, how the lease was convenient to the lord, as it could deal with any fraction or addition of holdings in clear terms. Most commonly it is small portions of land, the débris of the villein holdings, that are thus conveyed.

Five leases for nine years made in 1361 bear rent, suit of court and the autumn boonday.⁵³ At Standon and Munden the lease for rent only is most frequent; so also at Ashwell in 1351.

The effect on villein status is obvious, especially as the leases, short at first, were granted for long periods. Here was another means by which the differences between villein and free were obliterated. In practical life the economic difference between the cultivator of freehold and the cultivator of an arrented copyhold was negligible. The change from the lord's point of view is equally clear. The estate was becoming a more commercial, more manageable affair, as regarded unfree tenants. The lease brought in what was wanted—money—and gave the lord a command of the villein tenements at the end of short terms if he wanted them.

In the years between 1349 and 1380 the Hertfordshire villein had his opportunity. Land was cheap, and there was a considerable market for the produce; in fact, the villeins took land from the lords in large quantities. The yeoman class, economically, not legally differentiated, was in the making, and the villeins of higher standing were aiming at a rent-paying tenure. How conscious they were of its advantages they showed in the Peasants' Revolt.

As soon as freemen and villeins began to hold villein and free land indifferently (and this had begun long before 1350) villeinage was foredoomed. But the cheapening of land and the spread of leasehold made this condition a very general one.

The question for the lord was, should he throw the empty tenements into his demesne. This would perhaps have paid under an immediate extension of sheep farming, but he still thought tenants the most paying agricultural produce. In Hertfordshire the arable of the tenements was not converted into sheep pasture. Sheep farming was probably on the increase;

⁴⁹ Ct. R. (Gen. Ser.), portf. 178, no. 42.

⁵⁰ Ibid. no. 52.

⁵¹ Caledon D. Ct. R. Tyttenhanger.

⁵² Stowe MS. 849, under date given.

⁵³ Ibid.

A HISTORY OF HERTFORDSHIRE

but what it brought with it was an attempt on the part of the lord to overburden or inclose the common pasture. The demesne was not increased by the empty tenements either in arable meadow or pasture. At Walkern there was a difference of 7 acres between the extent of arable in 1313 and 1379,⁵⁴ and this may well be accounted for by lack of accuracy in surveying. The 340 acres of the arable in the great demesne of Hitchin was unchanged between 1290 and 1361.⁵⁵ The Court Rolls make it very clear that lords were not anxious to farm as capitalists.

Prices must have risen for a year or two after the Plague. At Pré in 1350 the quarter of wheat ranged from 6*s.* 8*d.* to 10*s.*⁵⁶ Later the average price was lower than the 4*s.* to 8*s.* range, but the change is slight. It is true that Lent corn was 12*s.* at Meesden in 1356,⁵⁷ but in other parts of the county the price in that year was only 5*s.* to 6*s.* At Ashwell a little earlier it was 6*s.* 8*d.*⁵⁸

Barley remained unchanged; 3*s.* 8*d.* and 3*s.* was the price of a quarter, against 3*s.* 4*d.* and 4*s.* in the earlier period. Drage appears to have been rather higher; 5*s.* and 6*s.* are quoted.

Oats, dear in 1350, seem to have dropped below the old level, which varied from 2*s.* 8*d.* to 3*s.* 4*d.* At Ashwell in 1352 the quarter was 4*s.* to 4*s.* 6*d.*⁵⁹ Four years later it was 2*s.* at Kelshall, Little Hadham and Bishop's Hatfield and 1*d.* dearer at Meesden.⁶⁰

Peas were 6*s.* 8*d.* at Ashwell in 1352,⁶¹ 6*s.* in August and 2*s.* in Lent at Meesden in 1356,⁶² 2*s.* 6*d.* at Kelshall and 4*s.* at Little Hadham.⁶³ The former price had been about 2*s.* 10*d.* to 3*s.*

Many rumours, carried perhaps by some wandering priest or prosperous clothmaker from London or the Kentish shore, must have reached Hertfordshire in the early part of June 1381. On Corpus Christi Day, Thursday, 13 June, the insurgent villeins of Kent and Essex, being encamped on Blackheath, marched down into London under John Ball, Jack Straw and Wat Tyler.⁶⁴ They fired the Savoy and surrounded the Tower, where the king was.⁶⁵ On this day they sent messengers to St. Albans, who arrived in the evening. During the celebration of matins on Friday morning the townsmen went to the abbey to speak with the abbot. Men had come in great haste from Barnet, who said that the commons ordered the best armed men of 'the communes' of Barnet and St. Albans to hurry to London,⁶⁶ adding that in the event of refusal the Londoners would come 20,000 strong and burn the town.⁶⁷ On this the abbot commanded his villeins to go to London at once, dispatching them with a band of his own men-at-arms.

The men of St. Albans went straight to the rebels' head-quarters in Bow Church and began to treat for their enfranchisement.⁶⁸ It was proposed that new bounds should be fixed round St. Albans, within which the townsmen could pasture their beasts freely; burgesses should have free fishery in certain

⁵⁴ Chan. Inq. p.m. 6 Edw. II, no. 38; 2 Ric. II, no. 34.

⁵⁵ Ibid. 35 Edw. III, pt. i, no. 3; Exch. Proc. 144, no. 33 (Herts. 18 Edw. I).

⁵⁶ Mins. Accts. bdle. 867, no. 23.

⁵⁷ Ibid. no. 8.

⁵⁸ Ibid. bdle. 862, no. 6.

⁵⁹ Ibid.

⁶⁰ Harl. MS. 6165, fol. 230-2; Mins. Accts. bdle. 867, no. 8.

⁶¹ Mins. Accts. bdle. 862, no. 6.

⁶² Ibid. bdle. 867, no. 8.

⁶³ Harl. MS. 6165, fol. 230-2.

⁶⁴ Froissart, *Chron.* (ed. Marzials), 117.

⁶⁵ Ibid.

⁶⁶ Walsingham, *Hist. Angl.* (Rolls Ser.), i, 454-5; *Gesta Abbatum* (Rolls Ser.), iii, 289-90.

⁶⁷ Walsingham, *Gesta Abbatum*, iii, 296.

⁶⁸ Walsingham, *Hist. Angl.* i, 467.

SOCIAL AND ECONOMIC HISTORY

waters and free hunting and fowling in certain lands ; they should have hand-mills at their will ; the bailiff of the liberty was to have no powers in the town ; the monks should be made to surrender all the bonds made by townsmen in and after 1332, all charters prejudicial to the townsmen, and other documents so numerous that Walsingham calls them 'all the muniments, to put it briefly.'

At this meeting leaders of different opinions began to stand forward. One invited Wat Tyler to come to St. Albans and to burn the abbey and kill the monks if they refused the demands. One, perhaps William Grindecobbe, who had something of the mind of a statesman, advised the villeins to obtain a royal writ ordering the restoration of the burghal privileges of the time of King Henry.⁶⁹ Grindecobbe is mentioned by name at this point as accusing the monks to Wat Tyler of oppressing the commune of the town and keeping back the wages of poor men and servants. Tyler, it was reported, promised to come to St. Albans. Apparently Grindecobbe prevailed. Walsingham says that he obtained the writ. Like others, he probably went to the places in London where the king's thirty secretaries⁷⁰ were drawing up the Letters Patent at the villeins' dictation. The St. Albans writ was evidently inspired by one of the townsmen. It ordered the abbot to give the burgesses the charters of King Henry as to common pasture and common fishery and other commodities. Grindecobbe probably began the business and left it to be finished⁷¹ by Richard de Wallingford, for Grindecobbe, with W. Cadington, a baker, reappeared in St. Albans that evening.

All that day, from matins to nones, the great household at the abbey had waited for any news. The prior and one or two others fled. The townspeople prepared now to act for themselves ; they came to the abbot no longer. John Eccleshall, the 'first rebel,' made proclamation to the men of St. Albans, who now took their old title of burgesses, to rise, and thereupon they summoned the vills around to send their representatives, who were to bring gentlemen with them if they could.⁷² Inflammatory speeches and threats were made. John Wayt declared 'they would never have their liberties until they had pulled down all the manors round the abbey and half the abbey'; another, Gilbert Tayleour, said that if any man were killed through this rebellion the abbot's manors should be burnt and the abbey pulled down.^{72a}

On the following day representatives of the neighbouring vills were coming in.⁷³ Men were there from Cashio,⁷⁴ Rickmansworth, Tring, Abbot's Walden, Redbourn,⁷⁵ Norton, Northaw and South Mimms, Abbot's Langley, Sandridge, Tyttenhanger, Codicote, Shephall, Westwick, Newnham⁷⁶ and Berkhamstead.⁷⁷ The men of Redbourn 'dragged along with them' three gentlemen called William Grescy, William Erle and Thomas Norton.⁷⁸

⁶⁹ Walsingham, *Hist. Angl.* i, 467-8.

⁷⁰ Froissart, op. cit. 123.

⁷¹ cf. the king's words at Mile End as reported by Froissart, loc. cit. : 'Now therefore return to your homes . . . leaving two or three men from each village to whom I will order letters to be given, sealed with my seal, which they shall carry back with every demand you have made fully granted.'

⁷² Walsingham, *Hist. Angl.* i, 471. The chronicler uses the word 'procuratores,' with which he must have been familiar in connexion with Parliament.

^{72a} *Coram Rege R.* 482, m. 27 ; 485, m. 33.

⁷⁴ Walsingham, *Gesta Abbatum*, iii, 325.

⁷³ Walsingham, *Hist. Angl.* i, 471.

⁷⁶ *Ibid.* 326-8.

⁷⁶ *Ibid.* 330.

⁷⁷ *Ibid.* 287.

⁷⁸ *Ibid.* 328-30.

A HISTORY OF HERTFORDSHIRE

The leaders threatened to destroy the conventual buildings and the granges of outlying manors of the abbey,⁷⁹ and the house of the sub-cellarer in the market place was pulled down by the mob.⁸⁰ William Grindecobbe and William Cadington incited the people to break into the abbot's warrens, and on Saturday, 15 June, crowds went out and tore down the gates and palings of the warrens at Shropshire Lane, Sopwellbury, Monewood and Faunton Wood.⁸¹ At the same time the abbot's prison was broken open and 'a certain unknown man' was beheaded, the only act of bloodshed committed by the insurgents.⁸²

All this happened in the time of waiting. Nothing could be done until the royal writ could be delivered to the abbot. Before midday, however, Richard de Wallingford,⁸³ with William Berewick and J. Garlek, bearing the king's flag,⁸⁴ brought the writ to the abbot, the terms of which left the abbot no alternative but to grant the demands of the villeins. He surrendered the bonds given by the burgesses in 1332 and the archdeacon's records, containing, perhaps, the suit against John the Marshal, all of which were burnt at the beautiful Eleanor cross which stood in the market place. In accordance with the king's letters, fresh charters were granted to the townsmen. At this point, however, a strange demand was made. The oldest men, those who could remember the troubles of 1327 and 1332, maintained that there was an important charter of liberties of King Offa,⁸⁵ written on parchment in letters of blue and gold,⁸⁶ which was withheld by the abbot. The monks denied the existence of the document, probably well knowing that such a grant could not have been made, as St. Albans town did not then exist. But the townspeople repeated their demand, and to pacify them the abbot promised them a new charter in its place.⁸⁷

In the meantime the crowd had attacked the abbey buildings. The parlour in which the millstones seized in 1332 were used as a pavement⁸⁸ was wrecked, and the houses of some of the abbey officials obnoxious to the townsmen were destroyed.⁸⁹

The villeins procured flags as symbols of royal authority.⁹⁰ The king's words at Mile End must have been known: 'You, my good people of Kent, shall have one of my banners, and you also of Essex. . . . Suffolk and Cambridge shall each have one; and I pardon you all for what you have hitherto done, but you must follow my banners, and now go home.'⁹¹

Richard de Wallingford brought such a banner from London, and Thomas Payntour, one of the St. Albans villeins, painted a flag with the royal arms and gave it to one John Dene to carry.⁹² Under this royal flag the villeins made proclamation that watches should be kept round the abbey. They issued a further proclamation, possibly inspired by William

⁷⁹ Coram Rege R. 482, m. 27; 485, m. 33.

⁸⁰ Walsingham, *Hist. Angl.* i, 470; *Gesta Abbatum*, iii, 288-90.

⁸¹ Walsingham, *Gesta Abbatum*, iii, 288-90.

⁸² Coram Rege R. 483, m. 18. Walsingham accuses the villeins of beheading others, but does not substantiate his accusation (*Hist. Angl.* i, 471; *Gesta Abbatum*, iii, 288, 304).

⁸³ Walsingham, *Hist. Angl.* i, 472.

⁸⁴ Coram Rege R. 482, m. 26 d., 28.

⁸⁵ Walsingham, *Gesta Abbatum*, iii, 365.

⁸⁶ *Ibid.* 292; *Hist. Angl.* i, 475.

⁸⁷ Walsingham, *Gesta Abbatum*, iii, 294, 370; *Hist. Angl.* i, 476-7.

⁸⁸ See above.

⁸⁹ Walsingham, *Gesta Abbatum*, iii, 292; *Hist. Angl.* i, 475; Coram Rege R. 484, m. 18; 482, m. 26, 28; 485, m. 23 d., 33.

⁹⁰ See above.

⁹¹ Froissart, op. cit. 123.

⁹² Coram Rege R. 482, m. 26.

SOCIAL AND ECONOMIC HISTORY

Grindecobbe, to all men of the county to come armed 'to reinforce them in the maintenance of the rights of the king and the commons.'⁹³

About dawn on Sunday the news reached St. Albans that Wat Tyler was dead and the king's letters had been annulled.⁹⁴ A troop of the king's knights rode in early in the morning to proclaim his peace and to give letters of protection to the abbot.⁹⁵ Nevertheless the townsmen came at the due time to seek for the charter. The 'greater villeins' were admitted to the abbot's chamber,⁹⁶ where their demeanour was more conciliatory than it had been on Saturday.⁹⁷ The abbot then sealed the charter, dated 16 June, granting to the burgesses of the borough of St. Albans the liberties which had been claimed at Bow Church.

The villeins had won their cause and had obtained pardon for the means they had used. They went round the town in procession with cart-loads of bread and ale, which they consumed at the bounds.⁹⁸ Stopping at the Cross, they proclaimed the new charter, the Mile End conditional pardon and the royal protection to the abbey.⁹⁹

The abbot inspected the general charter of freedom granted by the king.¹⁰⁰ Then the various 'representatives' of the outlying villis had to be dealt with. To the people of Rickmansworth the abbot granted that all tenements within certain bounds in the vill should be free, and that the tenants should be able to give, sell or assign them freely, paying the annual rent then paid for all services. The tenants should have free fishing and free common of pasture in certain places, paying 3*d.* a head yearly. But on the same day the villeins 'extorted' a new charter, enlarging the boundaries of their liberties and commuting suit of court.¹ The tenants of Barnet and South Mimms were granted all their liberties and free customs, as in the charter of King Richard, and the right to sell their lands freely by charter without licence.² The men of Redbourn demanded a charter like that of Rickmansworth and freedom from all servile dues to the manor. The abbot promised the charter of manumission, but for the rest they were to return on the following Thursday.³ The charter of Tring merely freed the tenants from all tolls within the liberty.⁴ The men of Abbot's Walden, Norton, Northaw, Abbot's Langley, Sandridge, Tyttenhanger, Codicote, Cassio, Watford, Westwick and Newnham also received charters.⁵

In the country the rebels, especially those on the demesnes of the monastery, were evidently closely connected with the men of St. Albans. These latter boasted that they had compacts with thirty-two villis,⁶ and 2,000 country people are said to have been in the town on the Saturday morning. The demesne seems only to have risen after the town. The men of Watford probably began to riot on Friday. They attempted to get the justices' files of warrants, evidently with the intention of burning them.⁷ Many men at Barnet went off to St. Albans. Those who remained demanded the Court Rolls,⁸ no doubt with the intention of destroying

⁹³ Walsingham, *Gesta Abbatum*, iii, 294 et seq.

⁹⁵ Walsingham, *Hist. Angl.* i, 479.

⁹⁷ Walsingham, *Hist. Angl.* i, 481.

⁹⁹ Walsingham, *Hist. Angl.* i, 482-3.

¹ Walsingham, *Gesta Abbatum*, iii, 326.

³ Walsingham, *Gesta Abbatum*, iii, 328-30.

⁶ *Ibid.* 330.

⁷ *Coram Rege R.* 485, m. 33.

⁹⁴ Froissart, *op. cit.* 128-30.

⁹⁶ Walsingham, *Gesta Abbatum*, iii, 318.

⁹⁸ Walsingham, *Gesta Abbatum*, iii, 320.

¹⁰⁰ *Ibid.* 484.

² Dugdale, *Mon.* ii, 240.

⁴ *Ibid.* 317.

⁵ *Ibid.* 317, 325, 330.

⁸ Walsingham, *Gesta Abbatum*, iii, 328.

A HISTORY OF HERTFORDSHIRE

them. At Redbourn the villagers broke down the ditch of the prior's meadow, which they claimed as their common pasture.⁹ At Tring disorder seems to have spread from the abbey tenants to those of the Archbishop of Canterbury.¹⁰ The men of Abbot's Walden used the opportunity in the same way, and ejected a widow from a tenement in Bishop's Hatfield.¹¹ Outside the abbot's demesne the revolt can be traced along the Colne and along the Lea. The part taken by the men of Berkhamstead at St. Albans is already known. But on the Sunday, while these men were away, others 'rebelled' and went to Ashridge and burnt the books and muniments of the rector of that monastery; then, going on to King's Langley, they ejected a certain J. Marlere from his free tenement.¹² King's Langley was far from peaceful. A crowd of the most considerable villeins assembled and burnt the Court Rolls. At Puttenham also there were disorders and at Aldenham some of the Court Rolls were destroyed.¹³

On the other side of the county the lead of St. Albans was naturally not felt. There was traffic along the Lea with London, Essex and Kent, and here news of the revolt must soon have arrived. Disturbances occurred at Cheshunt on Friday. At Waltham Cross on the same day riots took place and a man was beheaded.¹⁴

The judges came to St. Albans with fifty lances on 28 June.¹⁵ The villeins had now to show what passive strength they had, to stand by one another. William Grindecobbe was still intrepid. He argued with the others: 'We are bound by pact with the vills round about and they will help us in need.'

Sir Walter atte Lee summoned the townfolk to meet him, calling them 'lords and friends.' He impanelled a jury for the next day, but they refused to accuse anyone.¹⁶ Even when he ordered them to return the charters they excused themselves. When he met them again they were strengthened by 300 bowmen from the vills round, especially Barnet and Berkhamstead. Grindecobbe was deceived, not in the faith of his allies, but in their effectiveness. For Sir Walter atte Lee had given secret orders to the abbot's squire, Richard Perers, and three others, who arrested Grindecobbe himself, William Cadington and John Barber, and quietly carried them to Hertford jail, whither the judge betook himself. When this was known excitement and fear spread through the town. The king recalled the letters of manumission on 2 July,¹⁷ and it must have been about this time that the country vills surrendered their charters and put themselves in the abbot's mercy.¹⁸ The villeins began to meet secretly in places outside the town¹⁹ from this time until Friday, 12 July, when the king arrived.²⁰ Grindecobbe was released on bail and came to St. Albans. He met his friends and addressed them. This time his insight was clear. He told them to behave as though he were already executed.²¹ But the townsmen

⁹ Walsingham, *Gesta Abbatum*, iii, 328-30.

¹⁰ Coram Rege R. 485, m. 10; cf. the farmer of Kingsbury, *infra*. ¹¹ Coram Rege R. 485, m. 24 d.

¹² Ibid. 482, m. 34.

¹³ Ct. R. (Gen. Ser.), portf. 177, no. 47.

¹⁴ Coram Rege R. 482, m. 34; 484, m. 18.

¹⁵ Walsingham, *Hist. Angl.* ii, 22.

¹⁶ Ibid. 23-5.

¹⁷ *Cal. Pat.* 1381-5, p. 27.

¹⁸ Walsingham, *Hist. Angl.* ii, 29.

¹⁹ Ibid. 26.

²⁰ Ibid. 28; Réville, *Le Soulèvement des Travailleurs d'Angleterre en 1381*.

²¹ Calling them 'concives' (Walsingham, *Hist. Angl.* ii, 27).

SOCIAL AND ECONOMIC HISTORY

were acting on plans which were not Grindecobbe's. He was sent back to Hertford on Saturday, 6 July, and the villeins went to make their offer to the abbot on the same day.²² They would give back the charters and an old book of pleas between the townsmen and the abbot, and would pay £200 damages.²³ The villeins even employed a lawyer, Sir William Croyser, to plead with the abbot that they should be allowed to replace the parlour pavement and rebuild the destroyed houses.²⁴ Many of the greater villeins bound themselves under seal to pay. They tried to excuse themselves for not restoring the charters by their fear of the men of the countryside. The abbot promised to make no complaint of them to the king, and the charters were given up to him and the parlour repaved.

On Friday, 12 July, the king came into St. Albans with Sir Robert Tresilian and his other judges. The sessions began in the Moothall on the 13th.²⁵ John Ball was executed in the town on the 15th.²⁶ Tresilian called upon the jury of the townsmen to indict, but at first they would not do so. Their resistance must have held over the Monday, but at last they gave way. A second and a third jury were afterwards called up. The leaders were apparently indicted at once. During this space the king issued his commission to John Ludwiche, Richard Perers, the abbot's squire, and others to make proclamation in Hertfordshire to all tenants of the abbey, bond and free, that they should do their old service as before the disturbance and to arrest those who did not. Then he took fealty of all men.²⁷ On Tuesday, 16 July, presentment was made that Grindecobbe and others seized to themselves the royal power and broke and threw down the house of the abbot called the Thwarthoverhouse, and also the houses of three others, and broke the abbot's prison. Grindecobbe pleaded he was not guilty, but the jury found him guilty, and he was condemned to be drawn and hanged.²⁸ There were condemned also William Cadington, J. Barber and fifteen others.²⁹

Many of the greater townsmen were imprisoned, including Richard de Wallingford, W. Berewick, T. Payntour and others. A certain number from the countryside, given as eighty by the chronicler, were also imprisoned. The trials of the townsmen were concluded at Westminster during the autumn. Wallingford, Berewick and Payntour were pardoned on 28 October.³⁰ A carpenter accused of pulling down the houses was acquitted, and others received their pardons one by one through the winter and spring.³¹

But the juries were not quite tamed by Tresilian. They indicted the abbot of a charge of having ordered them to join the rebels at London.³² The judge ruled that, though the fact was true, the motive saved it from being indictable. The villeins had no vent but in complaints to the men of the royal household who were quartered upon them that the abbot had

²² Walsingham, *Hist. Angl.* ii, 28.

²³ *Ibid.* 28-9.

²⁴ *Ibid.* 30.

²⁵ *Ibid.* 31. On the first day of the Dog-days.

²⁶ *Dict. Nat. Biog.*

²⁷ Walsingham, *Hist. Angl.* ii, 38.

²⁸ Chan. Misc. bdl. 62, file 3, no. 95. The chronology of the chronicles appears to be wrong when compared with the dates given in the judicial records. But in the presentments of the juries, sometimes made months later, the events of the different days are often confused.

²⁹ Walsingham, *Hist. Angl.* ii, 36.

³⁰ *Coram Rege R.* 482, m. 26-26 d.

³¹ *Ibid.* 482, m. 27-8; 484, m. 18; 485, m. 23 d.

³² Walsingham, *Hist. Angl.* ii, 37-8

A HISTORY OF HERTFORDSHIRE

oppressed them, who were free men, so that no one might have a hand-mill in his house, but, as villeins do, they were forced to grind at the abbot's mills. Proclamation was made against this talk as a 'slander against the Abbot.'

Of the country people imprisoned on the indictment, all seem to have been pardoned.³³ Even the manslaughter at Waltham Cross was forgiven.³⁴ The rebels at Langley were dealt with by the manorial court. Their villein tenements were seized into the lord's hand in January 1383.³⁵ But by the next Whitsuntide they seem to have been restored.³⁶ The chief rebels were then heads of tithings, and later one or two held offices, like that of rent-collector.

In all this certain classes and individuals stand out. Grindecobbe is the most vivid and the most interesting. Presumably he came of the burgess and rebel family of this name.³⁷ His brother was a cloth-dyer in London. He doubtless had some education at the grammar school, and he is said to have had kinsmen in the abbey, though he quarrelled and even came to blows with the monks. He must have been a man of some property. He held a house in Holywell Street, and another with a garden and dovecot in 'Eywode Lane,'³⁸ worth 13s. 4d. a year, and these his widow was allowed to hold after his execution.³⁹ His other possessions were a house and garden on Holywell Hill, a cottage called Copped Hall and 2 acres of land,⁴⁰ apparently let for 7s.⁴¹ Grindecobbe evidently knew something of the earlier revolts. But his organization was on a larger scale and his plans show political ability. They are marked by his faith in class combination. So far as our information goes, and it comes from his bitterest enemies, Grindecobbe endeavoured to keep his followers within the law and had the true instincts of a leader in his willingness to sacrifice himself for his cause.

Richard de Wallingford is only known by repute as the richest villein.⁴² Both these leaders may have learnt something from the 'old men' more valuable than the tale of Offa. Benedict Spichfat was one of them, just possibly the Benedict Spichfat of 1313.⁴³ Henry 'de Porta' was probably a descendant of the fighting Henry de la Porte of 1274-5; Richard Bude and William atte Halle were two other elders who stirred up the memory of the charter.⁴⁴ These men were the leaders, but the whole town from the highest to the lowest was evidently alive with discontent.

In the country there was the same readiness to rise at the call of the town. The men who rebelled seem to have been tenants of standing and substance. At King's Langley hardly one of those mentioned but was a chief-pledge. John Marlere, a leader, held both free and villein lands.⁴⁵ Four years after the revolt John Carter set up a plea in the lord's court that he was not of villein condition. The homage had a day to inquire, as it was witnessed that Carter had acknowledged himself to be a villein on oath; the question was whether this was before a judge of record. The homage

³³ *Coram Rege R.* 484, m. 18; 485, m. 23 d.

³⁵ *Ct. R. (Gen. Ser.)*, portf. 177, no. 47.

³⁸ *Cal. Pat.* 1388-92, p. 22.

⁴⁰ *Cal. Pat.* 1388-92, p. 22.

⁴² Walsingham, *Hist. Angl.* i, 472.

⁴⁴ *Ibid.*

³⁴ *Ibid.*

³⁷ See above, the rising of 1313.

³⁶ *Ibid.*

³⁹ *Chan. Inq. p.m.* 7 Ric. II, no. 93.

⁴¹ *Pat.* 7 Ric. II, pt. ii, m. 1.

⁴³ Walsingham, *Gesta Abbatum*, iii, 365.

⁴⁵ See above.

SOCIAL AND ECONOMIC HISTORY

did not know, and successive adjournments for three years did not enlighten them. He must have been fairly prosperous, for in 1386 he took a tenement of the lord on a year's lease, paying 10s.⁴⁶

The disputes between the abbot and the townsmen of St. Albans throw a light on the conditions of the tenants of mesne boroughs. There was in the 13th century no definite tenure or custom which exactly distinguished a borough from an ordinary vill,⁴⁷ but the legislation of Edward I tended to a greater exactitude in legal definition. Burgesses, lawyers of the day would probably argue, must be entirely free; those who were not so in all the incidents of their tenure were unfree and came under the general term of villeins. At St. Albans multure claimed by the abbot was a base service^{47a}; hence the contentions that the inhabitants were villeins, and for this reason the battle raged so furiously around this particular point. St. Albans had been established as a market town in the 10th century, was called a borough⁴⁸ in the Domesday Book, had four Frenchmen and forty-six burgesses in 1086, and had been confirmed to the abbot as a borough⁴⁹ by Henry II. Further, in 1253 a charter,⁵⁰ addressed by the king directly to the 'good men' of St. Albans, practically acknowledged their burghal rights. Yet when the borough had attained a considerable degree of prosperity by the latter half of the 13th century, greatly by the encouragement of the abbey, its progress seems suddenly to have provoked the intense disapproval of the abbots as overlords, who opposed every symptom of independence with all the vindictiveness they could exercise.

The restraint the abbots attempted to impose was harmful to trade and was opposed in spirit, if not in deed, to the treatment the early burgesses had received. There seems also to be evidence that the friction caused by the abbot's jealousy of the increasing independence of the townsmen was accentuated by their opposition to the penitential discipline and probate jurisdiction of the Church. We know that in 1381 the bitterest complaints were made against the archdeacon's disciplinary jurisdiction, and his records were eagerly sought out and destroyed by the mob.⁵¹ Similar difficulties were being experienced at many other towns formed under the shadow of a great church. Bury St. Edmunds particularly is a case in point, but at Sherborne, Rochester, Wells and elsewhere disputes and disturbance of almost, if not quite, equal importance had arisen.

Discontent spread from the towns to the country, and all the disturbing factors gathered strength with the dearth of labour after the Black Death, and only awaited an opportune moment to show themselves. In the rebellion of 1381 it was the rural population that was mainly aggrieved. The townsmen had their grievances, which in the Hertfordshire market towns were mostly agrarian. Their better education and business training, however, enabled the townsmen to play the part of leaders and organizers, and it is this organization which is perhaps one of the most interesting features of the rebellion.

⁴⁶ Ct. R. (Gen. Ser.), portf. 177, no. 47.

⁴⁷ Pollock and Maitland, *Hist. of Engl. Law*, i, 635 et seq. The editor is responsible for this and the two following paragraphs.

^{47a} Compare case in Maitland, *Bracton's Note Bk.* ii, 131-2. Here it was decided in 1222 that, the defendant being a free man, multure was not due from him.

⁴⁸ *V.C.H. Herts.* ii, 477.

⁴⁹ *Ibid.* 478.

⁵⁰ *Ibid.*

⁵¹ Walsingham, *Gesta Abbatum*, iii, 308.

A HISTORY OF HERTFORDSHIRE

The summons by the St. Albans townsmen to the country vills must have asked for representatives if 'procuratores'⁵³ is to be taken literally, and of course the procedure of election was familiar. Actually the countrymen came in troops, not as representatives; about forty came from Berkhamstead.⁵³ There may have been secret arrangements with the representatives of the vills beforehand. 'We have pacts with thirty vills'⁵⁴; the villeins of Barnet were bound to them by oaths (*foederati*).⁵⁵ Possibly the oath was to maintain the rights of the king and of the Commons, as the proclamation made by the townsmen ran. This 'federating' extended not only to vills in the liberty of the Abbot of St. Albans, for Berkhamstead and King's Langley at least were outside. It would be interesting to know whether Cheshunt and Waltham Cross had any communication with the rebels on the western side of the county, but it is more probable that they were in touch with the Essex rising.

The revolt was not quelled without reprisal. There were mysterious fires in St. Albans. A certain Bidwell made a false confession that Henry Grindecobbe, William's brother, had suborned him to fire the abbot's prison.⁵⁶ But after this the resistance of the townsmen grew weaker and weaker. Barnet was the first to act, and that not until nearly forty years after the revolt. In the summer of 1417 Johne atte Mille and John Penne and other copyholders entered into a confederacy binding themselves to resist the abbot and his servants. On the plea that they held land freely they withheld certain services—suit to the abbot's court, heriot on death or surrender, the determination of pleas of tenements and contract in the abbot's court, and the buying of a licence for all alienation of land on demise for a term. These are obviously the ordinary villein dues. The demand was for freedom of tenure, and was in effect and partly in wording the same as that of 1381⁵⁷; and in this case, too, the demand came from the prosperous. One John Beauchamp, the builder of all the ancient part of Barnet Church which now remains and a London merchant, had a large holding of a house and a cottage with gardens, 30 acres arable, 29 of meadow and 4 of wood. He paid 19*s.* 9*d.* a year and carried half a cart-load of fuel to the abbot's hospice in London. The services of the other tenants were similar. Many of the tenants lived away—one, indeed, in London.⁵⁸ The case was tried at the autumn assizes, and the villeins were judged guilty and imprisoned until October 1427, when they paid a fine of 6*s.* 8*d.* each.⁵⁹

At St. Albans in 1434 there was a recrudescence of the old spirit of resistance. Abbot John of Wheathampstead had just returned from the Council of Siena. A 'great crowd' of the villeins came to him to accuse the monks of withdrawing the bare rights of the town as to boundaries 'and other liberties justly due.' A day was appointed (not without references by the abbot to the downfall of the men of Barnet and to Dathan and Abiram) and the villeins brought their 'supplication.' They asked for common of pasture to certain points round the town, and in Barnet Wood, Frithwood

⁵² Walsingham, *Gesta Abbatum*, iii, 287.

⁵⁴ Walsingham, *Gesta Abbatum*, iii, 380.

⁵⁶ Walsingham, *Gesta Abbatum*, iii, 362, 364.

⁵⁸ Assize R. 340, m. 3-6.

⁵³ Coram Rege R. 482, m. 28.

⁵⁵ Walsingham, *Hist. Angl.* i, 472.

⁵⁷ See above.

⁵⁹ *Ibid.*

SOCIAL AND ECONOMIC HISTORY

and other places and along the high roads; also for right of way through Eywode in two places and through Faunton Wood. The abbot's councillors found this petition to be identical with that of 1381 (as it is, with very significant omissions), and with this discovery they struck terror into the villeins, who stood amazed and said no more for that time.⁶⁰ The important feature in both these cases is that the demands had been growing less and less ever since 1274. They had now reached the lowest stage—freedom of tenure and preservation or perhaps extension of common rights. These, too, are rights more useful to the agriculturist than to the merchant, suggesting that the towns were already suffering from the decay which is very apparent at Hertford at this time.

In the 15th century the Hertfordshire towns were not buying privileges. Possibly the wars affected them. They were poor and half-populated. It was not until the 16th century that they began to seek charters again, this time from the king. After 1563 economic advantages under the Statute of Artificers were obtained from incorporation. This was probably one of the reasons why the men of Berkhamstead procured a charter in 1616.⁶¹

At the beginning of the 15th century the population was very scanty both in urban and in rural districts. In 1428 Codicote, Graveley, Chesfield, Ayot Montfitchet and Digswell each had less than nine householders.⁶² At Bygrave there were seven, at Clothall six, at Radwell seven, and eight at Throcking.⁶³ Bramfield and Wakeley were apparently depopulated.⁶⁴ Of urban parishes Stapleford had only nine householders, Eastwick seven, and even around St. Albans, in the district of St. Julian's Hospital, there were very few.⁶⁵ The parishes of St. Mary and St. Nicholas at Hertford had not twenty householders between them.⁶⁶ Hertford did not recover its prosperity until far into the 16th century, as the decay of the markets and fairs shows. The same tale is true of Hitchin. In 1526 the tolls were let for £2 12s. 8d.⁶⁷ Thirty years later they only fetched 20s.⁶⁸ Hitchin was a 'great thoroughfare and scattered parish with over a thousand houselyng folk.'⁶⁹ At Berkhamstead the May Fair died out⁷⁰; at Markyate, too, from 1480–1 no fair was held, and in 1526 the market tolls were worthless.⁷¹ In 1548 the market town of Baldock was much decayed.⁷² The towns on the east of the county seem to have struggled along better than those on the west. Owing to the traffic on the Great North Road, in 1545 Ware was 'a great parish to the number of 1,200 houselyng people.'⁷³ At Stortford there were 500 housling folk, being a great thoroughfare.⁷⁴

In the 15th century one would look for guilds in the town records, and there were plenty in Hertfordshire. In most instances, however, we only find reference to their religious side. There may have been a guild merchant at Berkhamstead from the 12th century; but it is merely surmised from

⁶⁰ Amundesham, *Ann. Mon. S. Albani* (Rolls Ser.), i, 187. As late as 1601 the men of St. Albans still ground at the 'Abbot's mill.' In 1556 ten men had set up mills of their own, to the queen's loss £16 13s. 4d., although in the abbot's time they had ground at his mill. 'Let it be well looked to' (*Herts. and St. Albans Archit. and Arch. Soc. Trans.* ii, 15; Aug. Off. Misc. Bks. cccxc, fol. 24b et seq.).

⁶¹ *V.C.H. Herts.* ii, 172.

⁶² *Feud. Aids*, ii, 454.

⁶³ *Ibid.*

⁶⁴ *Ibid.*

⁶⁵ *Ibid.* 456, 459.

⁶⁶ *Ibid.* 461; v.s. borough.

⁶⁷ *Mins. Accts.* 18 & 19 Hen. VIII, no. 1584.

⁶⁸ *Aug. Off. Misc. Bks.* cccxc, fol. 38b.

⁶⁹ *Chant. Cert.* 27, no. 14; 20, no. 72.

⁷⁰ *V.C.H. Herts.* ii, 173.

⁷¹ *Mins. Accts. bdle.* 1123, no. 6.

⁷² *Chant. Cert.* 27, no. 14.

⁷³ *Ibid.* 20, no. 66.

⁷⁴ *Ibid.* no. 67.

A HISTORY OF HERTFORDSHIRE

some functions of the religious fraternity of St. John the Baptist.⁷⁶ The inquiry of 1388 found a few gilds in Hertfordshire. At Barkway the fraternity of the Blessed Mary had existed before 1303. As its brethren and sisters agreed to pay $\frac{1}{2}d.$ a week for masses in honour of the Virgin, to find lights for her image and to attend one another's funerals, it seems to have been religious in purpose. At Hertford there was a fraternity of St. John the Baptist founded about 1375 by twelve pious men, of whom seven were still alive in 1388. They kept tapers burning before the image of St. John on feast days, but otherwise had no duties or funds. The gild of Holy Trinity at Codicote had an alderman and 'bedell,' so that it may have been fairly large; but we know no more of its objects. At Waltham Holy Cross the 'two masters of the little company ordained to the honour of God and Our Lady' declared their purpose to be the maintenance of tapers at holy seasons and the sustentation of a chaplain in the Lady Chapel.

The wool trade of Hertfordshire was small. Before the year 1396 and the first quarter of 1397 the king's ulnager only accounted for 139 $\frac{1}{2}$ cloths.⁷⁶ In 1398, among the sixteen men of Royston who had thirty-eight cloths, there were three drapers, perhaps the merchants' middlemen.⁷⁷ The wool trade must have gone through phases like those of the corn trade—the struggle of merchants for free buying. In the 16th century the justices had to restrain the broggers and engrossers of wool, like the badgers and engrossers of grain.⁷⁸ But the cloth merchants can never have been a very strong body. In the 15th century, or early in the 16th, the drapers, mercers and haberdashers of St. Albans seem to have formed a company or gild. But we know nothing of this body until after its amalgamation with others, possibly before 1556.⁷⁹ It became one of the four companies of the 17th century and of the two companies surviving after 1664.

There is much evidence as to the corn and malt trade, which was probably the most important in the county. Formerly corn and malt had been carried on pack-horses along the great roads of eastern and western Hertfordshire and by the Lea and other rivers. The trade increased all through the 16th century, because of the increasing demand in London. It was extremely difficult to keep the capital supplied, and when this was done the home counties were sometimes starved and provincial prices always raised. The problem of a remedy puzzled the Privy Council. The corn trade had been in the hands of travelling country dealers called 'badgers,' who bought in the country markets and sold to the London brewers and bakers. About the middle of the 16th century some of the badgers had created a very strong position. They had the London brewers in their pockets; to some they had lent £1,400 or £1,500 worth of grain, so that the debtor dared deal with no one but the creditor. They had also laid hands on the transport; some had a hundred hired horses carrying to London along the Great North Road daily.⁸⁰ As they thus controlled supplies both in London and the country, they controlled prices.⁸¹ They bought quantities of corn in advance of delivery, so that the country markets were very small and the supply for London very limited. If they kept

⁷⁶ *V.C.H. Herts.* ii, 171.

⁷⁶ *Exch. Accts. bdle.* 342, no. 11.

⁷⁷ *Ibid.* no. 12.

⁷⁸ *Cal. S. P. Dom.* 1547-80, p. 555.

⁷⁹ A. E. Gibbs, *Hist. Rec. of St. Albans*, 14, 17.

⁸⁰ Lansdowne MS. 32, fol. 104.

⁸¹ *Ibid.* fol. 107.

SOCIAL AND ECONOMIC HISTORY

back as much as 4,000 horse-loads (the load being reckoned at five Winchester bushels)⁸² it served their turn to raise the price in the City. This monopoly was at the expense of the baker, the brewer and the consumer. But the whole trade was disturbed. The improved navigation of the Lea under the Act of 1571⁸³ had transferred the freights from the road to the river, and the carrying branch of the trade had taken a fresh form. The trade was so profitable that millers and speculative buyers were drawn in. Finally the rich brewers and bakers of London were invading country markets and leaving off dealing with country agents.

In 1573 the council charged the justices to see that corn was brought to market, that no deceit was used to raise prices and that no farmers or unlicensed badgers bought⁸⁴; they were even to call in and revise the licences of those badgers who bought up corn to sell it dearer in other markets.⁸⁵ In 1580 they forestalled the market of Hertford by buying up all the corn.⁸⁶ The badgers infected others with their habit of buying outside the market. At Hoddesdon in 1581 the people were forbidden to sell corn out of their shops or in any place but the market, and a licence was required of every purchaser for resale. Anyone offering more than the usual rate was to be brought before the justices.⁸⁷

There was a second type of grain merchant, the loader or carrier. His real business was to carry the corn from the market to London, but he often bought and dealt as well.⁸⁸ But most were poor and used old horses and carried for other men.⁸⁹ The special area of the carrier was from Ware southward; those of Enfield and Cheshunt had the whole carrying trade to London for the counties of Essex, Bedfordshire and Cambridgeshire.⁹⁰ Cheshunt was the *entrepôt* for the grain of those counties.⁹¹

When the Lea was practically reopened for navigation the corn traffic deserted the road between Cheshunt and London. The water-way was quicker.⁹² The water carriage was in the hands of twenty-two owners—three of Hertford, three of Waltham, one of Braughing, two of Stanstead, two of Broxbourne, six of Ware, two of Enfield and three of London—and they maintained over one hundred men,⁹³ ‘strong and skilled to do the Queen good service by land or sea’; a little later the bargemen had increased to 150.⁹⁴ The barge-owner superseded the carrier. The badgers’ control was broken.

The road carriers tried to prove that the traffic on the Lea did not improve the London corn supply. They said that a few men at London⁹⁵—four or five brewers—monopolized the increase.⁹⁶ The other side answered not only could all the London brewers buy malt much more reasonably, but the reverse traffic from London cheapened coal and iron in Hertfordshire.⁹⁷ The final advantage told against the badgers. ‘The trade on the Lea is the only and safest means of keeping the price of meal and malt reasonable in London.’⁹⁸

⁸² Duchy of Lanc. Dep. 6 Jas. I, no. 60.

⁸⁴ *Acts of P.C.* 1571–5, pp. 108, 111.

⁸⁷ Lansdowne MS. 31, no. 28.

⁹⁰ *Ibid.* 32, fol. 104.

⁹³ *Ibid.* fol. 105.

⁹⁴ *Ibid.* 38, no. 32.

⁹⁷ *Ibid.* fol. 105.

⁸³ Stat. 13 Eliz. cap. 11.

⁸⁵ *Ibid.* 197.

⁸⁸ *Ibid.* 32, fol. 104.

⁹¹ *Ibid.*

⁹⁵ *Ibid.* 32, fol. 104.

⁸⁶ *Ibid.* 1580–1, p. 301.

⁸⁹ *Ibid.* 38, no. 32.

⁹² *Ibid.*

⁹⁶ *Ibid.* fol. 107.

⁹⁸ *Ibid.* fol. 107.

A HISTORY OF HERTFORDSHIRE

The facilities for the transport of grain did not lower the price in the county. London drew it in and the London men came down and bought the country market away from the country dealer. In 1595 the country markets were 'so troubled with the higglers (or badgers) of Middlesex and other purveyors for London' that the shire was almost starved.⁹⁹ The brewers and bakers of London gave up their dealings with the country badgers, whom they reduced to be mere carriers. They bought great quantities and paid high prices, often privately, and were protected by their freedom of London. Local badgers could not compete with them. The badgers had to buy at such a price that they could sell profitably in London at a reasonable rate. Moreover, they were bound by their licences to buy only in the market. Nevertheless, the badgers survived to carry on nefarious practices and to vex the justices of the county. In 1600 two 'lodgers' of Cheshunt bought corn in one market and sold in another, and went from barn to barn buying at the doors, so that corn could not be had in the market for ready money.¹⁰⁰

Farmers and millers were buying up for resale and no orders would prevent them.¹ The millers were protected by their landlords, for if they could grind and carry much meal to London they would pay rack-rents. The country was stocked beyond its needs with mills working for London.² In one instance a London capitalist built a mill near St. Albans.³

The noticeable points are, of course, the development of sale outside the markets, the appearance of the capitalist employer of labour and the capitalist merchant, especially the Londoner, and the development of competition in the breaking of the corn ring.

The cloth-making industry in Hertfordshire is just traceable from time to time and no more. At the beginning of the 15th century it was carried on at Ashwell, Berkhamstead, Hunsdon, Royston (which seems to have been a centre), Baldock, Knebworth, Hitchin, Codicote, Bishop's Stortford, Hertford and Ware.⁴ But the output was very small. Presumably the domestic system crept in by degrees, for there were clothiers in St. Albans in the 16th century.⁵ But, as has been already mentioned, no craft guild existed save at St. Albans. By 1554 the victuallers, mercers, shoemakers and innholders⁶ had become pre-eminent. This list shows incidentally that St. Albans was much more a thoroughfare than an industrial centre. The bakers' and brewers' companies survived until after 1586.⁷ But by the middle of the 17th century all the crafts were grouped under one or other of these four.⁸ Clearly the crafts had no very strong organization. In 1563 the Statute of Artificers, in enforcing seven years of apprenticeship, permitted merchants of corporate towns to take boys with a smaller property qualification than those of market towns.⁹ In Hertfordshire, where there were so few boroughs and so many market towns, this must have worked on the whole disadvantageously.

In the 16th century the decay of the towns gave a corresponding benefit to the rural districts. The hundred of Edwinstree affords some

⁹⁹ *Cal. S. P. Dom.* 1595-7, pp. 107-8, 126.

¹ Lansdowne MS. 76, no. 39.

⁴ *Exch. Accts.* bdle. 342, no. 11, 12.

⁷ *Ibid.* 15.

² *Cal. S. P. Dom.* 1595-7, p. 336.

⁵ Gibbs, *Hist. Rec. of St. Albans*, 17.

⁸ *Ibid.* 78.

¹⁰⁰ *Sess. R.* (Herts. Co. Rec.), i, 30.

³ *V.C.H. Herts.* ii, 393.

⁶ *Ibid.*

⁹ Prothero, *Stat. and Doc.* 1558-1625, p. 507.

SOCIAL AND ECONOMIC HISTORY

evidence on this point. The figures available illustrate, first, location of wealth in the county, and in a secondary way the location of the people. Between 1545 and 1599 the taxpayers of Buckland diminished from twenty-five to three, those of Wyddial from twenty-eight to seven, of Aspenden from twenty-six to eight, of Great Hormead from thirty-seven to nine, and of Barkway from eighty to twenty-two.¹⁰ Between 1599 and 1640 the decrease occurred at Stocking Pelham from six to two, at Anstey from fifteen to ten, at Barkway from twenty-two to sixteen, at Barley from seventeen to thirteen, at Wyddial from seven to two, and at Layston from thirteen to nine. The numbers were maintained or increased at Meesden from five to five, at Great Hormead from nine to seventeen, at Little Hormead from three to five, at Buckland from three to four, at Aspenden from eight to nine, and at Throcking from three to three.

The movement indicated in this hundred is then as follows. Between 1545 and 1599 there was a startling decrease of property owners, especially in the large places, some of which, like Great Hormead, became mere villages, from the taxable point of view. After 1599 there was a distinct increase in the wealth of the small places, but some of the market towns and larger places continued to decay. That this was true in other parts of the shire we know from the case of Berkhamstead.¹¹ Statistics for St. Albans have not been worked out, but there was a decrease of fifteen taxpayers in the middle ward between 1545 and 1599.¹² Parts of Cashio Hundred can be contrasted between 1599 and 1663, with the following results. There is a marked increase in the case of Watford, from thirty-six taxpayers to seventy-five. Elsewhere there is nothing to parallel this. At Ridge the increase was sixteen, and at Sleaf with Smallford ten. Additions from two to six are found at Shephall, Sandridge, Windridge, Hexton, Codicote, St. Michael and Park, but none of these places had as many as thirty taxpayers even in 1665. The large places—Redbourn (thirty-nine names in 1599) and Aldenham (forty-six names)—decreased slightly.¹³ The conclusion as to this hundred must be that the small places were prospering and the large ones were only just maintaining their level.

Part of Odsey Hundred seems to have a similar history between the same dates. Of the places with more than ten taxpayers in 1599 Ashwell declined from twenty-seven to seventeen, and so did Sandon from eleven to nine, Royston from sixteen to fifteen, Ardeley from nineteen to fourteen; but at Therfield the numbers rose from seventeen to twenty-one. Where the number in 1599 was under ten there was decrease at Kelshall from nine to seven, at Rushden from six to four, at Wallington from seven to four, at Cottered from seven to five, at Clothall from six to five, and at Radwell from two to one. At Hinxworth, from four to eight; at Reed, from fifteen to six; at Bygrave, from one to three; and at Bradfield, from one to one, the numbers keep up or increase.¹⁴

The impression left is that there was a startling decline in the larger villages between 1545 and 1599, and that this proceeded very slowly

¹⁰ *Herts. Gen. and Antiq.* i, 163; *Lay Subs. R.* bdle. 121, no. 264.

¹¹ *V.C.H. Herts.* ii, 172, 173.

¹² *Herts. Gen. and Antiq.* i, 225; *Lay Subs. R.* bdle. 121, no. 265.

¹³ *Lay Subs. R.* bdle. 121, no. 266, 346.

¹⁴ *Ibid.* no. 264, 339.

A HISTORY OF HERTFORDSHIRE

between 1599 and 1640 and was accompanied by an increase in the smaller places not noticeable in the earlier period. The explanation may be connected with the method of assessment, which was partly on freehold lands and partly on goods. The 16th-century shrinkage is probably due to the concentration of property in a few hands, while the accumulation of goods was not sufficient to make itself felt in the tax returns. In the 17th century the subsidy on goods touched the rich farmers.

The lease for rent only was the most active agent in the relief of the villein. Take a little group of cases just after the revolt. At Wormley one tenant paid 7*s.* 6½*d.* assize rent, and for the farm of various tenements 'late of various men' 13*s.* 9½*d.* and 3*s.* for meadow. Twenty-seven other tenants held similar holdings.¹⁵ The lord of Stevenage granted thirty-three parcels of villein land on terms of life or years.¹⁶ In 1461 Richard Huchin, one of a progressive villein family of Bengeo, surrendered villein land and received it again on lease for sixteen years.¹⁷ Presumably the exchange was profitable.

By the middle of the 16th century the usual tenures on a manor were free, customary or copyhold, and tenancy by indenture. On five out of ten manors the records of which have been examined tenants at will are also found.¹⁸ In some manors the old varied tenures still survived. At King's Langley, for instance, there were freeholders, copyholders, tenants by a commuted rent of movables, tenants by a commutation for works executed and tenants by indenture who were obviously destined to become copyholders. The progressiveness of the copyholders is proved by the nature of their quarrels with the lords. They wanted to handle their lands freely and to be able to grant leases as freely as the freeholders. The lords tried to check or control this. At Rickmansworth in 1520 proclamation was made in the court that all who had let occupied villein land and all persons having rights in such lands should come to take licence to lease their lands.¹⁹ Near by, at Croxley, all customary tenants were ordered to show their copies, and in 1535 all persons holding or demising villein land without licence against the custom of the manor were threatened with the loss of the tenement.²⁰ From about 1500 the tenants of King's Walden had been granting parcels of their land under cover of their usual rents in fee-simple at 'undersell rents so that the lord did not know his tenants and lost reliefs and fines for the undersells. In 1556 he made inquiries and cut off the undersell rents altogether.'²¹

At the manor of Wallington one copyholder, hearing that the lord had very few Court Rolls, changed his limited estate into a fee-simple and broke all the customs and encouraged the other copyholders to cut their wood.²² The custom of some manors was favourable to the tenants. An example can be given from the custom of Hexton. Copyholders might alienate their tenements, and if they divided them the rent was divided proportionately. They might lease their tenements without licence from three

¹⁵ Rentals and Surv. R. 300, held on similar conditions.

¹⁶ Mins. Accts. bdle. 872, no. 7; cf. also Weston, *ibid.* bdle. 873, no. 25. ¹⁷ Add. MS. 27976.

¹⁸ Mins. Accts. 28 & 29 Hen. VIII, no. 85; Misc. Bks. Ld. Rev. ccxvi, 1 et seq.; Aug. Off. Misc. Bks. cccxi, fol. 1-92; Mins. Accts. 31 & 32 Hen. VIII, no. 71, m. 37.

¹⁹ Ct. R. (Gen. Ser.), portf. 178, no. 5.

²⁰ Add. MS. 6057.

²¹ Add. Chart. 35428.

²² Chan. Proc. Eliz. bdle. 6, no. 6.

SOCIAL AND ECONOMIC HISTORY

years to three years up to seven years. They also had the right to cut down trees.²³

At Bishop's Hatfield the copyholders might sell any part of their tenements by a surrender; but if they occupied any customary land without copy and without licence the lord could seize it. They were not allowed to grub up bushes and fell timber at their discretion, although they not infrequently did so. They might let their copyholds on the same condition as the men of Hexton.²⁴ The lord and his copyholders were quarrelling over these points at the same time that the lord was fighting the whole tenantry on the question of commons.

The prevalence of leases is important. The long lease gave a stable under-tenure, of particular importance at such a crisis as the dissolution of the monasteries. That long leases were common, and perhaps specially on monastic land, there is a good deal of evidence, or when the holding was large and the rent high. In 1516 the manor of Bushey, the mill and warren were leased severally for thirty years.²⁵ The Prior of Royston leased two of his manors for sixty years from 1511.²⁶ As early as 1515 the Abbot of St. Albans let his manor of Norton for fifty years²⁷ and gave other long leases in 1516 and 1523.²⁸ The Abbot of Waltham let property to a Londoner for sixty-one years in 1526, and twenty-one, thirty-one and forty-one years were favourite terms. From about 1531 religious houses made rapid grants of their property in leasehold for political reasons. Clearly in Hertfordshire the Dissolution meant rather the change of ground landlord than of occupier.

Leases also gave the tenants their opportunity, in so far as they made land a commodity easily to be obtained and easily left. The result was a concentration of holdings in the tenant's hand.

The letting of the demesne shows clearly that some lords were not sheep-farming even in the early 15th century. At Weston the whole demesne, arable, fallow and pasture, was let.²⁹ So was the demesne at Baas in 1390.³⁰ At Ware, as late as 1429, 70 acres of arable were leased to a tenant, with 80 acres of poor meadow and 36 acres of pasture.³¹ At Shenley and at Bushey the manors were leased in the same way in 1429.³² The manor of Cockenach (in Barkway) is a contrast, where the Prior of Royston kept the demesnes in the open fields with folding for 200 sheep.^{32a}

Sheep-farming was not as yet a source of agrarian trouble. Inclosures had been begun, especially on the demesne, in the 14th century. These inclosures seem to have been of meadow, and possibly of pasture, but above all of arable, of which the value was quadrupled if it were several.³³ In the southern part, where the attraction of the London corn market might have been strongest, the inclosure of arable seems not to have been excessive by the middle of the 16th century. In the manor of Moor, in Rickmans-

²³ Chan. Proc. Eliz. (Ser. 2), bdle. 225, no. 102.

²⁵ Rentals and Surv. portf. 8, no. 22.

²⁷ Ibid. 32 & 33 Hen. VIII, no. 71, m. 37.

²⁹ Mins. Accts. bdle. 873, no. 25.

³¹ Chan. Inq. p.m. 7 Hen. VII, no. 57. The meadow and pasture had been let for ten years in 1423; Add. MS. 27976, fol. 17 et seq.

³² Chan. Inq. p.m. 7 Hen. VI, no. 57.

³³ Misc. Chan. Inq. p.m. file 228, no. 177 (King's Walden).

²⁴ Misc. Bks. Ld. Rev. ccxvi, 1 et seq.

²⁶ Mins. Accts. 28 & 29 Hen. VIII, no. 85.

²⁸ Ibid. m. 5; Pat. 25 Hen. VIII, pt. i, no. 44.

³⁰ Rentals and Surv. R. 300.

A HISTORY OF HERTFORDSHIRE

worth, among thirty-seven copyholders, only five inclosures of arable are mentioned.

The thirty-eighth copyhold is the pseudo 'manor' of Hampton Hall. This estate had no resemblance to a manor save that its lands were all inclosed. These inclosures were held under copies dating from 1536 to 1553.

With the inclosure of the strips went a certain amount of inclosure of the waste for arable, and hence an increase in the corn-land of the county. Taking the waste as a whole, presumably the inclosures of arable were progressing among the copyholds as well as on the demesne.

So eager was the Hertfordshire farmer for corn-land that even in the 15th century land was ploughed up for arable, and land-grabbing was common. In this direction it is that the influence of the wars was felt in the shire. They gave an opportunity to such men as Sir Robert Whittingham of Pendley in Tring. In 1448 he had ploughed half an acre of land in the tenure of Richard Gomme, one acre in the tenure of H. Russel and one acre in the tenure of Richard Clement, and had also ploughed up a common way.³⁴ Such methods, no doubt, saved Sir Robert Whittingham much trouble in rounding off his estate. This conversion on a small scale went on. Common lands were ploughed up³⁵; tenants inclosed half-acres and three or four roods.³⁶

In 1591 the homage of Astwick ordered that R. Apryce should lay open and cast down a hedge and ditch upon a common cartway, and reported that Apryce had hedged in a garden and hemp-land.³⁷ The Sawbridgeworth saffron grounds were used for grain,³⁸ so that the saffron trade perished. In 1598 the queen gave licence to a tenant of Watford to convert part of Oxhey Park into tillage.³⁹

Pasture was more difficult to handle than arable, just because the rights over it were common and indefinite. Some pasture-land was of course inclosed from of old—for example, such old parks as Berkhamstead. But in other old parks like that at Bishop's Hatfield commoners had rights. Some manors show a considerable increase in their pasture-land. At Little Wymondley the pasture had increased from 60 acres in 1424 to 100 acres in 1460.⁴⁰ But this was a large amount for Hertfordshire. There was not a large amount of natural pasture, except in the woodlands on the west. The thinness of the population and the small size of holdings had prevented a difficulty until the latter part of the 15th century. Before 1471 Sir Robert Whittingham had depopulated the hamlet of Pendley in Tring. It had been a place maintaining thirteen ploughs and many craftsmen. But Sir Robert cast down the houses, laid the land to pasture and built himself a great house where the town once stood.⁴¹ Having thus driven off the people, he would of course hold the pasture in severalty. The treatment of the pasture was negotiated between lords and tenants. In 1427-8 the Abbot of St. Albans persuaded the tenants of Tyttenhanger who held the manorial

³⁴ Ct. R. (Gen. Ser.), portf. 176, no. 121.

³⁵ *Sess. R.* (Herts. Co. Rec.), i, 20-5.

³⁶ *Ibid.* 7.

³⁷ Add. MS. 33575, fol. 13.

³⁸ Doc. of D. and C. of Westminster, 4, shelf 1, Sawbridgeworth, parcel ii.

³⁹ *Cal. S. P. D:m.* 1598-1601, p. 70.

⁴⁰ Chan. Inq. p.m. 2 Hen. VI, no. 27; 38 & 39 Hen. VI, no. 42.

⁴¹ Ct. R. (Gen. Ser.), portf. 176, no. 120. See *V.C.H. Herts.* ii, 285.

SOCIAL AND ECONOMIC HISTORY

meads and pastures in copyhold to surrender them in return for compensation and inclosed the lands as a deer park. He had also inclosed half of Tyttenhanger Heath and converted the other half into a fertile pasture.⁴² Before 1448 Sir Robert Whittingham, aiming at increasing not his arable only, had shut out the tenants from common in 80 acres which he held.⁴³

In 1576 some of the copyholders of Aldenham complained that the lord meant to inclose half of the 2,000 acres of common land. The lord contended that the plaintiffs indeed had pasture on the waste, but the tenants had never had rights of common there. He wished to use 50 acres for his house and had made an offer to the tenants. The lord was awarded the right to put 150 sheep on the common land.⁴⁴ A few years after, at Rushden, the freeholder inclosed 14 acres on which the inhabitants had had pasture with all their cattle.⁴⁵

The Countess of Bedford, farmer of the demesne meadows of the manor of Rickmansworth, withheld from the queen's poor copyhold tenants their parcels of land lying among the demesnes. The great Park and the little Park were presumably demesnes.⁴⁶

At Clothall in 1551 the lord had had 452 acres of several meadows and pasture, but his arable still lay partly in the open field.⁴⁷ At Croxley, too, the demesne pasture was all several.⁴⁸ At Northaw 140 acres of pasture had been inclosed as early as 1521.⁴⁹ But the tenants had common in the wood for all beasts. In the little estate at Stanstead Abbots in 1556, 65 acres of the pasture were apparently common and 3 inclosed, but of the 8 acres of meadow 5 were several.⁵⁰ At King's Langley the lord had 51 acres several meadow in 1556, and he disparked the rest of the park, above 600 acres of waste, for which the tenants offered 12*d.* an acre, its market value.⁵¹

In the manor of Wallington the custom was either falsely alleged or unusually favourable to the lord. No copyholders had common for sheep or cattle in the lord's demesnes or in the common fields, except in harvest time on their own ground. Nor might any copyholder have a fold; the common of feeding in the fields and the general foldage belonged to the lord. But in 1598 one copyholder led an attempt to take commons. He claimed for the copyholder the right to have a fold on his arable for the bettering of his land and common for sheep up to 120, and for great cattle in the commonable times both in the demesnes of this manor and the common fields.⁵² Tenants might be guarded by the customs as at Hexton,⁵³ Bishop's Hatfield⁵⁴ and Tring.⁵⁵ But their weakness was that these customs were only enforced by the manor court. The men of Hemel Hempstead vested the commons in trustees in 1596.⁵⁶

According to John Hales, the insurrection against the inclosures, which spread over all southern England, began by riots at Northaw and Cheshunt in 1548.⁵⁷ The tenants of these manors had risen against the inclosure of

⁴² Amundesham, *Ann.* (Rolls Ser.), i, 261.

⁴⁴ Chan. Dec. R. 66, no. 18.

⁴⁶ Aug. Off. Misc. Bks. cccxci, fol. 1 et seq.

⁴⁸ Aug. Off. Misc. Bks. cccxci, fol. 1 et seq.

⁵⁰ *Ibid.* fol. 93*b*.

⁵² Chan. Proc. Eliz. bdles. 6, no. 6; 14, no. 7.

⁵⁴ Ld. Rev. Misc. Bks. ccxvi, fol. 1 et seq.

⁵⁶ *V.C.H. Herts.* ii, 215-16.

⁴³ Ct. R. (Gen. Ser.), portf. 176, no. 121.

⁴⁵ *Sess. R.* (Herts. Co. Rec.), i, 13.

⁴⁷ Add. MS. 33582, fol. 4.

⁴⁹ *Ibid.* fol. 18*b*.

⁵¹ *Ibid.* fol. 40-54.

⁵³ *Ibid.* (Ser. 2), bdle. 225, no. 102.

⁵⁵ Aug. Off. Misc. Bks. cccxci, fol. 55.

⁵⁷ Hales, *Discourse of the Common Weal* (ed. Lamond), p. lviii.

A HISTORY OF HERTFORDSHIRE

the commons some years before this date. The peculiarity of the manor of Northaw in 1556 was the number of tenants by indenture and the large amount of land each of them held. The farmer of the manor, the Earl of Pembroke, had common with all beasts in the wood of Northaw, and every tenant of the manor had the same right.⁵⁸ The cause of the riot was probably an attempt by the farmer to limit the tenants' stint. In 1579 a similar case happened in the same villages. The men of Northaw and Mimms destroyed the pales put by the Earl of Warwick upon the commons. The rioters were sent home by Sir Christopher Hatton. Two men were hanged in consequence of this affair.^{58a}

The inclosure of lands in the 15th century marks the beginning of the change from the cultivation of the land for subsistence to commercial farming. In the 16th century there was a struggle between them, and in Hertfordshire the London buyer almost ousted the country consumer from the country markets. London wanted grain and meat, and this sharpened the tenants' desire to preserve their commons. Wool was needed locally and sheep pasture plays a small part, but the real aim of the tenants was to trade in corn and stock.

The term 'capitalist farmer' suggests men like Sir Robert Whittingham,⁵⁹ but they did not come from that rank alone. Most significant are the Londoners who took farms in Hertfordshire. In 1551 a clothworker of London held the chantry lands of Bishop's Hatfield.⁶⁰ At the same time one Edward Kimpton of Westminster held a lease of the meadows, feedings and pastures of Clothall, Yardley and Rushden. In 1552 he sold them to William Kimpton, a London merchant tailor. A connexion between sheep-farming and the London cloth trade is hinted at here.

There are many other small signs that in the Tudor period much London capital was invested in land in Hertfordshire. In lower grades men took holdings which required some capital. In 1438 Richard Huchin, a villein of Bengeo, together with Henry Bargoyne, took from the lord 80½ acres on an eighteen years' lease at a rent of 13s. 4d.⁶¹ On the termination of this lease in 1456 he joined with T. Birch to take the warren for fifty years for 8s. a year.⁶² In 1453 he took another small tenement and another in 1465.⁶³ The partnerships look as though the villeins were combining their capital. These men were farmers in the modern sense, usually lessees, economically superior to the small freeholder or copyholder.

The Elizabethan poor law did not lay a heavy burden on the Hertfordshire ratepayers. There was apparently very little pauperism in the county. The maintenance of tillage was probably giving sufficient occupation. Pauperism was small until the Civil War at least. About the Restoration there are signs of an increase. The overseers of Great Gaddesden complained that they were very hard charged with a numerous poor.⁶⁴ The poor began to petition the justices for increased allowances.⁶⁵ At Hertingfordbury the overseers wished to escape extra charges even by dishonest means. Nevertheless

⁵⁸ Aug. Off. Misc. Bks. cccxci, fol. 18 et seq.

⁵⁹ Ct. R. (Gen. Ser.), portf. 176, no. 121.

⁶¹ Add. MS. 27976, fol. 17 et seq.

⁶⁴ *Sess. R.* (Herts. Co. Rec.), i, 174.

^{58a} Harris Nicolas, *Christ. Hatton*, 43.

⁶⁰ Ld. Rev. Misc. Bks. ccxvi, fol. 1 et seq.

⁶² *Ibid.* ⁶³ *Ibid.*

⁶⁵ *Ibid.* 258.

SOCIAL AND ECONOMIC HISTORY

the parish officers of Great Wymondley could still certify in 1687 that the parish had provided for all its own poor for the last thirty years.⁶⁶ The increase of population inevitably led to increase of pauperism. Complaints of the heavy rate had been made in 1741.⁶⁷ The first record of the cost to the county is the average for three years ending 1750; the sum was £16,452.⁶⁸

By 1776 it increased to £25,241.⁶⁹ After 1782 the rise was more rapid. By 1785 the amount was £35,512.⁷⁰ The rate was highest in the towns and along the great road, where the expense of passing vagrants was heavy. At Chipping Barnet it was 2s. to 2s. 6d. in the pound about 1797.⁷¹ Redbourn showed the effects of the Act. From 1773 to 1777 the rate varied between 1s. 5d. and 1s. 11d. From 1783-9 it was never below 2s. and reached 2s. 3d. in 1791.⁷²

In 1783 the three years' average was £56,380 and in 1815 £88,952, although the population was only 115,400 in 1811.⁷³ The rise went on: £91,164 in 1818, £99,934 in 1821. The actual annual amount spent was highest in 1818, when it was £101,146.⁷⁴ By 1821 it had sunk to £98,000.⁷⁵ Only twelve of the forty counties paid less.⁷⁶ Compared with some districts, the rate was 'not very high,' although it had admittedly increased about one-third within five years.⁷⁷ The officers of St. Albans tried to assess personal property, but this had to be given up. When men were rated who could not pay the justices simply told their officers not to insist.⁷⁸

Some of the rural parishes abandoned the Speenhamland system long before 1834. At Hatfield the rate had been about 6s. to 8s. about 1819. The growth of unemployment was so alarming that in 1819 the workhouse test was rigorously applied. Allowances according to the number of children were forbidden and out-relief was only given in food or necessaries. The saving in the ten years from 1821 over the previous ten years was £14,000. It was no wonder that neighbouring parishes adopted the same regulations, even when they had to build a workhouse, as at Welwyn.⁷⁹

After 1834 the expense dropped to nearly half. In 1842 the total was £53,494 for a population of 176,173.⁸⁰ By 1847-8 there was a rise, perhaps on account of agricultural depression, to £99,583.⁸¹ In the following years the rate sank rapidly; between 1850 and 1851 there was a decrease of 8.6 per cent.,⁸² and these figures meant a decrease in pauperism as well as an increase of economy. The rate was sinking in 1860,⁸³ but in the next decade it rose quickly. The year 1868 had an increase of 8.2 per cent. over 1867, and the expenditure was £116,789.⁸⁴ The increase was maintained up to 1879.⁸⁵

The methods of relief were various. In 1623 the justices provided corn in every parish to be sold at half-price to the poor,⁸⁶ a kind of out-

⁶⁶ *Sess. R. (Herts. Co. Rec.)*, i, 370.

⁶⁸ *Poor Law Rep.* (1822), 24-5.

⁷¹ Sir F. M. Eden, *State of Poor*, ii, 271 et seq.

⁷³ *Poor Law Rep.* (1822), 24-5.

⁷⁷ *Ibid.* (1818), 87 et seq.

⁸⁰ *Accs. and Papers*, 1844 (42), xl, 123.

⁸² *Ibid.* 1851 (1461), xxiii, 84.

⁸⁴ *Ibid.* 1868-9 (4197), xxviii, 60, 246.

⁶⁷ *Ibid.* ii, 78.

⁶⁹ *Ibid.* ⁷⁰ *Ibid.*

⁷² *Ibid.* 275 et seq.

⁷⁵ *Ibid.* 8.

⁷⁶ *Ibid.*

⁷⁹ *Ibid.* (1831), 266-70.

⁸¹ *Ibid.* 1849 (1024), xxv, 36.

⁸³ *Ibid.* 1860 (2675), xxiii, 54-8.

⁸⁵ *Ibid.* 1878-9 (2372), xxviii, 198.

⁸⁶ *Cal. S. P. Dom.* 1619-22, p. 540.

A HISTORY OF HERTFORDSHIRE

relief without the test of destitution. In the parishes of Odsey and Edwinstree Hundreds in 1631 the able-bodied were relieved with corn at reasonable prices, so that they did not lose their day's work to go to market. Out-relief seems generally to have been by bread or money.⁸⁷ The impotent seem mostly to have been relieved in their own homes. This was true of St. Albans in 1632.⁸⁸

At East Barnet in 1639 there was but one pauper, Widow Chambers, to whom the overseer gave 2s. a week. The seven cases at Elstree also received small allowances and so did the poor of Northaw. At Chipping Barnet there seem to have been no paupers.⁸⁹ One reason for this treatment of the impotent was the small number of poor-houses. One had been built at Waltham in 1593⁹⁰ and another in 1639 at Hunsdon.⁹¹ But the rarity of notices of them suggests that Hertfordshire was not well stocked with workhouses until after Gilbert's Act.

An alternative plan used in the 17th century was the boarding out of paupers. Until 1639 the poor at Hunsdon were 'housed in private houses.'⁹² The demand for labour made the treatment of the able-bodied and of the children fairly easy. In parish after parish between 1630 and 1640 the justices report 'our poor are set to work'⁹³; 'our able poor are set to work and our children apprenticed'⁹⁴; 'we have bound 66 apprentices in St. Albans and 136 in the hundred, and are raising parish stocks to set the poor on work'⁹⁵; 'our poor are relieved and all our children at work; our stock remaining is 40s.'⁹⁶; 'there is a stock of £8 for setting the poor to work'⁹⁷; 'we have no poor children to put forth.'⁹⁸

The Poor Law system was on a very small scale. But after the Civil War and in the 18th century conditions changed. The number of deserted families who came on the parish was increasing, in spite of the Act of 1662.⁹⁹ Hertfordshire, however, offered a fair amount of employment to the agricultural labourer. The poor rate was steadily rising. Nevertheless such figures as we have do not seem excessive. At St. Albans in 1797 there were seventeen men and women and twenty-two children in the workhouse and fifteen out-pensioners.¹⁰⁰ At Redbourn there were thirty people in the workhouse and the farmer was allowed to give 'pensions to twenty-two paupers whom he could relieve' more cheaply outside. This seems to indicate more pauperism in the country than in the town. About this time the justices were obliged by the dearness of food to adopt the 17th-century method of out-relief in corn. In 1795 some parishes bought flour and bread for the use of the poor, and parish funds were started.² In 1817, in the agricultural district round Hitchin, those who lived 'on the rates' were better off than the paupers who paid them.³ As Gilbert's Act had abolished the workhouse test, the justices were perplexed to know where their tests of relief began. The idle poor were saved from selling their furniture, but rates were taken by distress.⁴ Poor relief had become a

⁸⁷ S. P. Dom. Chas. I, ccxxxi, 19.

⁸⁸ Ibid.

⁸⁹ Ibid. ccccxviii, 21 (i-ix).

⁹⁰ *Hist. MSS. Com. Rep.* viii, App. i, 432b.

⁹¹ *Sess. R.* (Herts. Co. Rec.), i, 62.

⁹² Ibid. ⁹³ S. P. Dom. Chas. I, ccxxxi, 19.

⁹⁴ Ibid. 20.

⁹⁵ Ibid. clxxxviii, 43.

⁹⁶ *Cal. S. P. Dom.* 1637, pp. 267-9.

⁹⁷ S. P. Dom. Chas. I, ccccxviii, 21 (i).

⁹⁸ Ibid. (v).

⁹⁹ *Sess. R.* (Herts. Co. Rec.), ii, 78.

¹ Ibid. 275 et seq.

¹⁰⁰ Sir F. M. Eden, *State of Poor*, ii, 271.

² *Poor Law Rep.* (1818), 87.

⁴ Ibid. 94.

SOCIAL AND ECONOMIC HISTORY

paradox. The justices had fixed no minimum subsistence rate, so that there was a wide margin for discretion. Possibly this was better than a rate fixed too high, like that in Cambridgeshire, where in consequence wages were 20 per cent. higher than in the adjoining parts of the county of Hertford.⁵

The Poor Law of 1834 caused indoor relief to shrink even faster than outdoor relief. At the end of the Lady Day quarter of 1843 there were 4,334 indoor paupers and 13,735 out.⁶ On 1 July 1851 1,431 paupers were in the workhouses and 9,014 received relief outside.⁷ From this time the figures remain fairly constant until about 1877, when the number shrinks.⁸ In 1878 the indoor paupers were 1,661 and the outdoor 7,114.⁹ Ten years later the outdoor relief had increased slightly in comparison with the indoor; the figures were 1,275 and 7,325.¹⁰ In 1899 there were 1,272 indoor paupers and 6,218 relieved outside the workhouse.¹¹

After Gilbert's Act came into force the burden of the poor rate made economy the one aim of the parishes. Presumably this suggested the farming of the poor, of which we find mention first about 1790. At St. Albans both indoor and outdoor relief was farmed before 1793. In 1774 after a brief space of parish management the farm was £400 a year.¹² The parish provided house and furniture, and the contractor fed and clothed the thirty-nine inmates, relieved the out-pensioners and dealt with the casuals; the farmer lost £100 a year in spite of the paupers' earnings.¹³ At Barnet the poor were farmed for £23 a month.¹⁴ At Redbourn the sum was £25 a month from 1796; but the system had been used earlier. There is no evidence that it was continued after the reform of the Poor Law.

Pauperism in Hertfordshire was small in degree in the 17th century. But from its position the county was certain to suffer from vagrancy, passing in and out of London. Along the great roads the parishes were heavily burdened. The constables of Barnet in 1639 returned that they had 'whippt and past 8 men and 3 women in the last month to Bedford, Stokenchurch, Maidstone and ye Strond.'¹⁵ At Northaw one vagrant was punished in March and one in February.¹⁶

The general increase of vagrancy led to the Act of 1662, which made poor people removable from a parish which they had newly entered within forty days on the warrant of two justices. This must have increased the poor rates of the Hertfordshire parishes and thrown much work on the parish officers. By the end of the 17th century the figures of vagrancy had risen to something more like the modern scale. Seventy or eighty casuals passed through the St. Albans workhouse in a year.¹⁷ The roads were infested not only by the trampers of the county, but by the out-of-works, the casuals and the criminals of London. In 1834 Hoddesdon was 'oppressed with vagrants in a measure scarcely credible owing to the strict

⁵ *Poor Law Rep.* (1818), 22.

⁶ *Accts. and Papers*, 1844 (42), xl, 123.

⁷ *Ibid.* 1852 (1461), xxiii, 39.

⁸ *Ibid.* 1860 (2675), xxvii, 176 et seq.; 1868 (4197), xxviii, 260.

⁹ *Ibid.* 1878-9 (c.), 2372, 296

¹⁰ *Parl. Papers* (1887) (77 A), lxx, 129.

¹¹ *Ibid.* (1899) (100 B), lxxxiii (1), 619.

¹² Sir F. M. Eden, *State of Poor*, ii, 271.

¹³ *Ibid.*

¹⁴ *Ibid.* 274.

¹⁵ S. P. Dom. Chas. I, ccccxviii, 21 (vi).

¹⁶ *Ibid.* (viii).

¹⁷ Sir F. M. Eden, *State of Poor*, ii, 271-4.

A HISTORY OF HERTFORDSHIRE

attention of the London police.' The parish established a night patrol, and paid a special constable in winter and erected a double cage for temporary confinement.¹⁸

The expense of the system set up in 1662 became very heavy after 1782. Parishes used the most economical system—that of contracting for the removal of vagabonds. The proposals for contracts for 1784 have survived. The farmer offered to undertake the parishes of Sawbridgeworth and Bishop's Stortford for £34 a year, to take all vagrants from the Hertford road for £60, and to clear the road from Waltham Cross to Royston for £85 a year. But this last offer must have been risky, as the passes carried in the last six weeks numbered 104.¹⁹

When the Hertfordshire vagrant was 'passed' back to his parish he had to be employed in a house of correction, according to the Elizabethan statute. For the support of these houses or bridewells the different parishes and hundreds united. There was one such at Buntingford,²⁰ and one for Hertford, Braughing and Broadwater Hundreds.²¹ By 1656 this last was in great decay and required repairs to the value of £50.²² This union seems to have been divided about 1693, when £20 was raised within the half-hundred of Hitchin and part of Broadwater Hundred to set up a bridewell.²³ It is probably from this time that there was one house at Hitchin and one at Hertford. As late as 1763 there was no house of correction for the hundred of Dacorum, though one was needed.²⁴

By the end of the 18th century the justices thought it better to send all vagrants to a central county bridewell than to treat them in local establishments. One was in building next the county jail in Hertford in 1790.²⁵ But some of the country justices cannot have agreed to this, as the local houses were maintained in use. In 1807 the bridewell of the hundred of Edwinstree and Odsey was still used.²⁶ In 1833 a committee reported to the quarter sessions that the bridewells at Buntingford, Great Berkhamstead and Hitchin should be abandoned²⁷ as expensive and inefficient, but no action can have followed, for in 1836 the justices declared that the Berkhamstead house was of the greatest service.²⁸ The opinion of the committee of 1833 that vagrants could be better dealt with at the county bridewells finally prevailed. In 1843 the old houses at Buntingford, Hitchin and Berkhamstead were disposed of.²⁹

The employment of the workhouse and of the bridewell inmates was usually the same. The earliest information about it comes from St. Albans in 1618. One Stephen Langley, a clothier, made proposals to teach the poor to manufacture 'curious woolwork and excellent yarns.'³⁰ Even earlier a scheme was drawn up under which eight towns were to unite to have their poor instructed in cloth-making by a teacher from Hatfield.³¹ In 1630 J. Hockley, a flax-dresser from Ware, who was apparently also keeper of the house of correction, contracted with the borough overseers to teach wool and flax dressing, the spinning of woollen and linen threads and the making of straw hats both to the paupers and to those in the house

¹⁸ *Sess. R. (Herts. Co. Rec.)*, ii, 353.

²¹ *Sess. R. (Herts. Co. Rec.)*, i, 117.

²⁵ *Ibid.* 168.

²⁶ *Ibid.* 214.

³⁰ A. Gibbs, *Hist. Rec. of St. Albans*, 282.

¹⁹ *Ibid.* 153.

²² *Ibid.*

²⁷ *Ibid.* 344.

²⁰ *Cal. S. P. Dom.* 1625-49, p. 585.

²³ *Ibid.* 409.

²⁸ *Ibid.* 363.

²⁴ *Ibid.* ii, 99.

²⁹ *Ibid.* 418.

³¹ *Ibid.*

SOCIAL AND ECONOMIC HISTORY

of correction. The overseers advanced £100 for a stock of flax and wool, but this was to be repaid within seven years.³² Possibly there was a speculative element in the undertaking. Clearly, when the poor were farmed the farmer could only make his profit by their earnings, and their employment in textiles and straw went on into the 19th century. Until 1830 the parish children of Hatfield earned enough for their support at the silk mills of a Mr. Woollam at St. Albans. The parish gave a shed, in which the work was carried on; the children supervised the silk winding and tied the threads when they snapped. The old men were employed on the parish roads, earning 4s. to 4s. 6d. a week. This more than covered their keep, which was reckoned at 3s. 1d. a week, including all expenses.³³ The straw-plaiting was still made by the St. Albans paupers under the farmer in 1797, when they also made mops, but the cloth-work had ceased.

The housing of the poor came under the cognizance of the Privy Council. The commissioners in 1630 ordered the justices to report on the numbers of cottages newly built with a view to limiting the increase, and the returns show that in the district of St. Albans there was practically no building³⁴; yet the want of cottages was great, owing to the working of the Act of 1589³⁵ forbidding the erection of cottages without assigning 4 acres of land to them, which was not repealed until 1775. That some standard of comfort was maintained by public opinion is clear from presentments made at the sessions of houses 'unfit for a Christian to inhabit.' Additional accommodation could be made under the Act of 1589 by agreement between the justices of the peace and the lord of the manor for the erection of habitations for paupers on the waste.³⁶ In 1665, for example, the churchwardens and overseers of Great Gaddesden petitioned the justices for an order for cottage-building, as they 'were exceedingly straitened for the providing of habitations for the poor at exceeding dear rates as inmates with other persons, whence they are frequently removed, and the petitioners much troubled to replace them again.'³⁷ This limitation of cottage-building led to great public dangers, especially in the towns. Overcrowding caused fires³⁸ and the infection of many families with plague or pestilential fevers. This seems to have been realized about the end of the 17th century. The county juries were on the watch for the division of tenements.³⁹

Early in the 19th century building had apparently not kept pace with the population. At Hatfield in 1831 carpenters bought land and put up cottages with no gardens, which let at the 'very high rent' of 2s. to 2s. 6d. a week; but even those who disapproved of this speculative building admitted that without it the poor could not have been housed at all.⁴⁰

The inclosure of arable was unlikely to lead to quarrels, as each man's amount of arable was definite and the advantages obvious. It went on steadily in the 17th century. Large part of the arable at Barnet was inclosed before 1640.⁴¹ This was true at Aldenham and North Mimms.⁴² Round

³² A. Gibbs, *Hist. Rec. of St. Albans*, 282.

³³ *Poor Law Rep.* (1831), 272.

³⁴ S. P. Dom. Chas. I, ccccxviii, 21.

³⁵ Stat. 31 Eliz. cap. 7; 15 Geo. III, cap. 32.

³⁶ Many cottages erected in this way on the roadside waste may still be seen.

³⁷ *Sess. R.* (Herts. Co. Rec.), i, 174. ³⁸ *Ibid.* 347. ³⁹ *Ibid.* ii, 23, 27. ⁴⁰ *Poor Law Rep.* (1831), 273.

⁴¹ Chan. Inq. p.m. (Ser. 2), cclxxxiv, 15; cccix, 189; cccvii, 95; cccliv, 136.

⁴² Ct. of Wards, Feod. Surv. 17; *Cal. S. P. Dom.* 1638-9, p. 274; Chan. Inq. p.m. (Ser. 2), cccclxxxi, 14.

A HISTORY OF HERTFORDSHIRE

St. Albans, too, the common fields were being cut up.⁴³ In this direction round Bushey and Watford the inclosure of the common lands was probably fairly complete by the end of the 17th century. Defoe looked from Bushey Heath across a great parterre of inclosed cornfields.⁴⁴ Higher up the Colne Valley, at Berkhamstead, much of the arable had been lately sold as separate parcels to the tenants.⁴⁵ In the middle belt of the county, at Welwyn and at Sacombe, the arable was in closes.⁴⁶ Even in the north, in the manor of Hoddenhoo (in Therfield), the demesne included closes of 28 acres, 16 acres and 10 acres.⁴⁷ At Ardley the arable was partly inclosed, partly in the common field.⁴⁸ Some inclosures had been made at Puttenham.⁴⁹ The inclosure was sometimes made without the concurrence of the other open-field farmers. Complaints of this are specially common in the last quarter of the 17th century. A yeoman of Benington had inclosed land in the common field, so too in Aston, Welwyn and Hoddesdon,⁵⁰ and a little later in Weston.⁵¹ The slowness of the process, long after the advantages were realized, proves how limited was the economic freedom of the farmer.

The inclosure of meadow and pasture was usually made by parishes instead of plot by plot, as in the case of the arable. The stint on common pastures was constantly being regulated by manorial by-laws, for, as the commons were broken into, the feeding became more valuable.⁵² Lords, even corporations, desired to have the commons apportioned, as being the gainers. In no case has it been noticed that the other commoners were the petitioners, and in very many cases they resisted with violence. In 1637 the Dean and Chapter of St. Paul's inclosed part of Caddington Wood; the commoners destroyed the palings and turned cattle into the sown parts.⁵³ Some of them, however, had accepted the parts allotted. The difficulty may have been that the chapter claimed common in the rest of the wood after the inclosure, which the adjudicators only granted until the expiry of existing leases.⁵⁴ At Aldenham, about 1640, Lord Falkland tried to inclose, and twenty-seven of the tenants bound themselves together to maintain their rights.⁵⁵ Part of the common woods of Tring were inclosed before 1642, but during the Civil War the inclosure was destroyed.⁵⁶ At Great Berkhamstead the demesne was to be farmed for profit. The park of 1,132 acres was leased as two estates and the lord agreed with the commoners that he should inclose 300 acres of the common heath and leave the rest to them.⁵⁷ At Great Berkhamstead and Little Gaddesden the Earl of Bridgewater was continually disputing with the parishioners. In 1654 his plan to sell his wood on common land was opposed by the commoners.⁵⁸ Some common lands at Harpenden were inclosed before 1667⁵⁹; the process was going on in 1728,⁶⁰ and there are still some open fields there.

⁴³ Chan. Inq. p.m. (Ser. 2), cccxvii, 101; cccxvi, 35; ccxcviii, 63; dcccliv, 27; cclxiii, 189.

⁴⁴ Defoe, *Tour through Gr. Britain*, i (Letter iii). ⁴⁵ Aug. Off. Misc. Bks. cclxv, fol. 1.

⁴⁶ Chan. Inq. p.m. (Ser. 2), cccclxxvii, 13; Ct. of Wards. Feod. Surv. 17.

⁴⁷ Add. MS. 36233, fol. 171 et seq., 195.

⁴⁸ Close, 1649, pt. 1, no. 15.

⁴⁹ Chan. Inq. p.m. (Ser. 2), cccxl, 8.

⁵⁰ *Sess. R. (Herts. Co. Rec.)*, i, 309.

⁵¹ *Ibid.* 395.

⁵² e.g. Ct. R. (Gen. Ser.), portf. 189, no. 30.

⁵³ *Cal. S. P. Dom.* 1637, p. 448.

⁵⁴ *Ibid.* 1639, p. 309.

⁵⁵ Doc. in possession of Lord Aldenham.

⁵⁶ Parl. Surv. Herts. no. 29.

⁵⁷ *Ibid.* no. 7.

⁵⁸ *Sess. R. (Herts. Co. Rec.)*, i, 109.

⁵⁹ D. and C. of Westm. Ct. R. of Wheathampstead.

⁶⁰ *Sess. R. (Herts. Co. Rec.)*, ii, 66.

SOCIAL AND ECONOMIC HISTORY

The scientific farmers of the 18th century pleaded against the common fields. In 1795 the twenty-one years' lease of inclosed land was held up by a Herts. farmer as preferable to tenancy in the common fields⁶¹; he pointed to the case of Ashwell, where the farmers sowed clover on the common⁶² field and fenced it off until wheat-sowing time, thus obtaining inclosure in effect. He maintained that inclosures of the waste and common did not decrease the population in Hertfordshire, as they were made for tillage, and said that the commons and waste still open⁶³ were mostly sheep-down skirting Cambridgeshire.⁶⁴ This was not a wide enough estimate. Inclosures proceeded slowly in the first half of the 18th century. Acts were passed for Barnet and Chipping Barnet in 1728 and 1731.⁶⁵ In the second half it was quicker throughout the county. Between 1766 and 1776 Acts were passed for Elstree,⁶⁶ Hexton, Walsworth (Hitchin), Lilley, Offley and Ickleford⁶⁷; for almost twenty years there were no further Acts, but after 1795 they followed one another rapidly. To connect this with the Corn Law of 1791 is hardly fanciful. Kelshall, which was already partly inclosed, Norton, King's Walden, Tring, Weston, Kensworth, Cheshunt and the parishes of St. John's and All Saints in Hertford obtained Acts before 1801. The total area inclosed since 1766 was 20,524 acres.

Between 1802 and 1820 Inclosure Acts were passed for Hinxworth, Cottered, Tring, Offley, Barley, Bushey, Codicote, Welwyn, Knebworth, Pirton, Wymondley, Ippollitts, Braughing, Westmill, Great Hormead and Bishop's Stortford.⁶⁸ In 1826-30 Anstey and in 1830 Standon and Reed were inclosed,⁶⁹ making a total of 8,464 acres inclosed between 1802 and 1845.⁷⁰

For the twenty-five years after the general Hertfordshire Inclosure Act of 1845 inclosures proceeded pretty steadily. Awards were made for Little Gaddesden,⁷¹ Therfield,⁷² Walkern, Bengeo, Sacombe, Stapleford, Great and Little Munden, Buckland, Stevenage,⁷³ Ware and Bengeo,⁷⁴ Watford Field, Hoddesdon, Widford, Aston, Benington, Little Hadham, Ashwell, Little Hormead, Layston,⁷⁵ Northchurch,⁷⁶ Datchworth, Knebworth, Throcking, Albury, Aspenden and Wyddial, an extent of over 11,000 acres. Hitchin was inclosed in 1877 and 1886.⁷⁷ There is still a good deal of uninclosed land in the county, and in the cases of Bygrave, Wallington and Clothall the entire parishes remain uninclosed and the open-field system can there be seen. The importance of these inclosures can hardly be overestimated. Because they were for tillage, they did not injure the labourer as some of the 15th-century inclosures had done. They represented the farthest limits to which tillage could be extended under the stimulus of war prices, an extension which peace could not support.

Between the 17th and the end of the 18th century there was a change in the size of the Hertfordshire holdings. In 1618 there were tenements in Tewin, of which five were of 100 acres and upwards, five of 50 acres and

⁶¹ D. Walker, *Gen. View of Agric. of Herts.*

⁶² *Ibid.*

⁶³ *Ibid.*

⁶⁴ *Ibid.*

⁶⁵ Priv. Act, 2 Geo. II, cap. 19.

⁶⁶ *Ibid.* 16 Geo. III, cap. 28.

⁶⁷ Slater, *Engl. Peasantry and Encl. of Common Fields*, 280-1.

⁶⁸ *Ibid.*; *V.C.H. Herts.* ii, 180, 281.

⁶⁹ Slater, loc. cit.; Com. Pleas Recov. R. Mich. 3 Will. IV, m. 2; 10 Geo. IV, m. 23.

⁷⁰ Slater, loc. cit.

⁷¹ *V.C.H. Herts.* ii, 208.

⁷² Com. Pleas Recov. R. East. 12 Vict. m. 2.

⁷³ Slater, loc. cit.

⁷⁴ *Blue Bk. Incl. Awards*, 63.

⁷⁵ Slater, loc. cit.

⁷⁶ *V.C.H. Herts.* ii, 285.

⁷⁷ *Blue Bk. Incl. Awards*, 64.

A HISTORY OF HERTFORDSHIRE

eight between 20 and 49 acres. In 1738 twenty-nine men held land at Ridge, the largest estate being 68½ acres; of these six farmed on a four-course rotation including clover. The new farmers preferred to have about 100 to 200 acres.⁷⁸ Round Redbourn in 1797 farms ranged from 15 acres to about 300.⁷⁹ But in general less than 100 acres was hardly profitable.

Another change was taking place. This is apparent in a list of freeholders and copyholders with estates worth £10 a year in 1699.⁸⁰ This list shows what a large number of the landowners did not belong to the parishes. At Datchworth there were seventeen estates, only four of which belonged to Datchworth men. At Yardley only six out of fourteen were local men; at St. John's, Hertford, four out of five, the fifth being a Londoner. Indeed, the number of Londoners is a further illustration of the investment of London capital in Herts. The extreme cases are at Buckland, where none of the seven owners belonged to the parish; Ashwell, where six of the twenty-one landholders were the tenants of one man; and Radwell, where 'Mr. Bell owns the whole parish.' The farmer was often a tenant. The landlord let instead of farming. Hence capital in agriculture was partly in the hands of the landlords, who advanced to their tenants, and partly in the hands of the farmers themselves. The need for capital became specially acute after 1795, when poor land was taken into use. At Tyttenhanger in 1800 a large amount of pasture was improved at great expense by the tenant on capital borrowed from the owner, Lord Hardwicke. Round Hatfield improvements were overdone; land was tilled which could only give a profit at famine prices.

Copyhold tenure in Hertfordshire was losing its old incidents, such as heriot and the fine on alienation or letting,⁸¹ and many farms were probably held in this way. The tenants at will were held to be dangerous, as they racked the land.⁸² In 1795 one expert advised landlords to grant their inclosed lands on twenty-one years' leases.⁸³

Rents were not high even at the end of the prosperous 18th century. In rural districts arable was about 12s. an acre. At Redbourn it was 15s., and near St. Albans, where the situation was an advantage, as much as 50s.⁸⁴ Meadow fell in value before 1732 in consequence of the use of artificial grasses.⁸⁵ It was worth £3 at Redbourn in 1797.⁸⁶ Even in the year 1810-11, when agricultural rents in general reached their highest point, they were untouched in North Hertfordshire, and the farmers in this district were solvent, though not rich, after fifteen years of peace. Possibly farming in Hertfordshire was less speculative than in other parts, even after the Corn Law of 1815, as the soil was naturally tillage ground. But speculative farmers were probably more plentiful near London in South Hertfordshire. This is the district where in 1795 many farms were insufficiently stocked with plough teams.⁸⁷

The council and the justices watched over the corn market in the 17th century as carefully as in the 16th. The chief markets were

⁷⁸ D. Walker, *op. cit.*

⁷⁹ Eden, *op. cit.* ii, 275.

⁸⁰ *Sess. R.* (Herts. Co. Rec.), ii, 4 et seq.

⁸¹ e.g. Hitchin Parl. Surv. Herts. no. 22, and Notebook of the manors of the Dean and Chapter of Westminster.

⁸² D. Walker, *op. cit.*

⁸³ *Ibid.*

⁸⁴ Eden, *op. cit.* ii, 271, 275.

⁸⁵ Ellis, *Practical Farmer.*

⁸⁶ Eden, *op. cit.* ii, 275.

⁸⁷ D. Walker, *op. cit.*

SOCIAL AND ECONOMIC HISTORY

Hertford,⁸⁸ St. Albans,⁸⁹ Royston,⁹⁰ Hemel Hempstead⁹¹ and Ware.⁹² The markets were ruled by the justices. In April 1631 'we of St. Albans do continually look that the market be served and that no corn be sold privately in shops.'⁹³ Although the market was very great, there were so many buyers for the provision of London that the price rose daily till the justices frightened the 'chiefest' away, when the price fell to 4*s.* a bushel.⁹⁴ In January 1633 the market was well supplied, but the price was 5*s.* 6*d.* a bushel.⁹⁵ In 1631 the justices of Edwinstree and Odsey made a complaint which seems to show that the London merchant was widening the area within which he bought. 'Our great corn market at Royston is still stored with corn out of Cambridgeshire insomuch that our own farmers are forced to send their corn upward to Hertford market.' The harvest had been so plentiful that the justices wisely said that the less they interfered the more the prices would fall. New wheat was 5*s.* a bushel, old wheat 6*s.* a bushel, in August.⁹⁶ This was about the rate at Redbourn and Tyttenhanger in 1637⁹⁷ and in the district round Hertford and Ware in 1655.⁹⁸ Ten years later at Standon the bushel was worth 4*s.*,⁹⁹ and, indeed, the price remained stable to the end of the century.¹⁰⁰

Besides the fixing of prices, the justices supervised sales through the licensing of dealers. Unlicensed higglers were as plentiful in the 17th century as they had been in the 16th. Sometimes these outside dealers were men interested in other branches of the trade attracted by the profits of the sale, as when a maltman and two mealmen of Watford and Elstree bought up grain in Watford market for resale.¹ Sometimes gentlemen or yeomen bought and sold as badgers of grain.² Nor was much capital necessary for labourers engaged in the trade.³ In very many parishes there was one of these illicit traders, in some, such as Hatfield or King's Langley, three or four.⁴ Unlicensed merchants increased in numbers in spite of the work of the sessions.

Moreover, the justices could not prevent the increase of sales outside the market. A yeoman with a little money would buy up the supply of his village.⁵ The farmer was willing to sell at his barn doors contrary to the statute.⁶ Even a clerk would lie in wait on the roads leading to the great markets and engross 100 quarters of wheat and 200 of barley.⁷ Possibly this was commoner in the south and west of the county than in the poorer north-east, where the justices stated in 1631 that they had no engrossers of corn.⁸ In the last half of the 17th century buyers forestalled the crop before it was cut.⁹

The peculiarity of the trade was the struggle between the London and the local markets, which raised prices in Hertfordshire. But after the time of Elizabeth this difficulty seems to have been mitigated. In the 18th century the country bakers kept the coarser kinds of grain almost entirely ;

⁸⁸ Duchy of Lanc. Dep. 6 Jas. I, no. 60.

⁸⁹ S. P. Dom. Chas. I, clxxxviii, 43.

⁹⁰ Ibid. cxcviii, 39 ; *Hist. MSS. Com. Rep.* xiii, App. xi, 274.

⁹¹ *V.C.H. Herts.* ii, 217-18.

⁹² *Sess. R.* (Herts. Co. Rec.), ii, 24.

⁹³ S. P. Dom. Chas. I, clxxxviii, 43.

⁹⁴ Ibid.

⁹⁵ Ibid. ccxxxi, 19.

⁹⁶ Ibid. cxci, 39.

⁹⁷ *Cal. S. P. Dom.* 1635-7, p. 274.

⁹⁸ *Sess. R.* (Herts. Co. Rec.), i, 109.

⁹⁹ Ibid. 166.

¹⁰⁰ Ibid. 237.

¹ Ibid. 50.

² Ibid. 278, 28 ; ii, 2.

³ Ibid. i, 329 ; ii, 28.

⁴ Ibid. i, 329.

⁵ Ibid. 61.

⁶ Ibid. 315.

⁷ Ibid. 109.

⁸ S. P. Dom. Chas. I, cxcviii, 39.

⁹ *Sess. R.* (Herts. Co. Rec.), i, 140, 144 ; cf. 166 and 171.

A HISTORY OF HERTFORDSHIRE

the fine went to London, but the dealers tried to keep the same prices in both markets. In 1770 the justices of St. Albans even tied the bread prices together. The assize of bread was to be regulated by the London assize, the wheaten peck loaf being 2*d.* less in St. Albans than in London and other loaves in proportion.¹⁰ London was drawing supplies always from more distant counties. Nevertheless this stimulus made the corn trade and corn-growing for the market the employment on which the county depended.

The golden age of the Hertfordshire corn dealer began about 1750. Prices were rising. The quartern wheaten loaf, which was 5½*d.* at St. Albans in 1751, was 7*d.* in 1768 and the household loaf had risen 2*d.*¹¹ in 1772, when wheat was 7*s.* a bushel.¹² When the great rise came in the local buyers were outbid. Scarcity began to approach famine. In September 1795 crowds besieged the bakers' shops at Baldock, demanding that bread should be lower. One baker told them from a window that he could not lower it without consulting the other bakers.¹³ But the remedy did not lie in their hands, for bread could not be cheaper until the London corn market was glutted for some time. The shortage prompted the justices to reduce their household consumption of wheat by one-third until the bushel had come down to 8*s.*¹⁴ They were binding themselves, without knowing it, for twenty years. The allowances to prisoners had to be increased and the misery of the debtors induced the justices to grant them bread at the felons' rate.¹⁵ But year after year prices remained up. In 1801 the quartern loaf was 1*s.* 3½*d.* in October and rose steadily to 1*s.* 8½*d.* in the following January.¹⁶ It sank 1*d.* in February, but reached 1*s.* 10*d.* by the end of March. By the end of May it had come down to 1*s.* 4½*d.*, the price until the end of July.¹⁷ The harvest must have been good, for in 1803, in the Easter quarter, the loaf was but 8½*d.* to 8¾*d.*¹⁸ The next year's prices were also low,¹⁹ 7¾*d.* to 8*d.* in July and 11½*d.* at Michaelmas; afterwards, while they ran up to 1*s.* 4*d.* at Christmas 1805,²⁰ they never dropped below 1*s.* until after the harvest. They hovered about 1*s.* for the rest of 1806²¹ and this cheapness seems to have lasted till the end of 1808. From 1809 to 1812 the rise is perceptible. In June 1813 the loaf was 1*s.* 7¾*d.*²² The quality of the grain was often poor. In 1815 the rent of the tolls of St. Albans market was reduced because of its inferiority²³; but the price of the loaf did not fall. The average price of the bushel from 1799 to 1820 was 10*s.* 2½*d.*²⁴ But the war time and war prices were over and the price of corn came down. In 1830 the average for the country was 7*s.* 6*d.* a bushel.²⁵

The corn trade was flourishing in the 17th century and with it the malt trade with London expanded.

Malting was an ancient occupation, but it now began to be of commercial importance in the whole area of the Lea Valley and up to the borders of Cambridge. The change was accomplished about the end of the 16th century.²⁶

¹⁰ A. E. Gibbs, *Hist. Rec. of St. Albans*, 137. ¹¹ *Ibid.* 126, 136. ¹² *Sess. R.* (Herts. Co. Rec.), ii, 23.

¹³ *Ibid.* 179. ¹⁴ *Ibid.* 183. ¹⁵ *Ibid.* 195, 243. ¹⁶ *Ibid.* 196, 200. ¹⁷ *Ibid.*

¹⁸ *Ibid.* 251. ¹⁹ *Ibid.* 204. ²⁰ *Ibid.* 206-7. ²¹ *Ibid.* 273. ²² *Ibid.* 220, 233-4, 239.

²³ Gibbs, *op. cit.* 166. ²⁴ *Sess. R.* (Herts. Co. Rec.), ii, 259, 281. ²⁵ *Ibid.* 330.

²⁶ cf. W. Harrison, *Descr. of Britain* (1587). 'Our malt is made all the year long in some great towns, but in yeomen's and gentlemen's houses the winter half is thought the best. They make sufficient for their own expense only.'

SOCIAL AND ECONOMIC HISTORY

Between Royston and Ware the great malt-wagons tore up the roads.²⁷ The sessions order that in winter malt must be conveyed on pack-horses was probably ineffective.²⁸ Maltsters were beginning to make for the London consumer. They were growing rich.²⁹ With characteristic dread of a rapid growth of production for distant markets, the council endeavoured to suppress these unnecessary persons. In 1631 the justices of St. Albans and Cashio promised to deal with them at the next sessions.³⁰

The 'restraint of malt making' continued for five years, and in 1637 the harm involved was set forth on behalf of Baldock, Stortford, Hitchin, Ashwell and Royston. 'Most maltsters are employed by gentlemen and others, who send them barleys to be malted for provision for their houses. Also widows and others with some small stock buy barley and hire the malting. These poor maltsters are very useful to the county and pay good rents; but being restrained must turn day labourers, of whom many already want work.'³¹ The effort to repress the trade was probably unsuccessful, for complaints of the malt-wagons were raised throughout the eastern side of the county in 1646. The increase of maltsters in Ware was also pointed out.³²

By the end of the 18th century the maltsters of Stortford had something like a monopoly of the supply to London porter brewers. They received their corn from Cambridgeshire and Essex as well as Hertfordshire.³³ Malting has remained one of the principal trades of the shire. Forty years ago Ware was said to make more malt than any other town.³⁴

In the 17th century the Hertfordshire labourer may have been occasionally a landholder. At Tewin, for instance, in 1618 among the thirty holdings in the parish there were four of 5 acres, which suggests that their owners did not live entirely by farm produce.³⁵ But these landed labourers were an ever-dwindling number. In 1794 the Ashwell cottagers still had the right to put two cows each on the common, but they were mostly too poor to keep one.³⁶ The only way in which they obtained the use of a little land was by such a custom as that of the Hatfield farmers, who used to give their labourers little plots to cultivate.³⁷

The labourers' earnings did not vary much between 1600 and 1700. In 1591 the rates were fixed as follows: mowers received 8*d.* to 12*d.* an acre for wheat or grass, and other halms proportionately down to oats at 5*d.* an acre; raking and cocking was 5*d.* or 4*d.* an acre. Men reaped for 6*d.* a day with food and 10*d.* without, and women for 5*d.* or 8*d.* Threshing was paid by the quarter and varied, according to the grain, from 6*d.* to 12*d.* Day labourers earned 4*d.* a day with food or 8*d.* without from March to September; the winter wages were probably a little less. For a servant hired by the year the highest wage was £2 a year with a livery, or £2 6*s.* without; shepherds 33*s.* 4*d.* with a livery.³⁸ These wages may be compared with those current in 1632. Mowers then had 10*d.* to 14*d.* (a day?); or if paid by the acre, from 2*s.* to 1*s.* for the toughest sorts of grass to 8*d.* for oats.

²⁷ *Cal. S. P. Dom.* 1631-3, pp. 66, 404, 409-10.

²⁸ *Ibid.*

²⁹ *Ibid.* 1636-7, p. 404.

³⁰ *S. P. Dom. Chas. I.* clxxxviii, 43.

³¹ *Cal. S. P. Dom.* 1636-7, pp. 323-4.

³² *Sess. R.* (Herts. Co. Rec.), i, 86; cf. also ii, 24.

³³ *Rep. on Public Breweries* (1819), 9-13.

³⁴ Cussans, *Hist. of Herts.* i, 131.

³⁵ *Add. MS.* 33575, fol. 97.

³⁶ Walker, *op. cit.*

³⁷ *Poor Law Rep.* (1831), 276.

³⁸ *Sess. R.* (Herts. Co. Rec.), i, 8-12.

A HISTORY OF HERTFORDSHIRE

Raking and cocking was *6d.* to *7d.* Reaping corn was worth *8d.* a day with food or *12d.* without. Labourers earned daily in the winter *4d.* or *5d.*³⁹ But this rate seems to have been commonly exceeded.⁴⁰ Thus it will be seen that there was a rise from *1d.* to *2d.* in the pay for most kinds of harvest work since 1591. The prescribed rate of wages for the rest of the year was less changed.

We have a table of wages for the year 1677 which is unfortunately less detailed, but it nevertheless indicates a change in the manner of hiring. It shows that labourers' pay was given by the week or year instead of the former payment by the day. Ploughmen had *5s.* to *6s.* a week and shepherds had *3s. 4d.* a week or $\pounds 3$ *10s.* a year to *4s.* a week or $\pounds 5$ a year, more than double the rate of 1632. Labourers at large had from $\pounds 4$ to $\pounds 5$ a year or from *3½d.* to *5½d.* a day.⁴¹ There is thus a great rise in the yearly wages since 1632. This may mean a rise since the Civil War, or that farm servants even when hired for a year lived out and provided their own food. The last interpretation seems the more probable. During the 18th century wages rose, but the state of the labourers was not as much improved as might be expected. The increased mobility of labour told against them. The ease of travel round London allowed labourers from other counties to come for the harvest, which was the most profitable time for them. At the end of the 18th century these outsiders harvested most of the crops in the south of the county. The pay for the harvest month was two guineas a week with food and lodging,⁴² or if by the piece *5s.* to *7s.* for reaping an acre of wheat, or *8d.* to *1s.* for mowing an acre of oats and barley. A quarter of barley or oats or a load of corn was threshed for *1s.* or *18d.*⁴³ Harvest work was better paid than in 1677, in spite of the increased supply of labour.

The ordinary work of the farm was done chiefly by the farm servants, so that the married labourer living in his cottage was hard pressed for a living. The rise was greater in the yearly wage than in that of the day labourer. Carters and ploughmen had from 6 to 9 guineas, the thresher 6 or 7 guineas. Day labourers employed throughout the year by the same farmer had *7s.* a week and small beer except for the harvest month, when they had *9s.* a week. There was a rise here above the rates of 1677, though not so large as in the other case. Seven shillings was probably about the average rate, for in 1796–7 it was the wage of the roundsmen at Hinxworth and the average at Redbourn.⁴⁴ A good labourer could sometimes get work on an agreement for some weeks at a time for *10s.* or *12s.* a week, but this could not be kept up. The father's earnings could rarely be above *10s.* a week for the winter half-year.⁴⁵ The rest of the family might earn a little. In the 17th century the clothier or draper might still make his rounds to the cottages for yarn. Even in 1795 the cottagers' wives spun 1 lb. of wool at prices from *6d.* to *9d.* according to the quality. But as a source of income the spinning was negligible, as the women rarely spun more than 1 lb. a week in winter.⁴⁶ About 1785 the place of spinning was being taken in the northern part of the county towards Dunstable by straw-plaiting.⁴⁷ This

³⁹ A. E. Gibbs, *op. cit.* 287.

⁴² D. Walker, *op. cit.*

⁴⁴ Eden, *State of Poor*, iii, 342; ii, 275 et seq.

⁴⁶ *Ibid.* iii, 342.

⁴⁰ *Sess. R. (Herts. Co. Rec.)*, i, 233, 130.

⁴³ *Ibid.*

⁴¹ *Ibid.* 292.

⁴⁵ *Ibid.*

⁴⁷ D. Walker, *op. cit.*

SOCIAL AND ECONOMIC HISTORY

manufacture spread from this point and was practised at Hatfield before 1812. At this work the women and children could earn between them as much as the men. Round Hitchin in 1817 the result was that the girls were kept from school and knew nothing but how to plait.⁴⁸ Cobbett saw the straw-plait on sale at Tring in 1829, but commented on the use of Tuscan straw, when, as he said, English straw was as good.^{48a}

The wonder was that these families could live at all. By the end of the 18th century their food supplies were largely drawn from an area outside the county; groceries and other victuals passed through London even when they came from the north, and the prices were higher than in London. The labourers bought their inferior bacon at the little village chandlers' shops, where even bread was dear.⁴⁹ The hardship was so great that parish provision stores were suggested.⁵⁰ At Hinxworth in 1796 pork was 10*d.* a pound and meat 6*d.*, and fully half the family income was spent on bread, flour or oatmeal, and 3*d.* or 6*d.* a week to the baker for heating his oven.⁵¹ At St. Albans the meat prices were much the same and bread 11½*d.* the quartern loaf.⁵² In spite of the appearance of great poverty, some saving was possible. At St. Albans there were two friendly societies with about 100 members altogether before 1797.⁵³ At the same time at Redbourn, a rural district, there were three societies.⁵⁴

The conditions of the labourer's life did not change much during the time of high corn prices, except so far as he felt the scarcity almost more than anyone else. Possibly wages may have risen a little under this pressure, for they tended up to 9*s.* or 10*s.* to 12*s.* a week.⁵⁵ From about 1820 the prices of food began to fall,⁵⁶ and, although the farmers suffered, the labourers' wages remained steady, a fact which implies that it was practically a minimum wage relative to the supply of labour and the cost of living, for labour had been fully employed on all the land taken into cultivation. In 1830 at Hitchin people still believed that unemployment was accidental and due to the farmers' lack of capital. 'There is more than sufficient employment if the farmers had capital enough.'⁵⁷ But at Hatfield, at least, the fall in the price of food more than balanced any contraction of the labour market. Moreover, the women earned 8*s.* to 10*s.* and the children 3*s.* to 5*s.* by their straw-work, which was sold in the open market at St. Albans or to dealers who came round to the cottages.⁵⁸ Often, too, capitalists gave out the plait as piecework, paid on delivery.⁵⁹ In addition the rector and the parish authorities of Hatfield encouraged thrift in every way. A Sunday bank started about 1820 had £100 in the first year, and in 1830 £375 from 142 depositors, of whom 111 were labourers.⁶⁰ Nearly all the inhabitants of the parish were in benefit societies.⁶¹ At Hertford in 1817 even the poorest labourers subscribed to a savings bank.⁶² There was a friendly society at Wheathampstead earlier, in 1812,⁶³ and the now famous Buntingford Society dates from the early part of the century.

⁴⁸ *Poor Law Rep.* (1818), 94.

⁴⁹ Walker, *op. cit.*

⁵² *Ibid.* ii, 271.

⁵⁵ *Poor Law Rep.* (1818), 84; (1831), 276.

⁵⁸ *Ibid.* 278.

⁶⁰ *Poor Law Rep.* (1831), 276-7.

⁶² *Ibid.* (1818), 122.

^{48a} Cobbett, *Rural Rides*, 23 Sept. 1829.

⁵⁰ *Ibid.*

⁵³ *Ibid.*

⁵⁶ *Ibid.*

⁵⁹ *Sess. R.* (Herts. Co. Rec.), ii, 410.

⁶¹ *Ibid.* 278.

⁶³ *Sess. R.* (Herts. Co. Rec.), ii, 234.

⁵¹ Eden, *op. cit.* iii, 342.

⁵⁴ *Ibid.* 275.

⁵⁷ *Ibid.* (1831), 273.

A HISTORY OF HERTFORDSHIRE

About 1830 agricultural unemployment in the southern counties was said to have reached its maximum. But in 1848, in spite of repeal, the increase of population and the increased use of agricultural machinery, the Hertfordshire labourers were in good and steady work.⁶⁴

In 1846 Feargus O'Connor acquired Heronsgate, or Herringsgate, near Chorley Wood, for £2,344 in the interest of the future National Land Company.⁶⁵ After 19 acres of coppice had been grubbed up for arable the whole 103 acres were laid out for agriculture on O'Connor's plan. The thirty-five allotments varied from 2 to 4 acres. Thirty-five cottages were built; at first the 2-acre houses were built with three rooms, the 3-acre houses with four and 4-acre houses with five.⁶⁶ Later all the cottages were built on the same plan; each had a flagged day-room with a bedroom on each side,⁶⁷ a back kitchen, dairy, cowhouse, henhouse and pigsty.⁶⁸ They were well built. The schoolhouse built by the company had 2 acres of ground attached; in addition, the master was paid by the parents.⁶⁹ The cost of these buildings and the clearing and manuring of the ground was about £6,700.⁷⁰

The directors expected to 'reproduce' this sum by the profits of the sales of the allotments, the prices of which would rise through the labour put into the ground by the tenants.⁷¹ In the meantime the tenants were to pay as rent 4 per cent. on the outlay, or £9 10s. 10d. on a 3-acre holding.⁷² But after some had been settled for twelve months the calculations necessary to fix the cottage-rents had not been begun.⁷³ The allotments were to be cultivated by hand labour. Herringsgate, or O'Connorville, was fully settled in about a year. The mistakes of the promoter were at once revealed. The men who came to take up the holdings were small tradesmen, merchants or weavers from the manufacturing towns. They understood the ground as little as their wives understood the henhouse or dairy; they even had to buy bread because they knew not how to bake. After nearly a year's settlement they had made no provision of manure, except in so far as a landowner allowed them to collect rotten leaves in the woods. They put in their potato harvest, saying that they must take their chance. They could not bear an out-of-door life and hired at 12s. a week labourers to whom the farmers paid 8s. to 9s.⁷⁴ The prospect for the poor settlers was rather the workhouse than the idyllic homestead.

This mistake was a gross one, but the next was ironically near the truth. The settlers were engaged to cultivate the land, by spade and fork, for the same crops as farmers of 100 acres. Evidence taken before the committee proved that vegetables were profitable on such holdings. The proximity to London was another argument in favour of what we should call French gardening or intensive culture. But it was madness to put men who were not even labourers into competition with farmers, spade work into competition with the plough in arable farming, handwork into competition with the best machinery.⁷⁵ Moreover, Herringsgate was pasture land.⁷⁶ What the scheme represented in the country-side is shown by the attitude of

⁶⁴ *National Land Co. Rep.* iv, 33.

⁶⁷ *Ibid.* iv, 24.

⁷¹ *Ibid.*

⁶⁸ *Ibid.* iii, 27.

⁷² *Ibid.* iv, 23.

⁷⁵ *Ibid.* iv, 31 et seq.

⁶⁵ *Ibid.* i, 1847-8.

⁶⁹ *Ibid.*

⁷³ *Ibid.* iii, 27.

⁷⁶ *Ibid.*

⁶⁶ *Ibid.* ii, 42.

⁷⁰ *Ibid.*

⁷⁴ *Ibid.*

SOCIAL AND ECONOMIC HISTORY

the labourers. They would have liked, they said, to try to make a living on the holdings if they were able to plough.⁷⁷ The cottages were exactly what was needed in Hertfordshire.⁷⁸ If the scheme had been planned for the agricultural labourer, with greater experience of farming, it might have been prosperous and beneficial. It represented, however, 'the townsman's dream of country life.'

In the crafts wages seem to have remained fairly steady over a long period.

The rating of the justices in 1591-2 puts the carpenters, masons, joiners, plasterers, wheel and plough wrights, bricklayers and tilers into one class. From March to September masters or the best journeymen took 8*d.* a day and their meals, or 12*d.* in all. The scale for the worst workmen was 4*d.* or 8*d.* For the winter the highest rate was 6*d.* with food or 11*d.* a day, and the lowest 3*d.* or 7*d.*⁷⁹ Tailors and shoemakers' journeymen, hired by the year, received from 30*s.* to 53*s.*⁸⁰

These wages are lower than those fixed at St. Albans in 1632. Artificers of the best sort took 1*s.* a day and food or 1*s.* 4*d.*, those of the worst sort 5*d.* with food or 10*d.*⁸¹ The 1*s.* a day was paid to labourers some twenty-five years later.⁸²

In 1677 the crafts are grouped rather differently. Carpenters and bricklayers were getting the highest wages, ranging from 1*s.* 10*d.* to 1*s.* a day; tailors and 'all artificers' received 8*d.* and food or 1*s.* 2*d.*⁸³ In 1682 builders and carpenters were earning 1*s.* or 1*s.* 2*d.* a day.⁸⁴ The rise in the hundred years is not great. Apparently the wage was a sufficient one until the rise in the price of food about 1790. It is not until this time that labour troubles appear. But then several cases suggest that even in Hertfordshire industrial labourers grasped at the idea of combination. In 1790 eleven journeymen paper-makers employed by one Vallance at his mill in Bishop's Hatfield joined to compel him to raise their wages 1*s.* a week. They threatened to leave if he would not do so.⁸⁵ In 1796 some labourers at Ware struck work. They tried to force four barge-masters and maltsters, their employers, to raise their wages, and attempted to frighten the black-legs away.⁸⁶ In such cases the labourers must always have lost, as the 'conspiring' was an indictable offence.

From the end of the 17th century labourers and yeomen and artificers were gradually being drawn into retail trading. Men of the most diverse callings 'practised the mystery of a grocer without apprenticeship. The grocer is the commonest case.'⁸⁷ Higglers of dead victual were also becoming very numerous.⁸⁸ This growth of retail trade corresponds in time with the development of the corn and malt trades, of which it was probably the effect.

The same period shows signs of capitalism among the workmen. The evidence is clearest as to carpenters. In 1663 two carpenters and four masons estimated for the repair of Welwyn steeple. 'They undertook the carpenters'

⁷⁷ *National Land Co. Rep.* iv, 31 et seq.

⁷⁹ *Sess. R. (Herts. Co. Rec.)*, i, 8-12.

⁸¹ Gibbs, *Hist. Rec. of St. Albans*, 281.

⁸³ *Ibid.* 292.

⁸⁴ *Ibid.* 339.

⁸⁶ *Ibid.* 182; cf. also 249 and 277.

⁸⁷ *Ibid.* i, 45, 155, 183, 244, 254, 329.

⁷⁸ See above.

⁸⁰ *Ibid.*

⁸² *Sess. R. (Herts. Co. Rec.)*, i, 130.

⁸⁵ *Ibid.* ii, 167.

⁸⁸ *Ibid.* 62, 230, 350, 368; cf. 373.

A HISTORY OF HERTFORDSHIRE

and masons' work, the water carriage and the casting of bells.⁸⁹ In 1682 a single carpenter paid the carpenters and masons and supplied the materials.⁹⁰ At Ayot St. Lawrence in 1772 a 'workman and artificer' estimated for the work of carpenters, plumbers, glaziers, blacksmiths and painters.⁹¹

Modern Hertfordshire has accepted much from the past. The shire is still mainly agricultural. Much land is let in arable farms averaging about 250 acres. Fifteen years ago the acreage under wheat and corn was shrinking, but the cultivation of oats was increasing.⁹² Easy transport to the London markets protected the Hertfordshire farmer to some extent; but the fall in the price of grain has not been balanced by decreased cost of production. Declining profits have enforced considerable reductions of agricultural rents.⁹³

Nevertheless, in 1908 50,661 acres were under wheat, 21,381 under barley and 39,316 under oats.⁹⁴

The innovations in agriculture have taken place in the south and along the railways. Dairy farms have been begun, but the want of pasture can only be overcome by growing the feed on the arable.⁹⁵ Poultry and pigs and vegetables are also raised for the London market.

Agricultural labour is said to be fairly plentiful and good, but it bears a smaller ratio to the population than it must have done formerly. In 1861 the agriculturists were only 25 per cent. of the whole.⁹⁶

In 1895 wages in the northern part of the shire were 12s. a week and had been as high as 14s.⁹⁷ In the next few years the winter wages rose about 1s. to 13s. The summer wages rose by about as much; they varied from 11s. round Royston to 15s. round Watford.⁹⁸

The Hertfordshire towns have grown but very little in size in the last forty years. The population of Hertford has increased by 2,153 persons only.⁹⁹ Hitchin has now 10,072 inhabitants, Barnet and Bishop's Stortford a little above 7,000. Hemel Hempstead, on the other hand, has over 11,000, and St. Albans has more than doubled the 8,200 inhabitants of 1871.¹⁰⁰

London is affecting Berkhamstead, St. Albans, Bushey, Watford and the Lea Valley, and will probably do so more and more. It is in these regions that the population is increasing most rapidly. But the garden city, in the extreme north, shows how long the arm of London is. Planned for those who work in town, Letchworth is an interesting antithesis to Heringsgate.

Hertfordshire has developed in one new direction. The comparative cheapness of land and the ease of transport have fostered various new industries. There are many factories in the southern part of the shire. It may be with these that the future of the county will lie.

⁸⁹ *Sess. R. (Herts. Co. Rec.)*, i, 159; cf. 264.

⁹² *Parl. Papers* (1895), C. 7691, xvi, 79.

⁹⁵ *Parl. Papers* (1895), C. 7691, xvi, 79.

⁹⁷ *Parl. Papers* (1895), C. 7691, xvi, 79.

⁹⁹ *Parl. Papers* (1878-9), C. 2372, xxviii, 409.

⁹⁰ *Ibid.* 339.

⁹¹ *Ibid.* ii, 125.

⁹³ *Ibid.*

⁹⁴ *Accts. and Papers* (1908), cxxi, 130-1

⁹⁶ *Accts. and Papers* (1868-9) (4197), xxviii, 245.

⁹⁸ *Accts. and Papers* (1899), xci, 127.

¹⁰⁰ *Ibid.*

SOCIAL AND ECONOMIC HISTORY

TABLE OF POPULATION, 1801 TO 1901

Introductory Notes

AREA

The county taken in this table is that existing subsequently to 7 & 8 Vict., chap. 61 (1844). By this Act detached parts of counties, which had already for parliamentary purposes been amalgamated with the county by which they were surrounded or with which the detached part had the longest common boundary (2 & 3 Will. IV, chap. 64—1832), were annexed to the same county for all purposes; some exceptions were, however, permitted.

By the same Act (7 & 8 Vict., chap. 61) the detached parts of counties, transferred to other counties, were also annexed to the hundred, ward, wapentake, &c., by which they were wholly or mostly surrounded, or to which they next adjoined, in the counties to which they were transferred. The hundreds, &c., in this table also are given as existing subsequently to this Act.

As is well known, the famous statute of Queen Elizabeth for the relief of the poor took the then-existing ecclesiastical parish as the unit for Poor Law relief. This continued for some centuries with but few modifications; notably by an Act passed in the thirteenth year of the reign of Charles II which permitted townships and villages to maintain their own poor. This permission was necessary owing to the large size of some of the parishes, especially in the north of England.

In 1801 the parish for rating purposes (now known as the civil parish, i.e. 'an area for which a separate poor rate is or can be made, or for which a separate overseer is or can be appointed') was in most cases co-extensive with the ecclesiastical parish of the same name; but already there were numerous townships and villages rated separately for the relief of the poor, and also there were many places scattered up and down the country, known as extra-parochial places, which paid no rates at all. Further, many parishes had detached parts entirely surrounded by another parish or parishes.

Parliament first turned its attention to extra-parochial places, and by an Act (20 Vict., chap. 19—1857) it was laid down (*a*) that all extra-parochial places entered separately in the 1851 census returns are to be deemed civil parishes, (*b*) that in any other place being, or being reputed to be, extra-parochial, overseers of the poor may be appointed, and (*c*) that where, however, owners and occupiers of two-thirds in value of the land of any such place desire its annexation to an adjoining civil parish, it may be so added with the consent of the said parish. This Act was not found entirely to fulfil its object, so by a further Act (31 & 32 Vict., chap. 122—1868) it was enacted that every such place remaining on 25 December 1868 should be added to the parish with which it had the longest common boundary.

The next thing to be dealt with was the question of detached parts of civil parishes, which was done by the Divided Parishes Acts of 1876, 1879, and 1882. The last, which amended the one of 1876, provides that every detached part of an entirely extra-metropolitan parish which is entirely surrounded by another parish becomes transferred to this latter for civil purposes, or if the population exceeds 300 persons it may be made a separate parish. These Acts also gave power to add detached parts surrounded by more than one parish to one or more of the surrounding parishes, and also to amalgamate entire parishes with one or more parishes. Under the 1879 Act it was not necessary for the area dealt with to be entirely detached. These Acts also declared that every part added to a parish in another county becomes part of that county.

Then came the Local Government Act, 1888, which permits the alteration of civil parish boundaries and the amalgamation of civil parishes by Local Government Board orders. It also created the administrative counties. The Local Government Act of 1894 enacts that where a civil parish is partly in a rural district and partly in an urban district each part shall become a separate civil parish; and also that where a civil parish is situated in more than one urban district each part shall become a separate civil parish, unless the county council otherwise direct.

Meanwhile, the ecclesiastical parishes had been altered and new ones created under entirely different Acts, which cannot be entered into here, as the table treats of the ancient parishes in their civil aspect.

POPULATION

The first census of England was taken in 1801, and was very little more than a counting of the population in each parish (or place), excluding all persons, such as soldiers, sailors, &c., who formed no part of its ordinary population. It was the *de facto* population (i.e. the population actually resident at a particular time) and not the *de jure* (i.e. the population really belonging to any particular place at a particular time). This principle has been sustained throughout the censuses.

A HISTORY OF HERTFORDSHIRE

The Army at home (including militia), the men of the Royal Navy ashore, and the registered seamen ashore, were not included in the population of the places where they happened to be, at the time of the census, until 1841. The men of the Royal Navy and other persons on board vessels (naval or mercantile) in home ports were first included in the population of those places in 1851. Others temporarily present, such as gipsies, persons in barges, &c., were included in 1841, and perhaps earlier.

GENERAL

Up to and including 1831 the returns were mainly made by the overseers of the poor, and more than one day was allowed for the enumeration, but the 1841-1901 returns were made under the superintendence of the registration officers and the enumeration was to be completed in one day. The Householder's Schedule was first used in 1841. The exact dates of the censuses are as follows :—

10 March 1801	30 May 1831	8 April 1861	6 April 1891
27 May 1811	7 June 1841	3 April 1871	1 April 1901
28 May 1821	31 March 1851	4 April 1881	

NOTES EXPLANATORY OF THE TABLE

This table gives the population of the ancient county and arranges the parishes, &c., under the hundred or other subdivision to which they belong, but there is no doubt that the constitution of hundreds, parishes, &c., was in some cases doubtful.

In the main the table follows the arrangement in the 1841 census volume.

The table gives the population and area of each parish, &c., as it existed in 1801, as far as possible.

The areas are those supplied by the Ordnance Survey Department, except in the case of those marked 'e,' which were calculated by other authorities. The area includes inland water (if any), but not tidal water or foreshore.

† after the name of a civil parish indicates that the parish was affected by the operation of the Divided Parishes Acts, but the Registrar-General failed to obtain particulars of every such change. The changes which escaped notification were, however, probably small in area and with little, if any, population. Considerable difficulty was experienced both in 1891 and 1901 in tracing the results of changes effected in civil parishes under the provisions of these Acts; by the Registrar-General's courtesy, however, reference has been permitted to certain records of formerly detached parts of parishes, which has made it possible approximately to ascertain the population in 1901 of parishes as constituted prior to such alterations, though the figures in many instances must be regarded as partly estimates.

* after the name of a parish (or place) indicates that such parish (or place) contains a union workhouse which was in use in (or before) 1851 and was still in use in 1901.

‡ after the name of a parish (or place) indicates that the ecclesiastical parish of the same name at the 1901 census was co-extensive with such parish (or place).

§ after the name of a parish (or place) indicates that the civil parish of the same name at the 1901 census was co-extensive with such parish (or place).

o in the table indicates that there is no population on the area in question.

— in the table indicates that no population can be ascertained.

The word 'chapelry' seems often to have been used as an equivalent for 'township' in 1841, which census volume has been adopted as the standard for names and descriptions of areas.

The figures in italics in the table relate to the area and population of such subdivisions of ancient parishes as chapelries, townships, and hamlets.

SOCIAL AND ECONOMIC HISTORY

TABLE OF POPULATION 1801—1901

—	Acre- age	1801	1811	1821	1831	1841	1851	1861	1871	1881	1891	1901
Ancient (or Geographical) County ¹	405,141	97,393	108,428	129,222	142,844	156,660	167,298	173,280	192,226	203,069	220,074	250,080

PARISH	Acre- age	1801	1811	1821	1831	1841	1851	1861	1871	1881	1891	1901
<i>Braughing Hundred</i>												
Bishop's Stortford * † §	3,285	2,305	2,630	3,358	3,958	4,681	5,280	5,390	6,250	6,704	6,595	7,143
Braughing † §	4,368	972	1,029	1,228	1,266	1,358	1,246	1,180	1,076	1,022	974	930
Eastwick † † §	822	153	176	212	169	173	170	116	104	95	71	86
Gilston † §	985	186	197	213	233	246	263	270	270	272	260	281
Hunsdon † †	1,975	569	512	584	592	430	481	516	518	526	532	498
Sawbridgeworth	6,639	1,687	1,827	2,071	2,231	2,394	2,571	2,701	2,832	3,049	3,025	2,846
Standon † §	7,745	1,846	1,889	2,135	2,272	2,299	2,462	2,245	2,259	2,069	2,153	2,240
Stanstead Abbots * † †	2,628	861	832	950	966	1,017	914	980	1,057	1,219	1,322	1,484
Thorley † §	1,536	269	307	386	414	396	402	388	423	415	546	538
Thundridge † §	2,206	437	517	529	588	535	572	489	455	467	450	396
Ware * † §	4,705	2,950	3,369	3,844	4,214	4,653	5,088	5,397	5,403	5,745	5,686	6,097
Westmill †	2,207	328	365	415	418	425	380	353	337	361	302	355
Widford † §	1,168	361	427	461	506	539	519	456	450	511	461	418
<i>Broadwater Hundred</i>												
Aston † †	2,073	416	403	509	494	556	626	639	662	571	541	543
Ayot St. Lawrence † §	751	115	149	160	134	134	147	122	151	112	137	99
Ayot St. Peter † §	1,093	168	176	233	271	240	282	234	232	219	215	221
Baldock †	200	1,283	1,438	1,550	1,704	1,807	1,920	1,974	2,036	1,901	1,918	1,798
Benington † †	2,949	487	529	658	631	605	676	637	581	578	617	515
Datchworth † †	1,960	410	447	494	593	581	648	635	606	626	672	650
Digswell † †	1,656	178	187	204	196	187	239	243	255	227	240	242
Graveley † §	1,838	260	276	316	331	403	412	422	443	380	406	409
Hatfield Bishop's * §	12,884	2,442	2,677	3,215	3,593	3,646	3,862	3,871	3,998	4,059	4,330	4,754
Knebworth † †	2,737	225	182	266	259	253	290	250	245	250	382	548
Letchworth † §	1,131	67	70	76	76	108	76	68	95	108	79	96
Munden, Great † †	3,402	396	457	515	550	477	554	457	447	439	439	310
Munden, Little † †	2,247	453	430	464	521	612	628	601	581	468	415	372
Sacombe † §	1,534	255	308	341	360	325	313	314	304	260	250	210
Stevenage † §	4,545	1,254	1,302	1,664	1,859	1,725	2,118	2,352	2,909	3,116	3,309	3,957
Totteridge † §	1,604	280	368	490	595	469	595	573	474	657	785	844
Walkern † §	2,992	501	554	631	771	718	738	823	799	843	849	788
Watton at Stone † †	3,579	602	644	812	830	920	976	864	866	809	817	710
Welwyn * † †	3,081	1,015	1,130	1,287	1,369	1,395	1,557	1,612	1,634	1,742	1,754	1,703
Weston † †	4,530 ^a	729	708	927	1,046	1,123	1,186	1,196	1,123	969	876	841
Willian † †	1,854 ^a	176	198	269	313	291	322	281	344	299	231	257
Wymondley, Great §	1,491	200	212	329	321	263	335	314	276	270	255	279
Wymondley, Little † §	1,007	169	188	227	226	288	300	318	356	401	411	337

¹ *Ancient County*.—The county as defined by the Act, 7 & 8 Vict. chap. 61, which affected Hertfordshire to the following extent, viz. the Hamlet of Coleshill (Amersham Ancient Parish) was transferred to Buckinghamshire. There were also one or two other small changes under the Act; the parts so transferred had, however, previously been treated as belonging to the County to which they were now legally added.

The population in 1811 is exclusive of 2,797 Militia, who could not be distributed to the places to which they belonged, and in 1821 is exclusive of 509 Militia. (See also note to Royston.)

² *Bishop's Stortford Parish*.—The increase of population in 1871 is chiefly attributed to the temporary presence of a large number of workmen engaged on sewerage works.

³ *Stanstead Abbots Parish*.—The increase of population in 1841 was almost entirely due to the fair being in progress at the time of the Census.

A HISTORY OF HERTFORDSHIRE

TABLE OF POPULATION, 1801—1901 (*continued*)

PARISH	Acce- rage	1801	1811	1821	1831	1841	1851	1861	1871	1881	1891	1901
<i>Cashio Hundred, or Liberty of St. Albans</i>												
Abbots Langley §	5,281	1,205	1,331	1,733	1,980	2,115	2,384	2,400	2,638	2,989	3,230	3,342
Aldenham † §	6,114	1,103	1,127	1,399	1,494	1,662	1,656	1,769	1,929	1,833	2,085	2,177
Barnet, Chipping § *	1,489	1,258	1,579	1,755	2,369	2,485	2,380	2,989	3,375	4,283	4,563	5,190
Barnet, East §	1,697	353	406	507	547	598	663	851	2,925	3,992	5,128	6,839
Braintfield, or Bramfield † §	1,609	192	214	232	204	201	210	191	230	249	213	188
Codicote † §	2,531	584	655	795	805	906	1,039	1,227	1,214	1,191	1,123	1,145
Elstree §	1,510	286	292	309	341	360	396	402	525	662	805	1,323
Hexton † §	1,485	239	314	338	294	295	278	234	241	200	167	155
Newnham † §	975	72	79	112	157	161	150	135	113	113	125	116
Northaw, or Northhall † §	3,305	440	465	566	600	609	545	551	559	583	582	664
Norton † †	1,780 ^o	248	264	313	364	403	399	352	400	331	282	213
Redbourn † §	1,510	1,153	1,333	1,784	2,047	2,024	2,085	2,043	2,162	2,177	2,016	1,932
Rickmansworth	10,021	2,975	3,230	3,940	4,574	5,026	4,851	4,873	5,337	5,511	6,974	8,232
Ridge ^o §	3,615	266	311	390	347	409	366	437	448	406	459	478
St. Albans, St. Michael (part of) † *	6,558	807	840	917	1,010	859	1,157	1,050	901	2,256	2,437	3,088
St. Albans, St. Stephen †	8,140 ^o	1,266	1,394	1,580	1,746	1,826	1,802	1,786	1,979	1,980	2,196	2,085
St. Paul's Walden † §	3,720	758	767	906	1,058	1,113	1,175	1,123	1,154	1,020	946	929
Sandridge †	5,753	581	649	823	810	851	864	833	820	841	1,458	2,250
Sarratt † §	1,540	334	378	397	452	542	613	736	654	700	704	630
Shephall † §	1,156	120	131	187	217	265	242	243	216	221	206	194
Watford § *	10,777	3,530	3,976	4,713	5,293	5,989	6,546	7,418	12,071	15,507	20,269	32,559
<i>Dacorum Hundred</i>												
Aldbury † †	2,058	457	566	676	695	790	820	848	854	912	894	812
Berkhampstead, Great *	4,363	1,690	1,963	2,310	2,369	2,979	3,395	3,585	3,940	4,485	5,073	5,600
Berkhampstead, St. Mary, or Northchurch † §	3,908	735	864	1,028	1,156	1,265	1,383	1,638	1,886	2,135	2,312	2,455
Bushey	3,219	856	1,264	1,507	1,586	2,675	2,750	3,159	4,543	4,788	5,652	6,686
Caddington (part of) §	2,996	754	896	1,170	1,177	1,294	1,299	1,259	1,162	1,146	1,055	1,017
Flamstead	6,004	1,018	1,205	1,392	1,462	1,492	1,852	1,919	2,005	1,846	1,701	1,666
Gaddesden, Great † §	4,149	794	941	1,096	988	1,109	1,161	1,147	1,106	938	871	746
Gaddesden, Little † †	925	388	506	531	492	454	374	386	383	373	312	326
Harpenden †	5,112	1,112	1,386	1,693	1,972	1,872	1,980	2,164	2,608	3,064	3,916	5,067
Hemel Hempstead	12,061	3,680	4,222	5,193	6,037	7,268	8,508	9,347	10,100	10,358	10,915	12,490
Hemel Hempstead *	7,184	2,722	3,240	3,962	4,759	5,901	7,073	7,948	8,720	9,064	9,678	11,264
Bovingdon Chapelry † §	3,958	779	794	954	962	1,072	1,130	1,155	1,162	1,054	1,056	1,047
Flauden Chapelry §	919	179	188	277	316	295	305	244	218	240	181	179
Kensworth † §	2,553	510	522	615	732	842	1,033	925	891	655	605	516
Kings Langley §	3,481	970	1,108	1,242	1,423	1,629	1,599	1,509	1,495	1,464	1,629	1,579
North Mimms §	4,966	838	1,001	1,007	1,068	1,118	1,128	1,095	1,157	1,266	1,511	1,568
Puttenham † †	744	130	153	112	130	136	142	135	123	121	105	97
Shenley §	4,091	729	990	1,132	1,167	1,220	1,297	1,304	1,380	1,321	1,425	1,509
Studham (part of) † ^o	1,449	205	220	238	231	237	231	219	198	173	128	125
Tring †	7,846	2,156	2,557	3,286	3,488	4,260	4,746	4,841	5,076	5,357	5,424	5,054
Wheat-hampstead † §	5,187	1,043	1,250	1,584	1,666	1,871	1,908	1,960	2,188	2,319	2,371	2,405
Wigginton † §	1,674	330	373	477	536	635	643	641	661	709	707	669

⁴ Aldenham Parish is partly in Dacorum Hundred; none shown there.

⁵ Chipping Barnet Parish.—The population included in 1841 226 strangers haymaking, and in 1861 118 persons attending a fair.

⁶ Ridge Parish.—The population in 1841 included a number of haymakers temporarily present.

⁷ St. Albans, St. Michael Parish is situated partly in Cashio Hundred and partly in the Borough of St. Albans. The entire area and population, 1881–1901, are shown in Cashio Hundred.

⁸ Watford Parish.—The increase of population in 1871 was due largely to the opening since 1861 of the Leavesden Asylum and the St. Pancras Industrial Schools.

⁹ Caddington Parish.—The remainder is in Bedfordshire (Flitt Hundred).

¹⁰ Studham Parish.—The remainder is in Bedfordshire (Manshead Hundred).

SOCIAL AND ECONOMIC HISTORY

TABLE OF POPULATION, 1801—1901 (*continued*)

PARISH	Acreage	1801	1811	1821	1831	1841	1851	1861	1871	1881	1891	1901
<i>Edwinstree</i>												
<i>Hundred</i>												
Albury † §	3,248	557	519	596	631	641	668	700	673	621	563	505
Anstey † §	2,150	387	371	440	417	497	465	473	412	391	396	364
Aspenden † †	1,407	364	367	455	550	529	508	577	667	613	485	480
Barkway —	5,211	851	858	993	1,108	1,291	1,288	1,221	1,188	999	968	829
Barkway §	3,252	699	686	771	859	1,002	986	940	934	782	761	661
Nuthampstead Hamlet §	1,959	152	172	222	249	289	302	281	254	217	207	168
Barley † §	2,725	494	593	695	704	792	870	809	714	615	574	505
Buckland §	1,629	300	288	343	373	435	386	385	362	358	376	244
Hadham, Little † §	3,082	685	670	787	878	890	878	864	869	853	733	655
Hadham, Much † §	4,490	980	1,081	1,208	1,268	1,318	1,264	1,172	1,318	1,298	1,274	1,199
Hormead, Great †	1,919	467	513	564	576	595	601	660	631	519	436	376
Hormead, Little †	1,067	103	94	112	107	121	87	103	143	127	116	128
Layston * † †	2,242	799	907	1,014	1,093	1,187	1,220	998	1,086	1,071	1,091	983
Meesden † §	1,009	122	138	164	158	181	185	163	181	189	178	132
Pelham, Brent §	1,637	208	242	280	271	285	298	286	284	232	215	207
Pelham, Furneux §	2,585	529	533	566	619	682	688	620	618	571	540	449
Pelham, Stocking † §	647	109	122	150	158	160	138	126	185	173	144	138
Throcking † †	910	58	45	69	76	66	85	97	63	74	70	50
Wakeley Extra	463	7	8	9	7	7	9	4	4	10	46	24
Parochial ¹¹ †												
Wyddial † †	1,224	181	175	225	243	248	245	213	199	202	241	221
<i>Hertford</i>												
<i>Hundred</i>												
Amwell, Great †	2,482	772	1,003	1,110	1,321	1,545	1,652	1,660	2,245	2,517	2,612	2,954
Bayford † †	1,745	235	224	307	332	357	353	297	352	273	349	330
Bengeo ¹²	3,054	584	536	731	855	1,141	1,520	1,791	2,044	2,335	2,586	2,726
Berkhampstead, Little † †	1,694	314	305	439	450	555	556	450	408	424	430	420
Broxbourne and Hoddesdon †	4,535	1,598	1,668	1,888	2,144	2,386	2,571	2,663	2,872	3,466	4,192	4,810
Cheshunt §	8,479	3,173	3,598	4,376	5,021	5,402	5,579	6,592	7,518	7,735	9,620	12,292
Essendon † §	2,331	545	566	595	672	690	739	672	645	594	540	565
Hertford, All Saints (part of) ¹³	2,060	866	695	903	1,133	1,218	1,208	1,341	1,361	1,638	1,868	2,062
Amwell, Little Liberty †	526	403	243	256	368	461	458	500	618	704	861	853
Brickendon Liberty ¹⁴	1,534	463	452	647	765	757	750	841	743	934	1,007	1,209
Hertingford-bury † §	2,645	625	653	827	753	737	752	799	828	823	797	733
Stanstead St. Margarets † §	408	65	85	97	107	92	97	93	107	96	139	192
Stapleford † §	1,355	111	131	212	237	259	289	226	249	200	216	216
Tewin † §	2,695	494	438	477	474	522	522	547	513	530	550	492
Wormley † §	946	445	433	492	471	500	511	572	692	735	871	1,018
<i>Hitchin and Pirton</i>												
<i>Hundred</i>												
Hitchin *	6,420	3,161	3,608	4,486	5,211	6,125	7,077	7,677	8,850	9,070	9,510	10,788
Ickleford †	1,035	337	351	442	502	570	574	546	589	563	529	577
Ippollitts §	2,936	464	541	671	874	919	965	952	994	1,008	894	840
Kimpton † §	3,677	644	746	866	944	945	992	1,014	952	936	991	944
King's Walden † §	4,392	727	779	926	1,004	1,034	1,164	1,183	1,156	1,135	1,124	1,026
Lilley †	1,849	315	395	427	451	475	528	480	520	505	526	438
Offley †	5,515	602	754	873	967	1,140	1,208	1,215	1,346	1,302	1,268	1,066
Pirton † †	2,761	481	558	630	758	764	897	1,023	1,081	1,125	1,016	900

¹¹ Wakeley seems to have been anciently a Parish.

¹² Bengeo Parish is partly in Hertford Borough; none shown there.

¹³ Hertford, All Saints Parish is partly in Hertford Hundred and partly in Hertford Borough.

¹⁴ Brickendon Liberty is partly in Hertford Borough; none shown there.

A HISTORY OF HERTFORDSHIRE

TABLE OF POPULATION, 1801—1901 (*continued*)

PARISH	Acre- age	1801	1811	1821	1831	1841	1851	1861	1871	1881	1891	1901
<i>Odsey Hundred</i>												
Ashwell † § . . .	4,109	715	754	915	1,072	1,235	1,425	1,507	1,576	1,568	1,556	1,281
Broadfield § . . .	375	31	26	23	10	6	8	19	26	19	16	7
Bygrave † . . .	1,809 ^e	52	61	107	145	154	221	195	191	239	195	202
Caldecote † § . . .	326	44	40	46	39	41	49	44	36	31	31	25
Clothall † † . . .	3,444 ^e	184	216	358	444	495	535	492	486	417	402	335
Cottered § . . .	1,832	339	343	410	436	465	437	470	456	379	357	339
Hinxworth † § . . .	1,463	228	243	247	295	328	347	320	313	297	289	230
Kelshall † § . . .	2,360	179	180	208	251	276	326	318	286	249	241	217
Radwell † § . . .	743	58	72	91	103	98	88	102	103	101	101	90
Reed § . . .	1,477	164	158	214	232	260	277	224	224	189	206	183
Royston (part of) ¹⁵	315	975	1,309	1,474	1,272	1,436	1,529	1,387	1,348	1,272	1,262	1,272
Rushden † § . . .	1,509	253	287	333	342	318	321	291	277	270	225	195
Sandon † § . . .	4,061	595	580	646	716	804	770	771	810	763	728	578
Therfield . . .	4,833	707	692	872	974	1,224	1,335	1,222	1,237	1,175	996	856
Wallington † § . . .	2,043	224	219	210	213	274	254	238	250	191	133	152
Yardley, or Ardeley † §	2,424	484	563	617	599	633	630	574	563	495	464	392
<i>Hertford Borough</i>												
All Saints (part of) ¹⁶	22	872	1,088	1,120	1,287	1,254	1,273	1,175	1,175	1,127	963	846
St. Andrew . . .	1,179	1,277	1,421	1,601	2,120	2,135	2,148	2,184	2,275	2,481	2,121	2,094
St. John * † . . .	2,138	1,211	1,391	1,544	1,840	2,061	2,282	2,388	2,756	2,987	3,357	3,506
<i>St. Albans Borough</i>												
St. Albans	166	1,911	2,152	2,819	3,092	2,904	3,371	3,679	3,946	4,097	4,434	4,467
St. Michael (part of) ¹⁷	—	287	382	453	517	1,140	1,091	1,253	1,214	—	—	—
St. Peter ¹⁸ † . . .	5,745 ^e	1,674	1,828	2,461	2,973	3,701	3,746	4,158	5,261	6,562	8,044	11,714

¹⁵ *Royston Parish*.—The remainder is in Cambridgeshire (Armingford Hundred). The entire population, however, is shown in Herts. in 1811 and 1821.

¹⁶ See note 13 above.

¹⁷ See note 7 above.

¹⁸ *St. Albans, St. Peter Parish* is partly in Cashio Hundred; none shown there.

GENERAL NOTE

The following Municipal Borough and Urban Districts were co-extensive at the Census of 1901 with one or more places mentioned in the Table :—

Municipal Borough or Urban District.	Place.
BISHOP'S STORTFORD U.D.	Bishop's Stortford Parish (Braughing Hundred).
CHESHUNT U.D.	Cheshunt Parish (Hertford Hundred).
HEMEL HEMPSTEAD M.B.	Hemel Hempstead Township (Dacorum Hundred).
STEVENAGE U.D.	Stevenage Parish (Broadwater Hundred).

INDUSTRIES

INTRODUCTION

EXCEPT malting, a natural outcome of its dominant agriculture, mediæval Hertfordshire had few industries of note. There was brewing, of course, in every village, largely a domestic trade, while tanning, a necessary craft, flourished in the towns. Besides malt, meal and fuel were carried to London; simple woodware, tiles, pottery¹ and rough cloth¹ of local manufacture supplied the homesteads. Later straw-plaiting¹ on a considerable scale, paper-making¹ and lace gained a footing, and brewing became an organized trade, as less and less ale was made by private persons. There also developed a considerable activity in the growing of water-cress¹ for the London market, and of late years an extension of nursery gardens. Our own day has seen the creation, especially at Watford, St. Albans, Barnet and Letchworth, of a factory industry, distributed among various trades, and drawn to the county by cheaper labour and greater opportunities of expansion than crowded cities can afford.

As regards land communications, there can be little doubt that most of the Roman roads, as Watling² Street, Ermine Street, Akeman Street and the prehistoric Icknield Street, continued to be the great arteries of traffic during the Middle Ages, but the Roman Way from St. Albans to Colchester was probably early disused. The direction of the London to St. Albans road was changed in the Tudor period.² The Great North Road was also in all likelihood of considerable antiquity. Arthur Young, at the beginning of the 19th century, speaks of six great leading turnpikes, and adds that there were 'many cross-roads nearly as good as turnpikes. The worst are found in the country between Pelham and Welwyn.' Before the days of Macadam, however, even the great trunk roads were sometimes in a deplorable condition from the continuous traffic and occasional floods. In 1680 Thoresby had described³ the road between Hoddesdon and

Ware as most pleasant in summer but 'bad in winter because of the depth of the cart-ruts.' Even in May the same traveller⁴ in 1695, when riding to London, speaks of some showers at Ware 'which raised the washes upon the road to that height that passengers from London that were upon the road swam; and a poor higgler was drowned.'

In respect of railway communications the county is well supplied as far as access to London is concerned, but the cross-country facilities leave much to be desired. This condition of affairs is easily understood when we consider the history of the early trunk lines. One of the earliest railways opened in Hertfordshire was that of the London and Birmingham line, for the construction of which an Act of Parliament was obtained in 1833. The original terminus was fixed at Camden Town, but removed to Euston⁵ under the authority of a further Act of 1835. The first section between Euston and Boxmoor was opened in 1837. According to a contemporary description, the first train on 13 July 1837 'proceeded very slowly to Camden, but soon accelerated its progress and was seen sweeping along like a meteor at the rate of 30 miles an hour.' The ordinary public traffic began a week later. On 16 October in the same year a further 7½ miles were opened from Boxmoor to Tring, and on 9 April 1838 the line from Tring to Denbigh Hall was ready for use. By an Act of Parliament passed on 16 July 1846 the London and Birmingham and the Grand Junction Companies finished their separate existence under these names, and the amalgamated company was henceforth known as the London and North Western.^{6a} On 5 May 1858 a branch line from Watford to St. Albans was opened for passenger traffic.⁶

The Great Eastern Railway has a lesser mileage actually within the County of Hertford than the other great trunk lines running north and south. The nucleus from which the present Great Eastern main line sprang was the old Eastern Counties line, incorporated in 1836

¹ Treated separately.

² It may also be remarked that since the original Roman Road ran to the west of the Ver, a portion of the modern road was made early in the second quarter of the 19th century in order to enter the city.

³ *Diary*, i, 68.

⁴ *Diary*, i, 295.

⁵ C. E. Stretton, *Hist. Lond. and Birmingham Railway* (ed. 2), 1 et seq.

^{6a} Local and Personal Act, 9 & 10 Vict. cap. 24.

⁶ See original official advertisement.

A HISTORY OF HERTFORDSHIRE

and partially opened three years later.⁷ This was intended to be an Essex line. The Hertfordshire portion of the Great Eastern, however, was principally formed from the old Northern and Eastern from Stratford to Cambridge, which had been granted the use of the Eastern Counties terminus at Shoreditch. In 1840 the Northern and Eastern line was open to Broxbourne, and soon after reached Bishop's Stortford on its way to Newport; thence the Eastern Counties extended the line to Cambridge.

The third great trunk line to be constructed, which passed through Hertfordshire with a terminus in London, was that soon to be known as the Great Northern. The London and York Railway Bill passed in June 1846, but the line from Werrington to Maiden Lane was not completed until 1850. Some delay had been occasioned during the winter of 1849-50 by keen frost, which stopped work on the Welwyn viaduct, and after this by the collapse of an arch of the North London Railway viaduct near the tunnel at Copenhagen Fields. By 5 August 1850, however, all difficulties were overcome, and the directors and their friends made a trial trip⁸ to Peterborough in four and a half hours, a considerable time having been lost at Welwyn, where the party went down to the valley to secure a better view of the viaduct. The first public train was three days later. The Royston, Hitchin and Shepreth Branch was opened in 1850 by the Great Northern Company, which guaranteed £15,000 a year to the Royston and Hitchin shareholders, but from 1 April 1852 the working of this line was taken over by the Eastern Counties for a term of fourteen years. In 1853 an independent company had been formed to build the Welwyn and Hertford Railway, 7 miles in length, to join the Great Northern and Eastern Counties lines. Originally it was worked by both these companies. By 1860 the Hertford and Welwyn line had been extended westward to Luton and Dunstable, and in 1861 it was absorbed by the Great Northern, which guaranteed the dividend⁹ on the shares of the local company. In 1864, in view of the approaching lapse of the agreement under which the Great Eastern was working the Shepreth and Hitchin line, the Great Northern obtained running powers from Shepreth over the Great Eastern. On 11 June 1866 took place the memorable accident in the Welwyn tunnel when three trains took fire. As regards the later development of the line in Hertfordshire, branches to Edgware and Barnet were opened up in the early 'seventies,' and under an Act of Parliament in 1883 the

Hatfield and St. Albans line was acquired.¹⁰ At the present time the Great Northern Company is constructing a new line from Cuffley to Stevenage, the section from Enfield to Cuffley having been opened in April 1910.

At the time when companies operating in the Midlands were amalgamated and incorporated as the Midland Railway in 1844, it had obtained no foothold in Hertfordshire. In 1847 an Act of Parliament had been obtained for the making of a line from Leicester to Hitchin, but this lapsed since the Midland were promised facilities on the North Western line from Rugby, and it was only under a later Act of 1853 that the Midland line through Bedford to Hitchin was constructed.¹¹ The Leicester to Hitchin line was opened for mineral and goods traffic in April 1857 and for passenger traffic the following month, running powers over the Great Northern being obtained to King's Cross early in the next year. The Midland, however, found themselves entirely in the power of their hosts, and the situation soon became impossible. A climax was reached in June 1862 during the Exhibition, when the Great Northern evicted the Midland from their sidings at King's Cross and dislocated their traffic. Accordingly in June 1863 the Midland Company obtained Parliamentary powers to make a line from Bedford to St. Pancras, but before this was opened built a goods station at St. Pancras and ran into it from Hitchin from January 1865. The Bedford line to the goods station at St. Pancras was opened on 7 September 1867. On 1 October of the following year the new passenger station at St. Pancras was opened and Midland trains were no longer run to King's Cross.¹²

The Hemel Hempstead Company had obtained an Act in 1863, amended by subsequent Acts, to make a short line beginning at Boxmoor on the London and North Western system, passing through Hemel Hempstead and Redbourn to the Midland and Great Northern systems at Harpenden. On consideration, however, they determined to commit the working to the Midland, and on 16 July 1877 the line, in a modified form, from the junction near Harpenden to Hemel Hempstead was opened and worked by the Midland. In 1886 the Hemel Hempstead Company was absorbed by the Midland Company.¹³

The extension of the Metropolitan Railway was opened as far as Harrow in 1880. From this station it was gradually carried forward until the line between Chalfont Road and

⁷ *Official Guide to the Great Eastern Railway*, 17.

⁸ Grinling, *Great Northern Railway*, 90 et seq.

⁹ *Ibid.* 204.

¹⁰ Grinling, *Great Northern Railway*, 366.

¹¹ C. E. Stretton, *Hist. Midland Railway*, 155.

¹² *Ibid.* 186.

¹³ *Ibid.* 159.

INDUSTRIES

Aylesbury was in working order in 1892. Two of the stations on this line, Rickmansworth (opened in 1887) and Chorley Wood, lie in Hertfordshire.

The chief mediaeval waterways in Hertfordshire were those of the Lea, the Stort and the Colne. By an Act of 1571,¹⁴ 'An Acte for the brynging of the Ryver of Lee to the north side of the Cite of London,' the Corporation of London were empowered to make a new cut or river within the space of ten years. Nothing, however, was then done, and on the lapse of the Act a Statute^{14a} was passed authorizing 'the bringing in of a freshe stream of running water' from the springs of Chadwell and Amwell and their vicinity. An amending Act¹⁵ empowered the grantees to convey the New River through a trunk or vault of brick or stone where requisite. William Inglebert, Captain Edmund Colthurst and Edward Wright submitted schemes, but nothing practical seems to have been done until Hugh Myddelton undertook the task. On 28 March 1609 the Corporation agreed to his proposal and transferred their rights to him. His chief difficulties arose from the selfish opposition of the local landowners, which lengthened the task and increased its cost. The king, however, came to his aid in return for a share in the undertaking, and on Michaelmas Day¹⁶ 1613 the citizens of London celebrated by a public pageant the arrival of the New River water at Islington. A few years after, in the winter of 1621-2, James I narrowly escaped death by drowning in 'Myddelton's Water' when it was thinly coated with ice.

The reign of Charles I saw extensive building in the neighbourhood of Lincoln's Inn Fields, Holborn, Covent Garden and the parishes of St. Martin, St. James and St. Giles. In consequence an increased water supply was desirable, and Edward Forde of Harting in Sussex published a 'Designe for bringing a navigable river from Rickmansworth in Hertfordshire to St. Giles in the Fields.' The water was to be derived from the Colne, and greater employment, cheaper carriage, relief to the highways and other benefits were confidently promised. London would enjoy more abundant supplies of food and water, and would send back manure in return. The water, too, would be fit for all uses, 'all land floods and foule waters which frequently occasion the muddinesse of Sir William Middleton's water being by artificiall conveyances diverted and kept wholly out of the stream.'

Sir William Roberts, however, had a rival scheme for an aqueduct from Hoddesdon to a

'Conserve' at Islington. When his proposals were brought before the Court of Aldermen they agreed, after some debate, 'that the close aqueduct would be far more usefull and beneficiall to them than an open river (as Myddelton's was) could be, since they wanted not water, so much as *good water*.' Roberts was particularly sarcastic in regard to Forde's assurance that the water of his navigable river would be always clear. His rival could not imagine that any understanding man could 'beleeve it, that is not a Catholique and led by an implicite faith.' But a larger quarrel was to hush minor wrangles. In the turmoil of the Great Rebellion both schemes were lost and Edward Forde rode forth to fight for the king. Later schemes for improving the London water supply from Hertfordshire were watched with jealous eyes¹⁷ by mill-owners and farmers and successfully opposed on more than one occasion.

The Grand Junction Canal connecting London with the Midland waterways was authorized¹⁸ in 1793. It enters Hertfordshire near Tring and is generally in good condition, though there are reasonable complaints of its slight width and occasional sharp bends. Barges use the main waterway between Brentford, Uxbridge and Rickmansworth and occasionally reach Boxmoor and Berkhamstead.¹⁹ Narrow boats only can be employed on the Wendover branch, which to the length of 6¾ miles was constructed mainly as a feeder under the Act of 1794. Early in the present century, however, the Canal Company closed²⁰ this branch for navigation from Tring Stop Lock, and only a mile and a half are still open for boats of shallow draught. Besides the coal brought down from the Midlands, the Grand Junction Canal still carries much of the raw material and finished products of the Hertfordshire paper-mills.

The navigable portion of the River Stort, some 13 miles in length, begins at Bishop's Stortford and passing Sawbridgeworth, Harlow,

¹⁷ B.M. Single Sheet, 816, m. 8 (36), of the date ? 1700.

¹⁸ The principal Statutes respecting the canal are the public Acts, 33 Geo. III, cap. 80; 34 Geo. III, cap. 24; 35 Geo. III, caps. 8, 43, 85; 36 Geo. III, cap. 25; Local and Personal Acts, 41 Geo. III, cap. 71; 43 Geo. III, cap. 8; 45 Geo. III, cap. 68.

¹⁹ H. R. De Salis, *Bradshaw's Canals and Navigable Rivers* (1904), 132 et seq. Esparto, wood pulp and other material brought up in Thames lighters to Brentford must be transhipped there into boats of smaller size. cf. *Canal Com. Third Rep.* v (2), Minutes of Evidence, 235 et seq.

²⁰ A law-suit followed, initiated by local landowners, to test the right of the Grand Junction Canal Co. to effect this closure. The action of the Company was, however, allowed.

¹⁴ Stat. 13 Eliz. cap. 18.

^{14a} Ibid. 3 Jas. I, cap. 18.

¹⁵ Ibid. 4 Jas. I, cap. 12.

¹⁶ Smiles, *Lives of Engineers* (ed. 1904), i, 92.

A HISTORY OF HERTFORDSHIRE

Parndon and Roydon joins the Lea at Fieldes Weir²¹ about 2 miles above Broxbourne. The narrow and winding water-course is at present much silted-up and impracticable for barges of greater burden than 50 to 60 tons, while the locks are mainly of old pattern and occasionally in poor repair. Malt is the chief cargo, but agricultural produce, bricks and coal are carried in small quantities. If larger barges drawing more water could be used, the cost would be much less. Some years ago the Stort Navigation was acquired by Sir Walter Gilbey, and is now in the hands of a small company.

The River Lea becomes navigable at the Town Mills,²² Hertford, and then passes Ware, Stanstead Abbots, Broxbourne and Waltham on its course to Limehouse, Bow Creek and the Thames. From very early times it was the highway by which the produce of Hertfordshire reached the great city. On this account care has been taken²³ to keep it open for traffic, though even in the Middle Ages there were complaints of silting and of obstructions caused by mills, weirs and kiddles. At present the 28 miles of navigable river between Hertford and the Thames are in good condition and can be used by barges and lighters. But this traffic suffers from the competition of steam and motor lorries as well as of the Great Eastern Railway. It has been suggested of late that the Rivers Lea and Stort should be connected by canal with Cambridge, and that thence by means of the Cam and Ouse a line of inland navigation between London and King's Lynn might be secured. This scheme is really a revival of a former project of the London and Junction Canal, for the making of which an Act of Parliament was obtained on the eve of the early railway activity, and probably on that account allowed to lapse. The enterprise, if carried out, would call for a thorough reconstruction of the Stort Navigation as well as for the making of the new linking canal. Until 1869 the Lea Navigation was under the control of the River Lea Trust, but on 1 April of that year the Lea Conservancy Board took over this responsibility.

From a consideration of the chief means of communication within the county we can now pass to the industries themselves. Of these malting is one of the oldest and most persistent, and allusions to it are frequent in legal

²¹ H. R. De Salis, loc. cit.

²² Ibid. 191.

²³ The principal Acts concerning the Lea Navigation are as follows: 3 Hen. VI, cap. 5; 9 Hen. VI, cap. 9; 13 Eliz. cap. 18; 12 Geo. II, cap. 32; 7 Geo. III, cap. 51; 19 Geo. III, cap. 58; 45 Geo. III, cap. 69; 13 & 14 Vict. cap. 109; 18 & 19 Vict. cap. 196; 31 & 32 Vict. cap. 154; 37 & 38 Vict. cap. 96; 57 & 58 Vict. cap. 205; and 63 & 64 Vict. cap. 117. cf. *Canal Returns* (1907), App. 301.

records. In 1339 we hear of a royal writ²⁴ to the bailiffs of Ware ordering the restitution of 12 quarters of malt which Master Reymond Peregrine, an Italian merchant and financier, had caused to be provided at the prebend of Leighton Bromswold for the expenses of his house in London, since these had been seized at Ware *en route* by John de Tebdych, a royal purveyor. The trade in malt between Hertfordshire and London was considerable. About 1478 William Symmes, 'a comon carior of malte,' appealed²⁵ to the Court of Chancery for redress. One John Pratte had hired him to carry 6 quarters of malt to Stratford-le-Bow to William Whitehead, brewer, who refused it as 'not gode nor holesum for man.' The next market-day Pratte met the carrier at Ware 'and ther arestid hym for the said malt, and wolde condempne hym ther in 38s. contrarie to all right and conscience.' The appellant begged a writ of *certiorari* directed to the steward of Ware. About the same time malting was an industry at Aldenham,²⁶ for Robert Mascall, a maltman of that place, found himself accused of abducting Joan Smythe, the apprentice of Alexander Eldwolde, a London citizen. The girl had already been in Mascall's service two years, when on a visit to London, 'as he must nedys do wekely by cause of his occupacion,' her new master, who had engaged her at first from 'compassion for goddys love and in way of almes more than for any other cause,' was arrested, Eldwolde affirming against him a plaint of trespass. Apparently Mascall refused to put himself on a verdict of a London jury 'in a mater of which by no possibilite of the lawe the[y] myght have verrey notice,' and he now applied for redress and enlargement to the Chancellor. Another action of the same period introduces Harry Hewet, maltman, who in an action of debt brought by Matthew Baldok, maltman, in the St. Albans Piepowder Court, had been prevented from waging his law by the abbot's steward.²⁷ A rather later case than these, which may be assigned to about the year 1510, shows us Edward Wyllson²⁸ proceeding against John Archer of Ware for the balance of a sum due for 20 quarters of malt. It was alleged that the defendant in the Common Pleas had waged his law 'forsweryng hymself upon a boke with xij other vntrue men called knyghtes of the post that he owed not the said residue.' Ware, Aldenham and St. Albans were only a few of the Hertfordshire places noted for malt. In 1514 Christopher Warde,²⁹ a brewer, was appealing

²⁴ *Cal. Close*, 1339-41, p. 135.

²⁵ Early Chan. Proc. bdle. 46, no. 218.

²⁶ Ibid. no. 387.

²⁷ Ibid. no. 463.

²⁸ Ibid. bdle. 369, no. 92.

²⁹ Ibid. bdle. 376, no. 63.

INDUSTRIES

for redress in Chancery against Thomas Paryse of Hitchin, who had refused to compensate him for many years' delivery of short measure of malt. The case was flagrant. For eight years Warde had bought weekly of this dishonest trader 'vij quarters malte and therfor well and truely contentyd and payd wekely to the said Thomas Paryse.' But Paryse 'all the said vij yeres vsed such sleight and deceytfull measures that your said Oratour lakked eury weke a pek of eury quarter malte, the which malt the said vij yeres amountith to 94 quarters malte for the which your said oratour hath contentyd and paide to the saide Paryse £21 18s. 8d. and had therefor noo thyng.' The results of these cases do not appear, but the facts recited are sufficiently suggestive of a considerable trade in malt between Hertfordshire and London.

In the 17th century the trade was still strong. Norden³⁰ reports malting in 1616 as the chief business of Great Berkhamstead. At Hitchin³¹ there existed a mill called 'Le Maltmilne.' Occasional entries in the Sessions Papers introduce us to maltsters offending against the ecclesiastical or civil regulations of the time. In 1615 it was presented³² that 'Thomas Maunsell of the parish of Muche Monden, maltman, standing excommunicate did upon the 9 July inst. disturb the minister and congregation in the parish church there, during the service time, so that the minister was enforced to break off his sermon and leave the church.' Some twenty-five years³³ after Isaac Fuller, late of Ware, maltster, was charged with keeping and using an illicit measure—to wit, a bushel contrary to the assize. But the chief concern of the justices with the maltster's trade was as to its effect on the roads. So active was the traffic that the justices³⁴ in 1631 advised that between Michaelmas and May malt brought from Royston to Ware should be carried on horseback to save the roads, since that part of the country was clay. But the maltsters appear to have done their best to evade the order. In 1646-7 the men of Ware presented³⁵ that 'the great decay of all the ways arises through the unreasonable loads of malt brought into and through Ware to Hodsdon from remote parts, and the bringing of great loads of malt from both the Hadhams, Alburie, Storfod all the Pelhams and Clavering through Ware Extra and the excessive loads from Norwich, Bury and Cambridge weekly, the teams often consisting of

seven or eight horses.' They further noticed that there had been a great increase of maltsters in Ware and suggested that if the maltsters would carry lighter loads with only four horses as they used to, and each person would duly perform his work, the ways could be sufficiently amended. Attempts would seem to have been made to discourage malting in Hertfordshire during the reign of Charles I, possibly on the advice of economic theorists in London, and in consequence about 1636 the Hertfordshire justices drew up a statement³⁶ of the inconveniences and damages which are discovered to arise in that county from the restraints of malt-making and chiefly in the towns of Stortford, Hitchin, Baldock, Ashwell, Royston and other of the champaign parts of the county. 'The most maltsters in that county,' according to this memorial, were 'of mean ability, and are chiefly employed by gentlemen and others who send their barleys to them to be malted for the provision of their houses; also widows, the portions of orphans, servants who have some small stock and others who like not to put their money to usury buy barley and hire the making of it by the quarter. These poor maltsters are very useful to the county, pay good rents and have borne all taxes. So in the villages many petty maltsters make malt for themselves and supply the markets; they bear offices and pay taxes, but being restrained, must turn day-labourers, of whom many already want work. So again malt making continued little more than half a year; many mechanics and men of small trades employed their wives, children and servants in malt making whilst themselves followed other callings.'

Large quantities of malt continued to be made in Hertfordshire during the 18th century, especially round Ware and Hertford, for consumption in London,³⁷ and the improved water communication of the Stort Navigation gave fresh life to the industry at Bishop's Stortford. From Ware no less than 5,000 quarters of malt and corn used to be sent in a week to London by barges.³⁸

Even in the middle of the last century malting remained the most important of the industries of the county. At Ware there existed no less than seventy malt-houses, and most of the London breweries were still supplied from this town.³⁹ In northern Hertfordshire the excellent barley grown in the neighbourhood was largely used at the malt kilns of Ashwell and Baldock.⁴⁰ In fact,

³⁰ *Speculum Brit.*

³¹ Pat. 7 Jas. I, pt. xxxiii.

³² *Sess. R.* (Herts. Co. Rec.), i, 44.

³³ *Ibid.* 65.

³⁴ *Cal. S. P. Dom.* 1631-3, p. 66.

³⁵ *Sess. R.* (Herts. Co. Rec.), i, 86.

³⁶ *Cal. S. P. Dom.* 1636-7, p. 323 et seq.

³⁷ Walker, *Gen. View of Agric. of Herts.* (1791), 73.

³⁸ Samuel Simpson, *The Agreeable Historian* (1746), 263.

³⁹ Lewis, *Topog. Dict.* (1849), iv, 464.

⁴⁰ *Ibid.* i, 96, 133.

A HISTORY OF HERTFORDSHIRE

these two towns together with Hitchin and Hertford were famous for the high quality of this commodity.⁴¹ Malting is still, in the 20th century, one of the prominent industries of the shire.

In the Middle Ages brewing was a universal^{41a} and necessary industry, and hardly any series of manor or borough rolls but contains references to its conduct, to local rates levied on the trade or fines for infraction of regulations which were rarely observed. It is of interest to inquire when 'beer' or hopped ale was first brewed in the county, but little evidence exists. But this may be said, it was probably introduced by aliens. In a will of 1504, connected with Ware, is a bequest to 'the Dutchman (the beer brewer).'⁴²

One of the earliest public breweries in Hertfordshire was the Cannon Brewery at Watford. It was certainly in existence⁴³ in 1750, and for two generations belonged to the Dyson family, by whom it was sold to Mr. Joseph Benskin in 1868. By him the trade was energetically developed and a new brew-house built. On Mr. Benskin's death in 1877 the business passed to his widow and his son Mr. J. P. Benskin, and in 1884 Mrs. Benskin retired from the firm in favour of her younger son Mr. Thomas Benskin. In the following year his elder brother also retired, owing to ill-health, and the younger son was joined by a member of a famous Dorsetshire brewing family, Mr. J. A. Panton, who had made a scientific study of his craft under Professor Graham at University College, London. The trade of the Watford Brewery was now rapidly extended and the latest improvements in the craft introduced. In July 1894 Benskin's Watford Brewery Company, Ltd., was registered, and in January 1898 was reorganized to acquire the King's Langley Brewery, the Kingsbury (St. Albans) Brewery and Healey's King Street Brewery, Watford. In the autumn of the same year the further capital was raised in order to take over the brewery of Hawkes & Co. of Bishop's Stortford, which had been originally established in the 18th century. The famous ales of this great brewery have a well-deserved reputation far beyond the county boundaries, and at the Brewers' Exhibition of 1912 the company obtained a first prize of a silver medal for a naturally matured India pale ale in bottle. Quite lately a thoroughly

⁴¹ G. A. Cooke, *A Topog. and Statistical Descr. of the County of Hertford* (1825), 69, 74.

^{41a} In 1355 no less than 79 brewers were fined at St. Albans, most of them being engaged in other industries as well. At Royston among the delinquents was Master Thomas 'Scolemaistre' (Coram Rege R. 377).

⁴² Will, P.C.C. 4 Holgrave.

⁴³ Barnard, *Breweries of Great Britain*, 85.

modern installation of bottling machinery has been added to the plant.

Another important Hertfordshire brewery amalgamation was that of the Hatfield and Harpenden Breweries in 1902, by which the firms of Glover & Sons, Ltd., of Hatfield and Messrs. Pryor, Reid & Co., of Hatfield and Hertford, were joined. Among other Hertfordshire brewery firms or companies may be mentioned such well-known names as Christie & Co., Ltd., of Hoddesdon, E. K. & H. Fordham, Ltd., of Ashwell, Locke & Smith, of Berkhamstead, McMullen & Sons, of Hertford, Messrs. J. & J. E. Phillips, Ltd., of Royston, T. W. Kent & Son, and M. A. Sedgwick & Co., to mention only a few out of many. Some Hertfordshire brewers also manufacture mineral waters and other beverages, as, for example, Barley's Brewery at Bishop's Stortford. At the present day no material differences have been made in the chief ingredients employed in brewing from those in use a century ago. A noticeable feature lies in the fact that beer of much lighter gravity is now preferred to the dark, heavy variety in general vogue fifty years ago. There is also a strong demand, which seems to be on the increase, for all 'beers' (including stout and porter) supplied in bottle. There is, however, no regular production of lager beer from any of the Hertfordshire breweries.⁴⁴

In the Middle Ages cider was occasionally made on Hertfordshire manors, but less commonly than in the counties south of the Thames. At the manor of La Hyde⁴⁵ in Sawbridgeworth in 1284 we hear of 20s. received for two casks of cider, the produce of the garden. In the year following, four casks of cider were made of 40 quarters of apples, and the liquor sold at 8s. the cask. Again in 1288, 2½ quarters of apples, less the tithe, furnished 60½ gallons of cider. About the middle of the 18th century, however, William Ellis was obliged to confess 'In Hertfordshire⁴⁶ we are bad cyder makers, and therefore are not so curious as we ought to be in planting the Redstreak, Gennet Moyle and those trees that are most fitting for this purpose.' He also names⁴⁷ the Holland Pippin as 'one of the farmer's best apples, supplying his cellar with cyder and pomepirk,' and the Parsnip Apple 'to make a cyder for present drinking.' The Lemon Pippin could also be used, and even the Golden Rennet made a 'tolerable cyder, but not so fine a sort as the pippin produces.' The best Holland Pippin cider, however, which he had ever tasted was made just outside the

⁴⁴ Inform. from Mr. F. Eaton.

⁴⁵ Mins. Accts. (Gen. Ser.), bdlc. 868, no. 1.

⁴⁶ Ellis, *Husbandry*, i, 140.

⁴⁷ Ibid. 138 et seq.

INDUSTRIES

borders of the county at Ivinghoe Arson (Aston), in Buckinghamshire. Perry was also occasionally made in Hertfordshire in the 18th century. Ellis declared⁴⁸ that with his fine golden-coloured orange pears in a plentiful year he made a 'most charming perry.' His procedure was as follows: 'For Perry⁴⁹ we stamp or grind the orange pears in August, or September at farthest; and if we can then get some ripe, sharp apples, wildings or crabs we mix them with the pears, and press all together to lessen the extraordinary luscious taste of this fruit, which, with right management, afterwards will become an agreeable perry for early drinking.' By further racking and proper ingredients it could be kept for a winter liquor 'which as soon as in the cask yields a scent so much like an orange that few can believe it that never proved it.' By the beginning of the 19th century, however, whatever industry may have existed appears to have died out. G. A. Cooke, writing in 1825,⁵⁰ in describing orchard cultivation, states that no apples grown in Hertfordshire were then used for cider.

The county possesses no historic quarries, though a little grey limestone of the Totternhoe⁵¹ type has been got for local buildings. Beds of phosphatic modules and worn Gault fossils, whether belonging to the Upper Greensand or the Chalk Marl, were largely worked in the past, as in the neighbourhood of Hitchin and Ashwell. The digging of gravel for road-metal is also a decreasing industry, since Leicestershire syenite has been brought to the south. The chalk⁵² obtained from quarries, of sufficient size to be liable to Government inspection, amounted in 1911 to 29,335 tons. One thousand five hundred and eighty-one tons of flint and 12,516 tons of clay were also returned for that year.

Medicinal springs, which apparently were fitfully exploited, have been discovered at East Barnet, Hemel Hempstead and other places.⁵³

The woodlands⁵⁴ of Hertfordshire furnished in the Middle Ages excellent timber, and then, as now, Berkhamstead was an important centre of the trade. In 1591-2 wages⁵⁵ were fixed under the Statute of 1562-3^{55a} for

woodmen, and the following rates were enjoined:—

'Cleaving of lathe by the hundred not above 3*d.*

'Cleaving of pale by the hundred not above 6*d.*

'Felling and hewing of colewood by the dosin not above 12*d.*

'Felling, makeinge and buynding of baven by the hundred, accomptinge six score to the hundred, every baven beinge fower foote in lenghte, not above 14*d.*

'And for every lode of talewood 4*d.*

'Makinge and buyndinge of brushe baven by the hundred, after six score in the hundred made of ramell left of colewood, not above 8*d.*'

Charcoal-burning was a widespread industry from the earliest times, and this fuel not only found a local market, but was probably carried to London. Even toward the close of the 15th century the charcoal produced on certain manors was a source of considerable profit. In an account⁵⁶ of 1475 for Sir John Say's manors of Bedwell, Little Berkhamstead and Lowthes we find that 62 cartloads of charcoal made from underwood cut in Bedwell Park and elsewhere brought in £2 18*s.* 4*d.* The trade long continued, and in 1606-7 the inhabitants of Stanstead⁵⁷ were greatly annoyed by 'the making of wode,' so that not only the inhabitants but strangers were 'constrained to stope their noses as they go bye, the stinke is so greate.' Much later, in 1804, Arthur Young, in his account of the Earl of Clarendon's park at Grove, speaks of beeches burnt for charcoal.⁵⁸

Woodware, as might be expected, was always a local industry in the forest regions.^{58a} In the 18th century the trade was still brisk in the county. William Ellis writes in enthusiastic terms of the fine long hedges of alder in the water meadows between Hemel Hempstead and Watford. Their large high poles were turned to great account among 'the Berkhamstead and Cheshunt turners of hollow ware, who in this commodity make more consumption of this wood and beech than any other two towns in Great Britain, as is allowed by good judges; for with this wood they make dishes, bowls, and many other serviceable goods that are lighter and softer than the beech or elm, and will bear turning thinner than most others; so that to please

⁴⁸ *Husbandry* (1750), vii, 147.

⁴⁹ *Ibid.* 141.

⁵⁰ *Op. cit.* 32.

⁵¹ *cf. V.C.H. Herts.* i, 8 et seq.

⁵² *Gen. Rep. Mines and Quarries*, pt. iii (1912), 214 et seq.

⁵³ G. A. Cooke, *op. cit.* 91, 164 et seq.

⁵⁴ Hertfordshire is described as 'ful of wode' in an early MS. entitled the 'Characteristics of Counties,' published in Hearne's edition of Leland's *Itin.* v, p. xxvi.

⁵⁵ *Sess. R. (Herts. Co. Rec.)*, i, 11.

^{55a} *Stat. 5 Eliz. cap. 4.*

⁵⁶ *East Herts. Arch. Soc. Trans.* iv (2), 193. *cf.* the 'puteos carbonum' at Knebworth (*Harl. Roll* 13).

⁵⁷ *Sess. R. (Herts. Co. Rec.)*, i, 37.

⁵⁸ *Gen. View of Agric. of Herts.* 146.

^{58a} In this connexion we may notice the number of wheelwrights in south-western Hertfordshire in the 14th century. In 1355 eight were fined at Rickmansworth, four at Wheathampstead and six in the liberty of Berkhamstead (*Coram Rege R.* 377).

A HISTORY OF HERTFORDSHIRE

Harkness & Son, of Hitchin, are but a few of the important growers.

In connexion with this industry, however, it may be stated that in the first half of the 19th century, at Munden and at Brookmans, both in Hertfordshire, were formed two of the earliest and most important rose gardens in England,⁸¹ a fact which may have had a material influence upon the present industrial aspect of this type of horticulture. Reference may also be made to the extensive orchid

nursery of Messrs. Sanders at St. Albans, which has now been in existence for over a quarter of a century.

The industrial position of Hertfordshire is probably at the present time stronger than ever before. The absence of coal and mineral wealth renders it unlikely that any exceptional development can be looked for, but the prospect of a lower wages bill and the provision of cheap electric power may do much to attract manufacturers from the great towns.

TEXTILES

Although a certain amount of cloth was produced in this as in all other counties, Hertfordshire has never been a great cloth-making district. It did not even take a prominent place in the production of the raw material, wool, though St. Albans was amongst the religious houses from which the Italian merchants bought wool in the late 13th and early 14th centuries.¹ At that time the price of the St. Albans wool was set at 10 marks the sack. In 1337, when prices were fixed for wool produced in different districts,² that grown in Hertfordshire and Essex was put at 7½ marks, rather below the average price. The two counties are here classed together, but, while Essex became one of the greatest centres of the cloth trade, Hertfordshire never attained eminence in this direction.

The chief centre of the industry in this county was in early times St. Albans, where it was clearly well established by the end of the 12th century, as in 1202 the men of that borough paid 2 marks to King John to have the right to buy and sell dyed cloth as they used to do in the time of Henry II.³ Hertford was another centre, but at Ware there were no dyers or weavers before the war between John and his barons, though some settled there immediately after that war.⁴ For the most part the early history of cloth-making in this county consists of isolated references to individual craftsmen and fulling-mills. John, Abbot of St. Albans, granted a fulling-mill at Cassio, in Watford, to Petronilla de Ameneville in 1255,⁵ and a fulling-mill in Hemel Hempstead was confirmed to the canons of Ashridge in 1290, and continued in use for at least three centuries, being referred to in 1540 and again in 1580, when there were

two mills under one roof.⁶ There was one such mill at King's Langley in the time of Edward I,⁷ and there was another at Standon at least as early as 1337, when 'a cord of bast' and other things were bought for the fulling-mill,⁸ which was leased next year for 26s. 8d.⁹ At Gilston, near Sawbridgeworth, Gilbert le Fulur held a fulling-mill in the last quarter of the 13th century; this he granted to Thomas le Chalunour (the maker of chalons or coverlets), who had married one of his daughters, but its possession was disputed in 1286 by his other daughters, one of whom had married John le Deghere (the dyer).¹⁰

At the assizes of 1247 Robert Stanhard was convicted of stealing woollen cloths from the fulling-mill below Eywood, near St. Albans,¹¹ and the importance of the industry in that town is shown by the appearance of the name Fullerstrete in the 13th century.¹² In one case, in 1266, land in 'the street of the fullers' is said to adjoin the 'tentorium' (tenterground, or place for stretching cloths) of Richard son of Robert.¹³ It was just about this time that the question of the fulling of cloths led to serious disputes between the abbot and the townsmen of St. Albans.¹⁴ The abbot claimed that all cloth made locally, and especially all thick and coarse cloth, must be fulled at the abbey mill. This claim was resisted, and in 1274 the townsmen began setting up mills in their own houses and fulling their own coarse cloth. The abbot retorted by sending his officers to distrain the refractory townsmen, taking from one of their leaders, Henry de Porta, who had set up a fulling stock in his

⁸¹ See Will. Paul, F.H.S., *The Rose Garden* (ed. 10), 26.

¹ Cunningham, *Hist. of Industry and Commerce*, ii, 626.

² *Cal. Close*, 1337-9, p. 149.

³ *V.C.H. Herts.* ii, 477.

⁴ Assize R. 318, m. 6b.

⁵ *V.C.H. Herts.* ii, 452.

⁶ *V.C.H. Herts.* ii, 221.

⁷ *Ibid.* 237.

⁸ Mins. Accts. bdl. 868, no. 22.

⁹ *Ibid.* no. 23.

¹⁰ Assize R. 328, m. 35.

¹¹ *Ibid.* 318, m. 26 d.

¹² e.g. Cott. MS. Jul. D iii, fol. 1, 55, 58.

¹³ *Ibid.* fol. 55.

¹⁴ Walsingham, *Gesta Abbatum* (Rolls Ser.), i, 410-17.

INDUSTRIES

house in Fullerstrete, a russet cloth worth 30s. The townsmen made a general levy to raise funds for litigation, and also assembled in a body to meet Queen Eleanor when she came to visit the abbey. The abbot endeavoured to outwit them by bringing the queen round by a different way, but the townsmen and the women, 'whose attack was formidable since it is hard to put reasonable bounds to the anger of women,' forced their way in and appealed to her. The queen rebuked the abbot for trying to keep the people from her, but, whatever her feelings may have been in the matter, the law was on the side of the abbot, and although the townsmen appealed against the first verdict the retrial resulted in the confirmation of the abbot's claim. The dispute broke out again early in the reign of Edward III, when the townsmen succeeded in extorting from the abbot a charter giving them the right to full their cloth elsewhere than at the abbey mill. This, however, they soon had to relinquish.¹⁵

A list of tradesmen¹⁶ drawn up for some purpose in the reign of Edward III gives twelve weavers, six fullers and five dyers in St. Albans and three weavers and three fullers in Hertford. Another list of persons fined for infringing various trade regulations in 1355 names at St. Albans eleven weavers, five fullers and two dyers and at Hertford three fullers; two dyers are mentioned at Buntingford and a fuller at Ware. There were also nine wool merchants at Baldock.^{16a} In the next reign the number of the Hertfordshire clothworkers was small, and their output insignificant compared with many counties. The accounts of the subsidy of 4d. on every broadcloth for the year 18-19 Richard II¹⁷ show the names of twenty-seven producers in St. Albans, of whom the chief were Thomas Carter, with fifteen cloths; Robert West, with ten; John Halgate and John Hawkwode, with five each. Hertford had only five names, Berkhamstead thirteen, but all responsible for very small amounts, Ashwell and Hitchin fifteen, of whom none produced more than four cloths, and Buntingford with Royston thirty-six names, of whom William Serle had six cloths, but no one else more than three. The total amount of cloth produced for sale in the county during the year was 198 cloths, or the equivalent, for a considerable part of the output consisted of narrow 'dozens,' of which four were equal to one whole cloth. In the similar account for 21-2 Richard II¹⁸ there are thirty-two makers of whole cloths, averaging

two each, not assigned to any particular towns, but of the three largest producers—John Sextry, with ten cloths, John Hawkwode and Thomas Carter, with nine each—the two last-named occurred in the earlier list as belonging to St. Albans. In the same list, under 'narrow cloths,' Royston had sixteen names (four of whom, including William Serle, produced twelve 'dozens' or upwards), Baldock three, Buntingford two, Hitchin and Codicote ten; Stortford, Hertford and Ware, together, eight. In the account for 3-4 Henry IV¹⁹ only nine names are given for the whole county, the largest amount, nine 'dozens' of narrow cloth, being put down to Simon Sebern of Hitchin, which town Lewis in his *Topographical Dictionary* (1849) says was 'celebrated at an early period for woollen goods.' His further statement that 'many of the merchants of Calais resided in the place prior to the removal of that branch of business from the towns on the continent' cannot be verified.

Some idea of the cloths manufactured may be gleaned from cases in which pieces were forfeited for neglect of the regulation by which all cloth exposed for sale had to be sealed by the ulnager, or for other reasons. At St. Albans in 1423 were seized²⁰ 6 yards of red cloth worth 5s., 11 yards of 'lyght blew medley' worth 9s., 15 yards of 'persed blew' worth 15s., 12 yards of green worth 12s., 4 yards of light blue worth 2s. 8d., 8 yards of white russet cloth worth 5s. and 4 yards of black russet cloth worth 2s. 4d. In 1440 the forfeitures returned were nine pieces of woollen cloth of divers colours called 'remenaunts' belonging to John Panfeld of Stortford, and two pieces of narrow russets of Walter Helder of Buntingford.²¹ Rather earlier, in 1396, the ulnage accounts²² include a payment from John Stowe for 'a dozen of broad cloth of stout blanket (*de robusto blanketto*).' John Studley of St. Albans is described as a 'straylwever' in 1438,²³ 'strayle' being apparently a coarse sort of blanketing used for bedclothes. Almost the only other reference to material occurs in a long list of cloths forfeited in London in the early years of Elizabeth. Hopkin Albre, clothier, of Hertford (the only Hertfordshire name in the list), was fined for a 'fryse,' or frieze cloth, lacking one pound in weight.²⁴

Whether the absence of other Hertfordshire names from this list of defaulting clothiers was due to their greater honesty or the smallness of their output may be left uncertain, but it would seem that even the small amount of cloth-

¹⁵ Chan. Misc. bdle. 62, file 5, no. 198.

¹⁶ Exch. K.R. Accts. bdle. 399, no. 14.

^{16a} Coram Rege R. 377.

¹⁷ Exch. K.R. Accts. bdle. 342, no. 8.

¹⁸ Ibid. no. 11.

¹⁹ Exch. K.R. Accts. bdle. 342, no. 17.

²⁰ Ibid. no. 20.

²¹ Ibid. no. 21.

²² Ibid. no. 11.

²³ *Herts. Gen. and Antiq.* ii, 238.

²⁴ Memo. R. (Exch. K.R.), Hil. 7 Eliz. m. 331

A HISTORY OF HERTFORDSHIRE

making which had formerly existed in the county was dying out, for in 1588, when the authorities at St. Albans wished to set the unemployed to work at spinning, they put the matter into the hands of Anthony Moner, 'Dutchman' or German.²⁵ It is also noteworthy that the necessary machinery 'for spinning and weaving worsted' was obtained from Hertford. The articles bought are described as 'a new great loom and two flayes, one for silk and the other for cruell, and all that belongs to them—£3 15s.; two little looms, one for silk and the other for cruell, 21s.; seven wheels, 36s.; wheels to wind yarn, 20d.; three blades, 16d.; things to lay on the warp, 8d.; the warping pins that belong to them and four dozen of quills, 6s.; one hartle, 8d.; two keeles, 16d.; a pair of combs, 15d.' The references in these details to silk are rather puzzling, as the cloth made seems to have been mainly, if not entirely, woollen. In September 1588, three months after the machinery had been bought, the constables were ordered to report as to how many poor children might be spared to be taught spinning by the Dutchman.²⁶ In November Mr. Thomas Woolley was commissioned to expend £10 on wool to be retailed to the Dutchman by 2 tods at the time.²⁷ Then in January 1589 Anthony Moner entered into a formal agreement²⁸ to teach children to spin in six weeks, after that time paying them for their work, and next month he undertook to teach four men to comb and dress wool. He was to pay to 'the Company' (? of Mercers) 3d. for every pound dressed, and to pay the children for spinning 2s. a pound for the best, 1s. 4d. for the second sort, and 8d. for the third sort.²⁹ The further history of this experiment is unfortunately not recorded.

Twenty years after this experiment at St. Albans the Earl of Salisbury, who had just obtained the Hatfield estate, inaugurated a similar scheme at Hatfield, the following agreement being made with Walter Morrall, of Enfield, in December 1608:³⁰

The said Walter Morrall will, at his own cost, at all speed after the date hereof, for the term of ten years diligently teach within the parish of Hatfield, Herts., in the art of clothing, weaving, spinning, carding, or any other such-like commendable trade which the said Walter shall think good, fifty persons to be chosen by the earl within the said parish of Hatfield but of no other place; out of which fifty persons the said Walter is to take apprentices for seven years not under the number of twenty persons, pro-

vided always that if by death or otherwise there shall at any time be less than the full number, the rest shall be supplied by the direction of the said earl and the number of apprentices shall always be fully maintained. And also the said Walter Morrall shall find stuff and work enough to set all these fifty persons at work, so as to avoid idleness and also for the education and teaching of them in skill and knowledge of the said trades for the better getting of their honest livings afterwards. And shall also pay to the said fifty persons (except such as he shall take apprentice) for their work such rates as are usually given in Essex and elsewhere for the like work. And that the said Walter shall pay the said wages after the rates aforesaid to each of them at the end of each week during the term of ten years without fraud.

In return the earl agreed to give him a house in Hatfield rent free, and to pay him yearly £100 during the ten years, arrangement being made for certain deductions in the event of Walter Morrall allowing the number to fall below fifty. Further stipulations were made that the persons employed should be well treated, should attend the parish church on Sundays, and should not teach the trade to any other until they had themselves practised it three years, and also that Morrall should always keep ten looms in his house. Beyond the fact that this scheme was actually put into operation nothing more appears to be known of it.

Little remains to be said of the textile industry in the county. Casual references show that it existed in various parts; for instance, at Elstree we find the marriage of Thomas Fenn, silk weaver, in 1667,³¹ and in 1669 Thomas Bigg, of Chipperfield, issued a token bearing the weavers' arms. At Watford the name of Jeremiah Smith, weaver, occurs in 1676,³² and at St. Albans we have mention of Thomas Reynolds, dyer, and John Mathew, weaver, in 1672,³³ Henry Andrews, weaver, in 1676,³⁴ and Thomas Morgan, dyer, in 1714.³⁵ In 1801 Young³⁶ noted an inconsiderable amount of spinning from Hockerill to Ware, Hadham and Buntingford, and added that it was not increasing.

About this date a silk-mill and a flock-mill were built at Rickmansworth,³⁷ and a fair amount of horsehair chair seating appears to have been made there during the next half-century.³⁸ In 1824 a silk-mill was set up in Brook Street, Tring, which was in the hands of

³¹ *Herts. Gen. and Antiq.* i, 362.

³² *Ibid.* ii, 167.

³³ *Ibid.* 95.

³⁴ *Ibid.* 141.

³⁵ *Ibid.* iii, 377.

³⁶ *Gen. View of Agric. of Herts.* 222.

³⁷ *V.C.H. Herts.* ii, 372.

³⁸ Osborne, *Guide to the Gd. Junction Rly.* (1838), 107; A. Freeling, *The Rly. Companion from Lond. to Birm.* (c. 1842), 61.

²⁵ Gibbs, *Corp. Rec. of St. Albans*, 28.

²⁶ *Ibid.* 32.

²⁷ *Ibid.*

²⁸ *Ibid.* 34.

²⁹ *Ibid.*

³⁰ *Trans. St. Albans Arch. and Archit. Soc.* (New Ser.), i, 350-1, from S. P. Dom. Jas. I, xxxviii, 73.

INDUSTRIES

David Evans & Co. in 1873, but is no longer worked.³⁹ In 1838 this factory engaged 500 hands, and a contemporary writer⁴⁰ states that steam and water power were employed, the weekly wages bill being as follows: superintendent, £1; men, 12s. to 15s.; women, 5s. 6d.; children, 3s. From the same source we know that the maximum number of hours daily for infant labour was fixed at ten, and twelve for adults. In the same town⁴¹ and at Ware⁴² there appears to have been a fairly considerable manufacture of canvas. At Tring there were four manufacturers employing 100 people. In this industry hand-loom were used, and the rate of wages appears to have been somewhat higher, the men receiving 16s. per week. The Tring people claimed to have commenced this trade prior to any other town in England. At Watford there were three silk-mills in 1838,⁴³ and in 1849 three mills for throwing silk,⁴⁴ one of these being presumably the Rookery Silk Mill, which was closed before 1881,⁴⁵ and at

St. Albans a silk-mill occupying the site of the abbey mill employed 300 young persons,⁴⁶ which still continues, while there was also a mill for spinning cotton wicks; possibly the same mentioned in 1795.⁴⁷ According to a writer in 1838 this factory was formerly devoted to lapidary work.⁴⁸ There are also at the present time the St. Edmundsbury Weaving Works at Letchworth, and mention may also be made of the Nicholson Rainproof Coat Company at St. Albans.

At the Ickleford Industries of Applied Arts of Mr. Walter Witter a successful attempt has been made to revive artistic craftsmanship in a country village. At the present time about ninety persons, all from the neighbourhood, are regularly employed.⁴⁹ The work is by no means confined to textiles, but special attention is given to the reproduction and restoration of old needlework, and the enterprise has won not only in Great Britain, but on the Continent and in America, an excellent repute.

THE STRAW PLAIT, HAT AND BONNET INDUSTRY

The county of Hertford probably owed its former high repute for the industry of straw-plaiting to soil peculiarly favourable to the growth of the varieties of wheat-straw known as Nursery and Red Lammas, both of which were in great, and, indeed, in almost exclusive, demand amongst straw-plaiters.¹ Tradition assigns the introduction of the industry into this and the adjacent counties to the patronage bestowed by Mary Queen of Scots on a colony of Lorraine immigrants whom she established in the first instance in Scotland, and who were afterwards brought to England by her son, James I. Mr. Thomas G. Austin, of Luton, an expert historian of the handicraft, gives the following account of its beginnings:—

The fair and ill-fated Mary Queen of Scots, when travelling in her mother's country, Lorraine, found numbers of women and children employed, some in plaiting straws and others in working the straw plait into hats. Noticing that these poor people seemed better off than their non-plaiting fellow country folk, she took some of them with her, settled them in Scotland in or about the year 1552 under her immediate

protection, in order that the handicraft might be learnt by her own subjects. Before, however, her laudable projects could bear fruit, cruel destiny overtook her. The Lorrainers, however, were not deserted, for her son, James VI of Scotland and I of England, brought them to England, finding a suitable shelter for them under the Napier family, who were personal friends of the Anglo-Scottish king, and at that time (1600) owners of Luton Hoo.²

Straw plaiting, however, must have been an industry of the English countryside, wherever suitable material was available, in Elizabethan times, if not earlier. Shakespeare writes of maidens wearing 'platted hives of straw,'³ of the 'sheav'd hat,'⁴ and the 'rye-straw hat'⁵; whilst in 1530 letters of denization were granted to one Martin Johnson, a native of Guelders, who is described as 'a strawen hat maker,' or 'splyter hatmaker.'⁶ By Stuart times the industry was firmly established in Hertfordshire, the fame of St. Albans, still a thriving seat of the trade, being, at that epoch, chiefly derived from 'straw, tankards and pots.'⁷ Pepys, while staying at Hatfield in 1667, relates that

³⁹ *V.C.H. Herts.* ii, 281.

⁴⁰ Osborne, op. cit. 124.

⁴¹ *Ibid.*

⁴² G. A. Cooke, *A Topog. Descr. of the County of Herts.* 44.

⁴³ Osborne, op. cit. 106.

⁴⁴ Lewis, *Topog. Dict.*

⁴⁵ *V.C.H. Herts.* ii, 453.

¹ *V.C.H. Herts.* ii, 135. Straw suitable for plaiting was never grown, says Arthur Young, on stony or heavy land. 'Weak straw grown under hedges and near trees was best' (*Gen. View of Agric. of Herts.* 224).

⁴⁶ Lewis, *Topog. Dict.*

⁴⁷ Walker, *Gen. View of Agric. of Herts.* 73.

⁴⁸ Osborne, op. cit. 110.

⁴⁹ From inform. kindly furnished by Mr. Walter Witter.

² Austin, *The Straw Trade*, 15.

³ Shakespeare, *A Lover's Complaint* (1597).

⁴ *Ibid.*

⁵ *The Tempest*, Act iv, Sc. i, 136.

⁶ Page, *Denizations and Naturalizations* (Huguenot Soc.), 136.

⁷ *Hist. MSS. Com. Rep.* xiii, App. ii, 274.

A HISTORY OF HERTFORDSHIRE

the ladies of the house-party 'had the pleasure of putting on some straw hats, which are much worn in this country, and did become them mightily, but especially my wife.'⁸ The 18th century was the golden age of the straw plait industry. 'Several thousand plaiters,' states Oldmixon, in his *Critical History of England*, 'found profitable employment' in this century in the counties of Bedford and Hertford. According to the testimony of Arthur Young⁹ and other travellers in the district where the industry flourished, the earnings of straw plait workers were very great and its effect upon the rates very beneficial. By the farmers, however, this cottage handicraft was viewed with anything but favour, in spite of the good account to which, in consequence of the demand for straw, they were able to turn this part of their wheat. They considered, says Young, 'that it did mischief, making the poor saucy, rendering the women averse to husbandry, and causing a dearth of indoor servants and field labourers.'¹⁰ This state of things was not to be wondered at. Women found the 'straw work,' as it was called, no less profitable than it was pleasant. At St. Albans women could earn 5s. a day at the close of the 18th century and the opening of the 19th. A guinea a week could be earned by mere children. This, indeed, was the weekly wage of a girl of thirteen at Gorhambury.¹¹

Women at Redbourn earned a guinea a week; at Berkhamstead a good hand could earn from 14s. to 18s. a week. Mrs. Munns, of Market Street, was a great buyer of 'twist,' which she bought at 4s. the score, or 30 yards, from the poor of the neighbourhood, making it up into bonnets.¹² The work was almost exclusively in the hands of the female population—women, girls, and children, the men taking but a small part in the work, their share being chiefly confined to buying the straw from the farmers and bringing it home to the women.¹³ One shilling a head was paid for binding wheat straw into bundles for market.¹⁴ In 1813 John Arnold, employed by Mr. Benjamin Kitchener, of King's Walden, who sold for plaiting such of his straw as was suitable for the purpose, was

⁸ Pepys, *Diary*, vii, 64. Pepys also speaks of a certain actress 'like a country maid, with a straw hat on' (*ibid.*). It was not until the 18th century that, we are told, the milkmaid, or chip hat, was rescued for a time from old women and servant girls to adorn the heads of the first fashion. Ben Jonson writes to Lady Mary Wroth:

'He that saw you wear the wheaten hat
Would call you more than Ceres, if not that.'

⁹ Young, *Gen. View of Agric. of Herts.* 32.

¹⁰ *Ibid.* 222.

¹¹ *Ibid.* 223.

¹² *Ibid.*

¹³ Tansley, *Soc. Arts. Trans.* (1860).

¹⁴ Walker, *Gen. View of Agric. of Herts.* 83.

charged with drawing straw for themselves with two others. The custom was for the buyer to draw straw from the sheaf, paying 5s. for a bundle weighing about 60 lb.¹⁵ At a later date Lydia Badricks was charged with making away with 2 score and a half of the value of 2s. 6d.¹⁶ The actual art of plaiting was taught in plaiting schools, of which there was at least one in every village where the industry was established. The school was presided over by an elderly dame, who charged the modest fee of 2d. or 3d. a week for imparting her knowledge to the small scholars, who, after about five weeks' training, could earn, it was said, from 8s. to 14s. a week.¹⁷ The plait, after having been made up into lengths of 20 yards, known as scores, each yard forming one link or coil of plait, was offered for sale in the plait markets which were held in the open streets or market-places of the chief towns of the county. Strict municipal regulations governed the conduct of these markets. In the plait market of Tring, once famous for the industry, sale of plait was restricted, in the reign of Charles II, to the morning hours, the afternoon being reserved for the sale of corn.¹⁸ At Hemel Hempstead, where the plait market was held in Collet's Yard, afterwards the site of the 'King's Arms,' none might buy or sell plait before 7 a.m. from Michaelmas to Lady Day, or before 8 a.m. during the rest of the year. No plait was to be offered for sale on the general market day.¹⁹ The opening of the market was announced to buyers by the ringing of a bell. The purchased plait was not only disposed of locally. Essex village plaiters made use of Hertfordshire cut straw, which they bought in Hitchin market.²⁰

Prior to the invention of the straw splitter, which gave a great impetus to the trade, the straws were laboriously cut with a knife. The informant of a contributor to the *Penny Cyclopædia* (1842) told the writer that his father, Mr. Thomas Simmons, residing about 1785 at Chalfont St. Peter (Bucks.), was amusing himself one evening by cutting pieces of wood, when he made an article upon which he put a straw, and found that it divided it into several pieces. A female who was present asked him to give it to her, observing that if he could not make money of it she could. . . . He was subsequently apprenticed to a blacksmith, and, on visiting his friends, he found them engaged in splitting straws with a penknife. Perceiving that the operation might be much better performed by an apparatus similar to that which he

¹⁵ *Sess. R. (Herts. Co. Rec.)*, ii, 237.

¹⁶ *Ibid.* 410.

¹⁷ Austin, *op. cit.* 17.

¹⁸ *V.C.H. Herts.* ii, 281.

¹⁹ *Borough Archives, Bailiwick Rec.* 1 74-1056, pp. 169, 194, 329.

²⁰ I. Chalkley Gould, *Straw Plaiting: a Lost Essex Industry*, 5.

INDUSTRIES

had made some time before, he then made some machines of iron on the same principle.

Mr. Tansley, in the paper to which reference has previously been made, claims the invention of the splitter for some French prisoners at Yaxley Barracks, near Stilton, in 1803-6, who first made it in bone.

It was about 2 in. long, brought to a point, behind which a set of cutters was arranged in a circle. The point entered the straw pipe separating it into so many equal-sized splints. Some were arranged to cut a straw into four parts, others five, and so on up to nine. This instrument was soon imitated, and being of such surprising agility, numbers were speedily made, and fetched as much as from one to two guineas each. A blacksmith of Dunstable, named Janes, made them in iron, and turned the end downwards at right angles with the stem, the cutters being placed immediately above the point. . . . A few years afterwards, about 1815, others were made like wheels and inserted in a frame, the points projecting in front of each. By this arrangement four or five splitters could be fixed in one frame.

To this invention may be attributed the success which, in after times, has attended the manufacture of straw plait in England.²¹

When straw-plaiting was a thriving industry, north Hertfordshire farmers who laid themselves out for the trade saw to it that their wheat was reaped carefully by hand, as the breaking action of the machine would have ruined the stems.²² In the next process the flags or leaf growths were separated from the straw, which was then cut into equal lengths between the joints, the most usual length employed being about 9 in. The straw was then tied up into bundles^{22a} for the markets, where the plaiters bought it.

The splitting was in the early 19th century done originally by bone 'engines,' but these were afterwards replaced by brass splitters or iron splitters in wooden handles. The earlier bone engines were made from the shank-bone of an ox. The hardest part was sawn into small cubes, and from these the engines were chiselled. In the centre was a sharply-pointed

²¹ Austin, *op. cit.* 16.

²² I. Chalkley Gould, *loc. cit.*

^{22a} Mr. G. E. Bullen states that there has recently been brought to his notice at Redbourn a somewhat elaborate and unusual 'straw sorter.' It consists of a woodwork frame, at the top of which were placed sections of wire gauze with mesh of varying diameter. The several sections were kept separate below by means of pieces of fabric, the compartments thus formed communicating with a removable trough again divided into compartments. Apparently the operator took hold of a bundle of cut straws and started to shake it loosely over the mesh of finest diameter, repeating the operation throughout the whole series of 'sorters' until the bundle was disposed of. In this way the various divisions of the trough became filled with straws of equal diameter.

cone from which, a little below, radiated the 'cogs' or cutting edges. These engines were then fitted into wooden handles, or, as we have already seen, inserted in a frame. Their use was as follows: the plaiter thrust the straw over the cone and pressed it against the edges of the cogs, thus dividing it into as many splints as cogs. The splints now required flattening, and this was effected by wetting them and passing them under a hand-roller or between the rollers of a mill. This latter was made with two rollers of beechwood, the pressure being regulated by a screw above acting on loose chucks, which pressed upon the axle of the upper roller.

The plaiter often held the splints thus prepared in her mouth, and taking them one after another as required rapidly plaited them, fresh splints being added to the plait till some twenty yards had been made. The projecting splint-ends were then cut off, and the plait was again flattened by the mill or simple roller. Occasionally, to produce a whipcord edge to the plait, the upper roller of the mill was made with a slight rebate or groove on one end. When the bleaching²³ was done by the plaiters themselves the process was extremely simple. The bleaching box was of wood a foot or two square with a few bars within at about half the height of the box. On these the plait was laid while a little sulphur was placed beneath on a pan of live charcoal or glowing embers. After two hours' exposure to the fumes the plait could be removed thoroughly bleached and ready for sale.

In 1823 'the small but bustling market town of Redbourn' owed much of its prosperity to the plait trade. From this centre plait was carried to Dunstable, St. Albans and Luton.²⁴ About 1830 Hertfordshire straw was actually sent to Switzerland, where it was plaited and returned to England and there sold, notwithstanding the import duty of 17s. 5d. a lb., for 5s. per lb. less than the plait produced in England.

The population returns of 1831 point to no diminution in the trade. A great number of females were engaged in the industry in Berkhamstead and a number of women and boys in St. Albans.²⁵ In 1861, 603 men and 8,598 women were employed in straw plaiting, 147 men and 1,874 women in hat and bonnet-making.²⁶ Each of the plaiting districts produced a peculiar plait. Thus Hitchin was known for its 'broad twist' and all kinds of medium twist plait, also for 'plain improved,'

²³ Occasionally the bleaching was done before the plaiting.

²⁴ Pigot, *Dict. Herts.* (1823), 360.

²⁵ *Pop. Ret.* 1831, p. 246.

²⁶ Austin, *op. cit.* 8.

A HISTORY OF HERTFORDSHIRE

partly by outside labour. They also buy and finish work already sewn. The outdoor hands mainly do trimming and finishing at their own homes. Gentlemen's hats are the principal articles made at St. Albans, but the small factors, especially at Markyate, sew ladies' hats for manufacturers at Luton, the chief seat of this branch of the trade. Many of the St. Albans manufacturers block and trim a quantity of imported goods. In St. Albans alone over eleven hundred persons are employed in the trade at the height of the season.⁴²

Several of the firms at St. Albans are of old standing.⁴³ The present firm of T. H. Johnson & Sons was founded in 1834 by the late Mr. Thomas Johnson. Other manufacturers then existing in the town were Heywood & Harris, W. Johnson, T. Richardson, G. Slade and J. Morris. Mr. Thomas Johnson first began business in weaving by hand looms, the materials used being cotton, straw and Senneck horsehair (Lima) which were made up into a kind of plait or trimming in 10-yard lengths.

This was employed for making ladies' hats and bonnets. In or about 1836 an American of the name of Smith introduced the Brazilian hat industry to St. Albans. The material used was a kind of palm grass, which had to be washed and cleaned and then bleached or dyed to any required shade, being afterwards reduced and split into various widths for direct plaiting into hats. Other manufacturers to take up this trade were G. Slade, S. West, T. Harris, J. Morris, W. Keightly, J. Webdale and Thomas Johnson; but, as already mentioned, the French hat makers produced finer goods to compete with the St. Albans manufacturers, and thus obtained the bulk of their trade of that kind. Hand sewing was largely superseded by the invention, about 1875, of a machine for stitching hats by Mr. Bland, of Luton. It was called the 'Fifteen Guinea machine.' Further improvements have since been made, and the best stitching machine in the market is that known as the 'Thirty-two Guinea machine.'

PAPER-MAKING

The chief manufacturing industry with the history of which Hertfordshire has been prominently associated in modern times is paper-making. The manufacture of paper was probably introduced into Europe from the East by four routes: in the 6th century through Greece, and early in the 7th century through Italy from Arab sources, by the Moors to Spain in the 8th century and through Venice into Germany in the 9th; but it is certain that the manufacture of white paper was not established in England until almost the end of the 15th century, though possibly the coarser grades of paper might have been made in this country at a somewhat earlier date.

The first English paper-maker of whom we have any definite record was John Tate the younger, son of Sir John Tate, Mayor of London in 1496, who had a mill at Hertford, probably 'Sele Mill.' Of this mill no record now remains beyond the names of 'Paper Mill Ditch' and 'Meadow,' applied to a channel and field not far from the old Hertford water-works.

That the making of fine paper in England was considered a matter of national importance is shown by the fact that in the household book of Henry VII appear the following two entries. On 25 May 1498, when staying at Hertford Castle, the king visited Tate's mill, and an item appears in the accounts, 'For a rewarde geven at the Paper Mylne, 16s. 8d.'; and in the

following year a somewhat similar entry, 'Geven a rewarde to Tate of the Mylne, 6s. 8d.'

In an edition of the *De Proprietatibus Rerum* of Bartholomaeus Anglicus, printed by Wynkyn de Worde about 1495, occur the following words: 'And John Tate the younger Ioye mote he broke | whiche late hathe in Englonde doo makes this paper thynne | that now in our Englysshe this boke is prynted inne.' Tate's paper was also used for an edition of Chaucer in 1498, and for the 'Golden Legend' in 1498, also for a large bull of Alexander VI of 1494, now in the Lambeth Library, and for the supplement to it of 1495, now in the British Museum and the Bodleian Library.

The water-mark Tate used was a two-line circle, the outer ring just over $1\frac{1}{4}$ in. in diameter, and the inner, which is slightly oval, $1\frac{1}{8}$ in. to $1\frac{3}{8}$ in. containing an eight-pointed star, possibly representing St. Katherine's wheel. The illustration of this mark is taken from a blank leaf after the eleventh book of the *De Proprietatibus Rerum*. This early Hertford paper-mill had a short life, and it is

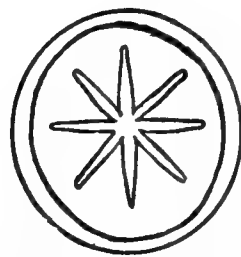

WATER-MARK OF JOHN TATE

⁴² Inform. from Mr. G. E. Bullen.

⁴³ Inform. from Mr. T. H. Johnson and Mr. G. E. Bullen.

INDUSTRIES

references to the enterprise. To Thomas Bolls he left 'as moche whit paper or other paper as shal extende to the somme of 26s. 8d. . . . owte of my paper myll at Hartford.' But it is perhaps significant that, while the bulk of his estates in Essex and Hertfordshire went to the eldest son, the executors were directed to sell the mill and its appurtenances 'to moste advantage. In itself this direction is not conclusive as to the commercial failure of the business, but in a *Discourse of the Common Weal of this Realm of England*, published in 1549, a distinct statement is made that an English adventurer in paper-making, who, though not named, must certainly have been Tate, had given up owing to foreign competition.¹ Thus there seems to be no doubt that to Hertfordshire belongs the honour of having possessed the first English paper-mill making white paper. But beyond this, the first mill making paper by machinery was also established in the county.

In the year 1798 Louis Robert, a workman employed in the large mills of François Didot, at Essonne, in France, devised a plan for making paper in endless webs, and, having demonstrated his idea experimentally, he obtained a patent in 1799 for fifteen years; owing, however, to the disturbed state of the country the invention was not then worked in France. In 1801 John Gamble patented Robert's invention for him in England, and, after some improvements on it had been patented, Mr. Bryan Donkin completed a machine at the end of 1803. Messrs. Henry & Sealy Fourdrinier, who had bought an interest in the English patents, got this machine to work at Frogmore Mill, on the River Gade, near Boxmoor, in the year 1804.

Fourdrinier's machine essentially consisted of an endless web of woven wire cloth, moving forward slowly over a series of small rollers in a horizontal plane, the paper pulp flowing on to one end of the level part of the wire, water being drained off from it as the wire moved forward, and the partially-drained pulp, after consolidation between two rollers, being drawn away from the surface of the wire as a continuous web of paper. Owing to defects of detail, want of experience, and the many difficulties incidental to the establishment of a new industry, it was several years before this machine proved successful in practice, though its principle is the one still employed by nearly all paper manufacturers in the world. In the only rival machine the paper web is formed on a revolving cylinder covered with wire cloth. This machine, which

was invented by Mr. John Dickinson, of Nash Mills in this county, and patented in 1809, was originally devised to obviate some of the difficulties experienced with Robert's machine, or, as it is more commonly called, Fourdrinier's machine, and Mr. Dickinson succeeded in making good saleable paper on his machine while Messrs. Fourdrinier were being gradually ruined in trying to perfect that of Robert. The cylinder machine is still in use for certain purposes, more especially for making mill-boards and thick composite papers consisting of several webs of paper superimposed on one another in the course of manufacture.

The result of the introduction of paper-making machinery has been the concentration of manufacture in a few large mills and the closing down of many small mills scattered over the country; and, although at one time there were probably at least twenty paper-mills² working in Hertfordshire, there are at the present moment only three firms actually at work. In spite of this large numerical reduction the quantity of paper made in the county is now larger than it ever was. The total weight of paper made in England in 1721 was about 3,600 tons. In 1800 this had increased to 8,000 tons, and the quantity now made in Hertfordshire alone is about 20,000 tons annually.

There is one other development of paper-making in this country which is of some historical interest. On the adoption of Rowland Hill's suggestion of the penny post the Government on 30 April 1840 issued three varieties of stamps—namely, stamped covers, stamped envelopes, and adhesive stamps. The first two of these were the Mulready envelopes and covers, which were printed on a special safety paper, in the body of which very thin silk threads were imbedded at fixed intervals. This paper was invented by Mr. John Dickinson, and was all made by him at Apsley Mills, near Hemel Hempstead. The adhesive stamps were the black *1d.* stamps, practically identical with the red penny stamp in use during the greater part of the reign of the late Queen Victoria, except that they were not perforated. The Mulready design, which was drawn by William Mulready, R.A., and covered the whole face of the envelope, met with a great deal of criticism and ridicule, and was abandoned in the year 1841, but Apsley Mill continued to supply the Government with silk-thread paper for the

¹ These new facts are brought forward by Mr. Rhys Jenkins in his article 'Early Attempts at Paper-making in England,' in *Library Assoc. Rec.* ii (2), 481 et seq.

² Besides the localities mentioned in the text, Harpenden, Rickmansworth, Standon and Sarratt, all possessed paper-mills in the 18th or early 19th century. Two Waters, Sarratt, Poles Bridge, Mill End, Home Park, Apsley, Loudwater and Rickmansworth mills have all ceased working within the memory of the writer.

A HISTORY OF HERTFORDSHIRE

embossed envelopes and wrappers until the year 1860, and also for the octagonal 1s. stamp first issued in 1847 and the 10d. stamp issued in 1848.

Among the paper-mills now working in Hertfordshire are the Croxley Mills and Nash Mills, of John Dickinson & Co., Ltd.; the Hamper Mills, Watford, belonging to Mr. Joseph Gutterage Smith; and the Frogmore Mills, of the British Paper Co., Ltd., at Apsley End.

Apsley Mill, converted from a corn-mill in the 18th century, was bought by Mr. Dickinson in 1809, and supplied the paper for cannon cartridges used in the Peninsula and at Waterloo. In 1888 paper-making at Apsley was discontinued. Cards were first made at Apsley about 1831 and envelopes some years later, but the manufacture has since been enormously extended, the old mill having been reconstructed and enlarged to meet modern requirements.³ In 1911, 2,000 persons were employed at Apsley Mill, and the envelope and card factories here are now the largest in Great Britain.

Croxley Mill, built by Mr. Dickinson, was opened as a paper-mill in 1830. In 1886 it was decided⁴ that this mill should prepare all the materials and make all the paper formerly made at Two Waters, Frogmore, Apsley, Home Park, Batchworth, and the Manchester Mill. Very comprehensive schemes of enlargement were thereby rendered necessary, and constant

improvements in machinery and methods have since kept the mill well up to date.

In 1811 the Nash Mills, Hemel Hempstead, were bought by Mr. Dickinson from Messrs. A. Blackwell and E. Jones, and only two years afterwards suffered serious damage from fire. Here in 1830 Mr. Dickinson set up his machine for making fine plate and duplex papers. This mill was practically rebuilt in 1879, and here in 1888 one of the paper machines was first driven by an electric motor. The mill is specially adapted for producing composite and duplex papers and can turn out some 100 tons a week.

Home Park Mill was built by Mr. Dickinson in 1825, and later much enlarged. In 1878 the first colouring machine was put up, paper-staining having been done here previously by hand. Since 1888 no paper has been made here, and in 1890 a large colouring mill was built and turbines were installed in place of the old water-wheels. Hand colourers are still employed for special work, but the mill is fitted with improved colouring machines for the production of chromo, enamelled, coloured, and art papers and cards.⁵

Owing to the favourable position of the Hertfordshire mills, water carriage is still largely employed, although the main line of the London and North Western railway passes close to three of the mills and there is a siding into Croxley Mills.

PRINTING

Modern research is responsible for the overthrow of many time-honoured beliefs. Is it destined to rob St. Albans of the honour of being one of the first places in England in which the art of printing was exercised? There exist at the present time copies of eight works which, from their typographical resemblance or the statement in their colophons, claim to have been printed at St. Albans, in Hertfordshire, between the years 1479 and 1486. In none of them is the name of the printer mentioned, and the only clue to his identity that has ever been discovered is a statement made by Wynkyn de Worde, William Caxton's successor, in the colophon to the 1497 edition of the *Chronicles of England*, that the work was printed in the first place by 'one sometyme scolemayster of St. Albons.' This statement would seem plain enough, and the Grammar School at St. Albans, which, according to the latest historian, Mr. A. F. Leach, had been established since the 9th century,¹ has always been taken as the home

of this printing press, a belief which has been further strengthened by the statement found in the colophons to some of these books that they were printed 'apud villā Sancti Albani.'

It is true that no contemporary record exists of any printing having been carried on in the St. Albans Grammar School. Neither the registers of Abbot Wallingford nor those of his successor² mention that the schoolmaster was printing books; but neither is there any contemporary mention of Caxton or his work at Westminster, except such as appear in the rent rolls of the abbey, for the rent of the Red Pale. Since Wynkyn de Worde's day nothing has come to light to reveal the name of the schoolmaster printer at St. Albans, and Mr. Leach has recently expressed the opinion that it will never be discovered until one of the account rolls of the almoner of the abbey for the years 1480-6 shall be found.

And now, to deepen the mystery and thicken the shadows that surround the St. Albans

³ L. Evans, *The Firm of John Dickinson & Co. Ltd.*

⁴o.

⁴ Ibid. 25. ¹ *V.C.H. Herts.* ii, 47.

⁵ L. Evans, *The Firm of John Dickinson & Co. Ltd.* 44.

² *Reg. Abbat. Joh. W'ethamstede* (Rolls Ser.), ii, 140-291; B.M. Arundel MSS. 34.

INDUSTRIES

printer, Dr. Edward Scott has found amongst the muniments at Westminster Abbey a deed or deeds relating to a manor there called 'Little St. Albans,' which, he says, stood on the green outside the chapter-house, between it and the present House of Lords, and which was occupied by one Otnel Fullē (presumably Fuller), the 'magister scolarium' of the Westminster School.³ Mr. Scott was unfortunately unable to lay his hand on these documents when the writer visited him at the muniment room with the object of examining them, but he produced two deeds—one⁴ an account by John Esteney, warden of the 'new work' at Westminster for the year 1482-3, in which mention is made of a gift of 10s. from 'Otnel Fullē late master of the scholars at the Almonry'; the other⁵ undated, but assigned to the year 1509, an account of the collectors of the rents of Westminster Abbey, which mentions the Earl of Shrewsbury as renting two tenements in 'seynt albonys.' This last would seem to indicate that the manor was known to the inhabitants of Westminster as 'St. Albans,' rather than 'Little St. Albans,' and assuming Dr. Scott's statement to be correct, that it was at one time occupied by Otnel Fullē, the 'magister scolarium,' it would exactly fit Wynkyn de Worde's statement, 'sometyme scolemayster of St. Albans.'

The discovery made by Dr. Scott is an attractive one. The arrival of Caxton with a printing press at Westminster must have aroused much curiosity amongst the clergy and others connected with the abbey, and we can readily believe that amongst the earliest visitors to the new printing office at the Red Pale would be the 'magister scolarium.' It is quite possible that a friendship may have sprung up between the two men, and that Otnel Fullē may have been the 'friend and gossip' at whose instigation, as Caxton tells us himself, he printed the *Boethius*.

But, beyond what has been stated, nothing whatever is known about Otnel Fullē or Fuller. There is no evidence that he ever printed anything or that he ever spoke a word to Caxton in his life. It is true that we are in the same case as regards the Hertfordshire schoolmaster; before attempting to decide between the claims of these two shadowy claimants we had better look at the books.

Of the eight works printed at the St. Albans press six were of a scholastic character. The first to appear is believed to have been the *Elegancie* of Augustine Dactus, a small quarto of thirty-two leaves, without date, with the colophon, 'Impressum fuit opus hac apud Sc̄m

Albanū.' A facsimile of this book has recently been published by the University Press of Cambridge, under the editorship of Mr. F. Jenkinson, from the unique copy in the University Library.⁶

The type is quite remarkable, a small Gothic letter, unlike anything in use either at Westminster or Oxford at that time, and noticeable not only from the variety of sorts, but for the regularity of the casting and the neatness of the press work, which makes it difficult to believe that it was the work of a beginner in the art of printing. Mr. E. G. Duff, in his *Early English Printing*,⁷ expresses the opinion that this type was modelled on Caxton's, but there is no evidence on the point. No other book was printed with it, and it was never used again except for signatures; hence the belief that it was the first type used by this printer about the year 1479.

Two books are found with the date 1480, each in a different fount of type. The first is a quarto without title-page or pagination, but having the colophon, 'Impressum fuit hoc presens opus Rethorice facultatis, apud villā sancti Albani. Anno domini M.CCCCL.XXX.'

The type, which may be described as Type 2 of the St. Albans press, is a larger and more striking letter than its predecessor. Mr. Duff⁸ rightly describes it as bearing a 'superficial resemblance' to Caxton's Type 2*. It was this 'superficial resemblance' that led Mr. H. G. Allnutt, when describing the work of this press,⁹ to say: 'The type used in printing the Saone in 1480 bears so remarkable a likeness to a fount used by Caxton about the same time, and called by Mr. Blades Type 2*, that there may well have been some connection between the two men, and why, indeed, may not the schoolmaster have learned his art in Caxton's office?' But 'superficial' is entirely the right word to describe the resemblance that strikes the eye between this type and Caxton's Type 2*. A close analysis shows first that it is smaller in body than Type 2*, measuring only 122 mm. to twenty lines of text, as against 134 mm. to twenty lines in Caxton's type. It was also more clumsy and irregular than Type 2*, it reveals the presence of a lower case 'v,' which is not found in Type 2*, and is moreover not found in any of Caxton's books, while the looped letters, so marked a feature of Types 2 and 2*, are not met with in the Saone. This type may have been modelled on Caxton's, or it may have been some of the type from his

⁶ *A series of photogravure facsimiles of rare 15th-cent. books printed in Engl. now in the University at Cambridge* (ed. F. J. H. Jenkinson, 1905).

⁷ E. G. Duff, *Early English Printing* (1896).

⁸ Op. cit.

⁹ See also Blades, *Life of Caxton*, ii, 75.

³ Letter of Dr. Edward Scott to the writer.

⁴ No. 23558.

⁵ No. 22872.

A HISTORY OF HERTFORDSHIRE

office trimmed up or recast. It is a curious thing that Caxton did actually print this same work in Type 2* between July 1478 and the early part of 1480.

The second book of the year 1480 was Albertus, *Liber Modorum Significandi*, only known from a copy in the Bibliothèque Nationale. It was printed in a third type of Gothic, slightly smaller than that in which the *Rethorica* was printed, making but ninety mm. to twenty lines, and noticeable from the large number of contractions with which it abounds, and in which respect it somewhat resembles the type of Lettou and Machlinia, although it was clearly cut by the same hand as the second fount. Three other books were printed in this type. Two of these were issued in 1481. One is Joannes Canonicus, *In Aristotelis Physica*, a folio printed in double columns, the handsomest book that came from this press. One leaf said to belong to a copy of this book is now in the Herts. County Museum, and has capitals rubricated (by hand apparently), also the margin of the paper with the numbers of the pages written in ink. These were probably added at a later date, as the perfect copy in the Bodleian has none of these features. The second work is *Exempla sacra scripture*, a quarto without pagination or catchwords, and having the colophon, 'Im̄psaq3 aṽd uilla Sancti Albani. Anno dñi m° cccc° lxxxi°,' a copy of which is preserved in the library of the Middle Temple. The third book, Andreas Antoninus, *Super Logica Aristotelis*, a quarto, appeared in 1482, and is only known from fragments.

The last two books that came from the St. Albans press were both in English, and, apart from their printing, have other connexions with St. Albans, which add largely to their interest. The exact date of the appearance of *The Chronicles of England* is unknown, but in the opening lines of the prologue (sig. a ij) the author says: 'Therfoor i the yeer of our lorde M. iiij° lxxxiiij, And in the xxiiij yeer of the regne of kyng Edward the fourth at Saynt Albons so that all men may knaw the actys naemly of our nobull kyngys of Englonde is cōpylit together thys book.' So that it could not have been printed earlier than that year. But, although the compiler claimed this as an entirely new work of his own, the only part that was original appears to have been the general history of the world from the time of Adam until the days of Brute, the first twenty-six pages of the book. From that point down to the year 1460 the text followed was the same as that used by Caxton when printing the earlier edition of 1480. The book has two other peculiarities not found in previous issues from this press, the use of red ink, and the signing of all the leaves of every sheet, a thing rarely met with, and arguing the work of a

novice. The type used to print this book was mainly that found in the *Rethorica*, but other sorts were introduced, notably a fount of English black letter, which all bibliographers have accepted as being Caxton's Type 3. If they are right, a point that seems open to considerable argument, it forms another link between the St. Albans printer and the Westminster press that has to be accounted for. *The Chronicles*, in spite of the clumsy and uneven casting of the type, was fairly well printed.

The second English book, and the last book as far as is known, that came from this press was the *Books of Hawking, Hunting, and also of Coat Armour*s (now popularly known as the *Book of St. Albans*), which bears the colophon: 'Here in thys boke afore ar contenyt the bokes of haukyng and huntyng with other plesures dyurse as in the boke apperis and also of Cootarmuris a nobull werke. And here now endyth the boke of blasynge of armys translaty and compylt togedyr at Seynt Albons, the yere from thincarnation of our Lorde Jhu Crist. M.CCCC.lxxxvi.' On the last page of text are the words Sanctus Albanus, below the arms of St. Albans, in red, as in the *Chronicles*. Indeed, with the exception that the type is more worn and the presswork worse than in any other book from this press, the two English books agree typographically in all particulars. Not only do they agree typographically, but in closely similar language we are informed that they were 'compiled' at St. Albans. Of the *Chronicles of England* it is said that 'in the xxiiij yeer of the regne of Kyng Edward the fourth at Saynt Albons so that all men may know the actes naemly of our nobull Kynges of England is cōpylyt together thys book.' On the colophon to the *Books of Hawking, Hunting, and also of Coat Armour*s, we read, as we have just seen, that last section, 'the boke of blasynge of armys' was 'translatyt and compylt togedyr at Seynt Albons' in 1486.

Now the name of a strip of land between Westminster Abbey and the House of Lords might be given as an address by a printer without further explanation, though we should certainly have expected some additional help towards localizing it, but to use such a curt and misleading description to indicate the place of literary composition would be much more extraordinary. It is true that a prophecy that Henry IV should die at Jerusalem was supposed to be fulfilled by his dying in the Jerusalem Chamber at Westminster, but the methods of interpretation open to prophets and to bibliographers are not the same. Thus the statements that these two books were compiled at St. Albans must be taken to refer to St. Albans in Hertfordshire. This carries with it the reference to St. Albans as the place of printing,

INDUSTRIES

since it is impossible to conceive of the name being used in two different meanings by the same printer, and thus, despite the attractiveness of Dr. Scott's theory, the St. Albans press must still be credited to Hertfordshire.

The second St. Albans press was that of John Hertford, Harford, Herford or Hereford. In the year 1534 appeared a small quarto with the title: 'Here begynnethe ye glorious lyfe and passion of Seint Albon, prothomartyr of Englande, and also the lyfe and passion of Saint Amphabel, whiche conuerted saint Albon to the fayth of Christe,' of which John Lydgate was the author. This title is above a woodcut of a figure holding a cross, and on either side are two border pieces which are recognized as having formed part of the plant of a London printer, possibly Wynkyn de Worde. The type is ordinary black letter, not new, but in very fair condition. Neither printer's name nor place occurs on it. This book was printed at the request of Robert Cotton, abbot of the monastery, and it would seem as if Herford's press was situated within the abbey precincts.

His next venture, 'The confutacyon of the first parte of Frythes boke . . . put forth by John Gwnneth, clerke, 1536,' 8vo, was the work of one of the monks of the abbey, who in the previous year had signed a petition to Sir Francis Brian on the state of the monastery.¹⁰ This again has no printer's name, but has at the end a device containing the letters R.S. intertwined, standing no doubt for his patron Richard Stevenage, who was at that time chamberer of the abbey, and was created abbot on the deprivation of Robert Cotton in 1538.

Of the three books printed by Herford in that year two were expressly printed for Richard Stevenage. These were, 'A Godlye disputation between Justus and Peccator and Senex and Juvenis,' written by Dionysius de Leeuwis, and 'An epistle agaynste the enemies of poor people,' both octavos, of which no copies are now known. The title-page of the first is among the Bagford MSS. and bears the imprint: 'Imprinted at St. Albans by me Jo. Hereford for M. Richard Stevenage.'¹¹ The third work bearing the date 1538 was 'The Rule of an honest Life,' written by Martin, Bishop of Dumience.

The reign of Richard Stevenage as abbot was a short one, for on 5 December 1539 he delivered the abbey over to Henry the Eighth's commissioners. Shortly before that event, on 12 October, Stevenage wrote to Cromwell, and in this letter occurs the following passage: 'Sent John Pryntare to London with Harry Pepwell, Bonere [i.e. Bonham] and Tabbe of Powles Churchyard, stationers, to order him at

your pleasure. Never heard of the little book of detestable heresies till the stationers shewed it me.'¹² The John Pryntare here referred to can be none other than John Herford, and the book which caused the trouble is probably one entitled 'A very declaration of the bond and free wyll of man. The obedyence of the gospell, and what the very gospell meneth.' The book has no name of printer or date, but only the name of the place. A copy of it is in the John Rylands library at Manchester.¹³ In all, seven books were printed at this second St. Albans press. What punishment was inflicted on Herford is unknown, but the suppression of the abbey prevented him from returning to St. Albans, and he accordingly set up in London in 1544, where he remained until his death in 1548.

After the cessation of this second St. Albans press an interval of nearly 130 years elapses before we again meet with printing in Hertfordshire. The reason is to be found in the successive Acts and decrees which, beginning with the Star Chamber decree of 1583 and continuing until the close of the 17th century, forbade any printer to set up a press in any part of England except London and the two Universities. The city of York was added to the privileged places by an Act of the Commonwealth passed in 1649, and during the period of the Civil War printing was carried on in a few towns such as Bristol, Exeter, Shrewsbury and York, but this was done by the representative of the King's Printer and by Royal Command. After the fire of London the repressive Acts fell into abeyance, and very slowly throughout the 18th century printing became general.

The following account of the third Hertfordshire press, that of Stephen Austin of Hertford, from which has developed the well-known firm of Stephen Austin & Sons, Ltd., Oriental printers, is from notes kindly supplied by the late Mr. Vernon Austin, the descendant of Stephen Austin, and Mr. Harrison, the managing director. The firm was founded in 1768 by Stephen Austin, who was apprenticed to George Kearsley, of Ludgate Hill, London, the printer and publisher of the newspaper known as the *North Briton*, which was started by John Wilkes, M.P. for Aylesbury, and Alderman of London, in opposition to the administration of Lord Bute, an opposition which was continued against the successive representatives of his policy, and which eventually culminated in the celebrated letters of 'Junius.' In the notorious No. 45 of the *North Briton*, published in April 1763, the speech of King George III, with which the session of Parliament had been closed, was severely criticized to the extent of asserting that the ministry had made the king

¹⁰ *L. and P. Hen. VIII*, ix, 1155.

¹¹ Ames, *Typographical Antiq.* (ed. Herbert), 1436.

¹² *L. and P. Hen. VIII*, xiv (2), 315.

¹³ Duff, *Century*, 70.

A HISTORY OF HERTFORDSHIRE

utter falsehood, and thereupon, under a 'general warrant' issued by Lord Halifax, Wilkes and Kearsley were arrested and lodged in the Tower, charged with a libel on the king; but on being brought before the Lord Chief Justice on a writ of habeas-corpus their arrest was declared illegal and they were discharged, and each of them subsequently recovered damages against Lord Halifax for illegal arrest and seizure of papers. Stephen Austin was on the premises when the officers came to make Kearsley's arrest, and while they were knocking for admission he hurried to the office and, locking the door, gathered the copy which was being set for No. 46, thrust it into his pocket, upsetting the type that was on the 'galleys,' and putting his foot through the 'formes' in 'chase,' he got out of the window and on the roof just before an entrance was effected by breaking open the door. Subsequently, during Kearsley's detention in the Tower, he carried on the business, and for some time after his discharge remained with him, until he came to Hertford and commenced business on his own account as a printer and schoolmaster in 1768. In 1772 he started a paper called the *Hartford Mercury* (some of the earliest copies of which are in the possession of his descendants), published weekly at the price of 2½d. Subsequently the paper developed into the *Hartford, Bedford and Huntingdon Mercury*, and being the only newspaper published in those counties was widely read. The sparseness of the population, however, together with the difficulties of locomotion and the expense of bringing out a sheet at that time, proved insurmountable obstacles to its financial success, and after some years the venture was discontinued.

Stephen Austin, however, continued to carry on the business of a printer, and in due time was joined by his son, another Stephen Austin, born in 1776, who ultimately succeeded to the business, and from whom it passed to his son Stephen, the father of Mr. Vernon Austin.

Mr. Vernon Austin's father and grandfather were the appointed printers and booksellers to the East India Company's College, the work of which, while Haileybury College was being built, was carried on at Hertford Castle. This position was retained until the Company was dissolved in 1858; and it was under the auspices of the authorities of that institution that the printing and publishing at Hertford of works in various Oriental languages was commenced. Up to that time great difficulty had been experienced in procuring the different Oriental books required by the students in their studies; those that were obtainable were only to be had at great cost, while the type used was so bad and the paper of such indifferent quality that the books were oftentimes almost illegible. It was somewhat of a revolution, therefore, when

The Hitopadesa was printed with new Sanscrit type at Hertford in 1847, as at that date there were not more than one or two Oriental printers in England, and thenceforward during successive years a great number of books printed in Sanscrit, Bengali, Arabic, Persian, Pushto, Hindustani, Hindi, Hebrew, and other Eastern languages, as well as in Greek, Latin, German and French, were issued from the Hertford Press of Stephen Austin, the name by which the firm was known at that period. One of the best examples of its work at that time is to be seen in a sumptuous edition of the Indian drama *Sakoontala, or the Lost Ring*, translated by the Rev. Monier Williams, and published in 1855. Each page and every woodcut was surrounded by decorative borders taken from MSS. in the British Museum and the library of the East India Company, designed by T. Sulman, jun., and engraved by George Meason, and printed in gold and colours, while the typography and press work were of the highest order. In his introduction the editor pointed out that the press of Stephen Austin of Hertford had issued some of the most perfect specimens of decorative Oriental printing that this country had ever produced. In short, the firm acquired a world-wide reputation for Oriental printing, and many of the finest specimens of Oriental typography now extant bear that name. The skill and taste displayed in these productions were acknowledged by the presentation of gold medals by the late Queen Victoria and the Empress of the French, by the award of medals of the first class at the International Exhibitions held in London and Paris, &c., and by testimonials from many of the most eminent Oriental scholars of Europe and India; and in the year 1883 the Congrès International des Orientalistes presented their diploma for services rendered to Oriental literature.

In the year 1834 Mr. Austin, at the request of the leading members of the Whig party in the county, including Lord Dacre, Mr. Rowland Alston, Mr. H. G. Ward, M.P. (afterwards Sir Henry Ward, Governor of Madras), and others who were stirred to action by the circumstances which shortly afterwards led to William IV abruptly dismissing Lord Melbourne's ministry—started the journal which is now known as *The Hertfordshire Mercury*. At that time it was called *The Reformer*, and in the early days of its existence it numbered amongst the contributors to its columns Mr. H. G. Ward, M.P., Sir Culling Eardley Smith, bart., and many other persons distinguished in politics, literature and art, including Dr. Arnold, of Rugby, whose letters to the Editor, signed 'F. H.' during the years 1837-40, were afterwards collected and published in the *Miscellaneous Works of Thomas Arnold, D.D.*, by Dean Stanley.

INDUSTRIES

For upwards of fifty years—until his retirement in 1884 from active business pursuits—Mr. Austin continued to carry on this journal, advocating through good and ill report the established principles of Liberalism, and rendering loyal support to the Governments of Lord Melbourne, Lord Aberdeen, Lord Russell, Lord Palmerston and Mr. Gladstone, to the last named of whom he was an unwavering adherent up to the last hours of his life.

In 1854 the present premises were commenced and were added to in 1909. This was the third and last move of the business.

In January 1871 Stephen Austin took his two sons, Stephen and Vernon, into partnership. Stephen Austin, sen., continued to take a very active part in the affairs of the business until he retired. Even then he would not let a copy of the newspaper he founded go to press without seeing the final proofs. His energies in this respect made *The Hertfordshire Mercury* the respected paper it is. The two sons worked in partnership until 4 September 1903, when the elder of the brothers died.

On 10 June of the following year the business was turned into a limited company, and Vernon Austin was made governing director. During the long period the business has been in existence it has always kept abreast with the times. Old machinery has been replaced again and again to keep pace with the other improvements, so as to be able to produce and keep up the splendid record of good printing.

Until 1906 the firm had in its possession one of the old original steam flat-bed platen printing presses. These machines until about twenty years ago were considered to produce the finest work. Since that time the cylinder machines in their many forms have been so perfected that they supersede them both in speed (such a necessary quality to-day) and good printing. One veteran machine is still on the premises and also in use, and good use; this is the hand-press on which *The Hertfordshire Mercury* was originally printed.

In 1905, feeling the need of assistance and wishing to enjoy more leisure, Mr. Vernon Austin turned to his old friend, Mr. Edgar Harrison, of the well-known firm of Harrison & Sons, of St. Martin's Lane, London, with the result that the only son of this gentleman came down in 1906 with the twofold object of increasing his knowledge of the art of printing—which he had acquired in the first instance in the country where printing was invented—and giving his personal assistance to Mr. Austin.

In November 1906 Mr. Victor Harrison became a recognized member of the firm. Owing to Mr. Harrison's extensive knowledge of machinery, Mr. Austin placed in his hands entirely the installation of the present new and up-to-date plant, which is now keeping

up the firm's untarnished reputation of always being abreast with the times. In 1909 Mr. Vernon Austin decided to place the active management of the business in the hands of his old friend's son, and appointed him managing director. This is how the old-established business stands to-day, still pursuing its increasingly prosperous career.

In addition to the press of Stephen Austin at Hertford there were a few other printers at work in different parts of the county during the latter part of the 18th century. In 1778 a printer at Cheshunt, named T. Baldwin, printed an auction hand-bill by John Parnell for 1 January 1779,¹⁴ a copy of which is in the Bodleian. In 1793 the Rev. Nathaniel May's *Sermons on the History of Joseph*, preached by him in the parish churches of Hemel Hempstead and Great Gaddesden, were printed for him by William McDowall, a printer at Berkhamstead, in a small octavo form. Copies of these *Sermons* are in the British Museum and Bodleian.¹⁵ In 1800 a printer at Hitchin, named J. Bedford, printed *Regulations for a Review at Hatfield*, presumably a broadside.¹⁶

Coming to the 19th century, the first press that calls for notice is that of Richard Gibbs, sen., of St. Albans, who in 1826 obtained a licence under the old Act to prevent sedition to set up a press in the town. This licence runs as follows:—

St. Albans. Story C.P. I John Samuel Story, Clerk of the Peace for the Borough of Saint Alban, in the County of Hertford, do hereby certify that Richard Gibbs of the said Borough of St. Albans hath delivered unto me a notice in writing appearing to be signed by him and attested by George Lawson as witness to his signing the same, that he the said Richard Gibbs hath a Printing Press and types, which he proposes to use for printing within the Borough of St. Albans, and which he has required to be entered pursuant to an Act passed in the thirty-ninth year of his late majesty's reign intituled, an Act for the more effective suppression of societies established for seditious and treasonable purposes, and for better preventing treasonable and seditious practices. Witness my hand this twentieth day of April 1826. Story C.P.

There was another small printer in the place, named William Langley, of whom, however, nothing is known. Both he and Richard Gibbs the elder carried on business in the High Street. Richard Gibbs's first printing rooms were in a passage, now disappeared, off the High Street, and he used as an office the little shop attached to the Clock Tower, which was removed when the tower was restored about 1858. In old prints of the period the name 'Gibbs' appears on the building, but it is believed that the real

¹⁴ W. H. Allnutt, *Library*, July 1901, p. 250.

¹⁵ *Ibid.* 256.

¹⁶ *Ibid.* 259.

A HISTORY OF HERTFORDSHIRE

tenant was George Washington Gibbs, the printer's brother. Subsequently Richard Gibbs took the shop, No. 21 High Street, an old gabled house now pulled down. Here he carried on the business as a printer and bookseller. Soon after the new Town Hall was built Richard Gibbs removed his business into that part of the old Moot Hall situated at the corner of Market Place and Dagnall Street. This historic building is still a part of the firm's premises, and was purchased from Samuel Crowley, grocer, on 16 December 1837. In 1855 Richard Gibbs the younger succeeded his father in the proprietorship of the business, and on 7 July of that year he printed with his own hand the first copy of the *St. Albans Times*, subsequently called *The Herts Advertiser and St. Albans Times*, which has had a prosperous existence ever since. By a happy coincidence he assisted in printing, on very different machinery, the Jubilee number of the paper on 1 July 1905. Richard Gibbs the younger died in January 1910 at the age of seventy-six, and was succeeded by his son Mr. A. E. Gibbs, who has kindly supplied the information given above. The firm is now Gibbs & Bamforth, Ltd.

Printing is now the chief industry of St. Albans, in that more hands are employed in it than in any other business. The Salvation Army have large works there, and among other firms are Smith's Agency, Dangerfield & Co., Taylor & Co. and several smaller concerns. During the life of the *Herts Advertiser* several other papers have been started: *The St. Albans Dial*, *The St. Albans Illustrated Telegraph*, *The*

St. Albans Herald, not printed in St. Albans, but sold in Market Place, *The County Chronicle*, *The St. Albans Reporter*, *The Herts Standard* and *The Hertfordshire Post*.

Two large firms, Messrs. J. M. Dent & Sons and Messrs. W. H. Smith & Son, have during the present century started printing works at Letchworth. Messrs. W. H. Smith & Son's bookbinding workshops were originally established near Drury Lane in 1904, and Mr. Douglas Cockerell, the distinguished pupil of Mr. Cobden Sanderson, was appointed controller. As the premises in London proved too small new workshops were built at Letchworth, and opened in October 1907. Every kind of bookbinding is done, from simple wrapping in paper covers to costly leather bindings for valuable manuscripts and printed books, about 150 men, women and girls being employed in the workshops. The Arden Press had its origin in the private press established by a Benedictine monk at Stratford-on-Avon about the year 1880. It was then called St. Gregory's Press. A few years later the Press was acquired by Mr. Alfred Newdigate, who moved it to Leamington. In 1904 its name was changed to the Arden Press, and the business was formed into a limited liability company, which Mr. Alfred Newdigate and his son controlled. In 1907 the Press was moved to Letchworth to occupy the new premises built for it by Messrs. W. H. Smith & Son, who purchased the business from the company the following year. About 120 persons are employed, chiefly on fine book and commercial printing.

POTTERY, TILES AND BRICKS

The presence in Hertfordshire of extensive deposits of a suitable clay has resulted in the establishment of the manufacture of pottery and the allied products, tiles and bricks, as one of the most important county industries, and almost the only one with a continuous history, or at least a continuous existence, from Roman times to the present day. That pottery of a crude type, but probably of local manufacture, was produced in pre-Roman times appears to be indicated by the finding of numerous fragments, generally classified as 'Early British' in various parts of the county. Roman pottery kilns have been found at Radlett and also at Aldenham. Details of these discoveries are given in the section on Roman remains, and it is here sufficient to note that the kilns were of the usual type, consisting of a more or less circular pit containing a mushroom-shaped pedestal on which the clay vessels were piled in layers to bake. The heat from the furnace in the base of the pit reached the vessels through

and round the edges of the pedestal, and the smoke escaped through a central vent in the clay dome, built up anew at every firing, over the kiln. The Victoria Playing Fields, St. Albans, is said to be the site of the Roman brickfields which supplied Verulamium with its bricks and tiles. These clay-pits were possibly in use before the existing pre-Conquest earthworks at Kingsbury were thrown up, and washed clay and gravel such as might be expected on brickfields have been found here.

Although no actual evidence exists of the manufacture of pottery in this district for a hundred years after the Conquest, there is no reason to doubt that it continued here as elsewhere.

The prevalence of the industry is shown by such place-names as Potters Bar, Potters Crouch, Potters Green in Little Munden, Potters Heath between Welwyn and Datchworth, Potten End in Berkhamstead, 'Pot-terereshegge' in St. Albans, mentioned in a

INDUSTRIES

deed of 1465,¹ and Potterswick in Sandridge.² The first documentary reference appears on the Pipe Rolls of Henry II,³ where from 1158 to 1167 the Sheriff of Hertfordshire accounts for a yearly payment to William 'Pottarius' of 30s. 5d. This, it may be pointed out, is equivalent to a penny a day, and it is tempting to infer that William was employed at that rate of wages to supply the royal household with earthenware. No hint is given of the whereabouts of his kilns, and the earliest mediaeval pottery kilns of which we know anything in Hertfordshire appear to be those of which traces were found in 1892 at Gustard Wood Common, near Wheathampstead.⁴ The earthen vessels and potsherds found, some of which are now in the County Museum at St. Albans, show the thumb-pressed base and other characteristics of 14th-century pottery. The manufacture of earthenware continued in this neighbourhood for several centuries, a potter being presented for taking clay on Harpenden Common to make pots in 1573,⁵ and one Torpen, a potter, being in the same way presented as late as 1733 for taking clay from Balmwell Wood in Harpenden.⁶ At the end of the 14th century, in 1397, we find John Potter amerced for digging in the lord's warren at Great Munden,⁷ and next year the same man was attached for debt by the seizure of divers earthen pots.⁸

The commonest type of domestic earthenware of the 17th to early 18th century, numerous fragments of which are found in many parts of the county, is that having a red earthenware body covered with a thick lead glaze, coloured dark brown or almost black by the addition of manganese or iron. Although Staffordshire was the chief seat of its manufacture, it is possible, as Professor Church⁹ points out, that much of it was produced wherever a small potter's kiln existed. At a disused brickfield near Kensworth numerous fragments and a few perfect examples of this ware have from time to time been found, the colour and nature of the clay approximating in character very closely to that of the soil.¹⁰ In the County Museum, St. Albans, are to be seen certain examples of mediaeval and later pottery found in the county which have been moulded by hand (not turned on the wheel), and in these there is noticeable the same fine red clay body as employed in the local manufacture of tiles.¹¹ One is almost tempted

to assign such occasional and crudely fashioned specimens to local origin.

Possessing abundant supplies of brick earth, and having always before them the object lesson of the great abbey church of St. Albans, built largely of Roman tiles, or bricks, from the ruins of Verulamium, it was only natural that the men of Hertfordshire should practise tile-making from an early period. There is evidence that roof tiles were made at Berkhamstead in the early part of the 13th century,¹² and it is probable that most of the elaborate decorated, so-called encaustic, paving tiles used in St. Albans Abbey Church were made locally. No place of origin is assigned for the tiles bought in 1282 and 1286 at 3d. the hundred for repairs at Shenley,¹³ but they were probably made locally, as there was a 'tylhouse' here in 1386.¹⁴ For building operations at King's Langley the chief source of the tiles was 'Botelee'.¹⁵ In 1362 as many as 123,500 tiles were bought from Roger 'Tiller' and his partners, with which to roof the buildings injured by the great storm,¹⁶ and also a new mill and barn. The price of these tiles was 5s. 6d. the thousand, while 1,150 'riggetill and hepetill' (i.e., ridge and hip tiles) bought at the same time cost 5s. the hundred.¹⁷ Four years later 3,000 flat tiles were bought of Richard Tielere, of 'Botelee,' at 4s. 6d. the thousand and 200 hollow tiles at 4s. 6d. the hundred, but at the same time 3,000 flat tiles were bought from Simon Molder, of Ruislip (co. Middlesex), at only 3s. the thousand.¹⁸ In 1369 more tiles were bought of John Rod, Richard Tyler and Walter Ordwy, of 'Botelee,' and 500 Flemish tiles were bought in London for 3s., a price which suggests that they were bricks, for which Flemish tiles was the common term, rather than ornamental paving tiles, which are sometimes so called. Tiles were also bought at this time from John Rede of le Leyhull at 4s. the thousand, and 5,000 tiles, as well as a large quantity of broken tile for making a road, were obtained from Rickmansworth.

At Sacombe, in Broadwater Hundred, there was attached to the manor-house in 1420 'a building for the making of tiles,'¹⁹ and in 1475 Sir John Say had a kiln at Bedwell, 500 'tiles called Breks' being sold that year for 3s.²⁰ It

¹² *V.C.H. Herts.* ii, 162, quoting Close Roll of 1224.

¹³ *Mins. Accts. bdle.* 868, no. 13, 15.

¹⁴ *Rentals and Surv. (Gen. Ser.)*, R 297.

¹⁵ The identity of this place is uncertain, and it is possible that it was outside the county.

¹⁶ This was the storm of 8 January 1362, which caused such a demand for tiles that a special order was given against tilers charging extra for their tiles or labour (*Riley, Mem. of Lond.* 308).

¹⁷ *Exch. K.R. Accts. bdle.* 466, no. 2.

¹⁸ *Ibid.* no. 3.

¹⁹ *Chan. Inq. p.m.* 15 Hen. VI, no. 2.

²⁰ *E. Herts. Arch. Soc.* iv (2), 193.

¹ *Anct. D. (P.R.O.)*, C 754.

² Occurs 1585 (*Herts. Gen. and Antiq.*), ii, 58.

³ *Pipe R. Hen. II* (*Pipe R. Soc.*), *passim*.

⁴ *Proc. St. Albans Arch. Assoc.* 1892, p. 7.

⁵ *V.C.H. Herts.* ii, 295. ⁶ *Ibid.*

⁷ *Ct. R. (Gen. Ser.)*, portf. 175, no. 11.

⁸ *Ibid.*

⁹ 'English Earthenware,' *S. K. Handbook*, 20.

¹⁰ Inform. from Mr. G. E. Bullen.

¹¹ *Ibid.*

A HISTORY OF HERTFORDSHIRE

is probable that Hitchin was another centre of the manufacture at this time, as the 15th-century house known as the Coopers' Arms Inn was formerly the hall of the Tilers' Gild,²¹ and the survival of the name Tilehouse Street²² suggests that the gild were concerned not only with the affixing but also with the making of tiles, 'tilehouse' being the common name for a tiler. At Napsbury, shortly before the Dissolution, the last Abbot of St. Albans when making a lease of the manor reserved the Tylehouse and the land where clay was dug for making tiles and bricks.²³ Somewhat earlier, in 1508, the Prioress of Sopwell leased the manor of Corsers in Ridge to Agnes Brook at a rent of £4 10s. and a yearly render of 4,000 tiles and 2 quarters of stone lime, and in 1532 the reversion of the manor was granted to the Duke of Norfolk on the same terms.²⁴ In the lease to the duke was included a tile kiln, which passed to St. Albans Abbey and was afterwards annexed to Tyttenhanger. The kiln was said to be in decay when it was granted to Sir Thomas Pope after the Dissolution, but was leased by Sir Thomas Pope Blount to Harry Brocke in 1594 and still belonged to Sir Thomas at his death in 1639.²⁵

From the 15th century onward bricks occupy a position of increasing importance, either in conjunction with tiles or by themselves. They were made as early as 1425 at Rickmansworth, 2,000 'breks' being bought from John Flete of that place for chimneys at King's Langley at 6s. 8d. the thousand.²⁶ Another 500 bricks were bought at the same time in St. Albans. The bricks used at Hatfield both for the bishop's palace in the 15th century and for the house erected by the Earl of Salisbury early in the

17th century were probably of local manufacture, as were those used for Tyttenhanger House.²⁷ Little of interest can be said about this industry, important though it undoubtedly was and is as a source of employment. A brickfield is mentioned at Shenley in 1614,²⁸ and there are occasional references to brickmakers, as, for instance, Edward Marshall of Kempton in 1668,²⁹ Oliver Maine and Thomas Deely of Winslow³⁰ in 1708, Joseph Sanders of Hemel Hempstead and John Hays and William Hutchins of Rickmansworth in 1714,³¹ and George Humberstone of Graveley in 1746.³² During the 18th century Harpenden was one of the chief centres; in 1728 and again in 1742 several persons were presented for digging chalk and clay to make bricks on Harpenden Common and Nomansland, and in 1759 there were brick kilns on the common.³³ G. A. Cooke,³⁴ writing in the first quarter of the last century, describes an elaborate railway drawn by a horse for the conveyance of bricks from Cheshunt Park to the Lea. Originally large quantities of furze were burnt in the kilns, and these were constructed so that the flame came into direct contact with the bricks. The bricks themselves were packed in such a way that the 'heads' or ends were exposed, and owing to this system of firing a slight amount of true homogeneous glaze, together with a darkening of the surface, was produced.³⁵ At the present time the chief centres of brick and tile-making are Hemel Hempstead and Hitchin, but the industry is widely distributed over the whole county, with fields at Watford, Elstree and Barnet in the south, Tring and Berkhamstead in the west, St. Albans, Welwyn and Stevenage in the centre, and Buntingford and Bishop's Stortford in the east.

PLASTER WORK

Examples of ornamental plaster work, or pargeting, are more commonly met with in the eastern half of the county and are really allied to what may be called the Essex plaster crafts. The most usual form, often called 'combed work,' was produced by the use of an instrument resembling a comb with short teeth, by means of which the surface of the wet plaster was scored with a variety of simple patterns resembling basket-work, scales, &c. This form of ornament may have had an early origin, and many examples occur on houses of late 16th-century date, but it is often impossible to be

certain that the plaster is original. Moreover, the method continued in use down to the middle of the 19th century and has recently been revived. The earliest form would appear to be that in which the whole surface of the external plaster was covered with one pattern, only interrupted by the openings made for doorways

²⁷ A quantity of what seemed to be refuse from brick kilns was found in the grounds of Tyttenhanger. (Inform. from the Editor *V.C.H.*)

²⁸ *V.C.H. Herts.* ii, 265.

²⁹ *Herts. Gen. and Antiq.* ii, 1668.

³⁰ *Ibid.* iii, 311.

³¹ *Ibid.* 375, 377.

³² *Ibid.* ii, 142.

³³ *V.C.H. Herts.* ii, 295.

³⁴ *A Topog. and Statistical Deser. of the County of Hertford* (1825), 62.

³⁵ From local information obtained at Kensworth by Mr. G. E. Bullen.

²¹ *V.C.H. Herts.* iii, 5.

²² *Ibid.* 3.

²³ *Ibid.* ii, 416.

²⁴ *Ibid.* 390.

²⁵ *Ibid.*

²⁶ *Exch. K.R. Accts. bdle.* 466, no. 11.

INDUSTRIES

and windows. Of the remaining examples of this none appear to be earlier than the end of the 16th century.

About this date a more elaborate form of plaster ornament appeared in Bishop's Stortford and the neighbourhood. This consisted of rectangular and diamond-shaped panels cast in low relief from moulds giving such ornamental forms as a lion rampant, a crown, a fleur de lis, a two-headed eagle, a species of carbuncle, and others. These appear to have been inserted in plain or combed plastering, but in all the examples which remain the surrounding plaster is of doubtful antiquity and in many has been covered with rough-cast up to the margin of the panels. Cases occur at Bishop's Stortford, Braughing, Albury, Stanstead Abbots, and elsewhere. At Much Hadham is a small house where some of these forms are used internally as ceiling decoration. It would appear likely that these are all the work of one craftsman or 'shop' with head quarters in Bishop's Stortford. Plaster is also used at this period to represent stone dressings on brick buildings; the grammar school, Buntingford, provides an example of this.

At St. Michael's Manor House, St. Albans, is a moulded plaster ceiling with moulded panels, foliate ornament and the initials I.G. (for Sir John Gape), and the date 1586. Another ceiling in No. 54 Holywell Hill, perhaps a little later in date, is ornamented with moulded ribs and circular plaques containing heads of a crude classical character. Similar heads to these appear to have existed, originally, in the ceiling of the hall of Hatfield House, c. 1611, but were replaced in the 19th century by paintings. Hatfield House contains many elaborate plaster ceilings, for the most part of doubtful antiquity, but the ceiling of the long gallery retains its original form and is a good example of the elaborate interlaced strap and arabesque work of the 17th century. The sequence of examples of internal work is continued in a house at Ware, on the south side of the High Street, in which is a room on the first floor, with a plain barrel ceiling of plaster and lunettes at each end decorated with elaborate arabesques in low relief. These bear the initials I.H.S. and the date 1624.

By the middle of the century a new form of external decoration in plaster came into use. The wall surfaces were cut up into panels of rectangular, L-shaped, circular and oval form, and of comparatively small size, by raised mouldings in a manner which closely corresponds to the woodwork of the period. A shop in the High Street, St. Albans, which is dated 1665, is an example of this type of decoration. Internal work of about the same date occurs in the back

rooms of a shop in the High Street, Ware; the ceilings here have square and round panels, formed by flat-reeded mouldings, containing shields with a lion passant between three crosslets; the same shield appears in plaster over the fireplace in one of the rooms.

Toward the end of the century the tendency to increase in size which is shown in the carpenters' panelling appears also in the plasterers' house fronts, but the heavy bolection mouldings of the wooden panelling were not attempted in the plaster work. In their place the panels were marked off by narrow bands of running foliate ornament in very low relief. The combed work also appeared, or reappeared, and was much used for the decoration of the panels themselves, the styles and rails being left plain. The outside of St. Michael's Manor House at St. Albans is a good example of this style. At the same time other and quite different forms of plaster work appeared. A house in Hitchin, No. 17 Tilehouse Street, has quoins of plaster and rough-cast walls, and there is similar work at The Causeway, Braughing. Elaborate modelled work in relief was also used. A small house at Ashwell, dated 1681, has ornament of this type in the form of dolphins and acanthus foliage. An example of more elaborate work of this kind is provided by a house of considerable size in Fore Street, Hertford. In this case the ornament is mainly in the form of acanthus volutes, originally designed to cover the whole wall surface; later alterations have caused considerable damage.

During the early part of the 18th century the panelled plaster fronts with combed panels and plain styles and rails continued, but the strips of running ornament went out of use and plain beadings took their place. A dated example of this occurs at Hitchin, where a 15th-century house was refronted with plaster in 1729. The use of timber for building became less and less common at this time, and in consequence external plaster work of the 18th century is usually in the nature of repairs to earlier buildings.

The internal plaster work of the 18th century offers no features of local peculiarity, but at Moor Park, Rickmansworth, are examples, possibly the finest in England, of elaborate modelled work in high relief. The ceiling of the white drawing room carries the plasterers' art, perhaps, to the highest possible point of elaboration and richness.

In recent years, following the revivalist movement of the end of the 19th century, the local 'combed' work has been essayed again with some success. Some examples of this, as of most other styles, may be found at Letchworth.

A HISTORY OF HERTFORDSHIRE

BELL-FOUNDING

Neither in mediaeval nor in later times did the county of Hertford contain any bell-foundry of long standing or extended reputation, like those of Nottingham, Reading, Gloucester, or Bristol, yet bells were cast from time to time within its borders, and in the 17th and 18th centuries temporary foundries were set up in at least four different centres.

The records of the abbey of St. Albans afford more or less definite evidence that the bells of that church were more than once cast on the spot, and moreover that the founders in these cases were not ordinary tradesmen, but actual members of the monastic foundation. The earliest record of this kind goes back to the 13th century, a period when we have little or no evidence of the existence of regular bell-founders such as we hear of in London and other towns during the 14th and succeeding centuries. Although very few remaining church bells can be traced back to that early date, the existence of towers built to hold them is sufficient proof that they were in general use as far back as the 11th century at least. Yet the names of known founders before 1300 are exceedingly few, and it seems probable that the art of bell-founding was largely practised by the monastic orders before it was organized into a trade. At a later time we find occasional evidence of ecclesiastical bell-founders, and therefore this need excite no surprise.

We read then in the Chronicles of St. Albans that in the days of Roger Norton, the twenty-fourth abbot (1260-90), some important work was carried out in connexion with the bells, together with other improvements associated with his rule. Previously there were four bells, given in 1077-93, and for these were substituted three of larger size. 'A great bell truly and a most sonorous one, called by the name of St. Amphibalus, he caused to be made for tolling the curfew daily, other two bells in honour of St. Alban and St. Katherine being made at the same time, under the superintendence of Sir John de Marins, then prior of this church, out of four old bells broken up, without adding the smallest quantity of metal.'¹

We are not, of course, definitely told that Sir John de Marins actually took part in the casting or designing of the bells, but it seems pretty clear that they were made by ecclesiastical and not secular craftsmen under the direction of the prior himself. More direct evidence of monastic achievements in this line appears in the time of Michael Mentmore, twenty-ninth abbot (1335-49). The great bell called Amphibalus (mentioned above) was broken while

curfew was being tolled, and was recast by Friar Adam de Dankastre in the hall of the sacristy.² It seems likely that he was also the maker of a successor to the St. Alban bell about the same time, as there is a record of the consecration of these two bells by Lord Hugh, Archbishop of Damascus. About 1370 a new bell was made and named 'Christ,' and in 1485 another was christened 'John,' but there is apparently no record of their maker. The five old bells of the abbey, which survived the Dissolution, were recast by Philip Wightman, of London, in 1699, and in that form four still remain.³

There appears to be no trace of any secular bell-founders in the county during the period preceding the Reformation. Of the thirty mediaeval bells still remaining in the county, no less than twenty-one were cast in London and five at Toddington in Bedfordshire (by John and William Rufford). There is one example from each of the foundries at Bury St. Edmund's, Reading, and Wokingham.⁴ But there remains one bell of unique character, which cannot be assigned to any known foundry, viz., the second at Little Berkhamstead. The inscription

† AVE MARIA GRACIA PLENA DOMINVS TECVM
BENEDICTA TV IN MVLIERIBVS

is in small Gothic capitals, rather rough and carelessly stamped, and placed closely round the upper part of the bell, without the usual intervening stops between the words. The initial cross has plain trefoils at the ends of the arms. Neither cross nor lettering has been found on any other bell, and it is quite probable that it is the work of a local (? Hertford) craftsman, dating from about the middle of the 14th century.

There is an early bell at Clothall, near Baldock, with the curious inscription

† CALIT : ME IOANNES

of which no satisfactory interpretation has as yet been given. The lettering is also found on a bell at Rawreth, in Essex, and was originally in the hands of the London founder, Richard Wymbish (about 1300-20). Subsequently it reappears, with the same plain cross as at Clothall and Rawreth, on a bell by Robert Rider, of London (1350-86), at Ridgewell, in Essex. The two first-named bells have, in common with the Wymbish bells and others

² *Gesta Abbat. Mon. S. Albani* (Rolls Ser.), ii, 363.

³ For the history of the St. Albans bells see Stahl-schmidt, *Ch. Bells of Herts.* 98 ff.

⁴ Two others, formerly at Sawbridgeworth, were cast just over the Essex border about 1540.

¹ *Gesta Abbat. Mon. S. Albani* (Rolls Ser.), i, 483.

INDUSTRIES

known to be by London founders of this time, a peculiar flat moulding above the inscription.⁵ This small point seems to be sufficient justification for assigning them to a founder in the metropolis. It is further probable that they date from the intervening period between Wymbish and Rider. Now, there was a founder of this period who, though working in London, was probably a Hertfordshire man, one John de Hadham, whose name occurs in records between 1330 and 1339.⁶ The Clothall and Rawreth bells may fairly be assigned to him, and as 'Johannes' on the former probably denotes the founder, not the donor, this supplies additional evidence.

It is not until after the middle of the 16th century that we meet with any definite evidence as to bell-founding in Hertfordshire. In 1557 the name of a bell-founder, Clarke, living at Datchworth, occurs in connexion with some bells at Graveley, brought from the priory of Wymondley. Among the Land Revenue papers at the Record Office is a certificate of their weight made 26 May 1557: 'The weyght of the said iiij belles by estimacion of a bell funder woos name is Clarke dwellyng at Thesthewurth in the Count' of Hertf' . . . dowth wey xvij hundryth weyght,' &c. Thesthewurth is obviously intended for Datchworth (near Welwyn), which was formerly spelled and is still sometimes pronounced Thatchworth. Stahl-schmidt⁷ identified as this founder's work a bell (the fifth) at Braughing, which is inscribed

DEUS IN ADIUTOUIR MEU INTENDE IC 1562

the date being placed on the crown above. The Datchworth registers unfortunately only begin in 1570, and yield no information about this Clarke, whose Christian name may be assumed to have been John, but between 1572 and 1587 there was a John Clarke living there, probably the bell-founder's son, and the baptism of seven of his sons is recorded. One of the latter, baptized in 1575 by the name of John, may possibly be identical with a bell-founder who flourished between 1599 and 1621. The bells by this later John Clarke are, however, very widely scattered, and he is more likely to have been an 'itinerant' than to have had a settled home, like many other founders of the period. One of his bells occurs in Hertfordshire, at Eastwick, dated 1601. There are six in Essex and solitary specimens in Bedfordshire, Buckinghamshire, Hampshire, Kent, Norfolk, Suffolk and Sussex.

There are two or three other itinerant founders

⁵ It occurs on the treble at Little Hallingbury, Essex, which has no inscription, but is probably by the same founder as Clothall.

⁶ See Stahl-schmidt, *Surrey Bells*, 73; Deedes and Walters, *Ch. Bells of Essex*, 6.

⁷ *Ch. Bells of Herts.* 32.

who have left their traces in Hertfordshire about this period, the best known of whom is John Dier (1577-98), twelve bells by whom remain in the county. Five of them being dated 1595, it is probable that he was at that time temporarily residing somewhere in the neighbourhood of Hitchin, where they are chiefly found. The others range between 1580 and 1597, and one at Hemel Hempstead is undated. Dier's work is found in most of the neighbouring counties.

John Grene cast bells for Harpenden in 1571 and 1574, both now unfortunately recast. He is otherwise only known in Huntingdonshire and Essex. There are also specimens of the work of a nameless founder in three towers round Baldock (Clothall, Newnham and Norton), which belong to the same period. His bells occur in Bedfordshire,⁸ Buckinghamshire, Cambridgeshire and Northamptonshire, and are remarkable for their unintelligible inscriptions, a meaningless jumble of crowns, fleurs de lis, and odd letters; none of them are dated.

When we reach the 17th century we find ourselves on firmer ground, and the first genuine local founder appears on the scene. This is Robert Oldfield, probably an offshoot of the famous bell-founding family at Nottingham,⁹ though of this there is no proof. Little is known about him except that he was a resident in the parish of St. Andrew, Hertford.¹⁰ Here in St. Andrew's Street, exactly opposite the church of that name, is an inn, known in 1624, as at the present day, as the Little Bell Inn. In 1625 it is mentioned in the Corporation Archives as the 'Bell Mould,' and from 1628 to 1726 as the 'Golden Bell,' and the name has since varied, but always retained the word 'Bell' in some form. Here we learn from the archives that Oldfield was resident until 1640, when the name of the tenant is given as John Oldfield (probably a son), who held it till 1660. At the back of the inn are workshops and a yard in which the founder probably carried on his business. There is no record in the parish registers either of St. Andrew or All Saints of Oldfield's birth, marriage, or burial, but in 1622 a son of his was buried, and another shortly after, both at St. Andrews. If he came originally from Nottingham or elsewhere this might explain the absence of birth or marriage records; of his death we have other evidence. His administration bond, dated 7 May 1650, is at Somerset House, and he is there described as of the parish of St. Andrew.¹¹ In the registers of

⁸ 'John Bunyan's bell' at Elstow is one of this group.

⁹ See *V.C.H. Notts.* ii, 369.

¹⁰ For most of the following particulars the writer is indebted to the kindness of Mr. W. F. Andrews, of Hertford. See also *Herts. Mercury*, 31 March and 21 April 1888.

¹¹ Cocks, *Ch. Bells of Bucks.* 163.

A HISTORY OF HERTFORDSHIRE

that parish 'old widow Oldfield's' burial occurs on 16 May 1673, and it is quite likely that she was the relict of the founder. His name also occurs in the churchwardens' accounts of the parish of Shillington (co. Beds.), for which he cast a bell, still existing, in 1638¹²; he is there described as located at Hertford.

The last-named bell bears a shield with an arrow in pale and the letters R.O., which has made it possible to identify as his work nearly eighty bells, the majority of which bear this

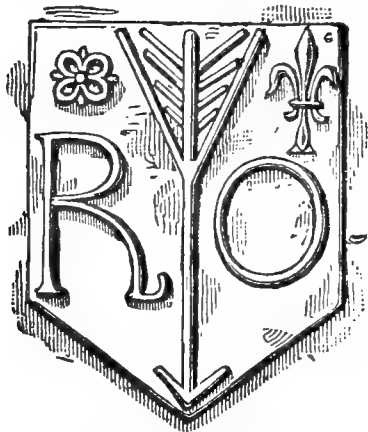

STAMP OF ROBERT OLDFIELD

stamp. They cover the period from 1605 to 1640, and there are two in Bedfordshire, three in Cambridgeshire, one in Lincoln, twenty-four in Essex, and forty-eight in Hertfordshire, of which two have been recently recast. They are inscribed in plain Roman letters, with an initial cross, of which there are three varieties—a plain one, a cross crosslet, and a floreated cross. They fall into two distinct chronological divisions: in the earlier (1605–16) the letters are thick and the cross crosslet is used, in the later (1616–40) the lettering is thin and somewhat larger, the plain cross being used down to 1621, and then the floreated cross. His stock of inscriptions is somewhat limited; the favourites are

GOD SAVE THE KING

and

PRAYSE YE THE LORD

We also find

GOD SAVE HIS CHURCH

IESVS BE OVR SPEDE

and in Latin

SONORO SONO MEO SONO DEO

The seventh at Hemel Hempstead is inscribed SANA MANET CHRISTI PLEBISQVE RELIGIO VANA. Four of his bells remain at Broxbourne, three at Tring, and three at Kimpton. As Stahlschmidt has pointed out, the number remaining, especially in this county, clearly shows that he had a steady and profitable business. On his retire-

¹² North, *Ch. Bells of Beds.* 69, 190.

ment in 1640 the foundry was closed, and bell-founding in the county town ceased for some 140 years.

In 1656 a ring of six bells was cast for Waltham Abbey in Essex by a founder of the name of William Whitmore at Wollford (*sic*), Hertfordshire.¹³ The only reasonable interpretation of the name 'Wollford' is Watford, and, as there are three or four bells by the same founder in the immediate neighbourhood of that town, this is additional confirmation. Like many other founders of the period he was an 'itinerant,' coming originally from the West. The bells of Frocester, in Gloucestershire, were cast by him in 1639, but these are the only specimens of his work in that part, and shortly afterwards he appears to have migrated to Watford. Here in 1647 he cast the priest's bell at Aldenham, followed by three bells for Langley Marish (co. Bucks.), in 1649, two for the curfew tower of Windsor Castle in 1650, and one for Epping town, Essex, in the latter year. Next we hear of him in 1653, which year he apparently spent in Essex, probably at Chelmsford, in the neighbourhood of which town eight bells bear that date and his initials or lettering. Here, however, he was not working independently, but undertaking commissions for a newly-established London founder, John Hodson. At Boreham we find on the treble the initials W.W., on the tenor the names (in full) of both founders. Similarly at Good Easter the first bore the initials I.H., the fifth W.W. At Steeple Bumpstead only Hodson's name appears, and at Sandon and Springfield it is accompanied by a single W. for Whitmore, but it is worth noting that in all cases the lettering is Whitmore's. In 1654 he was back again at Watford, and has left a bell at Bovington. Others in Bedfordshire and Middlesex are dated 1656, with his initials, and his latest effort was at King's Langley in 1657. The fifth at Hertingfordbury is interesting as showing that he renewed his connexion with Hodson; it is inscribed

ICEPE DVLCSE SEQVAR W WHITMORE FOR
JOHN HVDSON 1656

The fourth bell in the same tower is also his work and of the same date. His bells are very plain, the only ornament being a lozenge-shaped stop, varied during the Essex period by one in the form of a X with a lozenge above and below.

In or about the year 1699, according to tradition, Richard Keene, a founder who had been working for many years at Woodstock, in Oxfordshire, set up a temporary foundry at Royston. There is no actual evidence of his residence there, except the testimony of the bells themselves, all of which are in the neigh-

¹³ Deedes and Walters, *Ch. Bells of Essex*, 112, 430.

INDUSTRIES

bourhood of that town; his name does not occur in the parish registers, though, as he must have been an old man of over sixty when he came, he probably ended his days there. His career in these parts only extended over five years (1699-1703), but he was extraordinarily active during that time, and left over fifty bells, of which only one bears his name, though they are easily recognized by the lettering. They were, however, more remarkable for quantity than quality, as a dozen at least have since been recast. Of five complete rings in Essex (Arkesden, Hadstock, Heydon, Langley, and Wendens Ambo) none now remain complete. There are eighteen of his bells in Cambridgeshire and about thirty in north-west Essex, but only two can be traced in Hertfordshire, the trebles at Anstey and Great Hornead. Many bear the date alone, often in very rough figures, the rest usually churchwardens' names. All are quite devoid of ornamentation.

The latest of the itinerant founders, John Waylett (1703-31), was not only a Hertfordshire man by birth, but spent the greater part of his active career there in his native town of Bishop's Stortford. He first appears in 1703 as the founder of a bell for Stanford le Hope, in Essex, and for the next ten years produced a fair number of bells for Essex, Hertfordshire, and Cambridgeshire, also one for Middlesex. In 1712 he migrated temporarily to Sudbury and cast two bells in Suffolk, in conjunction with John Thornton of that town. Though most of his earlier bells are in its neighbourhood, we get no evidence of his connexion with Bishop's Stortford before 1715, in which year he cast a bell for Meldreth (co. Cambs.), and is described as 'John Waylett of Bishop's Stortford.' In 1716 he cast another bell there for the same parish of Meldreth. It is worth noting that when the Bishop's Stortford bells were recast by him in 1713 there is no item for carriage in the parish accounts. Meanwhile in 1714 he had begun another migration to Sussex, where he remained for a year or two, casting nine bells in the neighbourhood of Hastings, and establishing a connexion which lasted for ten years. In 1716 he appears to have entered on a business arrangement with another founder, Samuel Knight, of London. Two bells of that year at Redbourn bear his name, but the lettering is Knight's, whose name appears on a third. Probably he executed commissions like Whitmore. In 1721 the initials of the two men appear on a bell at Stowting, in Kent, cast by Waylett while at Hythe, as may be learned from an existing agreement. Apparently he was at Bishop's Stortford working for Knight for five years; he then set out on a tour over the Home Counties, and we find his bells in Surrey in 1718, in London in 1721, in Kent between 1717 and 1727, and also as noted in

Sussex. All his Kent bells between 1721 and 1724 are in the neighbourhood of Hythe. Finally in 1727 he took up his residence in London, and cast ten bells between that year and 1731, seven of which bear the words JOHN WAYLETT, LONDON. It is curious that the tenor bell of Bishop's Stortford should belong to this period, being dated 1730, but it may well have been cast by him on a temporary visit to his old home. We do not know the date or place of his death, but his name occurs in the records of the Founders' Company in 1740, when he was an honorary member, having long retired from business. In all he appears to have spent rather more than half of his active career at Bishop's Stortford, from 1703 to 1721, with the exception of occasional migrations in 1712 and 1714-15, and perhaps during the next five years; it is not likely that he cast any of the Kent, Surrey, or Sussex bells on the far side of London. There are altogether twenty-six bells by him in Hertfordshire, out of a total of 130, of which four are at Sandon and four at Stortford. There are also twenty-four in Essex which belong to the Bishop's Stortford period, and about eighteen in Cambridgeshire. Compared with other itinerant founders his workmanship is decidedly good, and it is clear from his career that he had established a widespread reputation.¹⁴ His bells seldom bear anything but the words JOHN WAYLETT MADE ME, or the same in Latinized form, with the date, and sometimes a fleur de lis as a stop.

The last, but by no means the least, of the Hertfordshire founders is John Briant (1782-1825), who after a period of 140 years re-established this industry in the county town, and is described by Stahlschmidt as 'the Herts founder *par excellence*.' He was born at Exning, in Suffolk, and sent to school at Newmarket, with a view to his taking holy orders, but his mechanical tastes, and in particular his interest in clocks and chimes, turned him in another direction. His first work at Hertford was the recasting of the bells of St. Andrew's into eight in 1782, and his success soon established a large connexion. Stahlschmidt says he was noted as a 'splicer,' and particularly in adding trebles to a ring of bells, as at All Saints, Hertford, and St. Peter's, St. Albans. The same writer¹⁵ gives a list of bells cast by him, from a book in the possession of the College Youths of Hertford, and claims as his masterpiece the tenor of St. Michael's, Coventry. The list, which was probably compiled about 1807, is naturally incomplete, but includes six rings of eight bells, eleven of six, and five of five, besides about 120 additions to rings. In Hertfordshire he cast rings of eight for Hatfield and Hertford,

¹⁴ See Deedes and Walters, *Ch. Bells of Essex*, 120

¹⁵ *Ch. Bells of Herts*, 65.

A HISTORY OF HERTFORDSHIRE

rings of six for Barkway and North Mimms, and rings of five for Codicote, Rushden, and Wallington. Other famous specimens of his work are the rings of eight at Waltham Abbey and Saffron Walden; at St. Alkmund, Shrewsbury, and Condober (Salop); Adderbury (Oxon.), and St. Ebbe's, Oxford; and others at Barnstaple (Devon); Soham (Cambs.); St. Giles, Cripplegate, London, &c. His latest bell in Hertfordshire is at Hinxworth, dated 1825. His foundry was near Castle Lane, subsequently occupied by Mr. Simpson, printer.

His bells are usually inscribed in a small neat type:

JOHN BRIANT HERTFORD FECIT

with the date, the name of the town being sometimes spelled 'Hartford.' He seldom breaks out into poetry like some of his contemporaries, but examples may be seen at Littlebury (Essex), Shrewsbury, St. Alkmund, and High Erccall (Salop), the effusions in the two latter cases being the work of a well-known local poet. He is fond of introducing small ornaments in his inscriptions, such as a calvary cross, a cross paty, and a double triangle. That he was also a successful clockmaker the present clock at Hertford Town Hall bears witness. His skill as a founder and his conscientiousness in business are well evidenced by a correspondence with the Dean and Chapter of Lincoln, who applied to him about the bells of their

Cathedral, and in particular about 'Great Tom,' then (1827) being cracked. The correspondence is preserved among the cathedral documents, and is given *in extenso* by Stahl-schmidt.¹⁶ His advice was unfortunately not followed for some time, and, after several abortive attempts to mend 'Great Tom,' it was finally recast in London in 1834. At the time of this occurrence Briant was nearly eighty years of age, and he states that he has 'declined bell-founding,' but is ready and willing to give disinterested advice. It appears that in spite of his reputation for mechanical skill and integrity in business his trade had for some years been declining, partly, perhaps, on account of advancing years, partly from the competition of the great firm of Mears, of Whitechapel. However this may be, he fell into pecuniary difficulties, and was compelled to end his days in an almshouse at St. Albans, where he died 27 February 1829, aged eighty. His business had been sold not long before to his successful rival Mears. A contemporary writer, Lewis Turnor,¹⁷ attributes his misfortunes to his generosity and liberality of disposition, and to the fact that he had a great aversion to pressing for the discharge of money owing to him. He was buried in All Saints' churchyard at Hertford, and a muffled peal was rung at that church by the Hertford College Youths. He was twice married, and left two daughters, but no son.

WATER-CRESS GROWING

The culture of water-cress for table use, although practised extensively for many years previously in Germany and elsewhere on the Continent, does not appear to have been introduced to this country prior to the first quarter of the 19th century.¹

Hertfordshire, on account of the abundance and purity of its water supply, was one of the first counties in which the industry was at first largely prosecuted, and the crops produced in certain areas, notably around Welwyn, were considered to be of very high quality.

One has to consider the fact of a decreasing water supply in the county to realize that at the present day the industry is no longer in the prosperous condition of former years. Many of the beds, or 'ditches' as they are locally called, which originally were fed by small rivulets and streams, are now unworkable during the summer months, and it may almost be stated that only those areas of cultivation adjacent to the larger watercourses of the county yield regular and profitable crops. Moreover, a diminution of water during the summer months,

when the best season for production is at its height, causes a greater amount of impurity in the beds, chiefly due to the decomposition of diatomaceous and other protophytan matter; and, whereas suitable precautions are taken to exclude impure matter of a larger description, this may be cited as a further deterrent factor in the full development of the industry.

Although water-cress is grown throughout the county wherever suitable conditions exist, the most extensive areas of production are those which occur naturally below the level of an adjacent waterway. A large acreage of what would otherwise be damp pasture is thus utilized along the margin of the Grand Junction Canal and the Rivers Lea and Colne with their tributaries. At Rickmansworth and Boxmoor Mr. Chas. Sansom owns beds of considerable extent. Two other members of the family, Mr. A. Sansom of Welwyn and Mr. T. Sansom of Redbourn are also large growers.

¹⁶ *Ch. Bells of Herts.* 57 ff.

¹⁷ *Hist. of the Borough of Hertford*, 407. He gives a biography of Briant as one of the town's notable men.

¹ See *Encycl. Brit.* (ed. 10).

INDUSTRIES

Other important areas of cultivation occur at Berkhamstead, Hoddesdon, Hemel Hempstead, and Boxmoor, Wheathampstead and St. Albans. Three distinct varieties of the plant are cultivated—namely, the green-leaved, the small brown-leaved, and the large brown-leaved; the first two apparently more extensively than the latter, which grows best in deep water.

The trenches vary in extent in different parts of the county, but as a rule they are not less than 10 ft. broad by 90 ft. in length. The bottom is made slightly sloping, and in such a way that a regular depth of about 4 in. of water can be maintained.

In the planting of a bed a small quantity of water is first allowed to enter in order to soften the ground. Slips or cuttings, each bearing roots, are then planted at a distance of about 3 or 4 in. apart in rows parallel to the direction of the current. A slight dressing of manure is applied at the end of four or five days, and this is pressed down by means of a heavy wooden board, to which a long handle is obliquely attached. Water is then allowed to enter the trench in full volume to the depth already mentioned.

Each bed furnishes about twelve crops

annually, the cresses being cut during the summer about every twenty days, and less frequently in winter. Two-thirds of a bed are usually cut at once, manuring being performed after each gathering. Owing to this treatment the level of the bottom of the trench is gradually heightened, and at the end of twelve months the bed is cleared and the refuse removed, a fresh planting being effected. In many places the soil removed and thrown on to the margins separating adjacent beds is utilized for the growing of vegetables.

The cresses are packed for market in specially constructed baskets, in double rows, with the leaves toward the interior. The greater proportion of the produce is sent to Covent Garden, but, although there are no published returns showing the extent of acreage under cultivation for water-cress in the county,² it is generally considered by those engaged in the industry that more than one-third of the total amount marketed in London is derived from Hertfordshire.

² No records in this respect are kept by the Board of Agriculture, and the weekly market reports of trade journals are insufficiently particular to be of accurate service.

FORESTRY

ALTHOUGH there is no evidence of the presence at an early time of a true royal forest, under forest law, within the bounds of Hertfordshire, there is no doubt that the greater part of the district abounded in timber and underwood from the earliest days of which there is any record. Indeed, the place-names of the county bear particular witness to the great extent of woods and woodland. Frith, the old name for a forest or woody place, is found in Frithsden, to the north of Hemel Hempstead, and also at Great Berkhamstead, Welwyn and other places. There is no doubt that the greater portion of western Hertfordshire, which lay in the Chiltern region, was at one time densely wooded. As late as 1064, the thickness of the Aldenham Woods¹ rendered the road to London dangerous for travellers. The gradual and deliberate clearing of the great manor of Wheathampstead can be traced in the charters and grants of the abbey of Westminster.²

The Domesday Survey proves that this was a county abounding in timber to an exceptional extent at the time of the Norman Conquest. It is but rarely that the Survey gives the extent of the woods or underwood of the manors by acres or by miles and furlongs as in Lincolnshire and Derbyshire. The chief value of the woods consisted in affording acorns and beechmast for the swine. Hence it came about that the woods were usually set down by the commissioners in accordance with the number of hogs they were capable of fattening. In some counties the woodland estimate was formed from the tale of pigs that it yielded to the lord in return for pannage licence, but in Hertfordshire the estimate was formed from the number of pigs that it sufficed to feed. The numbers of the swine afford a rough estimate of the size of the woods; but it is, of course, idle to attempt to form any scale of their area, as their swine-feeding capacity would depend not only on the density of the woodland area, but also on the nature of the trees. The oak and beech no doubt very largely predominated, but there were also other trees. Thus at Lilley, a large manor of nine plough-lands on the Bedfordshire border in Hitchin Hundred, in the midst of other manors furnishing provision for hundreds of pigs, the Survey states that it only supported six swine. It would be quite rash, however, to assume that the woodland area of Lilley was in consequence very small. The group of manors in the north-west of the county, which belonged to the king, were well supplied with pannage woods. Walden Regis supported 800 swine and Hitchin 600. The total of swine in the king's woods was 3,155, or an average somewhat less than 300 a manor. The lands of the abbey of St. Albans were chiefly around the monastery in the south-west of the county, where the manors were of great extent. The woodlands of Rickmansworth supported 1,200 swine and those of St. Albans, Hemel Hempstead and Cassiobury 1,000 each. The total in the abbey woods amounted to 6,710; the average per manor was over 400, but Shephall had only 10, and the two manors of Newnham and Norton, in the extreme north of the county, none. By far the greatest lay tenant of Domesday manors was Eustace Count of Boulogne; his comparatively small manors lay in a group to the north-east of the county, save for Tring at the extreme west and Hoddesdon at the south. Tring had woodland to feed 1,000 swine; but the woodland of the other twelve manors was apparently quite small, for they only averaged 17 swine apiece.³

Mention is made in the Survey of three parks in this county—namely, at St. Albans, Benington and Ware.⁴ In each case the descriptive term is *parcus bestiarum sylvaticarum*, which may be best rendered 'a park for beasts of venery.' The four beasts of venery were the hart, wolf, wild boar and hare, which were all termed *sylvestres*; they spent their days in the woods and coppices, and were taken by what was considered true hunting, being roused by lymer hounds or tufters, and afterwards pursued by the pack. Contrariwise, the beasts of the chase were *campestres*, or found by the day in open ground, and therefore required none of the niceties of tracking and harbouring, but were roused straight away by the pack; these beasts of the chase were also four in number—namely, the fallow and roe deer and the fox and marten.⁵

¹ *V.C.H. Herts.* ii, 149.

² *Ibid.* 298.

³ See Domesday map, *V.C.H. Herts.* 1, 300.

⁴ Thirty-one of these deer parks are mentioned in Domesday.

⁵ Cox, *Royal Forests*, 62, 63 and cap. iv.

A HISTORY OF HERTFORDSHIRE

The manor and liberties of Therfield were confirmed to Ramsey Abbey by Edward the Confessor, and subsequently by the Conqueror. Particulars as to the customs and services of this manor, as set forth in 1271, show various references to the woodland of the estate. Each customary tenant had to maintain a rood of fencing round the wood, to cut two faggots of sticks before Hockday and three faggots afterwards, and also to cut three faggots of underwood before Hockday and five afterwards.⁶

In this county, as elsewhere, the woodlands suffered severely through the dissolution of the monasteries. The new owners or Crown tenants endeavoured, as a rule, to make all they could out of their new possessions without much thought for the future; whereas the monasteries, save in the case of an occasional corrupt superior, regarded their woods as a precious heritage to be handed on unimpaired from generation to generation. As a check on this and other evils, an Act was passed in 1541 establishing a Court of General Surveyors of the king's lands, one of the officers being termed Master of the Woods, without whose assent no sales could be made.⁷ In 1541 the Crown appointed under this statute Geoffrey Chambers, John Peryn, gentlemen, and four others to serve as commissioners to sell, by the acre or otherwise, to the greatest advantage, 'all the underwood and wood of Connes Grove (18 acres), and Hyllys Grove (4 acres), parcel of the manor of Hatfield lately belonging to the bishop of Ely, but saving all manor of greate tymbretrees and saplyng oykes lyke to be tymbre and certyn standers in every acre of the promisses according to the Custome of the Country.' Open proclamation of the sale of the same to the highest bidder was to be made 'in the Church of the Town next adjoynnyng to the saide woode.'⁸ At the same time other commissioners were charged with the sale, under like restriction, of 36 acres of wood of the manor of Abbots Walden, late parcel of the possessions of the abbey of St. Albans.⁹ At the close of the reign of Henry VIII the Court of General Surveyors was dissolved, and its powers over wood sales transferred to the Court of Augmentations.¹⁰ This legislation, however, only applied to Crown lands, and the king's best advisers soon saw that woods in general were so speedily disappearing under the new conditions of ownership that wider restrictions were requisite. Accordingly in 1543 an Act was passed for the Preservation of Woods. The preamble sets forth that

The King our sovereign lord perceiving and right well knowing the great decay of timber and woods universally within this his realm of England to be such, that unless speedy remedy in that behalf be provided, there is great and manifest likelihood of scarcity and lack as well of timber for building, making, repairing and maintaining of houses and ships, and also for fewel and fire-wood for the necessary relief of the whole commonalty of this his said realm, &c.

It was thereby enacted that in every copse of underwood felled at twenty-four years' growth twelve standrells or store oaks (or in default of oak, elm, ash, asp or beech) be left standing on each acre; when cut under fourteen years the ground was to be inclosed or protected for four years; when cut from fourteen to twenty-four years to be inclosed for six years; cutting trees on waste or common land to be punished by fine of 6s. 8d. for each tree.¹¹ This Act of 1543 was strengthened and confirmed by Elizabeth in 1570, when the period for inclosing copses against damage by cattle after felling was extended.¹²

After this date various steps were taken during Elizabeth's reign to check the spoiling of the woods of Hertfordshire. In 1575 a special commission was issued to inquire into the wastes and spoils of wood on lands belonging to Colney Chapel¹³; this district, now known as Colney Heath, lay about 3 miles to the east of St. Albans, and its woods were of considerable value. In 1577 another special commission was appointed concerning Her Majesty's park, called Innings, in Bishop's Hatfield, as to the moss which caused the deer to die.¹⁴ The spoils of the woods in the manor of Hatfield formed the subject of a commission of 1591, and in the following year there was a further inquiry relative to the woods of the late priory of Dunstable.¹⁵

Saxton's map of 1577 shows a large number of well-wooded parks in Hertfordshire, and Norden's Survey of 1590 marks about thirty. The latter authority states that: 'This shire at this day is and more hath been heretofore, much replenate with parkes, wooddes and rivers.'

A report on the agriculture of Herts. drawn up in 1795 for the consideration of the Board of Agriculture includes references to the woodlands.¹⁶ It is remarked that

independent of the woodlands contiguous to the seats of gentlemen, nearly the whole county is interspersed with small woods and coppices, and these generally occupy the most barren and gravelly spots, which are well

⁶ *Cart. Mon. de Rames.* (Rolls Ser.), i, 47.

⁷ Stat. 33 Hen. VIII, cap. 39.

⁹ *Ibid.* no. 29.

¹¹ Stat. 35 Hen. VIII, cap. 17.

¹³ Exch. Dep. Spec. Com. Eliz. no. 1020.

¹⁶ *Ibid.* no. 1035, 1036.

⁸ Exch. K. R. Accts. bdl. 148, no. 28.

¹⁰ Brown, *Forests of Engl.* (1883), 225.

¹² Stat. 13 Eliz. cap. 25.

¹⁴ *Ibid.* no. 1026.

¹⁶ D. Walker, *Gen. View of Agric. of Herts.* 68, 70.

FORESTRY

adapted to the quick growth of underwood. The woods are well fenced in, when cut, and preserved from the brett of cattle, and also drained if necessary. As the growth of hop poles is not attended to, the woods are cut in succession about every ten years, and the straight saplings of oak, ash, beech, willow, birch, poplar, hornbeam, or any other woods, either from stub or seed, are preserved till the succeeding fall, and then a due succession of the oak, ash and beech seedlings are preserved; the rest are cut down and split for sheep flakes. Great part of the underwood is hazel, and a conversion of the straight hazel rods into smart hoops for the West India trade would be more to the advantage of the growers than into charcoal and firewood; but this conversion is not much understood or followed in Hertfordshire. A good plant of thriving underwood may be averaged at 20s. per acre per annum.

Mr. Walker also noted that the county possessed a considerable quantity of timber fit for the Navy and inferior shipping, and anticipated that a large supply would be brought to London by the Grand Junction Canal. He had seen naked oak timber recently sold near Berkhamstead, and in the line of the canal, at £3 10s. per load, which would be worth at least £5 10s. at any of the king's or merchants' yards.

A more elaborate report on this county was presented to the Board in 1804 by their secretary, the celebrated Arthur Young; the tenth chapter is devoted to the consideration of woods.¹⁷ It is therein remarked that the woods of Hertfordshire between Hockerill, Ware and Buntingford were generally rented at about 12s. an acre and cut at twelve years' growth, when the produce was about £9 an acre. Fifteen hundred acres of the Marquess of Salisbury, on poorer soil, did not yield more than 7s. an acre. There were then about 2,000 acres of woodland to the south of Hertford towards London. When let to tenants they were cut at nine or ten years' growth, and might be cut twice in a twenty-one years' lease; but they were mostly in the landowners' hands, and were then generally cut every twelve years, when they produced from £4 to £12 an acre; the willow and poplar were used for hurdles and the remainder for faggots.

Any survey of forestry is necessarily concerned with parks, as they are always more or less well timbered. Mr. Harting in an article of the year 1881¹⁸ enumerates thirty-four old parks of the county that have either ceased to exist or are now no longer deer parks. They are as follows: Aspenden, Bedwell, Benington, Berkhamstead, Brockett Hall, Cheshunt, Eastwick, Furneux Pelham, Hadham Parva, Hamells, Hertingfordbury, Hunsdon, King's Langley, New Place (Gilston), Offley Place, Panshanger, Penley Park, Pishobury, Ponsbourne, Roxford, Rye, Sawbridgeworth, St. Albans, Shenley, Stagenhoe, Standon, Theobalds, Thorley, Tyttenhanger, Throcking, Ware, Walkern, Widford and Wyddial. The existing deer parks of the county are ten in number—namely, Ashridge, Cassiobury, Gorbambury, Grove, Hatfield, Knebworth, Moor, Rickmansworth, Tring and Woodhall.¹⁹

Ashridge Park (Earl Brownlow), which is partly in the parish of Little Gaddesden, has an area of 986 acres, and is stocked with about 100 red deer and 300 fallow deer. Within the 5-mile circumference is a considerable stretch of wild and forest-like ground, and there is an abundance of fine timber, chiefly oak, beech and ash. The greater part of this park used to be in Buckinghamshire, but a recent readjustment of county boundaries gives it to Hertfordshire. It was anciently in two divisions, one stocked with fallow and the other with red deer, the latter situated north-west of the house.²⁰ The first park²¹ at Ashridge dates from before the grant of the manor to the college of Ashridge. Large additions were made by the Earl of Bridgewater²² in the 17th century.

Cassiobury Park (the Earl of Essex), in the south-west corner of the county, near Watford, is of considerable size, having an area of 735 acres. The park is divided into two parts, the Home Park and the Upper Park, by the placid stream of the Gade. It is stocked with a herd of about 150 fallow deer. This undulating and picturesque park is splendidly timbered. There are good avenues of limes, much old oak, many well-grown cedars, and some exceptionally fine firs to the north-east of the house. There does not seem to be any mention of this park extant before 1632, but it was probably made by Richard Morrison in the 16th century.²³ Arthur Capell, Earl of Essex, resided there in the time of Charles II on his return from Ireland; he not only rebuilt most of the house, but laid out the gardens and grounds, after the formal style of those at Versailles, and did much planting in the park. Most of the planting was done under the direction of Moses Cook, whose volume on 'Forest Trees,' published in 1676, was dedicated to

¹⁷ A. Young, *Gen. View of Agric. of Herts.* 145–8.

¹⁸ *Trans. Herts. Nat. Hist. Soc.* ii, 97–111.

¹⁹ The short accounts of these parks are taken from Shirley (1867) and Whitaker (1892) *Deerparks*, and from special information and observation.

²⁰ Lipscomb, *Bucks.* iii, 447. The county boundary used to run right through the centre of the house.

²¹ *Cal. Pat.* 1281–92, p. 231.

²² *V.C.H. Herts.* ii, 209 et seq.

²³ *Ibid.* 454.

A HISTORY OF HERTFORDSHIRE

the Earl of Essex.²⁴ In the dedication the writer compliments the earl on the improvements he had effected at Cassiobury: 'To your eternal praise be it spoken there is many a fine tree which you have nursed from seeds sown by your own hands, and many thousands more which you have commanded me to raise. . . . The large plantation you have made will abundantly testify your ability and promptitude in promoting the planting and improving of Forest Trees.' Throughout Moses Cook's book there are various particular references to the woods at Cassiobury that must have been planted more than a century before his time. Thus, when writing of the cherry tree (chap. xvii), he says that the fine and stately trees of the wild cherry are of such a size as to warrant its inclusion among forest trees, and mentions one that had attained to the exact height of 85 ft. 5 in.

'Where they like the ground they make a glorious show in the spring, their white blossoms showing at a distance as though they were clothed with fine white linen; their blossoms are a great relief to the industrious bees at that season.'

In the interesting account given by Evelyn under date of 18 April 1680 of this house and grounds and park occur the following remarks: 'No man has been more industrious than this noble lord in planting about his seate, adorn'd with walks, ponds and other rural elegancies. . . . The land about is exceedingly addicted to wood, but the coldnesse of the place hinders the growth. Black cherry trees prosper even to considerable timber, some being eighty foote long; they make also very handsome avenues. There is a pretty oval at the end of a faire walke, set about with treble rows of Spanish chestnut trees.'²⁵

In the noble large folio volume on Cassiobury Park, issued by John Britton, F.S.A., in 1837, beech is said to predominate amongst the timber, though there was an abundance of fine oak, elm and fir. Particular mention is made of the plantation of firs, north-east of the house, which is said to resemble 'an old Norway forest.' A coloured plate gives representations of a silver and a spruce fir, which had attained to the respective heights of 114 ft. and 120 ft.

Gorhambury Park (Earl of Verulam), 2 miles west of St. Albans, includes about 500 acres, in which there are at present no deer. The park is well wooded with oak and beech. The exact date of the laying out of the park is not known. A plan of the manor of Gorhambury, as surveyed in 1634, shows that the whole estate was then divided into fields.²⁶ A little to the south of the house is the fine old tree, having a girth of 21 ft., known as the Royal or Queen Elizabeth Oak, traditionally associated with the several visits of Queen Elizabeth to Verulam House.

Grove Park (Earl of Clarendon) lies to the north of Watford, and immediately adjoins the park of Cassiobury. It has an area of about 230 acres, and is stocked with about 75 fallow deer. This beautiful park is exceptionally well timbered with a great variety of forest trees and different kinds of conifers.

Hatfield Deer Park (the Marquess of Salisbury) has an area of 530 acres, and is stocked with about 200 fallow deer. The park, as a whole, extends in round figures to 1,500 acres. On this estate there is fresh planting every year; the average for the last ten years is 15 acres per annum. The plantations are mixed, but consist chiefly of oak and ash.²⁷ When Robert Cecil, first Earl of Salisbury, obtained Hatfield from James I in 1607 in exchange for Theobalds, he stocked two parks, one with red and the other with fallow deer.²⁸ These two parks were united by the seventh Earl and first Marquess of Salisbury, who died in 1823. The present park is 7 miles in circumference and the largest in the county; it is beautifully undulating, well timbered, and includes various game coverts. The ancient oak tree under which Queen Elizabeth is said to have been reading when the news of her accession was brought to her is still standing.

Knebworth Park (Earl of Lytton) has now an area of 155½ acres. It was much larger in the early part of last century, three different parts being fenced off containing respectively 30,

²⁴ M. Cook, *The manner of Raising, Ordering and Improving Forest Trees, &c.* Printed for Peter Parker at the Leg and Star . . . Cornhill, 1676. This treatise of upwards of 200 pages is a remarkably good work on arboriculture for the time it was written, and might with advantage be studied at the present day. For instance, in his chapter On Raising and Ordering the Hornbeam, now so rarely planted, he strongly recommends it for parks, 'for a deer will starve before he will so much as taste the bark of the hornbeam.' In the third edition printed in 1724 the author is termed 'Gardiner to the Earl of Essex at Cassiobury.'

²⁵ Evelyn, *Memoirs*, 517. Bird's-eye view of Cassiobury, engraved by Kip, after a drawing by L. Knyff, displays the house with park and gardens, as they appeared about the date of Evelyn's visit, laid out in regular avenues, ovals and circles.

²⁶ Cussans, *Hist. of Herts. Cashio Hund.* 252.

²⁷ From information kindly supplied by the Hatfield Estate Office.

²⁸ Chauncy, *Hist. Antiq. of Herts.* (1700), 308. As to royal sport at Hatfield and Theobalds see *V.C.H. Herts.* i, 346-8.

FORESTRY

40 and 50 acres. The usual number of deer kept in this park for a long time averaged about a hundred, but they have much increased during the last few years; they now (January 1913) number about 200. There have been planted on the Knebworth estate within the last eleven years $8\frac{1}{2}$ acres of poor meadow land and $13\frac{1}{2}$ acres of very poor stiff clay arable land. The trees planted were mostly oak, ash, Scotch fir, larch, spruce and Spanish chestnut.²⁹ This park, which is well timbered and undulating, is not marked on the older surveys of Norden and Saxton, but Chauncy (1700) describes this seat as 'a large pile of brick with a fair quadrangle in the middle of it, upon a dry hill in a fair park, stocked with the best deer in the county, excellent timber and well wooded, and from whence you may behold a most lovely prospect to the east.'³⁰

Moor Park (Lord Ebury), in the parish of Rickmansworth, was imparked as early as the reign of Henry VI,³¹ and apparently enlarged by Cardinal Wolsey,³² but the present inclosed area of 473 acres dates from the time of Charles II. It is stocked with about 150 fallow deer, and is heavily timbered, more particularly with a large number of very old oaks. The large lime tree engraved in Strutt's *Sylva Britannica* (1826) was blown down during a heavy gale in January 1860.³³

Rickmansworth Park (Mrs. Birch), to the north of the town, includes 200 acres, and is stocked with fifty fallow deer. It contains various fine old trees. In a deed of sale of the Fotherley family, dated 7 December 1685, various closes of this estate are stated to be 'now impalled in and lately made a parke.'³⁴

Tring Park (Lord Rothschild) incloses over 225 acres, and is stocked with about eighty head of fallow deer, as well as with kangaroos, emus and rheas. The park stands on high and undulating grounds, and is surrounded by woods which are chiefly of beech.

Woodhall Park (Mr. Abel Henry Smith), in the parish of Watton-at-Stone, incloses an area of 428 acres, including the mansion, gardens and home farm; it is stocked with 150 fallow deer. It is nobly timbered with forest trees, as well as with firs and cedars. There was a park here in Elizabeth's days, as shown in Saxton's survey. The present park was much enlarged and improved at the end of the 18th century.

Of the parks that have disappeared or lost their deer the most famous is that of Theobalds, which lay to the north-east of Enfield Chase. Much has been already said elsewhere of this favourite hunting seat of James I, which need not be here restated.³⁵ The present much reduced park of Theobalds (Sir Hedworth Meux) incloses about 200 acres.

Panshanger Park (Lady Cowper), in Hertingfordbury parish, the most important of the deerless parks, was inclosed by the fifth Earl Cowper in 1801, when the former family mansion at Cole Green was pulled down. The extensive park of close upon 1,000 acres, watered by the River Mimram, includes much splendid timber. To the west of the house stands that singularly grand old tree known as the Panshanger Oak. By a measurement taken in 1719 this tree was found to contain 315 cubic ft. of timber, and Arthur Young in 1804 gave its girth as 17 ft. at a height of 5 ft. from the ground. A further measurement taken in 1805 showed the marvellous vigour of the tree, for it then contained 796 cubic ft., but this second detailed measurement included those branches which were sufficiently large to be considered timber.³⁶ Gilbert White, in his *Natural History of Selborne*, named this tree as 'probably the finest and most stately oak now growing in the south-east of England.' It has now a girth of 21 ft. 4 in. at a height of 6 ft. above the ground.

Hamells Park, in Braughing parish, covers about 200 acres; it is well timbered in parts, and contains some ancient oaks, hornbeams and thorns. The stock of deer died out about 1850.

Tyttenhanger, south of Hatfield, was formerly a deer park of the Abbots of St. Albans; it was disparked at the dissolution of the monasteries.

At Berkhamstead there was an ancient royal deer park attached to the castle, which is mentioned as early as the reign of Edward I and on various subsequent occasions.³⁷ A small portion of the original park of the castle is now attached to Berkhamstead Place.

The ancient deer park at King's Langley was probably formed³⁸ in the 13th century. According to a survey of 1556 it contained a little less than 700 acres. The actual area of Langley Bury Park is now about 220 acres.

The largest of the more modern parks are those of Albury, 500 acres, and Aldenham, 400 acres.

²⁹ From information kindly communicated by Mr. J. Milne, the estate agent.

³⁰ Chauncy, op. cit. 356.

³¹ *V.C.H. Herts.* ii, 375.

³² *L. and P. Hen. VIII*, vi, 426.

³³ Cussans, op. cit. *Cashio Hund.* 129.

³⁴ *Ibid.* 145.

³⁵ *V.C.H. Herts.* i, 346-8.

³⁶ Clutterbuck, *Herts.* ii, 193.

³⁷ Cobb, *Hist. of Berkhamstead* (1883), 18, 22, 28.

³⁸ *V.C.H. Herts.* ii, 237.

A HISTORY OF HERTFORDSHIRE

According to the official agricultural returns there were 22,844 acres of woodland in Hertfordshire in 1891, excepting plantations; 307 acres had been newly planted since 1881, giving a total for the county of 23,151 acres. The woodland returns of the year 1895 show an increase of about 1,400 acres, the total of woods and plantations having risen to 24,543. It is satisfactory to notice that the increased attention given to arboriculture during the past decade shows a further large increase of some 2,000 acres. The latest return (5 June 1905) gives a woodland total for Hertfordshire of 26,568 acres. This total is divided into coppice 8,167, plantations 1,104, and other woods 17,297. Coppice in this return means woods that are cut over periodically and reproduce themselves naturally by stool shoots; plantations mean land planted or replanted within the last ten years.

ECCLESIASTICAL HISTORY

BEFORE THE CONQUEST

THE early ecclesiastical history of the district now known as Hertfordshire centres round the saint and martyr Alban, the influence of whose name still survives in the county. By the beginning of the 3rd century, or perhaps a little earlier, Christianity had penetrated to Gaul, and, considering the relations then existing between that country and Britain, it is probable that it reached this island shortly afterwards. There is no reason to doubt that small bodies of Christians were established in Britain before the middle of the 3rd century,¹ and that Paganism and Christianity for long existed peaceably side by side.

Doubts have been cast by historians upon the existence of Alban,² principally on account of the stories as to his life and martyrdom which grew up at a date when miracles were an essential part of the *passio* of any saint. The probabilities in favour of Alban being an authentic character are, however, strong. The earliest evidence we have of him is in the *Vita Sancti Germani*, compiled about 480 by Constantius³ of Lyons, in which St. German's visit to the tomb of St. Alban in 429 is referred to. It is clear from this and from the reference to Alban in a poem by Venantius Fortunatus of Poitiers, composed at the end of the 6th century,⁴ and from Gaulish legends of the beginning of the 6th century, hereafter referred to, that the story of Alban was well established at an early date, not only in Britain, but in Gaul. Gildas writing in 564 supplies the following account of Alban and his martyrdom :—

Though these precepts (of Christianity)⁵ had a lukewarm reception from the inhabitants, nevertheless they continued unimpaired with some, with others less so, until the nine years⁶ persecution of the tyrant Diocletian. . . . He (God) of His own free gift, in the above-mentioned time of persecution as we conclude (*ut conicimus*)⁷ lest Britain should be completely enveloped in the thick darkness of black night, kindled for us bright lamps of holy martyrs. . . . I speak of St. Alban of Verulam, Aaron and Julius, citizens of Caerlleon, and the rest of both sexes in different places, who stood firm with lofty nobleness of mind in Christ's battle.

¹ Haddan and Stubbs, *Councils and Eccl. Doc.* i, 3, 4, quoting Tertullian (*Adv. Jud.* vii), writing about 208, and Origen (*Hom.* vi in *Luc.* i, 24, and *Hom.* xxviii in *Matt.* xxiv), writing about 239-46 to show that Christianity was in their days established in Britain. See also Williams, *Christianity in Early Brit.* 78 et seq.

² cf. Smith and Wace, *Dict. of Christ. Biog.* under St. Alban; *Biographia Brit.* (ed. A. Kippis, 1778), i, 114.

³ Printed in L. Surius, *De Probatis Sanctorum Historiis* (1570, &c.), iv, 405.

⁴ *De Laude Virginum*, Poem, viii (iv), 155, quoted in Haddan and Stubbs, *op. cit.* i, 6.

⁵ Gildas, *De Excidio Britanniae* (ed. Williams, *Cymmrodorion Rec. Soc.*), i, 23.

⁶ That is from 303 to the Edict of Milan in 312.

⁷ Another text gives *ut cognoscimus*, but Williams considers this merely a gloss (*Gildas, op. cit.* i, 24).

A HISTORY OF HERTFORDSHIRE

The former of these, through love, hid a confessor when pursued by his persecutors, and on the point of being seized, imitating in this Christ laying down His life for the sheep. He first concealed him in his house, and afterwards exchanging garments with him, willingly exposed himself to the danger of being pursued in the clothes of the brother mentioned. Being in this way well pleasing to God, during the time between his holy confession and cruel death, in the presence of the impious men, who carried the Roman standard with hateful haughtiness, he was wonderfully adorned with miraculous signs so that by fervent prayer he opened an unknown way through the bed of the noble River Thames, similar to that dry little-trodden way of the Israelites, when the ark of the covenant stood long on the gravel in the middle of Jordan; accompanied by a thousand men, he walked through with dry foot, the rushing waters on either side hanging like abrupt precipices, and converted first his executioner, as he saw such wonders, from a wolf into a lamb, and caused him together with himself to thirst more deeply for the triumphant palm of martyrdom, and more bravely to seize it.

The narrative given by Bede, writing about 731, comes from another source and is much more detailed than Gildas. He gives an account of the persecution of Diocletian in the eastern empire and of Maximian in the west, 'more lasting and bloody than all the others before it.' 'At length,' he says, 'it reached Britain also, and many persons with the constancy of martyrs died in the confession of their faith.' He continues⁹:

At that time suffered St. Alban. . . This Alban being yet a pagan, at the time when at the bidding of unbelieving rulers all manner of cruelty was practised against the Christians, gave entertainment in his house to a certain clerk, flying from his persecutors. This man he observed to be engaged in continual prayer and watching day and night; when on a sudden the Divine grace shining on him, he began to imitate the example of faith and piety which was set before him, and being gradually instructed by his wholesome admonitions, he cast off the darkness of idolatry, and became a Christian in all sincerity of heart. The aforesaid clerk having been some days entertained by him, it came to the ears of the impious prince that a confessor of Christ, to whom a martyr's place had not yet been assigned, was concealed at Alban's house. Whereupon he sent some soldiers to make a strict search after him. When they came to the martyr's hut, St. Alban presently came forth to the soldiers, instead of his guest and master, in the habit or long coat which he wore and was bound and led before the judge. It happened that the judge, at the time when Alban was carried before him, was standing at the altar, and offering sacrifice to devils. When he saw Alban, being much enraged that he should thus, of his own accord, dare to put himself into the hands of the soldiers, and incur such danger on behalf of the guest whom he had harboured, he commanded him to be dragged to the images of the devils, before which he stood, saying, 'Because you have chosen to conceal a rebellious and sacrilegious man, rather than to deliver him up to the soldiers, that his contempt of the gods might meet with the penalty due to such blasphemy, you shall undergo all the punishment that was due to him, if you seek to abandon the worship of our religion.' But St. Alban, who had voluntarily declared himself a Christian to the persecutors of the faith, was not at all daunted by the prince's threats, but putting on the armour of spiritual warfare, publicly declared that he would not obey his command. Then said the judge, 'Of what family or race are you?' 'What does it concern you,' answered Alban, 'of what stock I am? If you desire to hear the truth of my religion, be it known to you that I am now a Christian and free to fulfil Christian duties.' 'I ask your name,' said the judge, 'tell me it immediately.' 'I am called Alban by my parents,' replied he, 'and I worship ever and adore the true and living God, Who created all things.' Then the judge, filled with anger, said, 'If you would enjoy the happiness of eternal life, do not delay to offer sacrifice to the great gods.' Alban rejoined, 'These sacrifices, which by you are offered to devils, neither can avail the worshippers, nor fulfil the desires and petitions of the suppliants. Rather, whosoever shall offer sacrifice to these images, shall receive the everlasting pains of hell for his reward.'

The judge, hearing these words, and being much incensed, ordered this holy confessor of God to be scourged by the executioners, believing that he might by stripes shake that constancy of heart, on which he could not prevail by words. He, being most cruelly tortured, bore the same patiently, or rather joyfully, for our Lord's sake. When the judge perceived that he was not to be overcome by tortures, or withdrawn from the exercise of the Christian religion, he ordered him to be put to death. Being led to execution he came to a river, which with a most rapid course ran between the wall of the town and the arena where he was to be executed. He there saw a great multitude of persons of both sexes, and of divers ages and conditions, who were doubtless assembled by Divine inspiration, to attend the blessed confessor and martyr, and

⁹ A name was not given to the confessor sheltered by Alban till Geoffrey of Monmouth wrote his *Historia Britonum* in the middle of the 12th century. Archbishop Ussher and others suggest that the name Amphibalus given to the converter of St. Alban was an alternative word for *caracalla*, the garment which Bede states Alban put on to impersonate his guest (cf. also *Epistola Gildae*, A.D. 547, printed by Haddan and Stubbs, op. cit. 49, l. 11, and note 54, where two readings are given, one showing the use of the word Amphibalus as a cloak, and the other less authentic as a Christian name). A few years after Geoffrey of Monmouth compiled his history a barrow was opened at Redbourn in 1178, which from the minute description of its contents was clearly a pagan Saxon burial. Abbot Simon, however, desiring to add glory to his church assigned the bones to the newly invented saint whose life was composed to suit the occasion (T. Wright, *Essays on Arch.* i, 285).

⁹ Bede, *Hist. Eccl.* (transl. A. M. Sellar), 14.

ECCLESIASTICAL HISTORY

had so filled the bridge over the river that he could scarce pass over that evening. In truth, almost all had gone out, so that the judge remained in the city without attendance. St. Alban, therefore, urged by an ardent and devout wish to attain the sooner to martyrdom, drew near to the stream, and lifted up his eyes to heaven, whereupon the channel was immediately dried up, and he perceived that the water had given place and made way for him to pass. Among the rest, the executioner, who should have put him to death, observed this, and moved doubtless by Divine inspiration hastened to meet him at the appointed place of execution, and casting away the sword which he had carried ready drawn, fell at his feet, praying earnestly that he might rather be accounted worthy to suffer with the martyr whom he was ordered to execute, or, if possible, instead of him.

Whilst he was thus changed from a persecutor into a companion in the faith and truth, and the other executioners rightly hesitated to take up the sword which was lying on the ground, the holy confessor, accompanied by the multitude, ascended a hill, about half a mile from the arena, beautiful, as was fitting, and of most pleasing appearance, adorned, or rather clothed, everywhere with flowers of many colours, nowhere steep or precipitous or of sheer descent, but with a long, smooth natural slope, like a plain, on its sides, a place altogether worthy from of old, by reason of its native beauty, to be consecrated by the blood of a blessed martyr. On the top of this hill St. Alban prayed that God would give him water, and immediately a living spring, confined in its channel, sprang up at his feet, so that all men acknowledged that even the stream had yielded its service to the martyr. For it was impossible that the martyr, who had left no water remaining in the river, should desire it on the top of the hill, unless he thought it fitting. The river then having done service and fulfilled the pious duty, returned to its natural course, leaving a testimony of its obedience. Here, therefore, the head of the undaunted martyr was struck off, and here he received the crown of life, which God has promised to them that love Him. But he who laid impious hands on the holy man's neck was not permitted to rejoice over his dead body; for his eyes dropped upon the ground at the same moment as the blessed martyr's head fell.

At the same time was also beheaded the soldier who before, through the Divine admonition, refused to strike the holy confessor. Of whom it is apparent that, though he was not purified by the waters of baptism, yet he was cleansed by the washing of his own blood, and rendered worthy to enter the kingdom of heaven. Then the judge, astonished at the unwonted sight of so many heavenly miracles, ordered the persecution to cease immediately, and began to honour the death of the saints, by which he once thought that they might have been turned from their zeal for the Christian faith. The blessed Alban suffered death on the twenty-second day of June, near the city of Verulam, which is now by the English nation called Verlamacaestir, or Vaeclingacaestir, where afterwards, when peaceable Christian times were restored, a church of wonderful workmanship, and altogether worthy to commemorate his martyrdom, was erected. In which place the cure of sick persons and the frequent working of wonders cease not to this day.

It is obvious that these narratives are taken from different sources. That of Gildas lacks all the detail given by Bede, which has been traced to a foreign origin.¹⁰ It may perhaps be suggested that as the early British legends were not so much given to the miraculous as those of the Continent, Gildas may have drawn his information from some British legend then surviving in Wales or Brittany.¹¹

The interesting discoveries of Professor W. Meyer have lately thrown considerable light upon the sources of Bede's account of St. Alban.¹² He clearly shows that Bede drew his narrative almost word for word from a *passio*, of which a 9th or 10th-century copy is preserved at Paris, and this is again drawn with variations in details from an earlier *passio*, of which an 8th-century copy is now at Turin. He further shows that these two *passiones* were compiled, as regards details, from excerpts taken from lives of other saints, a practice common at the time. By means of these borrowed sources he is able to prove that the date of the original compilation of the Turin *passio* was between 500 and 540, and that it came from mid-Gaul. He suggests that German brought the legend to Auxerre, where, after his return from Britain, he built a church in honour of St. Alban, and that the life of German, written by Constantius about 480, stimulated the compilation of the *passio*.¹³

¹⁰ W. Meyer, *Die Legende des H. Albanus des Protomartyr Angliae in Texten vor Beda*, 22.

¹¹ Dr. Williams calls attention to the fact that the miracle of Alban crossing the river on dry ground is the only miraculous incident introduced by Gildas into the *De Excidio* (op. cit. 103, 106).

¹² W. Meyer, op. cit. *passim*.

¹³ The confusion in the Turin text as to the person that tried Alban and authorized his execution, who is called indifferently *Caesar* and *judex*, points to its having been compiled from still earlier texts. This same person in the Paris text and Bede is named indifferently *princeps* and *judex*.

A HISTORY OF HERTFORDSHIRE

The two points upon which there has long been dispute are the date and place of the martyrdom. The dates which have been suggested vary between 208 and 305. The Turin *passio* gives the period as the time of the Emperor Severus, before whom the trial of Alban is laid,¹⁴ which would therefore be during the stay of Severus in Britain between 208 and his death at York in 211. This date, however, is discredited by Meyer as being the invention of a Frenchman who prefaces the account of the *passio* of St. Alban with the story of the persecution of Severus at Lyons and Aachen, which occurs in no other legend of this saint.¹⁵ Dr. Williams in *Christianity in Early Britain* urges strongly that Alban suffered either under the seventh persecution of Decius, which began in 250 and probably continued till 253, or the eighth, under Aurelian, which lasted from 257 till the relaxation of Gallienus in 260. He points out that Gildas only conjectured that Alban suffered under the persecution of Diocletian and upon the evidence of Eusebius and Lactantius, he contends that the persecution never reached Britain.¹⁶ There seems to be little warrant for the date 286¹⁷ that has been accepted by some. At this date, so far as it is known, there is no evidence of persecution in Britain, which was then in a disturbed condition owing to the usurpation by Carausius. The adoption of this date probably originated through an error of the compilers of the Anglo-Saxon Chronicle, who base their story upon Bede's Ecclesiastical History where book i, cap. 6, begins with the accession of Diocletian in this year and deals with events of his reign, including the persecution, and cap. 7 gives the account of the martyrdom in the time of the persecution without intervening date.

The generally accepted time, and that suggested, if not asserted, by Gildas, adopted by Bede, and implied by the Paris *passio*, is the persecution of Diocletian. The first edict for this was issued at Nicomedia, about March 303. It ordered the destruction of all churches and the burning of all copies of the Scriptures. Christians in honourable positions were to be degraded and Christian freedmen were to be deprived of their liberty. This edict was followed by others, under the last of which a general persecution was proclaimed against the Christians.¹⁸ The persecution lasted till the abdication of Diocletian on 1 May 305, and seems to have been carried out with the utmost severity in the eastern parts of the Empire, where according to Eusebius great numbers suffered martyrdom. In the west, however, where Spain, Gaul and Britain were under the mild rule of Constantius Chlorus, we learn from Eusebius and Lactantius that persecution was less rigorous. Constantius, although not a Christian, was favourably inclined to the Church, and is said to have protected its members.¹⁹ Lactantius states that Constantius destroyed the Christian churches, but preserved intact the true temple

¹⁴ W. Meyer, *op. cit.* 35, 46.

¹⁵ *Ibid.* 18. The Turin text, as Professor Meyer points out, has some connexion with Lyons and was compiled by a Gallic scribe, for it is prefaced by an account of the persecution under Severus there. It is possible there may have been some confusion with the general Albinus, who usurped the authority of Severus for three years in Britain, and was beheaded at Lyons in 197 after the rout of his British army there.

¹⁶ Williams, *op. cit.* 101, 102, 109, 111, 114, 115.

¹⁷ See Williams as above, citing Tillemont, *Hist. des Empereurs*, iv, 508; Allard, *La Persecution de Diocletien*, 40, 41; Görres, *Zeitschrift für Wissenschaft. Theologie*, 1888, xxxi, 83. See also Ussher, *Primordia*, cap. vii, p. 174.

¹⁸ Eusebius, *Ecc. Hist.* bk. viii, cap. 2. Alban, it is supposed, was a priest.

¹⁹ *Ibid.* cap. 13. Sozomen, *Hist. Eccl.* bk. i, cap. 6. Sozomen only conjectures that there was no persecution in Gaul, Britain and Spain.

ECCLESIASTICAL HISTORY

of God, which is man.'²⁰ Eusebius goes further and says that he did not destroy the churches or devise any mischief against the Christians, and that Christians of the Western Empire at this time enjoyed peace.²¹

There is much to be said for Dr. Williams's arguments in favour of the date of the martyrdom being in the period of persecution under Decius or that under Valerian. At the same time, it must be remembered that Eusebius and Lactantius, upon whom he relies, were historians of the Church in the Eastern Empire, who dwelt in Asia and Africa, and could have had little or no knowledge of what was taking place in Gaul or Britain. Constantius was much away from Britain. It is true he died at York in July 306, but he had only arrived in Britain at the beginning of the year.²² There is evidence, however, that in Spain, which was equally under the rule of Constantius, there was persecution at this time by the local governor Dacianus, and that St. Vincent there suffered martyrdom.²³ It is conceivable, therefore, that during the absence of Constantius on the Continent in 304 or 305 there may have been a slight persecution in Britain. Its slightness may perhaps account for the prominence which Alban's name has maintained, and it would seem that he, and possibly Aaron and Julius, were the only martyrs who suffered at the time in Britain. Had there been more their names would have been preserved to us, for martyrs were held in high estimation in the early Church. The evidence of Gildas, probably relying upon an earlier *passio*, and the statement of Bede cannot be lightly discarded in favour of somewhat vague and negative evidence of historians nearer in date but far distant in locality, and consequently in direct knowledge of the facts.

With regard to the place of the martyrdom, as to which question has been raised,²⁴ Gildas describes Alban as of Verulamium, but gives the name of the river he crossed on the way to execution as the Thames. This, however, is a pardonable error for one who was probably entirely ignorant of eastern Britain, and to whom the name of the Thames was more familiar than that of its tributary the Ver. Bede definitely states that the martyrdom occurred at Verulamium. Whoever originally compiled the topographical details of the *passio*, from which the stories in the Turin and Paris texts and Bede were taken (for they are almost word for word the same) must have known Verulamium and the site of the martyrdom where St. Albans Abbey now stands, and had them in his mind when he wrote the *passio*. Anyone acquainted with the neighbourhood of St. Albans cannot fail to be struck with the accuracy of his description²⁵: the river (the Ver) outside the walls of the Roman town and spanned by a bridge, probably on the site of the present St. Michael's Bridge, which carried the Roman road to Colchester; the approach to the place of execution about 500 paces or half a mile distant up a gentle incline to the summit of the hill, and the view from the hill, 'sloping down to a beautiful plain,' can even now be enjoyed at the time of the commemoration of the saint's martyrdom in June. This description is carried back by Professor Meyer to the beginning of the 6th century, some fifty

²⁰ 'De Morte Persecutorum,' 15, 6.

²¹ Eusebius, loc. cit. See also the Appendix to bk. viii; 'The Martyrs of Palestine,' cap. 13.

²² Williams, op. cit. 115, citing Panegyricus, vii; Eusebius, Vita Constantini, i, 21, and other sources.

²³ Prudentius, Peristephanon, Hymn v; *Acta Sanctorum* (ed. Bollandist), iii, 7; Gibbon, *Decline and Fall of the Roman Empire*, cap. xvi.

²⁴ Williams, op. cit. 103.

²⁵ The rapidity of the Ver is the only point of inaccuracy, and this may be poetic licence.

A HISTORY OF HERTFORDSHIRE

years before the time of Gildas. It seems, therefore, likely that it formed a part of the legend which was carried back by those who accompanied St. German to Britain in 429 and saw the spot themselves. The existence of a church built by the early Celtic Christians on the site of the martyrdom is hinted at by Gildas, and Bede states that it was standing in his day (731), when miracles were performed there. The tradition persisted at the end of the 8th century, when Offa founded the monastery of St. Alban, and so the abbey has kept it alive to this day. There seems no reason, therefore, to doubt the tradition which connects St. Alban with Verulamium.²⁶

After the accession of Constantine the Great in 306, persecutions ceased in the West and Christianity appears to have spread rapidly in Britain. The Church became organized under bishops, three of whom, York, London and probably Lincoln, attended the Council of Arles in 314. Professor Zimmer places a Celtic bishopric at Verulamium,²⁷ but there is no evidence of such a see, although the importance of the town, the tradition of the martyr Alban, and the existence of an early Christian Church would well adapt it for a centre of ecclesiastical organization.

As the connexion between Britain and Rome relaxed at the beginning of the 5th century the isolated position of the country caused the British Church to become liable to the influence of heretical doctrines. It is said to have been tainted with Arianism,²⁸ and about 422 the heresy of Pelagius, a Briton, was introduced by his disciple Agricola.²⁹ Pelagius denied the doctrine of original sin and asserted the power of free will, whereby a man was in himself enabled 'to sin or not to sin,' thus bringing into question the foundation of the doctrine of grace.³⁰ The number of Pelagians quickly increased in Britain, so that the orthodox members of the Church had to appeal to the Continent for assistance to refute the heresy. According to one story, which is perhaps the more probable, at the intercession of Palladius, afterwards, as it is said, the first bishop in Ireland, Pope Celestine in 429 sent German or Garmon, Bishop of Auxerre, to Britain to confute the heretics.³¹ According to another narrative the British Church sent to the Gallic bishops for aid, and a council³² was called at which German and Lupus Bishop of Troyes were selected to go to Britain.³³ In either case German and Lupus came to Britain to preach the orthodox faith throughout the country, and at a place not named, a great multitude of people being brought together with their wives and children, the bishops with much eloquence entirely confounded the Pelagians.³⁴ When the disputation was over, after curing a girl of her blindness, the bishops hastened to the tomb of St. Alban, in which German deposited relics of all the apostles and divers martyrs and took away some of the earth still, as it is asserted, stained with the blood of the saint.

²⁶ Rev. A. W. Wade-Evans is anxious to attach Alban to Wales, and suggests that the site of the martyrdom was at Mount St. Alban, about 2 miles from Caerleon on Usk. His arguments are ingenious but not convincing, and he wishes to rely upon the discredited authority of Geoffrey of Monmouth ('Site of St. Alban's Martyrdom,' *Arch. Camb.* [Ser. 6], v, 256 et seq.).

²⁷ Zimmer, *The Celtic Church in Brit.* (translated by A. Meyer), 58. He calls the seat of the bishopric St. Albans, obviously an error.

²⁸ Zimmer, *op. cit.* 5, quoting Gildas.

²⁹ Haddan and Stubbs, *op. cit.* i, 15, quoting Prosper of Aquitaine.

³⁰ The doctrine of the Pelagians is still disputed in the Ninth Article of the Thirty-nine Articles.

³¹ 'Chron. of Prosper,' *Gallia Christ.* xii, 263; Haddan and Stubbs, *op. cit.* i, 16.

³² Nothing is known of this council, and grave doubts are entertained as to its having been held.

³³ Constantius, 'Vita Sancti Germani,' cap. xix (*De Probatis Sanctorum Historiis*, iv, 416); Haddan and Stubbs, *loc. cit.*

³⁴ *Ibid.*

ECCLESIASTICAL HISTORY

Bede in narrating this incident cites Constantius,³⁵ and does not mention any locality, but Matthew Paris, quoting Bede, adds a gloss to the effect that the disputation, or synod, as he calls it, was at Verulamium.³⁶ Assuming, as it is here contended, that the martyrdom of St. Alban was at Verulamium, the tomb and blood-stained earth were there and consequently the disputation must also have taken place there, besides which there has been a local tradition to this effect from mediaeval days, a hermitage and chapel being successively built on the supposed site of the disputation and a piece of the Roman wall still bears the name of St. German's Block.

The introduction of monasticism into Britain has been attributed with some probability to St. German and Lupus on the occasion³⁷ of this visit. So far as is known there were no monks or monasteries here till after the first quarter of the 5th century. Before that date the Church consisted only of missionary communities, each being ruled by a bishop, under whom were priests and deacons. The only churches were the bishops' churches and the only priests were those who served in them.³⁸ It may be, therefore, that the church built at Verulamium on the site of the martyrdom was one of these churches. But Celtic enthusiasm took keenly to monachism, and monasteries sprang up in the 5th century throughout the land, soon becoming the centres of ecclesiastical organization and learning.

The greater part of the 5th and all the 6th century are entirely blank as regards the history of the Church in the district now known as Hertfordshire. Whether the story of the fall of Verulamium³⁹ about 512 contains even a grain of truth is very doubtful, but with the abandonment of that town Christianity probably disappeared from the west of the county, which became depopulated and reverted to the condition of forest land. Watling Street probably continued as a line of communication, and so the little church on the site of the martyrdom of St. Alban, which was near it, may have been visited by travellers and its tradition preserved. The eastern parts of the county had succumbed to the pagan Saxon earlier. Indeed, so completely were the Celtic inhabitants wiped out of this district that probably not a town nor a village exists in the county that bears a Celtic name.

The eastern side of what was later the county became a part of the kingdom of the East Saxons, whose king, Saeberth, was converted to Christianity early in the 7th century.⁴⁰ In 604 St. Augustine consecrated Mellitus as their first bishop with his see at London.⁴¹ Some twelve years later, however, after the death of Saeberth, his sons caused the people to relapse into paganism and Mellitus retired into Gaul.

The East Saxons continued to be heathens till 654, when their king, Sigeberth, became a Christian, and his people were reconverted by the saintly Cedd, brother of St. Chad. Cedd was then only a priest, but was shortly afterwards consecrated bishop of the East Saxons.⁴² The monasteries at Tilbury and at the Roman town of Othona or Ythanceaster, the site of which is now under the sea, were his missionary stations, from which he sent out his priests and deacons to preach to and baptize the people. He also built

³⁵ Bede, *Hist. Eccl.* bk. i, cap. 17.

³⁶ Matt. Paris, *Chron. Maj.* (Rolls Ser.), i, 186.

³⁷ Williams, *op. cit.* 260; Dom Louis Gougaud, *Les Chrétientés Celtiques*, 65, 346.

³⁸ Williams, *op. cit.* 456.

³⁹ Geoffrey of Monmouth, *Hist. Brit.* bk. viii, cap. 23, 24.

⁴⁰ Bede, *Hist. Eccl.* bk. ii, cap. 3.

⁴¹ *Ibid.* cap. 5.

⁴² *Ibid.* bk. iii, cap. 22.

A HISTORY OF HERTFORDSHIRE

churches, probably in the nature of oratories or chapels dependent upon the larger monasteries, for ministering the rites of religion.⁴³ There was again a relapse into heathenism by some of the East Saxons, probably in the western parts, including Hertfordshire, which were removed from the influence of Cedd's ministrations, when the plague swept over the land between 664 and 666. Those who relapsed, however, were brought back to Christianity very shortly afterwards by Bishop Jaruman of Lichfield.⁴⁴

The see of the bishops of the East Saxons was not restored to London till 666,⁴⁵ when Wine is said to have bought the bishopric from Wulfhere, King of Mercia, then overlord of the East Saxon kingdom. It is to Wine's successor Earconwald, consecrated in 675, that the reorganization of the East Saxon diocese is due. The church of St. Paul became the centre of ecclesiastical activity on the western side of the diocese, and it was from it that the parts of the diocese in the county of Hertford were served.

Theodore, who was consecrated Archbishop of Canterbury in 668, attempted to improve the organization of the Church, and for this purpose introduced the meeting of canonical synods. The first of these was held at 'Heorutford' or 'Herutford,' on 24 September 673.⁴⁶ It treated of the date of Easter, the distinction of bishoprics, the exemption of monasteries from episcopal jurisdiction, the duties of monks, clergy and bishops when away from their own districts, the holding of synods, the precedence of bishops, the increase of dioceses and marriage and divorce. The place of this synod has usually been identified with Hertford in Hertfordshire, but Hertford does not undoubtedly appear in history for some 240 years later under circumstances which may suggest its foundation at that date.⁴⁷ The council was held before Theodore Archbishop of Canterbury and Bisi Bishop of the East Angles, with whom also were Wilfrid Bishop of the Northumbrians (by proxy), Putta Bishop of Rochester, Leutherius Bishop of the West Saxons, and Wynfrid Bishop of the Mercians, each one sitting according to his order. Theodore as metropolitan would naturally preside, but Bisi, who is mentioned with Theodore and separate from the other bishops, is taken out of his order of precedence⁴⁸ of consecration. The inference is that the council was held in Bisi's East Anglian diocese of Dunwich, when he would naturally take precedence after the archbishop.⁴⁹ Wine Bishop of London, in whose diocese Hertford in Hertfordshire probably lay, was not present at the council.

The next important council in England was in 680 and dealt with the orthodoxy of the English Church. It was held under the presidency of Archbishop Theodore at 'Haethfeld,' which has usually been identified with Hatfield in Hertfordshire. In a decree, however, said to have been issued at the same time dividing the country into the two provinces of Canterbury and York, which formed a part of the arrangement with Wilfrid as to the sub-

⁴³ Bede, *Hist. Eccl.* bk. iii, cap. 22.

⁴⁴ *Ibid.* cap. 30.

⁴⁵ *Ibid.* cap. 7.

⁴⁶ Haddan and Stubbs, *op. cit.* iii, 118.

⁴⁷ *V.C.H. Herts.* iii, 492.

⁴⁸ Wilfrid, and possibly Putta, were of earlier consecration. The order of consecration was the order determined at this council.

⁴⁹ See *V.C.H. Herts.* loc. cit. Miss A. Raven suggests that possibly the identification of 'Heorutford' may be Hartford near the Ouse, about 2 miles from Huntingdon and Ermine Street, which was apparently at the time of the council in the diocese of Dunwich (Geoff. Hill, *The English Dioceses*, 63). In 1086 it was ancient demesne of the Crown, and a place of importance at which there were two churches and a priest (Dom. Bk.).

ECCLESIASTICAL HISTORY

division of the latter diocese, Egfrith King of Northumbria, who was present, preceded the Kings of Mercia, East Anglia and Kent in giving his consent. It would therefore seem that 'Haethfeld' can with more probability be identified with Hatfield in Yorkshire, in the kingdom of Northumbria and diocese of York.⁵⁰

Of the western and southern parts of the county we hear little or nothing till the end of the 8th century, when they formed part of the kingdom of Mercia. They were forest land which could have supported few families and like other great areas of waste were largely granted to religious bodies for settlement. The greater part was given to St. Albans Abbey at its foundation in 793, and Ely and Westminster afterwards received large tracts. The settlement of the district was probably late, for we know that the clearance of it continued into the 12th and 13th centuries and possibly later. Such inhabitants as there were would obtain the ministrations of religion from the monks of St. Albans Abbey. But this monastery cannot have ministered to the whole county before the introduction of the parochial system in the 10th and 11th centuries. There must have been other smaller communities of priests to supply religious service in the districts distant from St. Albans, whose existence has long been lost. These small monasteries or minsters of priests, being impoverished by the Danish invasions and discountenanced and suppressed by Æthelwold, Oswald and Dunstan, in their endeavours to establish the stricter Benedictine rule, possibly became mother churches, the *matrices ecclesiae parochiales* mentioned in the laws of William the Conqueror, retaining in many cases their title of minster. We have perhaps some evidence of this development at Braughing and Welwyn and possibly at Hitchin. With regard to the two former places it would appear that in 944-6 Ethelgiva left her land at Munden to Ealfwold for life, subject to the yearly payment to each of the minsters (*monasteria*) of Braughing and Welwyn of six bushels (*modios*) of barley together with flour and fish at Lent and four pigs at the feast of St. Martin, and at his death the land was to be divided between the two minsters.⁵¹

Such bequests as these would seem more appropriate to communities or small minsters than to single parish priests, besides which all these places lay on important roads, a matter so essential to early monasteries on account of the periodical attendance at them of the people of the district. Braughing was at the intersection of several Roman roads, almost on the site of a Roman station; it was the head of the deanery of Braughing, which comprised all the lands in Hertfordshire that lay in the diocese of London, and thus its church was one of importance. It had always been held in alms of the king and supported a priest in 1086.⁵² Welwyn was at a ford on a Roman road and had been an important Late Celtic and Roman settlement. The priest there in the time of Edward the Confessor and probably long before held the manor in alms of the king, and the rector still holds it. It was also the head of a later deanery. Hitchin lay on an important early road and the church is described in the Domesday Survey as a minster

⁵⁰ cf. Hardy, *Monumenta Hist. Brit.* i, 227 with variants. A council was held at 'Bergamysted' in 696 to treat of ecclesiastical matters connected with Kent. This place has been identified with Berkhamstead in Hertfordshire, but the probable identification is Bearsted near Maidstone (Haddan and Stubbs, *op. cit.* iii, 233, 238 n.).

⁵¹ Birch, *Cart. Sax.* ii, 571.

⁵² *V.C.H. Herts.* i, 322.

A HISTORY OF HERTFORDSHIRE

(*monasterium*), being also endowed with the unusually large glebe of 2 hides. It was likewise the head of an early deanery, and was the mother church of a large district including Great Wymondley, Little Wymondley and Ippollitts. The endowments of both Welwyn and Hitchin suggest that their original foundations were for establishments larger than manorial churches, and this, coupled with the fact that these churches are described in the 10th and 11th centuries as minsters, points possibly to the existence of communities of priests at them before the introduction of the parochial system into the county.

The Danish invasions of the 9th and 10th centuries had probably dislocated ecclesiastical organization. In France and other parts of the Continent the modern parochial system had been for some time adopted,⁵³ partly as a consequence of the reforms then being carried out in the Benedictine monasteries. It was naturally found that the restriction of the monks to the cloister hampered their ministrations to the people. Oswald and Dunstan had seen the modern parochial system at work in France and recognized its advantages with regard to their scheme of ecclesiastical reform at home. The earliest evidence of its introduction into Hertfordshire arose apparently out of the reforms at St. Albans Abbey. Here the imposition of a stricter rule and the increasing population of the recently established market town at St. Albans necessitated other accommodation for the lay folk of the neighbourhood. As a result in the latter part of the 10th century the abbot built the churches of St. Peter, St. Michael, and St. Stephen⁵⁴ on the main roads on the outskirts of the town of St. Albans. These churches were probably served from the abbey, and had no separate glebe, consequently their priests are not mentioned in the Domesday Book. St. Peter's ministered to the district on the north and north-east of the abbey, St. Stephen's to that on the south and south-east, probably to the county boundary, and St. Michael's to that on the west and south-west to the county boundary. These churches seem to have been mother churches, and their districts were gradually subdivided, St. Peter's with the later chapelries of Sandridge (where the chapel was consecrated about 1100), Ridge and Northaw remained as it was originally formed till the 14th century, when the chapelries became parishes. St. Stephen's and St. Michael's districts from architectural evidence were possibly subdivided during the 12th century.⁵⁵

The same process went on perhaps a little later in other parts of the county. The Saxon thegns and Norman lords were in the 10th and 11th centuries building churches on their demesnes adjoining their houses.⁵⁶ In the eastern and middle parts of the county the church next the manor-house is the usual type of development,⁵⁷ while in the west on the lands of

⁵³ Lord Selborne, *Ancient Facts and Fancies concerning Churches and Tithes*, 60.

⁵⁴ Matt. Paris, *Gesta Abbat.* (Rolls Ser.), i, 22. See below, p. 369, n. 32.

⁵⁵ Abbots Langley, Sarratt, East Barnet and Watford have 12th-century churches. We have definite evidence that Bushey Church was built by Geoffrey de Jarpenville about 1166. Except in the case of Bushey there may have been early churches which were rebuilt in the 12th century, but it is quite likely in this late settled district that the churches now standing are the earliest which were built on the sites.

⁵⁶ Selborne, *op. cit.* 293.

⁵⁷ Some notable instances are at Hatfield, where the church adjoins the remains of the old palace of the Bishops of Ely; at Pirton, Benington and Anstey, where the churches were probably within the earthworks of the Norman castles; at Bygrave, Wallington, Reed, Barkway, Hormead, Meesden, Cottered, Aspenden, Sacombe, Much Hadham, Thundridge, Hunsdon, Thorley and other places where the churches adjoin the manor-houses or the sites of such houses. At Stevenage, Digswell, North Mimms and elsewhere the villages have migrated to the roads and left the churches and manor-houses standing alone.

ECCLESIASTICAL HISTORY

St. Albans Abbey and Westminster Abbey, where there were no resident lords, it is the exception.

The Domesday Survey affords evidence of the adoption of the parochial system in Hertfordshire. It may perhaps be assumed that an entry of a priest in the Domesday Book usually among the tenants of the demesne generally implies the existence of a manorial church endowed with glebe.⁶⁸ To understand the references to priests in the Hertfordshire Domesday comparison must be made with the fuller entries of the same nature which will be found under Essex. There the formula as to the priest is usually 'then as now' a priest was holding, 'then' in this formula carrying the conditions back to the time of Edward the Confessor. In the shortened form of the Hertfordshire text only the conditions of the time of the Survey (1086) as regards priests are as a rule given; but it is evident that the existence of the priest went back to the earlier date, for, if a reconstruction of the holdings at the time of Edward the Confessor be made, it can be shown that most of the resident thegns or other tenants⁶⁹ provided for priests on their demesnes at the places where they lived. Thus Æthelmar of Benington, a thegn of King Edward, had lands at Benington, Sacombe, Layston, Ashwell, Hinxworth, Radwell and Bengeo, but there was only a priest on his lands at Benington⁶⁰ where we know he lived, and a clerk is mentioned on his land at Sacombe; Wlwin of Eastwick, a thegn of Earl Harold, had lands at Hailey and Eastwick, but it was on his land at Eastwick where he lived that we find a priest⁶¹; Anschil of Ware had lands at Ware and Knebworth, but it was on his lands at Ware where he resided that there was a priest⁶²; Osulf son of Frane had lands at Tring and Studham, but it was on his land at Studham where he lived,⁶³ and where we know that he and his wife built a church in 1064,⁶⁴ that a priest is mentioned; Alwin Horne, a thegn of King Edward, had lands at Watton, Walkern and Sacombe, but there was only a priest on his lands at Walkern where he probably lived.⁶⁵ In the same way other tenants provided land for a priest at one of their holdings, presumably where they lived, as, for instance, Aldred, a thegn of King Edward, who had lands at Widford, Layston and Aspenden, but there was a priest only on his lands at Aspenden⁶⁶; Ælfric Blac, a man of Archbishop Stigand, who had lands at Watton, Shephall, Libury in Little Munden, Sacombe, Langport and Throcking, but it was only on his lands at Watton that there was a priest⁶⁷; Alward, a man of the same archbishop, who had lands at Widford, Meesden and Libury, but it was only on his lands at Meesden that there was a priest⁶⁸; Wulfward, a man of Asgar the Staller, held lands at Hormead and Wormley with a priest on his lands at Hormead.⁶⁹ Some who held only one manor had provided a priest, such as Anand, the houscarl of King Edward at Bengeo,⁷⁰ or Sait, a man of Earl Lewin at Buckland.⁷¹ The cases, however, of Alward, a thegn of Earl Harold, who had

⁶⁸ It must not, however, be thought that the absence of a reference to a priest indicates that there was no church, as provision may have been made for the incumbent in some other way than by the endowment of glebe, or the church may have been served from a monastery (see Round, in *V.C.H. Berks.* i, 300).

⁶⁹ There were a good many landowners who were non-resident besides ecclesiastics; such, we may presume, was Alestan of Boscombe. ⁶⁰ *V.C.H. Herts.* i, 336-8. ⁶¹ *Ibid.* 335. ⁶² *Ibid.* 327, 328.

⁶³ *Ibid.* 324, 325. ⁶⁴ Thorpe, *Dipl. Angl.* 374. ⁶⁵ *V.C.H. Herts.* i, 342. ⁶⁶ *Ibid.* 306, 329.

⁶⁷ *Ibid.* 305, 320, 321.

⁶⁸ *Ibid.* 306, 307, 309.

⁶⁹ *Ibid.* 322, 342.

⁷⁰ *Ibid.* 334.

⁷¹ *Ibid.* 310.

A HISTORY OF HERTFORDSHIRE

priests on his lands at Anstey and Barksdon in Aspenden,⁷³ and had lands also at Layston and Wakeley; Lemar, a man of Archbishop Stigand, who had priests on his lands at Bygrave and Caldecot, and had lands also at 'Hamstone' and Graveley,⁷³ and some others would tend to show possibly that there was beginning to be a rearrangement of estates. The evidence, however, of the existence of a priest on one holding only of a thegn or other tenant, presumably his residence, is so regular that the system of building and endowing manorial churches by such Hertfordshire thegns and others on their demesnes cannot have been in force for very long before the time of Edward the Confessor. The only date for the building of a pre-Conquest manorial church by a layman in Hertfordshire is that for Studham in 1064, but the architectural details of the churches at Northchurch, Walkern, Westmill, Little Munden and Reed suggest a date of building some thirty or forty years earlier. It is, therefore, safe to suppose that the system of the erection and endowment of manorial churches by thegns and others began in the county towards the end of the 10th century and was most active in the 11th and 12th centuries.

We may perhaps see something of what Professor Maitland refers to as 'the communal action' in the ownership, and consequently in the erection and endowment of churches on the holdings of the sokemen of Hertfordshire.⁷⁴ At Boreson in Little Hormead,⁷⁵ and at Wyddial,⁷⁶ which were each held in the time of Edward the Confessor by nine sokemen, and at Barley,⁷⁷ which was then held by five sokemen, there were priests, and therefore apparently churches,⁷⁸ possibly founded by the communal action of these independent sokemen.

The following table shows the number of churches in each deanery in Hertfordshire, according to Pope Nicholas's Taxation of 1291, and in like manner the number of priests entered in the Domesday Book (1086):—

	Churches in 1291, ⁷⁹	Priests in 1086.
Deanery of Braughing	31	22
„ „ Hertford	17	11
„ „ Baldock	24	13
„ „ Hitchin	11	6
„ „ Berkhamstead	15	2
Archdeaconry of St. Albans	16	0

This table shows a diminishing proportion in the number of priests entered in the Domesday Book going from the north-east of the county to the south-west. In the deaneries of Braughing, Hertford and Baldock on the eastern side of the county the lands were held principally by laymen, while in the west in the deaneries of Hitchin and Berkhamstead much of the land was held by monasteries, and in the archdeaconry of St. Albans all the land was so held. Although in the western side of the county the land was far less settled than in the eastern part,⁸⁰ and some churches in the west were probably served by the monks of St. Albans—in fact, we know that the three churches at St. Albans probably so served, then existed—yet there

⁷² *V.C.H. Herts.* i, 321.

⁷³ *Ibid.* 311, 325, 336.

⁷⁴ Maitland, *Dom. Bk. and Beyond*, 144.

⁷⁵ *V.C.H. Herts.* i, 322.

⁷⁶ *Ibid.* 340.

⁷⁷ *Ibid.* 339.

⁷⁸ Compare the Domesday of Essex, where under Stifford it appears that 30 acres of land were given to the church by the neighbours in almoign (*V.C.H. Essex*, i, 458).

⁷⁹ *Pope Nich. Tax.* (Rec. Com.), 18, 20, 36.

⁸⁰ See Domesday Map, *V.C.H. Herts.* i.

ECCLESIASTICAL HISTORY

is little doubt that the foundation of manorial churches received more favour among the thegns and other laymen than among the monks of St. Albans, Westminster and Ely who owned the greater part of the western side of the county.⁸¹ A feeling probably existed with the monks that these manorial churches would withdraw the offerings of the people, and hence an endeavour was made to obtain the control of them and their endowments.

As has already been stated, the manorial churches founded by Saxon laymen had substantial endowments of glebe. At Hitchin this amounted to 2 hides, at Ware to 2 carucates, at Welwyn to 1 hide,⁸² at Sawbridgeworth⁸³ to 1 hide, at Stanstead Abbots to 1 carucate, and at Hatfield to half a hide.⁸⁴ The endowments of the Domesday priests apparently became the rectory manors at Hitchin, Welwyn, Cheshunt, Sawbridgeworth, Bishop's Stortford, Standon, Broxbourne, Northchurch, Great Gaddesden, King's Walden, Pirton, Therfield and Wheathampstead.⁸⁵ The churches of all these places except Welwyn, Great Gaddesden and Wheathampstead, together with the churches of some twenty other places, where priests are mentioned in Domesday, were a little later acquired by religious houses to which they became appropriated. Thus the endowments, so liberally given by the Saxon thegns, were largely lost to the parish churches.

Besides the profits from the glebe, the Saxon parish priest received a third of the tithes of the 'shrift district,' which he served under the ordinance of Edgar of 970. The right to dispose of the tithes arising from his lands to any religious foundation remained with the lord of the soil till the third Lateran Council in 1179-80. It is doubtful if those serving the churches on the lands of St. Albans Abbey ever received any tithes till the ordination of vicarages was enforced at the end of the 12th century and later. Tithes were frequently granted away from the church of the parish in which they arose, by lords of the manors and others. Thus Geoffrey de Mandeville granted the tithes of Shenley to Hurley Priory in 1136, but the advowson of the church was given to Walden Abbey.⁸⁶ The tithe of Hemel Hempstead was granted by the Count of Mortain to St. Mary of Grestein in Normandy, and the church to St. Bartholomew's, London.⁸⁷ Hamo de Villiers in the 12th century gave two parts of the tithe of Walkern to St. John's, Colchester, and it was not till later that the church was granted to the same monastery.⁸⁸ At Bushey Geoffrey de Jarpenville apparently built the church about 1166 and endowed it with a virgate of land. He then agreed with the Abbot of St. Albans to allot to it the tithe of half his lands, while Watford took the remaining tithe, an arrangement which remains to this day.⁸⁹ The foregoing evidence with regard to Hertfordshire seems to indicate that the efficient organization and endowment of the parochial clergy, which had been growing up under the Saxon rule independent of the monasteries, was

⁸¹ Of the ecclesiastical arrangements in the 11th century on the vast estate of the Abbot of St. Albans we know little, but in the time of Edward the Confessor there were probably only the three churches already mentioned. Westminster had priests only at Wheathampstead (where it never had the advowson of the church, which was probably founded before the lands were granted to it in 1065) and Ashwell, and estates there and at Titberst in Shenley, Aldenham, Stevenage, Tewin, Datchworth, Watton and Ayot St. Lawrence. Ely had a priest at Hatfield for that great manor and lands at Kelshall and Hadham (*V.C.H. Herts.* i, 311, 312, 313).

⁸² *Ibid.* 343.

⁸³ *Ibid.* 264.

⁸⁴ *Ibid.*

⁸⁵ See under the topographical description of these parishes (*V.C.H. Herts.* ii and iii).

⁸⁶ *V.C.H. Herts.* ii, 273.

⁸⁷ *Ibid.* 227.

⁸⁸ *Ibid.* iii, 157.

⁸⁹ *Ibid.* ii, 185 and 132 n.

A HISTORY OF HERTFORDSHIRE

seriously crippled by the Normans in their desire to increase the power of the monks.

AFTER THE CONQUEST

St. Albans and other religious houses in this county acquired the patronage and tithes of many churches. In these cases the parishes may possibly have received proper ministrations, but when the patron of the church was a foreign abbey such as Grestein, Fougères or St. Ebrulf, all of which houses had churches in Hertfordshire, difficulties were bound to arise. An attempt to meet the situation was made by the appointment of stipendiary priests whose pay appears to have been a matter of individual arrangement. At Walkern a vicar was in charge before the Abbot and convent of Colchester were admitted parsons in 1204, and his status seems to have been permanent.⁹⁰ Many of the stipendiaries, however, held a temporary position, such as that of 'Master Geoffrey,' whom the Abbot and convent of St. Albans placed in charge of the church of Bramfield upon the understanding that he was possessed of no ecclesiastical benefice.⁹¹ Throughout the 13th century there was a struggle between the religious houses and the bishops who were striving to secure for the stipendiary parish priests at once permanence of tenure under episcopal control and a competent livelihood.

The first object of the bishops was to secure the presentation of the incumbents. The rule was apparently insisted upon with some strictness.⁹² Presentation involved institution, which of itself made the vicarage perpetual, in that the incumbent became directly dependent on the bishop and was no longer amovable at the whim of his patron. Hugh of Wells as Bishop of Lincoln was particularly active in the work of securing to these priests adequate support, and the Hertfordshire vicarages of St. Peter's in St. Albans, Pirton, Weston, Great and Little Wymondley, Hitchin, Kimpton, Sandon, Bengo, Little Gaddesden and St. John and All Saints, Hertford, were all ordained in his episcopate (1209-35).⁹³ No registers for the diocese of London are extant for this date, but it is known that the vicarages of Barkway,⁹⁴ Great Hormead,⁹⁵ Ware and Cheshunt⁹⁶ were ordained in the first forty years of the 13th century. In either diocese the general practice was for the tithes to be divided, the lesser tithes being assigned to the vicar, who as the officiating priest received the oblations and obventions of the altar. Both these sources of income were, of course, extremely variable. What obventions and oblations meant in a town parish may be gathered from the case of St. John's, Hertford, where the church belonged to the prior and convent of that place. The vicar derived his income from all offerings made in the name of tithe, mass pennies and altar bread (*in toto pane altaris*), an offering of 3*d.* on Christmas Day, the entire offering at the first mass on Easter Day morning, all offerings made at confessions, annual and triennial dues and half the offerings at marriages. In addition to this the vicar had daily

⁹⁰ Colchester Chartul. fol. 126.

⁹² Ibid. iii, 35, 42.

⁹⁴ See p. 35, above.

⁹¹ *Rot. Hugonis de Welles* (Cant. and York Soc.), i, 29; cf. 21

⁹³ Gibbons, *Liber Antiquus de ordinationibus Hugonis de Welles*, 26-9.

⁹⁵ Newcourt, *Reper.* i, 834.

⁹⁶ *V.C.H. Herts.* iii, 394, 455.

ECCLESIASTICAL HISTORY

a loaf, 3 gallons of beer, the mess of a monk of the house, and an annual stipend of 8*s.* 8*d.*⁹⁷ At Bygrave the vicarage appears to have been originally endowed with oblations and small tithes, and in or about 1223 a return was made showing that the total value of the vicarage was £4 3*s.* 5*d.*, made up of offerings: on All Saints' Day 1*s.*, on Christmas Day 7*s.*, on the Purification 3*s.*, confessions and Palm Sunday 2*s.*, offerings on Easter Day 6*s.* 8*d.*, on St. Margaret's Day 16*s.*; cartage at All Saints was valued at 9*d.*, bread at Christmas at 8*d.*, eggs at Easter at 1*s.*, bread at 8*d.*, the tithes of lambs, wool and flax yielded 20*s.*, those of cheese 8*s.* and small tithes and all other obventions 10*s.* Besides these the vicar received 2 quarters of wheat and 3 quarters of oats from the parson's grange.⁹⁸ The fact of inquiry being held seems to indicate that there was some uncertainty about this arrangement, and shortly afterwards these payments were commuted for a stipend of 5 marks.⁹⁹

The wish to obtain a regular income was not confined to the vicars; the rector or appropriating house was equally desirous of the same thing, and the fluctuating value of the tithes resulted in the arrangement by which a pension or fixed charge was paid by the actual incumbent. In the case of vicarages the pension was recognized by the bishop and set out in the ordination. It varied in amount from the mark chargeable on the vicarage of Layston¹⁰⁰ to 13 marks paid by the vicar of Hitchin to the Abbess and convent of Elstow.¹ The bishops looked on these pensions with jealous eyes, and that they were unfair in some cases seems undoubted. At Ware the church was served by a vicar provided by the priory there, a cell of the Norman abbey of St. Ebrulf. This vicar was 'insufficient,' as a result of being required to pay to the prior not only the tithes of all mills in the parish and of the park and wood of the lord, but also a pension of 10 marks. Ware was a place of importance, and a petition was promoted to Gregory IX. As a result a papal commission of inquiry was issued in 1228-9 to the Bishop of London and the Dean of St. Paul's; the pension was remitted and a competent portion secured to the vicar by the ordination of a vicarage.² This was not the first case of interference by the higher authorities. In or about 1224 Bishop Hugh of Wells had demanded proof of the existence of a pension of 3 marks, said to be due from the vicar of All Saints, Hertford, to the prior and convent of that place.³ The system was frequently adopted by religious houses where no vicarage was ordained, and at the same time as the Hertford inquiry was taking place the bishop forbade the newly instituted rector of St. Peter's, Berkhamstead, to pay any pension to the patrons, the Abbot and convent of Grestein, until they should have proved it due and customary.⁴ The arrangement was not unusually made in cases where an alien house had received the grant of a church. The Prior and convent of the Breton house of Fougères made an agreement at the beginning of the 13th century with the Dean and Chapter of St. Paul's, whereby the latter were to receive a pension of 8 marks⁵; in a similar way Warner, Prior of the

⁹⁷ Gibbons, *Liber Antiquus*, 29. ⁹⁸ *Rot. Hugonis de Welles* (Cant. and York Soc.), iii, 40. ⁹⁹ *Ibid.* 42.

¹⁰⁰ Newcourt, *Repert.* i, 843.

¹ *Rot. Hugonis de Welles* (Cant. and York Soc.), i, 191.

² Newcourt, *Repert.* i, 900.

³ *Ibid.* iii, 46.

⁴ *Ibid.* cf. 41. For pensions paid in the diocese of Lincoln see Salter, *A Subs. collected in the Diocese of Linc.* 173-9.

⁵ *Hist. MSS. Com. Rep.* ix, App. i, 33.

A HISTORY OF HERTFORDSHIRE

Hospital of St. John of Jerusalem in England in 1190 granted the church of Broxbourne to the Bishops of London in return for a yearly payment of 4 marks.⁶ The system presented so many advantages that it was inevitable that it should be adopted by the rector whose cure was served by a resident and perpetual vicar.⁷

Whatever may have been the financial position of the average curate or stipendiary priest, there is evidence that the parson or vicar was frequently a man of means.⁸ Thus in 1350 the vicar of Codicote had £20 stolen from a chest in his chamber.⁹ Three years later the vicar of Weston seems to have had in his pocket 30s. which was stolen from him when he went out to supper with one of his parishioners.¹⁰ The rector of Lilley, who contracted a debt of £40 in about 1464, must have been able to give adequate security for so large a sum.¹¹

Strong as was the tendency for the priest to live the ordinary life of his fellows, there was, at least in theory, one point on which he was differentiated from the layman and that was by his celibacy. There can, however, be no doubt that the rule was only enforced by the bishops with the greatest difficulty and incomplete success. Throughout the 13th century the bishops were strenuous in their efforts, which were seconded by the papal see.¹² Alan, the vicar of Ashwell, was married, but Bishop Hugh or Wells only gave him the parsonage on his entering into a bond in 30 marks to have no dealings with the woman Annora.¹³ In 1237 the declaration of Otto provided that all married clerks should be deprived of their preferment,¹⁴ but it seems probable that this extreme step was only taken in cases of public scandal, the strictness with which the rule was observed depending greatly on the vigilance of the diocesan and his officials. Grossteste made a rigorous inquisition on this matter throughout his diocese in 1251, and deprived transgressors,¹⁵ but unfortunately the returns have not been preserved. During the 14th century concubinage was apparently not uncommon. Nor was it apparently regarded as reprehensible. John, chaplain of Ayot St. Lawrence, found no objection to complaining of having been robbed of a linen shirt, a belt and purse when visiting his mistress one June night in 1367.¹⁶ In very bad cases deprivation was carried out; thus in 1313 Bishop Ralph Baldock deprived Nicholas de Hadham, vicar of Ardeley, but here the guilt was deepened by three of the four women involved being his penitents.¹⁷ Thomas, the rector of Kelshall, when cited for dilapidations of the goods of his church and for incontinence was merely suspended by Bishop Sutton for three years.¹⁸

The 14th century was an age of violence; the number of murderous assaults was doubtless increased by the habit of carrying weapons, which, in spite of episcopal injunctions, was common to clergy and laymen alike. The basildard formed a part of the cleric's ordinary dress and was worn by Robert de Maddingley on Trinity Sunday, 1358. For some reason he had fault to find

⁶ *Hist. MSS. Com. Rep.* ix, App. i, 32.

⁷ *Rot. Hugonis de Welles* (Cant. and York Soc.), i, 94.

⁸ cf. *Add. Chart.* 24065; *Hist. MSS. Com. Rep.* ix, App. i, 30-1, 39; *Cal. Pat.* 1391-6, p. 543.

⁹ *Anct. Indictments*, K.B. 9, file 38, m. 13 d.

¹⁰ *Ibid.* m. 27.

¹¹ *Cal. Pat.* 1461-7, p. 318.

¹² *Cal. Papal Letters*, i, 90.

¹³ *Rot. Hugonis de Welles* (Cant. and York Soc.), i, 79.

¹⁴ *Lea, Hist. of Clerical Celibacy*, i, 350.

¹⁵ *Matt. Paris, Chron. Maj.* (Rolls Ser.), v, 256.

¹⁶ *Anct. Indictments*, K.B. 9, file 37, m. 13.

¹⁷ *Reg. Radulphi Baldock* (Cant. and York Soc.), ii, 160.

¹⁸ *Linc. Epis. Reg. Sutton*, Memo. fol. 121.

ECCLESIASTICAL HISTORY

with Ralph, the clerk ; out in the street the vicar upbraided him and drawing his basilard would have struck him. Ralph took to his heels, the vicar following basilard in hand. In his excitement Ralph rushed down a lane which proved blind. He drew his knife, struck at Robert and killed him.¹⁹ This carrying of weapons doubtless accounts for many of the cases of assault which appear so inexplicable to the modern mind. John, vicar of Stanstead Abbots, attacked one of his parishioners and wounded him grievously.²⁰ Nicholas Turvey, parson of Loughton, similarly attacked one William Austyn at Berkhamstead in 1371,²¹ while in the following year the parson of Caldecote was outlawed for his assault on Richard Clerk.²² Again and again the clergy are found side by side with their parishioners in the affrays that enlivened the country life of the 14th century. Though most frequently these collisions were the result of poaching expeditions, yet sometimes they seem to have been political in character. It was doubtless resentment at the action of the Crown against the Templars²³ that induced the parson of Clothall to join a nocturnal expedition of over seventy persons to Baldock in the autumn of 1312. On a different plane was a crime perpetrated at Sarratt one Sunday in 1462, when James Roche, the vicar, with Roger Witton, an esquire, and others set on Richard Gloucester, a man at arms of the place, murdered him and buried the body in a field.²⁴ The affair was discovered and Roche took to flight.²⁵

Such a story inevitably leads to a questioning as to the punishment of the mediaeval criminous clerk. The clerk in trouble with the civil authorities generally found himself imprisoned in Hertford Castle, and thence he would appeal to his bishop to be claimed as an ecclesiastical person and exempt from the jurisdiction of the lay courts. Thus in 1287 William de Aston, Walter the chaplain of Leighton and Robert the barber of Wycombe were accused of burglary in the church of St. Peter, Berkhamstead, but Walter and Robert were claimed as clerks by the vicegerent of the Bishop of Lincoln and freed as innocent.²⁶ The secular authorities seem to have viewed the process with dislike at a very early period, and in 1248 the sheriff of the county was fined for releasing the chaplain of Hertingfordbury to the Bishop of Lincoln without warrant.²⁷ The usual proceeding was then for the bishop to issue a commission of inquiry such as that held in 1306 on the conduct of John son of Henry de la Fen of Clavering, clerk, who was imprisoned for trespasses against Ralph the Tanner of Hatfield.²⁸ In the ecclesiastical courts the ancient test of purgation still survived and was probably employed in the case of John.²⁹

The prison of the Bishops of London was at Stortford, and thither came criminous clerks from all parts of the diocese.³⁰ In September 1344 there were fifty prisoners in this gaol and seven were received during the following

¹⁹ Chan. Misc. bdl. 62, file 2, no. 69. Ralph was to receive the king's pardon as the jury declared he killed Robert in self-defence. ²⁰ Anct. Indictments, K.B. 9, file 38, m. 10.

²¹ Chan. Misc. bdl. 62, file 4, no. 153. ²² Ibid. no. 175. ²³ *Cal. Pat.* 1307-13, p. 539.

²⁴ 'Reg. Whethamstede,' *Reg. Abbatum Mon. S. Albani* (Rolls Ser.), ii, 11. No coroners' rolls for Hertfordshire at this date are preserved in the P.R.O. ²⁵ Ibid.

²⁶ Assize R. 325, m. 36. For the hanging of a parson of Buckland see *ibid.* 323, m. 44.

²⁷ *Ibid.* 318, m. 25 d. Richard was accused of confederacy in the murder at Hertingfordbury of Basilia de Rocheford and Ralph her son.

²⁸ *Reg. Radulphi Baldock* (Cant. and York Soc.), i, 38.

²⁹ *cf. ibid.* 1.

³⁰ *cf. Exch. K.R. Eccl. Doc. bdl. 8, no. 1.*

A HISTORY OF HERTFORDSHIRE

year, while no less than twenty-nine died during this period.³¹ At Michaelmas 1347 there were twenty-five prisoners, twelve were received in the course of the year and nine died.³² It appears possible that here there was some such free prison as that attached to certain of the civil gaols.³³ It seems, moreover, that extra liberty was occasionally allowed to clerics imprisoned in Hertford Castle, for in 1363-4 Walter, a criminous priest, was given into the charge of the rector of St. Nicholas, Hertford; he escaped, much to the annoyance of the gaoler, who promptly clapped the rector into gaol.³⁴ Besides these misdemeanours occasional instances are found among the parochial clergy of what was known as apostasy—the deliberate desertion of the life of a cleric for that of a layman. In the 13th century the military orders opened a life of adventure to the churchman, and it was perhaps as a Templar that the parson of Bygrave in 1219 assumed the knightly sword.³⁵ In the 15th century there was no such way of escape, and several instances of apostasy may be found. Roger Caldecott, vicar of Norton, deserted his cure about 1478 and was deprived³⁶; at Sarratt in 1485 Thomas Hemyngford, who had held the living since 1476, was similarly dealt with.³⁷ Deprivation does not, however, seem to have been frequent, and the lists of prisoners at Stortford³⁸ suggest that the majority of criminous clerks imprisoned there were not in full orders. Some of them were probably drawn from the class of chaplains and chantry priests which was becoming important at this date. The impulse towards founding monastic establishments had almost failed by the beginning of the 14th century, even as the sacrificial aspect of the mass had grown in popularity. The chantry was of course no new thing; as far back as 1247 the rector of Eastwick had obtained papal confirmation of an ordinance directing that in Eastwick Church there should be three priests—the rector, a priest to say daily the office of the Blessed Virgin, and a priest to say daily that of the dead.³⁹ Chantries were founded in almost every church in Hertfordshire and were frequently associated with the cult of our Lady.⁴⁰

According to modern ideas one of the greatest scandals of the Church of the 12th and 13th centuries was the holding of benefices by persons totally incapable of fulfilling the duty of their office and incapable from voluntary causes. The deacon, the sub-deacon, the acolyte, would seek and obtain benefices with no intention of taking full orders, for the mediaeval mind had an inveterate tendency to consider the rector, as it has well been put, rather as 'the tenant of the church property than the pastor of the people.'⁴¹ In practice this idea was adopted by the papacy, the Crown, and occasionally by the episcopate. In theory the church required every beneficed person to be in priest's orders, and a constitution to this effect was issued by the Council of Lyons in 1292.⁴²

³¹ Mins. Accts. (Gen. Ser.), bdle. 1140, no. 1.

³² Ibid. no. 3.

³³ For the escape of clerks from the gaol of St. Albans see Anct. Indictments, K.B. 9, file 38, m. 13.

³⁴ Ibid. file 37, m. 15. For outlawries of clerks see Chan. Misc. bdle. 62, *passim*.

³⁵ *Rot. Hugonis de Welles* (Cant. and York Soc.), iii, 35.

³⁶ *Reg. Abbatum Mon. S. Albani* (Rolls Ser.), ii, 188.

³⁷ Ibid. p. xlv.

³⁸ Mins. Accts. (Gen. Ser.), bdle. 1140, no. 1-3. One 'priest' was received there in each of the years 1344-5 and 1347-8.

³⁹ *Cal. Papal Letters*, i, 235.

⁴⁰ See Topographical section, *passim*.

⁴¹ Stocks and Bragg, *Market Harborough Rec.* 21.

⁴² Fleury, *Inst. du droit canonique*, cap. iii, viii; Linc. Epis. Reg. Sutton, Memo. fol. 55.

ECCLESIASTICAL HISTORY

The bishops doubtless did their best, and it is of interest to note that of the four Hertfordshire incumbents collated by Bishop Hugh of Wells⁴³ two were described as 'clerks,' while the others were graduates and presumably in full orders. The view of Edward I may be judged from rather later examples: John de Sandale, sub-deacon, held the living of North Mimms in 1309,⁴⁴ he was afterwards Lord Chancellor; Robert de St. Albans, deacon and king's clerk, was presented by Edward I to the living of Essendon, but made no attempt to take further orders.⁴⁵ It was only to be expected that the less important patrons should follow the royal example.⁴⁶ In 1297 Archbishop Peckham issued constitutions by which a rector in minor orders was forbidden to retain his benefice,⁴⁷ but a dispensing power had been reserved to the bishops⁴⁸ by the Council of Lyons, and what could only be obtained with difficulty in England was much more easily acquired at the Papal Court. In 1309 William de Langley was a notable pluralist with livings in East Anglia, Yorkshire and at Eastwick. He was 'molested' by the Archbishop of York for neglecting to take holy orders, applied to the pope and received dispensation to retain his benefices.⁴⁹

One cause for dispensation from taking orders admitted by the bishops in the 13th century was the desire to study theology. The Council of Rouen in 1231 gave the beneficed clerk the alternative of ordination or study. The necessity for this provision and the vigilance required of a bishop may be judged from the difficulty of Bishop Hugh of Wells in obtaining an efficient parish priest for Shenley. The patroness, Joan le Blunt, had sent her son Richard into the church. Richard in 1221 was described as a clerk, but his learning made no favourable impression on Bishop Hugh, who thought, however, that 'there was hope of him.' So the young man was instituted, but ordered to the university under pain of deprivation, while the cure was placed in the hands of Hugh de Rof, chaplain.⁵⁰ Richard evidently failed to reach the required standard, and the bishop perhaps carried out his threat, for in the following year Joan was again presenting to the living. This time her nominee was Matthew son of Waleran, clerk, but the bishop seems to have made inquiries and to have been suspicious of his acquirements, for, though Matthew was instituted, the bishop insisted on an oath being taken in his presence that he would attend the university for study. A note was added, somewhat grimly, to the record of these doings that 'if, as is said, he do not attend the schools, his benefice shall be sequestered into the hands of the bishop.'⁵¹ Bishop Hugh was evidently well informed, for another rector was instituted a year later.⁵² That the bishop's requirements were not excessively high may be judged from the constitutions of Grossteste. According to these⁵³ 'each shepherd of souls and every parish priest' was required to know the commandments, the nature of the seven deadly sins and of the seven sacraments. Those who were priests

⁴³ *Rot. Hugonis de Welles*, i, 126, 127.

⁴⁴ Newcourt, *Repert.* i, 40.

⁴⁵ *Linc. Epis. Reg. Sutton*, Memo. fol. 56.

⁴⁶ cf. *Rot. Hugonis de Welles* (Cant. and York Soc.), iii, 45, 47.

⁴⁷ Lyndewode, *Provinciale* (ed. 1679), 22, 24.

⁴⁸ For Hertfordshire examples see *Linc. Epis. Reg. Sutton*, Memo. fol. 55, 56.

⁴⁹ *Cal. Papal Letters*, ii, 51.

⁵⁰ *Rot. Hugonis de Welles* (Cant. and York Soc.), iii, 37.

⁵¹ *Ibid.* 39.

⁵² *Ibid.* 41.

⁵³ *Epistolae* (Rolls Ser.), 155.

A HISTORY OF HERTFORDSHIRE

were required to know especially the requisites of true confession and baptism with a simple understanding of the faith.

In the 14th century it was usual to reverse the modern practice, and the student acquired his benefice before attending the university, and frequently with the express object of maintaining himself there.⁵⁴ If the complaints of the University of Oxford are to be believed, it was a wise precaution to secure a benefice and with it a regular income before proceeding to the university. Once there, a living was only obtained with difficulty, even men with established reputations seeking ecclesiastical preferment in vain.⁵⁵ The estimate of academical attainments held by the officials of the London diocese may, perhaps, be gathered from the entire absence of any entries against the names of Hertfordshire incumbents instituted before 1390.⁵⁶ From this time, however, the possession of degrees is carefully noted, and the modern reader is struck by the comparative scantiness of graduates among the parochial clergy. At Albury, Amwell, Anstey, Little Hormead, Meesden, Thorley and Widford no graduate held the living in the 14th or 15th century. Yet Albury belonged to the Treasurer of St. Paul's Cathedral, Amwell to the Prior and convent of Hertford, Anstey to the Dukes of York, Hormead and Meesden to St. Mary de Graces, London, Thorley to the Bishops of London, and Widford to the Prior and convent of Bermondsey. Perhaps Oxford had cause to complain. The greatest patrons of learning, according to this test, were the Abbess and convent of the Cambridgeshire house of Chatteris, who presented two Masters of Arts, two Doctors of Law, and one Bachelor of Divinity between 1394 and 1495 to their living of Barley out of a total of ten incumbents for the period.⁵⁷ The Carthusians of Sheen presented graduates continuously to the vicarage of Ware from 1451 to 1480, but this town must have been especially attractive to a man of parts from its facilities for communication. The scholar was receiving extended patronage in the second half of the 15th century, but it must be remembered that he was a pluralist whenever possible.

Against the prevalent abuse of pluralities the Church had made an official pronouncement at the Fourth Lateran Council of 1215. This Peckham strove with all his might to enforce, and the constitutions of Ottobon also dealt with the subject.⁵⁸ As usual a dispensing power was reserved to the papacy. As early as 1219 a note appears against the record of the institution of a rector of Aldenham to the effect that the presentee had licence from the papal legate to hold a second living in plurality.⁵⁹ The modern excuse of poverty was not adduced, and no difficulty in obtaining dispensation seems to have been experienced by John de Fleburth, who desired to acquire the living of Stubton in Lincolnshire, valued at 25 marks, in addition to his rectory of Hadham, which was worth £40 the year.⁶⁰ Some forty years later the living was valued at 100 marks, but this was no obstacle to the

⁵⁴ For licences of absence to rectors about to study at the universities see Linc. Epis. Reg. Sutton, Memo. fol. 206-7. The practice was continued until the late 16th century, when it was attacked by the Puritans and fell into disfavour. In 1559 Cranmer granted a dispensation to Thomas Butler, aet. 14, a scholar, to hold the living of Watton at Stone. This was confirmed by Elizabeth (Harl. MS. 7048, fol. 252).

⁵⁵ Anstey, *Epistolae Academicæ Oxon.* 168.

⁵⁶ See Newcourt, *Repert.* i, *passim*.

⁵⁷ *Ibid.* 799.

⁵⁸ See Capes, *The Engl. Church in the Fourteenth and Fifteenth Centuries*, 22.

⁵⁹ *Rot. Hugonis de Welles* (Cant. and York Soc.), i, 137; see also *Cal. Papal Letters*, i, 245.

⁶⁰ *Cal. Papal Letters*, ii, 35.

ECCLESIASTICAL HISTORY

rector from obtaining other preferment.⁶¹ The granting of dispensations was a distinct source of income and was jealously guarded by the papacy. Hugh de Nottingham held the rectory of Hatfield in plurality in about 1318, and was proceeded against and forced to resign; the living, valued at £37, was then granted in plurality to William de Steeping, warden of the hospital of St. Andrew, Denhall, co. Chester, in the diocese of Lichfield.⁶² It must be conceded that except in the case of a few men such as Grossteste or Peckham mediaeval public opinion was not shocked by pluralism. The king and the great lord were apt to pay their secretaries in livings rather than ready money. Thus in 1343 John Earl of Warenne sought a canonry of Exeter for John, son of William Pippard, rector of Aspenden,⁶³ and in 1363 Mary Countess of Pembroke begged for her clerk John de Audelliers a canonry of Chalons in addition to his church of Anstey and a canonry of Lincoln for her clerk Philip de Melrith, rector of Westmill.⁶⁴ More acquisitive than these men was John de Saucey, B.C.L., who persuaded his patron in 1351 to apply for a licence to enable him to hold the churches of St. Magnus, London, and Cheshunt as well as a prebend of Glaseneye and a promised prebend of Wells.⁶⁵

The non-resident or pluralist rector was, of course, faced with one very real difficulty. His revenues, paid partly in kind, were generally agricultural in origin, and it would seem to have been no easy matter to find a reliable steward.⁶⁶ It was natural, therefore, that the system of composition, that universal solvent of mediaeval difficulties, should be adopted. The arrangement took the form of a lease of the rectory for a fixed annual rent or farm to the incumbent. Abuses were bound to follow, and in 1321 Bishop Burghersh issued a mandate to all archdeacons in the diocese of Lincoln forbidding the letting of any rectories to farm without episcopal licence.⁶⁷ The matter was also regulated by various constitutions, though these were always liable to be superseded by papal action. Thus in 1437 the powerful pluralist Robert Fitz Hugh, vicar of St. Michael's, Wood Street, rector of Kelshall, canon of St. Martin-le-Grand, and prebend of 'Buoghesh,' obtained licence to let to farm for any term and to any person, laymen not excepted, the fruits of any or all benefices in his hands.⁶⁸ The difficulty raised by the prohibition of lease to a secular person was occasionally overcome by associating the stipendiary priest with the farmer in the grant. At Clothall the rector in January 1485-6 was Richard Woodward, clerk in the King's Chancery; he leased the tithes, lands of the rectory and the glebe-house to William Frank, chaplain, and Simon Wright, of Baldock, yeoman, for three years.⁶⁹ A somewhat similar lease made in March 1543-4 by the rector of Hinxworth led to some disorder, for the rector complained that when at the end of the term he refused to renew the lease, the farmers cut down 'forty great Elmes and Asshes' in the churchyard and carried them away.⁷⁰ It was to be expected that the farmer, while responsible for the charges incidental to the possession of the rectorial tithes,⁷¹ should avoid expense as far as possible. The result

⁶¹ *Cal. Papal Pet.* 149.

⁶² *Cal. Papal Letters*, ii, 172.

⁶³ *Cal. Papal Pet.* 19.

⁶⁴ *Ibid.* 410.

⁶⁵ *Ibid.* 219.

⁶⁶ See the numerous cases of pardons recorded in the Patent Rolls for failure to render accounts.

⁶⁷ *Linc. Epis. Reg. Burghersh*, Memo. fol. 27.

⁶⁸ *Cal. Papal Letters*, viii, 636.

⁶⁹ *Anct. D. (P.R.O.)*, C 2887.

⁷⁰ *Star Chamb. Proc. Edw. VI*, bde. 5, no. 81.

⁷¹ i.e. the repair of the chancel, &c.

A HISTORY OF HERTFORDSHIRE

was that in 1518 when the rectories of Hertford, Bengeo, 'Herefield,' Pirton, Ashwell and Aspenden were all let to laymen, the chancels of 'Herefield,' Pirton and Ashwell were in a state of serious disrepair.⁷² It is known that in 1543 farmers were in possession of the churches—i.e. rectorial tithes—of Bygrave, Little Munden, Throcking, Ardeley, Wheathampstead, Lilley, King's Walden and Harpenden,⁷³ and the frequency of the practice shows that the lease of a rectory was profitable to the lessee. That it was equally advantageous to the absent rector may be gathered from the instance of King's Walden, where the farm of the 'rectory' brought in £16 13s. 4d. to the priory of Old Malton, Yorkshire,⁷⁴ which paid the 'curate' £5 6s. 8d. as stipend.⁷⁵ This was a very usual sum for a 'curate' to receive at this date; but the stipends were not always liberal, and the farmer of the church of Watton at Stone himself granted an annuity to the curate to enable him the better to sustain the burdens.⁷⁶ At a later date the salary seems to have been usually paid by the farmer.⁷⁷ A curious example of the results of such an arrangement was seen at St. Albans soon after the Dissolution. The abbey had granted to Thomas Chadsley the chapel of St. Andrew at farm at a rack rent; as long as the abbey was occupied he drew his profit from the tithes and offerings of the servants and household, but these disappeared with the Dissolution, and the cure was unserved as Chadsley could no longer afford to pay a curate his stipend.⁷⁸ The practice of farming rectories survived the Reformation, the rectory of Hatfield, 'esteemed one of the best in England,' being a notable example of the abuse.⁷⁹

Closely connected with the abuse of pluralities was that of non-residence. And what non-residence meant may be judged from the ironical remarks of Bishop Porteus made to the clergy of the diocese of London in his charge of 1791,⁸⁰ 'much too large a proportion' of whom were non-resident. 'The instrument of dispensation,' he says, 'requires 13 sermons a year and hospitality for two months.' The church of the early 19th century was in this respect in much the same case as six hundred years before, and nothing more scandalous can be imagined than the case of Mr. George Pretyman, who then held the rectory of Wheathampstead,⁸¹ with the living of Chalfont St. Giles, &c., and derived from his livings a net income of £1,697, exclusive of cathedral endowments. The bishops of the 13th century recognized the evil. In several cases, as at Throcking, Bishop Hugh of Wells instituted a rector on condition that he was resident and served the cure in person.⁸² Grossteste felt strongly on the subject, but the practice grew and was, of course, inevitable in the case of rectors who had failed to take full orders or were engaged in theological study.⁸³

In the 14th century the bishops would take action in flagrant cases. John de Penrith deserted his cure of Baldock and in 1359 Bishop Gynwell gave a commission to William rector of Holywell (Holwell) to minister in

⁷² Visit. of the Archdeaconry of Huntingdon (Linc. Epis. Reg.).

⁷³ Ibid. *sub anno*.

⁷⁴ Mins. Accts. Hen. VIII, no. 4618, m. 9.

⁷⁵ Salter, *A Subsidy* . . . 1526, p. 176.

⁷⁶ Linc. Epis. Reg. Buckingham, Memo. fol. 104 d.

⁷⁷ Visit. as above, 1543.

⁷⁸ Ct. of Aug. Proc. bdle. 31, no. 68.

⁷⁹ Salmon, *Hist. of Herts.* 213.

⁸⁰ Porteus, *Charge to the Clergy of the Diocese of London* (1791), 8-10.

⁸¹ Cussans, *Hist. and Antiq. of Herts. Dacorum Hund.* 346 n.

⁸² Rot. Hugonis de Welches (Cant. and York Soc.), i, 59.

⁸³ See above.

ECCLESIASTICAL HISTORY

the parish church.⁸⁴ The negligences of Gilbert de Mursel, rector of Benington, were corrected.⁸⁵ In 1420 Richard Field, the vicar of North Mimms, was deprived; it was proved in July of that year that he had administered the sacraments in the church from Pentecost to the following Lent but had not been seen since.⁸⁶ From the wording of the depositions in this case it seems that the real cause of his deprivation was not, however, non-residence, but the fact that he had made absolutely no provision for serving the cure, which had been neglected ever since his departure.⁸⁷ The prevalence of the custom, indeed, apart from the remarks of Porteus, shows that the bishops were generally ready to grant dispensations for non-residence provided that a competent curate was supplied. Until the end of the 16th century, indeed, if not later, the curate was essentially one placed in charge of a parish by or for the absent incumbent,⁸⁸ though the term might also be used for a coadjutor during the illness of the incumbent, and very occasionally for a chantry priest; the application of the word to the assistant of a resident parish priest is a later use not found generally before the close of the following century. The number of 'curates' employed should therefore give the actual, though not the legal, number of non-resident incumbents. For the early years of the 16th century the evidence on this point is very full for the diocese of Lincoln, though deficient for that of London. The visitation of the archdeaconry of Huntingdon in 1518-19 shows that there were non-resident incumbents at Welwyn, All Saints Hertford, Letchworth, Kelshall, Aspenden, Therfield, Ashwell, Radwell, Westmill and Wallington.⁸⁹ In only one case is any indication of the cause for non-residence given, but the rector of Kelshall was away on the queen's service. A similar visitation made in 1530 gives a similar result, non-residence being the rule at Welwyn, Gaddesden, Aldenham, Ayot St. Lawrence, Great Munden, Kelshall, Therfield and Wallington.⁹⁰ By a fortunate coincidence a clergy list of but four years earlier has been preserved, and a comparison of these two documents brings to light the actual non-residence of the sixty-six Hertfordshire benefices of the diocese of Lincoln assessed in 1526⁹¹; no less than thirty-five were served by curates who are found in charge of all the livings said to be held by non-residents in 1530 except Kelshall, Therfield and Wallington, where the duty was apparently discharged by stipendiary priests. The practical result of non-residence was seen in the report in 1518 that at Radwell the chancel was in ruins. At Welwyn both rectory and chancel were badly in need of repair, while at Letchworth the curate was 'insufficient.' The state of affairs at Ashwell was particularly scandalous; the curate would seem to have followed his vicar's example of non-residence, for he was beneficed elsewhere and the vicarage-house was let to farm. In 1530 the report was rather better, but the chancel at Aldenham and the churchyard wall at Therfield were both in a ruinous state. These numbers may be compared with those furnished by a similar list made in 1543,⁹² when the Reformation was in its earlier stage. At only twelve places is

⁸⁴ Linc. Epis. Reg. Gynwell, Memo. fol. 134.

⁸⁵ Ibid. Burghersh, Memo. fol. 111.

⁸⁶ Ibid. Fleming, Memo. fol. 241 d.

⁸⁹ Atwater's Visit. (Linc. Epis. Reg.).

⁹⁰ Visit. of Archdeaconry of Huntingdon, 1530 (Linc. Epis. Reg.).

⁹² Visit. of Archdeaconry of Huntingdon, 1543 (Linc. Epis. Reg.).

⁸⁷ Ibid.

⁸⁸ Salter, op. cit. Intro.

⁹¹ Salter, op. cit.

A HISTORY OF HERTFORDSHIRE

any reason for non-residence assigned. Richard Coches, rector of Kelshall, was chaplain to Henry VIII, Master Edward Langton, rector of Flamstead, was clerk of the King's oratory, while the rector of Little Munden and the vicar of Great Gaddesden were chaplains to Lord Douglas and the Countess of Derby respectively. As usual pluralities accounted for a large proportion of the non-residence: Dr. Pomell, vicar of Ashwell, was rector of St. Katharine Coleman and lived in London. 'Mr. Cordall' was rector of the valuable living of Welwyn, but lived far away at Brancepeth in co. Durham; Dr. Cooke of Bygrave was at St. Stephen's, the rector of Graveley at Ayot St. Lawrence, the vicar of Hitchin at 'Northam in Suffolk' and the rector of Wheathampstead at Salisbury. But while these incumbents were recognized as non-resident, it is evident that a still further number only visited their Hertfordshire benefices on occasion, for in the sixty-three parishes visited forty-one curates were employed.

At a time when the central authorities were enforcing their views on clergy and laity alike, when the whole of the royal policy was bent towards unity of control, it was impossible that the authoritative pronouncement on affairs should be left in each parish to the curate. Non-residence was objectionable not on the grounds of ethical principle but of public policy. In 1542 Bonner insisted on the royal dispensation being obtained for plurality and non-residence,⁹³ but no further steps seem to have been taken. Elizabeth followed a surer plan and, under the pretext of a clerical subsidy, mulcted the holders of benefices in 6*s.* 8*d.* for every year in which a curate was employed.⁹⁴ The returns made in 1575 show how greatly the practice had decreased, and this evidence is supported by the clergy lists. Thus in 1586 in the archdeaconry of St. Albans and deanery of Braughing only eight curates were employed,⁹⁵ while at about the same date only ten appear for the whole of the Hertfordshire parishes in the archdeaconry of Huntingdon.⁹⁶

The most casual observer of the village churches of Hertfordshire can hardly fail to be struck by the very large amount of 14th and 15th-century work they still display. It seems as though the whole people had been seized with impatience at the old things, and as far as was in their power had swept them aside in their endeavour after what seemed the newer and more desirable way. In addition to this longing for reform there seems reason to believe that some of the churches had fallen into disrepair during the late 13th and early 14th centuries when the drain of men and money to the Scottish and French wars must have diverted much ready money abroad. The bishops seem to have done all in their power to maintain the churches in reasonably good condition, and mention has already been made of the sentence of three years' suspension passed by Bishop Sutton (1280-99) on Thomas, rector of Kelshall, for incontinence and dilapidation of the goods of the church.⁹⁷ The responsibility of keeping the chancel in good repair fell, of course, on the rector, but the duty of maintaining the nave rested with the parishioners. That there was sometimes difficulty in enforcing this obligation is evident from various entries in the episcopal registers. The church of Hitchin had been

⁹³ Lond. Epis. Reg. Bonner, fol. 38.

⁹⁵ Visit. 1586 (Lond. Epis. Reg.).

⁹⁷ Linc. Epis. Reg. Sutton, Memo. fol. 121.

⁹⁴ Exch. Spec. Com. 13 Eliz. no. 3268.

⁹⁶ Lambeth MS. xii, no. 2.

ECCLESIASTICAL HISTORY

rebuilt shortly before 1301, when the tower was in ruins and was said to be in a dangerous condition.⁹⁸ The energy of the parishioners was exhausted and they refused to do more. The archdeacon failed to bring them to a better state of mind, and finally he reported the matter to the Bishop of Lincoln, who issued a commission to the Archdeacon of Bedford to compel the people to begin repairs.⁹⁹ The work, however, proceeded but slowly, and apparently unwillingly, for in 1314 public opinion seems to have made no outcry against certain persons who kept in their own hands goods left towards repairing the fabric, and the bishop proceeded against them by sentence of excommunication.¹⁰⁰ At Stapleford, also, an episcopal injunction was needed and issued in 1301 before the parishioners would finish their belfry.¹ That this state of affairs was not confined to the early years of the 14th century is evident from the fact that in 1382 Bishop Buckingham warned the people of St. Mary's, Berkhamstead, that he would proceed to excommunication unless they would contribute to the repairs of their church.²

The money for these repairs and rebuildings was probably collected by the churchwardens, who with the parson were the parties to the contract with the master mason.³ In many cases special parts of the work were undertaken by individuals whose memory was preserved by inscription or achievement. In 1728 the steeple and east window of Knebworth Church still bore the arms of Sir John Hotoft, lord of the manor in 1428,⁴ while at East Barnet a small stone in the middle aisle besought prayer for the soul of John Beauchamp, the builder.⁵ Gifts such as these could only, however, have been made by the man of comparative wealth; but the custom of leaving at least a small sum to the fabric of the parish church appears to have been well nigh universal, and innumerable cases might be cited.⁶

All these were local means of raising money, but there was a natural desire, then as now, to appeal to a larger public. The system of indulgences for this purpose was in favour throughout the 14th century. One of the earliest Hertfordshire indulgences was that obtained from the pope in 1291 for penitents who visited Norton Church on the four feasts of the Blessed Virgin Mary and their octaves.⁷ Such a pilgrimage was rewarded by the relaxation of a year and forty days of enjoined penance and was bound to bring many to make offerings in the church. Under Bishop Dalderby (1300-20) indulgences became numerous; they were obtained in aid of the funds of the churches of Puttenham and Tewin, the conventual church of Ashridge and the priory of Hertford.⁸ Two like indulgences were issued by Bishop Bek (1342-7) for the churchyards of St. John the Evangelist of Aldenham and St. Nicholas of Great Munden.⁹

In two of the four returns made for gilds in Hertfordshire in 1346¹⁰ there is express mention of the chaplain of the fraternity, and in the third his existence is implied. A comparison of the names of places at which

⁹⁸ Linc. Epis. Reg. Dalderby, Memo. fol. 44 d.

⁹⁹ Ibid. ¹⁰⁰ Ibid. fol. 166.

¹ Ibid. fol. 24 d.

² Ibid. Buckingham, Memo. ii, fol. 248.

³ cf. De Banco R. 921, m. 271.

⁴ Salmon, *Hist. of Herts.* 261; *V.C.H. Herts.* iii, 115.

⁵ Salmon, op. cit. 56; cf. pp. 11, 95; *V.C.H. Herts.* ii, 174.

⁶ e.g. *Hist. MSS. Com. Rep.* ix, App. 46. Sharpe, *Cal. of Wills proved in the Court of Hustings*, ii, 296; P.C.C. 4 Luffenam, 31 Stoneham, 11 Stokton, 22 Godyn, 1 Wattys, 1 Milles. ⁷ *Cal. Papal Letters*, i, 531.

⁸ Linc. Epis. Reg. Dalderby, Memo. fol. 12, 44, 51, 317, 399.

⁹ Ibid. Bek, Memo. fol. 6 d.

¹⁰ Chan. Misc. file 39, no. 64-7.

A HISTORY OF HERTFORDSHIRE

gilds are known to have existed with the returns of the 16th century makes it probable that many of the stipendiary priests were really in the employ of the gilds. Reference has already been made to the status of these supernumerary priests, and it may well be imagined that their independence of the incumbent and peculiar relationship to a select body of parishioners might lead to difficulties. At Berkhamstead in the early 16th century dissensions arose between the parson and George Prior, 'brotherhood priest.' The parson complained to the Bishop of Lincoln that Prior was 'a comyn baratur and breker of the kynges peas . . . a comyn goar and seker of susspessyus and baudy howsys . . . a pleyer at cardes and alle un lawfull gamys.' Prior was summoned before the bishop, and with thirty-one of his 'neyburns gentyllmen and other substantial men' rode to Woburn to refute the charge. The bishop bound him over, but this did not satisfy the parson, and Prior finally appealed to the Crown for redress,¹¹ though what he hoped to gain thereby is not very clear.

The earliest known gild in Hertfordshire was simple in character. In or about 1333 twelve men of Hertford agreed to maintain twelve candles to burn before the image of St. John the Baptist in the church of All Saints during all service hours on feast days. Two wardens managed the affairs of the brotherhood and probably made the collections, which were its sole source of revenue. The association was perhaps one of friends, for in 1346 five of the brethren were dead and no effort had been made to fill their places, nor were the survivors bound by any oath.¹² The contemporary gild of the Blessed Mary of Barkway was also devotional in character, but was joined by both men and women. Here, too, continuity was evidently not anticipated, for five lights before the image of the Virgin in the parish church were to be maintained only while ten brothers and sisters remained alive. The great aim of the gild was not, however, the support of these lights, but the provision of masses in honour of our Lady, and for this each member paid 1*d.* each Sunday. The gild also undertook the ordering of the funerals of its members, paying all expenses if the dead brother or sister had left no goods, and collecting pence among the members for the celebration of a requiem mass.¹³ At Waltham Cross the members of the gild of St. Mary also maintained a chaplain, but they had abandoned the system of weekly payments for an annual subscription of 6*d.* They maintained torches as well as fifteen tapers to burn before the image of our Lady in her chapel there on all Sundays and feast days.¹⁴

The fourth and last Hertfordshire gild for which the 14th century return has been preserved was that of the Holy Sepulchre at Waltham Cross.¹⁵ The brothers and sisters maintained a chaplain to celebrate divine service in the charnel, paying him a yearly salary of 8 marks; the money was raised by a yearly subscription of 13*d.* The charnel seems to have been wholly in the care of the gild, for the members kept it in repair and maintained there fifteen tapers and two torches burning during service on feast days and Sundays throughout the year. But this was not the end of their activities; they found fifteen tapers to burn about the Easter sepulchre in the parish church, and eight torches at the elevation of the Host at the

¹¹ Exch. Misc. file 12, no. 4.

¹² Chan. Misc. file 39, no. 65.

¹³ Ibid. no. 64.

¹⁴ Ibid. no. 66.

¹⁵ Ibid. no. 67.

ECCLESIASTICAL HISTORY

high altar on all Sundays and festivals. For members of their own company fifteen tapers were burnt at the death-bed and in the church at the funeral, while alms were given to a number of poor.¹⁶

Curiously enough no further reference to any of these guilds has been found, and possibly they, like the guilds of St. Alban, the Holy Trinity and St. John the Baptist at St. Albans,¹⁷ were suppressed by the authorities for actual or suspected dealings in sedition.

Little is known of the Hertfordshire guilds during the first half of the 15th century. A good instance of the incorporation of a guild is found in that of the Blessed Virgin in the church of St. Andrew, Hitchin, constituted under a master and two wardens by licence of 1475.¹⁸ At Hitchin this corporation did not apparently become the centre of town life as did the guild of All Saints at St. Albans under pressure of the struggle between the abbey and the town,¹⁹ and indeed at no other place in the county were conditions favourable for the development of the guild into the municipality. At Bishop's Stortford, where the guild of St. John the Baptist was founded in 1484-5,²⁰ the Reformation brought no loosening of the authority of the Bishops of London, while at Hatfield, Berkhamstead and Ware the guilds seem to have been comparatively unimportant.

The difficulty of estimating the number of guilds and fraternities existing in the 16th century is considerable. Many had no endowments and were maintained by collections and the casual bequests by which their names have been preserved. At Tring, for instance, there was in 1533 a guild of the Blessed Trinity.²¹ St. John the Baptist was the patron of the guild of Ashwell²² and of that at Berkhamstead, which was endowed with the lands afterwards granted to Dean Incent for his grammar school there.²³ At Stevenage the guild of the Holy Trinity had, in common with most guilds, a 'brotherhood-house'²⁴; the fraternity of the Name of Jesus at Baldock²⁵ also had lands and was of some importance.

Harmless as these associations may appear they were undoubtedly viewed with suspicion by the State, and in 15th-century licences for the formation of guilds it was usual to insert clauses intended to prevent the use of the fraternity for political ends. The nature of the connexion between the political and religious movements of the late 14th and early 15th centuries has long been the subject of debate, and it is not proposed to enter into the subject in this place. The fact that John Ball had incurred excommunication and had refused to come into obedience within forty days²⁶ on at least three occasions is no proof of Lollardy,²⁷ though it points to a stirring and disdainful state of mind such as might be expected in a leader of rebellion.

To the townsfolk of St. Albans, struggling to obtain borough liberties, the contrast between the profession of the head of that Benedictine house and his actual position as a great landlord can hardly have failed to be a

¹⁶ Chan. Misc. file 39, no. 67.

¹⁸ *Cal. Pat.* 1467-77, p. 542.

²⁰ Glasscock, *Rec. of St. Michael's*, 118.

²² Archd. of St. Albans Wills, Wallingford, 118, 120.

²⁴ P.C.C. 15 Horne (Will of William Matthew); Pat. 5 & 6 Phil. and Mary, pt. iii, m. 11.

²⁶ Archd. of St. Albans, Wills, loc. cit.; P.C.C. 11 Adeane (Will of Robert Stanford); Aug. Off. Misc. Bks. lxviii, fol. 270 d.

²⁸ Chan. Significations of Excommunication, file 10.

¹⁷ See *V.C.H. Herts.* ii, 480.

¹⁹ See *V.C.H. Herts.* ii, 480-1.

²¹ P.C.C. 3 Hogen (Will of William Tattorne).

²³ Salmon, op. cit. 124.

²⁷ cf. Urwick, *Nonconformity in Herts.* 26.

A HISTORY OF HERTFORDSHIRE

subject for sarcasm. Oldcastle had friends in the place, and rumour went that the Lollards designed to destroy this abbey with that of Westminster, the canons of St. Paul's and all the friars of London.³⁸ In confirmation of this it was reported in 1414 that among the belongings of William Murlee, of Dunstable, who was burnt in that year, was found a list of the names of all the monks of St. Albans,³⁹ obtained with a view to wiping them out.³⁰ Stories and suspicions such as these were bound to strengthen the public uneasiness, which was increased rather than lessened by the action of the Church. Archbishop Arundel issued a mandate for the making of processions and litanies on Mondays, Wednesdays and Fridays for the suppression of heresy, and this was promulgated by the Bishop of London at Much Hadham in January 1413-14.³¹ Those in the diocese of Lincoln were admonished soon afterwards to abstain from being present at preaching at unaccustomed places and times.³² With such advertisement it was not surprising to find a widespread curiosity as to the tenets of the Lollards, and this, more than actual acceptance of their views, may account for the distribution of their tracts 'in every large house or inn' of St. Albans, Northampton and Reading.³³ At St. Albans, Oldcastle certainly had definite adherents, for he hid in the house of a countryman and tenant of the abbey. News of his presence leaked out, and the abbot's household made an attempt to arrest him, but merely succeeded in capturing his companion. At the house they found various books, in some of which the illuminated figures of the saints had been defaced.³⁴ There were, moreover, English books among them such as those found at a later date among the belongings of John Galewey, of the exempt jurisdiction of St. Albans.³⁵ Galewey was a parchment maker, a trade which seems to have numbered many Lollards among its members³⁶; he was cited before the spiritual court and excommunicated; possibly he abjured, for no further record of the case has been found.³⁷ In the beginning of 1426-7 rumour was busy with the names of various persons dwelling within the abbot's jurisdiction and said to be enemies of the faith. A synod was accordingly held in the church of St. Peter at St. Albans.³⁸ Ordinances were issued against false preachers, and incumbents were warned against permitting any to preach unless licensed or expressly sent for the purpose.³⁹ A further ordinance was directed against the reading or possession of suspicious books in the vulgar tongue.⁴⁰ The three suspected persons were then examined. Two sought purgation; the third, William Redhed, 'malt man' of Barnet, had owned the books and made public abjuration.⁴¹

How solemn a thing abjuration was made can be gathered from that of Thomas Hulle of Hertford. There in the church of All Saints one day in June 1457 he appeared before the bishop himself and confessed that he had

³⁸ Walsingham, *Hist. Angl.* (Rolls Ser.), ii, 298.

³⁹ *Ibid.* 299.

³⁰ 'Quos ut fertur eliminasse proposuerat.'

³¹ *Hist. MSS. Com. Rep.* ix, App. 57.

³² Linc. Epis. Reg. Repingdon, Memo. fol. 158.

³³ Walsingham, *op. cit.* ii, 317.

³⁴ *Ibid.* 326.

³⁵ Wills of the Archdeaconry of St. Albans, Stoneham, fol. 73 d. The document is not dated, but is found with others of 1428-30.

³⁶ cf. Gairdner, *Lollards and the Reformation in Engl.* i, 93 and n.; Devon, *Issues of the Exch.* i, 330-2.

³⁷ His name does not occur among the Chancery Significations of Excommunication within the abbot's jurisdiction.

³⁸ Amundesham, *Annales Mon. S. Albani* (Rolls Ser.), i, 222.

³⁹ *Ibid.* 224.

⁴⁰ *Ibid.* 224-5.

⁴¹ *Ibid.* 227.

ECCLESIASTICAL HISTORY

‘geven ayde, consell, help and favour unto oon Thomas Curteys to thentent that he exercised and used nigromancy and heresy. Wherefore,’ he went on, ‘I abiure and forswere alle maner of heresies and errors and promyt that I shal never in tyme to come gef ayde help favour nor socour nor counsell to any that holdeth heresies or useth nigromancy in tyme to come.’⁴² Although almost equal stress is here laid on magic and on heresy,⁴³ it is probable that Hulle and Curteys were wizards rather than Lollards, their sin lying in practice rather than opinion. How distorted the doctrines of the Lollards might become in the rural mind may be judged from the views of a butcher and a labourer of Standon who in 1452 were indicted for heresy.⁴⁴ According to their neighbours, John Gable and John Curteys on 20 July of that year voiced opinions against the Catholic faith and Holy Church. There was no god, they maintained, but the sun and the moon; the child born of human parents had no need of baptism, nor should any Christian pay honour to any image in a church.⁴⁵ The fate of these men is not known, but no intimation has been found of their failure to render obedience to the bishop of the diocese. Although the heretics might abjure when brought before the courts, there must have been many cases of unorthodoxy that passed unnoticed. Nor can the records be complete, for no cases are found as having come before William Albone, William Wallingford and John Werdale, whom Wheathampstead in August 1464 appointed commissioners for the examination of heretics within the jurisdiction of the abbey of St. Albans.⁴⁶ In March 1476-7 Wallingford, as abbot, himself appointed the prior, the archdeacon, the cellarer and two other officials to examine heretics, and especially Henry Dyer of St. Albans.⁴⁷

The only other instance of heresy found in the western half of the county was that of William Barou of Walden in the diocese of London. He was accused of heresy, confessed, abjured and then again fell into error. Bishop Kemp thereupon declared him a relapsed heretic, and in July 1467 notified the Crown to this effect, calling on the civil power to execute judgement⁴⁸; Barou must have been burnt. Such, also, must have been the fate of three men ten years later; John Hoddesdon of Amwell, William Browne of Ware and Peter Boore, who had moved from Ware to Brentford, were declared to be relapsed heretics and as such worthy of death in July 1477.⁴⁹ It would seem from the form of the notification that they were associated in their heresy, but no further mention of them has been found, though they, too, doubtless paid the full penalty for their error.

Fragmentary as is the evidence, it seems to point to the conclusion that Lollardy never became widespread in Hertfordshire. At St. Albans, the most favourable centre, civil and ecclesiastical authority were united in the hands of the abbot, who had every interest in its suppression and was loyally served by his officials. From over the Buckinghamshire border, where heresy was strong, infection was bound to spread, but the cases were

⁴² Linc. Epis. Reg. Chedworth, Memo. fol. 14.

⁴³ cf. *ibid.* Alnwick, Memo. fol. 76.

⁴⁴ Anct. Indictments, K.B. 9, file 40, m. 4.

⁴⁵ *Ibid.*

⁴⁶ ‘Whethamstedes Reg.’ *Reg. of St. Albans* (Rolls Ser.), ii, 22.

⁴⁷ *Ibid.* ii, 164. No further details concerning Dyer have been found. His name does not occur among the Chancery Significations of Excommunication.

⁴⁸ Chan. Significations of Excommunication, file 125. This and the following instance have been kindly communicated by Miss E. J. B. Reid.

⁴⁹ *Ibid.*

A HISTORY OF HERTFORDSHIRE

sporadic.⁶⁰ Similarly, also, the instances at Ware and Standon should probably be traced to the activity of the Lollard teachers of Essex. It is notable that, except for some parochial gossip at Hitchin in 1518-19,⁶¹ no more is heard of heresy in Hertfordshire until the Reformation period.

The 16th century brought with it those changes that eventually produced the Church of England as it exists to-day. What various causes contributed to the success of the movement towards reform, how much influence can be ascribed to Lollard and Humanist, how much to economic conditions, are points as difficult to determine as the extent of popular acquiescence or movement in the change. Difficult as it is to ascertain the general attitude towards the Church on the eve of the Reformation, the condition of the churches themselves in one part of Hertfordshire can be determined with some precision.

The articles of the inquiry made by Bishop Atwater in 1518-19⁶² do not seem to have been preserved, but they would appear to have dealt mainly with the residence of the clergy, the letting of benefices and the condition of the fabric and ornaments of the parish churches. At Hertingfordbury, where the rectory was let to a layman, the obligation of the rector to repair the chancel had been ignored just as it had been at Pirton, where, too, the churchyard, the rector's freehold, was not properly inclosed. At Ardeley the chancel was ruinous, but the rector seems to have been resident.⁶³ It may be that the word 'ruinous' has in these returns a purely technical meaning, but that something more than repairs was needed in these cases seems evident from other entries. Thus at Little Wymondley the glass windows in the chancel were broken, at Bayford the windows were ruinous and at Ickleford the glass windows of the nave were broken and the lead of the chancel roof defective. At Knebworth the tiling of the chancel was in bad repair. Much the same tale is told with regard to ornaments. At Offley the almost incredible statement is made that the vicar had no vestment in so far⁶⁴ as alb, chasuble and fannel were concerned; the cause of this deficiency is perhaps implied in the remark that 'the vicar for the most part serves at a hospital.' That this was not a unique instance is shown by the fact that at Graveley there was no alb, alb cloth, or portiforium, but the cure was not served by the rector in person. At King's Walden, where the incumbent was perhaps non-resident,⁶⁵ they had no 'reasonable' albs; at Ickleford the surplice was not as it should have been. Much the same story was told of Letchworth, where the rector was non-resident, the curate inefficient and the books in need of repair.

With this report may be compared that made in 1530.⁶⁶⁻⁷ The parishioners of Gaddesden presented that their rector resided on another benefice in Bedfordshire, and that the chancel was ruinous. The church of Aldenham belonged to the Abbot and convent of Westminster, but they too had failed to fulfil their obligations and the chancel was much ruined; that it was

⁶⁰ Among those who abjured in 1511 were Andrew Randel of Rickmansworth, his wife and father, Thomas Clerke and his wife of Ware, and 'one Geldener about Hertford' (Foxe, *Acts and Monuments* [ed. 1846], iv, 226).

⁶¹ Atwater's Visit. 1518-19 (Linc. Epis. Reg.).

⁶² *Ibid.*

⁶³ Thomas Bray was resident vicar here in 1526 (Salter, *op. cit.* 178).

⁶⁴ 'Usque.'

⁶⁵ In 1526 it was in charge of a curate (Salter, *op. cit.* 176).

⁶⁶⁻⁷ Visit. of Archd. of Huntingdon, 1530 (Linc. Epis. Reg.).

ECCLESIASTICAL HISTORY

otherwise neglected according to modern ideas seems evident from the fact that Robert Marshall,⁵⁸ the vicar, had been non-resident for the past ten years. The abbey of Westminster, impropiator of Ashwell, in spite of the return of 1518-19, cannot have undertaken any considerable repairs to that church, for the parishioners now complained that the chancel was in such a state that the rain dripped down upon the high altar. The rector of Therfield was non-resident and a wall was in ruins. The chantry chapel at Albury was badly in need of repair, but the duty probably devolved on the patron, and at Totteridge, where the parishioners were responsible, the churchwardens were ordered to repair the ruinous chapel against Michaelmas following.

Presentments such as these seem to have had good results, for only one of the churches needing repair in 1530 was so returned in 1543.⁵⁹ The exception was Aldenham. The rectory had passed into the hands of a 'farmer,' Robert Duncombe, who apparently did nothing for the church, for the chancel was in great ruin and need of repair, and the churchyard was badly inclosed so that the beasts got in, nor would he repair 'les mowndes' there. The neglect of Ardeley Church by the Dean and Chapter of St. Paul's was perhaps due to the uncertainty of the times; moreover, the chancellor had sequestered the issues and the vicar was non-resident. The churchwardens described the chancel as in the greatest ruin. Perhaps it was politics, too, that were responsible for the neglect of the chapel of Flamstead. The chantry priest at this date was Stephen Garrett, but he had let it at farm, and neither lived there nor celebrated mass within its walls. It is, perhaps, allowable to anticipate at this point and to compare these returns with that made at Cardinal Pole's metropolitical visitation of the Lincoln diocese in 1556.⁶⁰ The chancels of the churches of Rushden, Great Wymondley, Kensworth and Gaddesden were all ruinous, and the priests in each case were sequestered. The chapel at Bayford was also in great need of repair.⁶¹ It is, indeed, only by side-lights such as these that any estimate can be made of the effect of the religious changes of the reign on the people at large. Even these were exceptional cases of want of parochial care, and in the absence of complaints from the much larger proportion of churches it may be assumed that they were satisfactorily served.

The suppression of the religious houses led in Hertfordshire to no outbreak of rebellion such as that in Yorkshire or Lincolnshire. Between 1536 and 1539 the religious left their old homes without riot, and it seems probable that many of the Hertfordshire religious houses had been quietly dissolved before this date.⁶² In July 1537 St. Albans and Hertford were considered suitable resting-places for Henry VIII and his train on their way to Hunsdon,⁶³ and no mention of discontent in the county has been found. The Crown had taken the place of the Papal See as supreme authority in matters ecclesiastical, and in February 1538-9 Henry issued his proclamation concerning the rites and ceremonies to be used in the Church of England.⁶⁴ That the changes of this time were looked upon as the excuse for relaxation of

⁵⁸ cf. Salter, *op. cit.* 171. This return shows that there were a curate and two stipendiaries serving in the church.

⁵⁹ Visit. of Archd. of Huntingdon, 1543 (Linc. Epis. Reg.).

⁶⁰ Strype, *Ecc. Mem.* ii (2), 404.

⁶¹ *Ibid.*

⁶² See above.

⁶³ *L. and P. Hen. VIII*, xii (2), 275.

⁶⁴ Lond. Epis. Reg. Bonner, fol. 28 d.

A HISTORY OF HERTFORDSHIRE

ecclesiastical discipline seems probable, for in April 1541 measures were taken in the diocese of London to discover those who had failed to make the usual confession to their parish curate during Lent.⁶⁶ The Government attitude towards religious observances at this time may be judged from the injunctions to the clergy issued by Bonner in 1542.⁶⁶ One article deals with the habit of 'persons of naughty life' of confessing to priests who had no cure of souls; henceforth no testimonials of confession issued by unbeneficed clergy were to be accepted, and the delinquents were to be refused the communion until they had made confession to their own curates. Other clauses forbade privy contracts of marriage, and this must have formed the basis of one of the articles in the diocesan visitation of the following year, when two persons at Graveley were presented for having married 'de verbo.'⁶⁷ The injunctions also provided that the marriage of persons previously married should only be performed on the production of a certificate of the death of the former spouse, and for the teaching of children 'to reade Englysshe.' No plays or interludes were henceforth to be given in a chapel or other place where the sacraments were administered, and information was to be given to the bishop's official if any parishioners should enforce such games, interludes or plays. The people were also warned against indulgence in fleshly sins, against swearing and slandering, and 'from talking and Jangelinge in the church speccially in the tyme of dyvine serveyce.' This last fault seems to have been not uncommon. In 1518-19 the churchwardens of Kimpton had actually complained at the visitation that many babies 'laugh, cry and sing in church' in service time,⁶⁸ and in 1543 three men of Stevenage were presented as common chatterers in church.⁶⁹ Finally, the injunctions declared that there was 'a detestable and abhominable custume universally Reynyng in your parysshes the younge people and other yll desposed personnes dothe use upon the Sondayes and hollydayes in tyme of dyvine service and preaching the worde of God to resorte unto Alehouses, and theyre exercyseth unlawfull games with greate swearying, blasphemye and drunkennes and other enormyties.' Persons were not to be admitted to taverns at such seasons nor 'to boulling and drynking.' While the conduct of the laity was thus passed in review, that of the clergy was also prescribed. Priests were not to go in unseemly habit 'with unlawful tonsures, wearing armour and weapons,' nor were they to play unlawful games or frequent alehouses with light company. Every week the curate was to study a chapter of the New Testament,⁷⁰ and he was also to 'exercise himself' in the 'Institutions of a Christian Man.' The non-resident incumbent was required to procure royal licence for plurality and non-residence, and no unlicensed priest might keep the cure in his absence.

The Government was having ample demonstration of the power of the pulpit in London,⁷¹ and the regulations now laid down were particularly stringent as to preaching. Every preacher must have royal or episcopal licence. Twice a quarter curates were to declare what were the seven deadly sins and the nature of the Ten Commandments. The injunctions

⁶⁶ Lond. Epis. Reg. Bonner, fol. 19. ⁶⁶ Ibid. fol. 38; this is partially printed in Wilkins, *Concilia*, iii, 864.

⁶⁷ Visit. of Archd. of Huntingdon, 1543 (Linc. Epis. Reg.).

⁶⁸ Atwater's Visit. 1518-19 (Linc. Epis. Reg.).

⁶⁹ Visit. of Archd. of Huntingdon, 1543 (Linc. Epis. Reg.).

⁷⁰ cf. below, p. 323.

⁷¹ See *V.C.H. London*, i, 283, &c.

ECCLESIASTICAL HISTORY

seem to imply frequent if not weekly preaching. The subjects were to be the value of the sacraments, the meaning of the service and prayers, and, on feast days, the teaching of the particular festival. The preacher was to expound the gospel or epistle of the day, affirming nothing for which he could not show authority in some ancient writer and avoiding rehearsals of any opinion not allowed for the intent to reprove the same; especially was he warned against preaching sermons made by other men during the last 200 or 300 years. The injunctions finished with a list of prohibited books, for the civil and ecclesiastical authorities were striving busily to prevent the spread of reformed doctrines of the Continental type. A proclamation of May 1541 had required all churchwardens to supply themselves with a Bible of the largest and greatest volume to be had in every church by All Saints' Day.⁷² For every month's delay after that feast the penalty was to be 40s., divided equally between the Crown and the informer.⁷³ At least one prosecution for neglect was started, for William Snowe of Aspenden laid information that Percival Lago, the rector, and Thomas Bele, the churchwarden of that place, had, for the period of one whole month, failed to have in the church any Bible in English written or printed. The defendants maintained that the prosecution was vexatious and seem to have established their case.⁷⁴ Although there is nothing in the pleading to indicate that Snowe was of reforming tendencies it is possible that Lago was of the older school of thought, for he was rector of Aspenden in 1526.⁷⁵

Parties were evidently forming even in country parishes by 1543, but there is nothing in the Lincoln visitation of that date to show that the reformers were in favour. At Stevenage a Richard Lawton was presented for not attending service on Sundays and festivals, but only one other case can be put down to what may be called the ecclesiastical politics of the day. On Thursday in Whitsun week Christopher Falconer (Fokener) was celebrating mass in his church of Little Munden. For some reason there was a great disturbance, talking and tumult among the congregation at the most solemn moment of the service, and such was the uproar that his attention was distracted and he failed to elevate the sacrament above his head for the devotion of the people. At the visitation he was charged with this and submitted himself to correction. His public penance was fixed for the following Sunday; after the procession or litany he was to carry in his hand a candle 1 lb. in weight, and then at the time of mass to place it upon the candlestick on the high altar before the elements.⁷⁶

Such monitions show how the old forms of service were still retained in 1543. In June of the next year Henry VIII began his imposition of a new liturgy and 'set forthe certayne godly prayers and suffrages in our natyve Englishe tonge' to be used as a litany.⁷⁷ In 1545 an Act was passed dissolving the chantries,⁷⁸ and in January 1546-7 Henry died. The churchwardens' accounts of Bishop's Stortford throw some light upon the happenings of the next few months. At Easter the usual ceremonies seem

⁷² Wilkins, *Concilia*, iii, 856.

⁷³ Ibid.

⁷⁴ Memo. R. (Q.R.), Mich. 36 Hen. VIII, m. 21 d.

⁷⁵ Salter, *op. cit.* 178.

⁷⁶ Visit. of Archd. of Huntingdon, 1543 (Linc. Epis. Reg.).

⁷⁷ Wilkins, *Concilia*, iii, 870.

⁷⁸ The clergy list appended to the Visitation of the Archd. of Huntingdon for 1543 gives the names of all chantry priests in the Hertfordshire parishes of the Lincoln diocese.

A HISTORY OF HERTFORDSHIRE

to have been performed, the Easter sepulchre was erected and taken down and the common lights tended.⁷⁹ Then came the time of questioning, perhaps coincident with the publication in July of the Injunctions of Edward VI. The clause providing for the removal of all shrines, pictures and monuments of superstition was somewhat vaguely worded; it left, as was perhaps intended, a good deal to the discretion of the churchwardens and local feeling. At Bishop's Stortford the churchwardens in perplexity commissioned John Laxton to hire a horse and ride to London 'for to vew and se other churches ther.'⁸⁰ The result was that on his return men were employed for two days in 'takyng downe of the thyngs in the Roode loft.' With great foresight the churchwardens then sold not merely their two 'tabernacles' but a silver-gilt pax, two pairs of silver-gilt censers with their incense-boat, two massive silver cruets, a silver-gilt cross and stand and two chalices and a paten of silver. The vestments were sold in the following year and made the large sum of £6.⁸¹ The Prayer Book was issued under a royal proclamation of 8 March 1547-8, and the churchwardens bought two copies. The Government contended that the book was no new service, but 'none other but the old . . . the self-same words in English, which were in Latin, saving a few things taken out'⁸²; at Stortford, where there was a choir, the careful churchwardens kept their old books, and with the vicar's consent altered 'the servys hought of lattyne in to Ynglys.'⁸³ This practice was probably widely adopted, for in December 1549 a royal mandate was issued for all the old service books to be called in, burnt, defaced and destroyed.⁸⁴ At Stortford the transposition was unsatisfactory, and in 1550 at least three attempts at a successful rendering were made by the command of the vicars and others, the last being completed in time for use on Trinity Sunday.⁸⁵ Marbeck's *The Booke of Common Praier Noted* appeared in this year, and may have been the 'bowke of the last servys' bought in London; the churchwardens also acquired two psalters, two 'newe bokys . . . calleyd the kyngs boke of the last setting fourth,' and four manuscript 'bookes for to have in the choire.'⁸⁶

Meanwhile royal commissioners were busy in the diocese of London, but only fragmentary notices of their activities have been found.⁸⁷ The commission which sat at Ware on 19 March 1549-50 was no doubt that issued to the sheriffs and justices of the peace for the county on 15 February 1549 to make inventories of the goods of every church and chapel, and was preliminary to the general commission of April 1552.⁸⁸

Edward VI died on 6 July 1553, and on 3 August Queen Mary entered London. One of her earliest acts was to restore Bonner to the see of London, Ridley being lodged in the Tower. The Latin service, though adopted in some cases at an earlier date, was officially brought back into use on 21 December of the same year. The churchwardens' accounts of Bishop's Stortford may again serve to illustrate the changes effected in the church

⁷⁹ Glasscock, *Rec. of St. Michael's*, 46.

⁸⁰ *Ibid.* 47.

⁸¹ *Ibid.* 49.

⁸² Foxe, *Acts and Monum.* (ed. 1846), v, 734.

⁸³ Glasscock, *op. cit.* 51.

⁸⁴ Cardwell, *Doc. Annals*, xx; Stat. 3 & 4 Edw. VI, cap. 10.

⁸⁵ Glasscock, *op. cit.* 51.

⁸⁶ *Ibid.*

⁸⁷ *Ibid.* cf. p. 50.

⁸⁸ *Acts of P.C.* 1550-2, pp. 228, 467; 1552-4, p. 101. The inventories of 1552 are printed by Cussans, *Invent. of Furniture and Ornaments remaining in all the parish churches in Hertfordshire*.

ECCLESIASTICAL HISTORY

before March 1553-4.⁸⁹ The altar had to be 'made up,' the rood made, two crosses, perhaps of wood, were bought, and a cross shaft painted. Both a holy water stoup and a pix were provided, and also 'an elle of cloth for the pixe'; an incense boat cost 16*d.*, and two 'staundes at the highe aulter,' 12*d.* Possibly the vicar himself had the necessary vestments,⁹⁰ for the only other purchase of stuff was of seven ells of holland for the priest's surplice. The prices given for the various articles indicate that no attempt was made to provide more than the cheapest materials, and the only adornment attempted was 'the coloring of the walle' (6*d.*) and the providing of 4 yards of fringe 'and the sowing of y^t upon the sacrament cloth.' Books were, of course, an expensive item: 12*s.* were given to 'Mr. Vicar for a mas bok,' 22*s.* for '3 bokes more,' and 4*s.* 6*d.* for a 'manuell and a proossioner.'⁹¹

There was doubtless much to be done in the diocese of London before it could be restored to any semblance of its old condition. In the diocese of Lincoln Mary's advisers saw that their policy would be ineffective as long as it remained under the guidance of Taylor, and he was accordingly deprived on 15 March 1553-4.⁹² In this same month Mary issued her Injunctions⁹³ directing the bishops to declare deprived 'all such persons from their benefices or ecclesiastical promotions who . . . have married⁹⁴ . . . or otherwise notably and slanderously disordered or abused themselves.' The profits of their promotions were to be sequestrated, but the bishops were desired to use more lenity and clemency to widowers and to such as agreed to a separation by mutual consent.⁹⁵ This last would seem a somewhat precarious arrangement, and it certainly proved so in the cases of John Yngvey and Thomas Goldere, priests living at Kensworth in 1556. According to report the separation was not complete; they were accordingly suspended and fled.⁹⁶ It was perhaps under this rule that four more deprivations in Hertfordshire parishes of the London diocese were made in the first half of 1554. John Synge was deprived at Bushey; his successor Thomas Bentley was instituted on 5 May,⁹⁷ but must have himself died, resigned, or been deprived before the autumn, when George Chapman was rector.⁹⁸ At Broxbourne, also, Thomas Banister, vicar since 1549, was deprived, and the same fate met James Lodge, vicar of Braughing, and Richard Freman, rector of Stocking Pelham.⁹⁹ Before September Thomas Butler, M.A., vicar of Barkway, and Alexander Stooks, vicar of Royston since 1540, had been deprived.¹⁰⁰ Nicholas Browne, B.A., who had been rector of Little Hornead for thirty-seven years, was deprived of this living and allowed to resign his vicarage at Great Hornead.¹ In the diocese of Lincoln the same thing was going on; in May Robert Manners and John Smarte were admitted respectively to the livings of Datchworth and Wallington, both vacant by deprivation.² In August Richard Preston was instituted to Rushden, which was 'by lawful

⁸⁹ Glasscock, *op. cit.* 50-3.

⁹⁰ 'A cloth for the pryst hed' was bought in 1554 (*ibid.* 53).

⁹¹ *Ibid.* 50-3.

⁹² Rymer, *Foedera*, xv, 370.

⁹³ Wilkins, *Concilia*, iv, 89.

⁹⁴ The marriage of the clergy was legalized in Feb. 1548-9 (Stat. 2 & 3 Edw. I, cap. 21).

⁹⁵ Wilkins, *loc. cit.*

⁹⁶ Strype, *Eccl. Mem.* ii (2), 404.

⁹⁷ Newcourt, *Repert.* i, 816.

⁹⁸ *Visit. of Archd. of Middlesex, 1554* (Lond. Epis. Reg.).

⁹⁹ Newcourt, *op. cit.* i, 812, 808, 867. Only one resignation is shown in this period (*ibid.* 864).

¹⁰⁰ *Ibid.* 803, 867. This date is supplied by the Visitation of 1554.

¹ Newcourt, *op. cit.* i, 836, 838.

² *Linc. N. and Q.* v, 228, 229.

A HISTORY OF HERTFORDSHIRE

means vacant.'³ In the late autumn there were more deprivations; Robert Nebbe was turned out of his living of Ayot St. Lawrence,⁴ the rector of Puttenham was deprived, and Thomas Chambers was instituted rector of Westmill, which is merely described as 'vacant.'⁵ Thomas Casse of Digswell was also deprived in this year.⁶

In September 1554 Bonner began his visitation of the diocese of London. The injunctions issued to the clergy provided that no married or heretical priest might hold a benefice, that no priest from another diocese might serve a cure without first producing letters testimonial under the episcopal seal, and that every non-resident must supply a 'sufficient, honest and able Priest' to serve his cure.⁷ While such regulations were aimed at the suppression of the new doctrine among the clergy, provision was also made for the instruction of the parishioners. The desire for sermons was to be met by the reading of homilies on every Sunday and holy day, and at least four times a year the clergy were to 'declare set forth and instruct the proper the true meaning of the ceremonies of the Church'—i.e. of the giving of bread and of holy water, the bearing of candles on Candlemas Day, the giving of hallowed ashes by the priest to the people on Ash Wednesday, the bearing of palms on Palm Sunday, the creeping to the cross on Good Friday, and the bearing of the pax in church during the celebration of mass.⁸ The articles of inquiry⁹ were very minute and postulated that the state of the churches and clergy was the same as in the days of Henry VIII, the legislation of his son's reign being ignored. Unfortunately no return has been found, but some details can be learnt from the clergy list drawn up at this time.¹⁰ The rector of Buckland and the curate of Sawbridgeworth were ordered to produce their letters testimonial, and at this last place John Johnson, priest and schoolmaster, and one Peverell, a priest, were found to have married.

The visitation list is notable as an official statement of the number of livings vacant in this part of Hertfordshire in the last months of 1554. The livings of Barkway and Royston remained vacant until January 1554-5, while that of Little Hormead was not filled until April.¹¹ A vicar of Great Hormead, however, was instituted in October.¹² The vicarage of Hexton was vacant, and the churchwardens of Norton presented that they had had no vicar since Midsummer.¹³ Queen Mary's ordinances¹⁴ had provided that 'where priests do want' the bishops were to take order for the parishioners 'to repair to the next parish for divine service,' or to arrange for one curate to serve several parishes in turn. How far this was carried out in Hertfordshire was not known, but the total number of vacancies was not great and no very serious inconvenience can have been caused. The deprivation must, however, have caused much ill-feeling, and this seems to have been strengthened by Bonner's inquiries and conduct at the visitation. The story told by Foxe¹⁵ of his progress through the county has been frequently repeated and may well represent, even if it does not reproduce, the facts.

³ *Linc. N. and Q.* vi, 9.

⁴ *Ibid.* v, 206.

⁵ *Ibid.* 205, 206, perhaps by resignation.

⁶ *Ibid.* 174.

⁷ *Injunctions given in the visitation of . . . Edmund Bishop of London.*

⁸ *Ibid.*

⁹ The articles are printed in Strype, *Ecc. Mem.* iii (2), 217.

¹⁰ Visit. of the Archd. of Middlesex, 1554 (Lond. Epis. Reg.).

¹¹ Newcourt, *Repert.* i, 803, 838, 867.

¹² *Ibid.* 836.

¹³ Visit. cit.

¹⁴ Wilkins, *Concilia*, iv, 90.

¹⁵ Foxe, *Acts and Monum.* (ed. Townsend), vi, 562-4.

ECCLESIASTICAL HISTORY

The ancient heresy laws, abolished by Somerset, were revived in December 1554, and in 1555 the punishment of death by burning was again enforced. Hertfordshire was singularly free from these dreadful spectacles; it may be that its general conformity with the religious fashion was considered warranty of orthodox faith. On 31 August 'whent out of Nugatt a man of Essex unto Barnett for herese, by the shereyff of Medyllsex, to borne ther'¹⁶; he was William Hale of Thorp,¹⁷ and had no apparent connexion with this county. In the same month Thomas Fust was burned at Ware.¹⁸ Of George Tankerfield, their fellow-martyr, more is known. He was a Yorkshireman under thirty, who had settled in London as a cook.¹⁹ He was arrested on a charge of heresy in February 1555, and was examined and condemned with Hale and Fust.²⁰ He was sent down to St. Albans for execution and was lodged at the Crosskeys Inn. A 'great concourse of people' had come from curiosity to see him, but opinion was divided in his favour.²¹ The execution was not until the afternoon of 26 August, and Tankerfield met death with great resolution; 'there was a certain knight by, who went unto Tankerfield, and took him by the hand and said, "Good brother, be strong in Christ"; this he spake softly; and Tankerfield said, "O sir, I thank you, I am so; I thank God." Then fire was set unto him.'²² The government could not hide from itself the unpopularity of its religious policy and redoubled its efforts at repression. In 1557 royal injunctions were issued to Bonner and his fellow-commissioners to search for heretics and heretical books, to deal with persons who would not attend mass or the litany, and with those withholding goods and lands from the Church.²³ How easy it was to excite suspicion or fall a victim to malice is evident from the order issued to all vicars and curates in April of this year.²⁴ The clergy were directed to make 'the beste and mooste diligente searche ye canne concerninge all and singular persons within every your severall parisshe who obstinatlye at any tyme hearetofore have or hereafter shall commonlye absente thereselves from there severall parisshe churches and in comminge thither doo not heare mattens, masse and even-songe, goo in procession, make there confession to the preiste, receive the blessed sacramente of the altare at any time appointed and accustomed for the same or doo not reverently use the ceremonies of the churche as in takinge hollye breade, hollye water, kyssinge the paxe,' &c. Delinquents were to appear before the bishop.²⁵

On 22 March 1556 Cardinal Pole was consecrated Archbishop of Canterbury,²⁶ and at Easter he began his metropolitanical visitation of the diocese of Lincoln. The discovery of the Dudley conspiracy to kidnap the queen and set Elizabeth on her throne was serving to emphasize the danger of obscure meetings such as the heretics were forced to frequent. All the articles of Pole's visitation,²⁷ with but three exceptions, were accordingly bent towards the discovery of heretics, malcontents, or those disobedient to the ecclesiastical law. The remaining inquiries dealt with the condition of the fabric of the church, chancel and dwelling-house, the insistent question

¹⁶ Machyn, *Diary* (Camden Soc.), 94.

¹⁷ Foxe, *Acts and Monum.* (ed. 1847), vii, 370.

¹⁸ *Ibid.* ¹⁹ *Ibid.* 343.

²⁰ *Ibid.* 370.

²¹ *Ibid.* 345.

²² *Ibid.* 346.

²³ Lond. Epis. Reg. Bonner, fol. 425-6.

²⁴ *Ibid.* fol. 419.

²⁵ *Ibid.*

²⁶ Stubbs, *Reg. Sacrum Angl.*

²⁷ Printed by Strype, *Eccles. Mem.* ii (2), 411.

A HISTORY OF HERTFORDSHIRE

of residence and the number of vacant cures.²⁸ The presentments for Hertfordshire are neither numerous nor important. If they are to be believed as the whole truth the people of this district practised the old religious manners and devotions with little hesitancy. At Hatfield, indeed, Agnes Mery had not received the sacrament at Easter and was put to penance. There was more difficulty about the observance of Candlemas. At Hemel Hempstead Robert Rosse had stayed away from church on that day; at St. Andrews, Hertford, Robert Webbe refused to carry a candle; at Abbots Langley Anthony Bonning did the same, while Alexander Allison told the vicar roundly 'that a wiser vicar than yee will not require them.'²⁹

In the face of presentments such as these it is curious to find that a parish church in December 1557 could lack alb, surplice, light before the rood, the image of the patron saint and a lantern, and that the archidiaconal court imposed the comparatively light penalty of 40s. should these not be obtained by Christmas Day.³⁰ Yet this was the state of affairs at Bushey. At Newnham³¹ even more necessary things seem to have been wanting, but both here and at Norton the churchwardens were given until the Annunciation to make good the deficiencies.³²

Queen Mary did not live another year, and with her death came the restoration of the English service and the reformers' triumph. By Elizabeth's Injunctions³³ issued in 1559 no altar was to be 'taken down but by the oversyght of the curate of the church, and the churchwardens, or one of them at the least, wherein no riotous or disordred maner to be used'; moreover, 'the holy table in every church' was to 'be decently made and set in the place where the altar stood, and there commonly covered as thereto belongith, and as shall be appointed by the visitors.' At Bishop's Stortford the altars stood until at least March 1558-9, and the rood-loft remained for another year.³⁴ Indeed, although many of the rood-lofts were then destroyed, the general order for their destruction was not given until 1561,³⁵ when the archdeacon directed that the rood-loft at Bushey must be destroyed before the following September.³⁶

On the question of the clerical deprivations at the beginning of the reign of Elizabeth the evidence is unfortunately inconclusive. It has been recently remarked³⁷ that owing to the break in the registers for the diocese of Lincoln no less than thirty-five Hertfordshire parishes 'show lacunae in the lists of their incumbents just for this period' of 1559-71, but the estimate of the number of deprivations must necessarily be imperfect.

The Act of Supremacy received the royal assent on 8 May 1559,³⁸ while the Act of Uniformity³⁹ passed its third reading on 28 April and came into force on 24 June of that year. To these as an exposition were added the Royal Injunctions drawn up by Cecil.⁴⁰ The visitation at which these were promulgated followed the precedent of 1547, and was essentially civil

²⁸ For the reports on the fabric see above, p. 311; the last two questions seem to have been ignored (Strype, op. cit. ii [2], 404, &c.).

²⁹ Strype, loc. cit.

³⁰ Hale, *Precedents in Causes of Office*, 78.

³¹ Ibid.

³² Ibid. 77.

³³ *Injunctions given by the Quenes Maiestie*, 1559.

³⁴ Glasscock, op. cit. 54.

³⁵ Gee, *Elizabethan Prayer Book*, 175 n., 186.

³⁶ Hale, *Precedents in Causes of Office*, 78.

³⁷ Birt, *The Elizabethan Religious Settlement*, 199.

³⁸ Stat. 1 Eliz. cap. 1.

³⁹ Ibid. cap. 2.

⁴⁰ *Injunctions given by the Quenes Maiestie*, 1559; Gee, *Elizabethan Clergy*, 41-70.

ECCLESIASTICAL HISTORY

in character. It was conducted by commissioners; those for the diocese of London included eighteen laymen, local interest being represented by Sir Ralph Sadleir of Standon. For Hertfordshire the visitors sat at Bishop's Stortford.⁴¹ Dealing with the Church from the point of view of order the questions put were not generally concerned with doctrinal points, the most important in this respect being that which inquired whether the clergy ministered 'the Holy Communion in any other wise than after such form and manner as is set forth by the common authority of the queen's majesty and the Parliament.'⁴² The form of the question opened up serious difficulties, but the recent course of events had made even the Marian clergy recognize the power of the Crown in matters ecclesiastical. Nevertheless, only nineteen out of twenty-nine beneficed clergy in the parishes within the archdeaconry of Middlesex subscribed.⁴³ These results show that the clergy were not prepared for the changes wrought, had not indeed yet decided as to their import. Such a result was not satisfactory to the Government, and William Chedsey, who had been made Archdeacon of Middlesex in 1556, was deprived in 1560. Chedsey had from the first been strongly opposed to the new movement, and in 1559 had taken part in the Westminster Disputation, the other representatives of the old learning being Watson, Bishop of Lincoln, Scott, Bishop of Chester, Bayne, Bishop of Coventry and Lichfield,⁴⁴ White, Bishop of Winchester, Henry Cole, Dean of St. Paul's, Nicholas Harpsfield, Archdeacon of Canterbury, and Alban Langdale, Archdeacon of Lewes. The removal of John Dugdale, Archdeacon of St. Albans since 1557, and of Anthony Draycott, Archdeacon of Huntingdon since 1543, placed the clergy throughout this county under men whose sympathies were with the reformers. The new Archdeacon of Middlesex was Alexander Nowell, son of a Lancashire squire and one of the best scholars that Oxford had given to the advanced school of the day. As a prebendary of Westminster he had received licence to preach in 1551, and had soon been forced to leave the country. Though an exile in Strasburg and Frankfort he did not join the extreme party,⁴⁵ and on Elizabeth's accession he returned to England. His moderation and scholarship recommended him to Cecil, and in 1559 he was one of the two clerics who with twenty-nine laymen visited the dioceses of Lincoln, Oxford, Peterborough and Coventry and Lichfield.⁴⁶ Thus when appointed archdeacon in 1560 he had a full knowledge of current opinion among the local clergy.

One of his first proceedings must have been the deprivation of Richard Kingston, pluralist rector of St. Anne and St. Agnes, London,⁴⁷ and of Aldenham. Kingston had not subscribed in 1559, but he alone of the Hertfordshire clergy seems to have been deprived immediately. The next victim was John Bartlett, vicar of Bishop's Stortford. Bartlett was probably well known as an adherent of the old forms, for he had been collated to the living by Bonner in 1559 on the deprivation of Richard Fletcher.⁴⁸ He

⁴¹ Gee, *op. cit.* 96.

⁴² *Ibid.* 67.

⁴³ *Ibid.* 102 et seq., where the lists for the dioceses of London and Lincoln are printed. That for London is probably complete, that for Lincoln is certainly defective. There are, however, ninety-five subscribers whose preferment is not specified.

⁴⁴ Strype, *Annals*, i (1), 128-9.

⁴⁵ cf. *A Brief Discours off the troubles begonne at Franckford in Germany.*

⁴⁶ Strype, *Annals*, i (1), 247.

⁴⁷ Hennessy, *Novum Repert.* 95.

⁴⁸ Newcourt, *Repert.* i, 896.

A HISTORY OF HERTFORDSHIRE

subscribed in 1559,⁴⁹ but must have repented, for his successor, Thomas Sympson, was instituted in March 1560-1.⁵⁰ To these names must be added that of G. Bullock, whose successor was instituted to Munden in 1560.

Later in this year a visitation was held in the deanery of Braughing,⁵¹ where the old learning appears to have been particularly strong. Of the thirty-two livings within the deanery three were vacant; there were thus twenty-nine incumbents answerable, and of these three were absent,⁵² presumably for reasonable cause, and four refused to put in an appearance. These four were John Bendall, vicar of Ware, Richard Cotton, vicar of Braughing, John Hopper, rector of Reed, and Robert Yngham, rector of Stocking Pelham. The position of Ware on the Great North Road and its commercial activity made the living of considerable importance, and it was obviously necessary that the incumbent should conform with the laws. The living belonged to Trinity College, Cambridge, which had presented Bendall in 1559.⁵³ He subscribed in the same year,⁵⁴ but in 1561 he refused to make an appearance. Pressure was probably brought to bear upon him, and he must have conformed, for in November⁵⁵ he was instituted to the vicarage of Latton, and in 1563 became rector of St. John the Baptist, Dowgate.⁵⁶ The case of Richard Cotton of Braughing proved more serious. In July 1554, on the deprivation of James Lodge, the cure was given to Nicholas Aspinall. He subscribed in 1559,⁵⁷ but resigned this living at the end of the year,⁵⁸ possibly on promotion, for in 1562 he was instituted to the living of Stepney, of which he was deprived two years later.⁵⁹ His successor at Braughing was probably much of his way of thought. Richard Cotton was instituted in December 1559,⁶⁰ though his name appears on none of the extant lists of subscriptions. No comment appears in the visitation list,⁶¹ but his name has been crossed out and that of William Lyon written above. William Lyon was instituted 14 October 1562⁶² on the deprivation of Richard Cotton. He was probably well known as a 'safe' man, and already enjoyed important preferment, having been rector of Mile End since August 1560 and of Holy Trinity, Colchester, since February 1561-2.⁶³ John Hopper, unlike Cotton, was a graduate; he was instituted to the living of Barkway in January 1554-5⁶⁴ on the deprivation of Thomas Butler, and was thus probably strong in his opposition to the new movement. In 1556 he became rector of Reed, holding both livings. He subscribed in 1559,⁶⁵ but failed to put in an appearance at the visitation of 1561,⁶⁶ when he was noted as a pluralist. His deprivation followed, but it is noteworthy that here as at Braughing no institution was made until the autumn of 1562,⁶⁷ and it is possible that pluralism rather than recusancy was the cause, for

⁴⁹ Gee, op. cit. 103, where the name is given as 'T. Bartleton.' ⁵⁰ Newcourt, *Repert.* i, 896.

⁵¹ Visit. of Grindal, 1561 (Lond. Epis. Reg.). No indication of the actual date is given.

⁵² Those absent were John Barnes of Wymondley, — Dobbinson of Barley and William Preston of Hunsdon; they all retained their livings. Preston was instituted in 1557 and Dobbinson in 1559 (Newcourt, *Repert.* i, 800, 840).

⁵³ Ibid. ii, 904.

⁵⁴ Gee, op. cit. 103.

⁵⁵ Newcourt, *Repert.* ii, 367.

⁵⁶ Ibid. i, 372. Robert Kaye was instituted to Ware in December 1567.

⁵⁷ Gee, op. cit. 124.

⁵⁸ Clutterbuck, *Hist. and Antiq. of Herts.* iii, 157.

⁵⁹ Gee, op. cit. 253. Nicholas Aspinall was rector of Little Horstead and of Ealing in 1576 (Lambeth MS. xii, no. 1).

⁶⁰ Clutterbuck, loc. cit.

⁶¹ Visit. of Grindal, 1561 (Lond. Epis. Reg.).

⁶² Clutterbuck, loc. cit.

⁶³ Newcourt, *Repert.* ii, 420, 182.

⁶⁴ Ibid. 803.

⁶⁵ Gee, op. cit. 105.

⁶⁶ Visit. of Grindal, 1561 (Lond. Epis. Reg.).

⁶⁷ Newcourt, *Repert.* ii, 862.

ECCLESIASTICAL HISTORY

Hopper seems to have retained his living of Barkway for some time longer, as his successor there was not instituted until March 1563-4⁶⁸ 'on the resignation of John Hopper.' It seems probable, however, that the patron of Barkway was in favour of the old rather than the new learning, for the new vicar, Thomas Chambers, was deprived, his successor being instituted in 1565.⁶⁹ The only other recalcitrant person was Robert Yngham, who was instituted to the living of Stocking Pelham in 1559,⁷⁰ but evidently hesitated in 1561; that his objections were overcome may be inferred from the fact that he retained the living until his death some eighteen years later.⁷¹ To these five deprivations must be added that of Robert Manners, parson of Watton at Stone and prebendary of Lincoln. In 1562 he was described as an 'unlearned priest' and was confined to Baldock 'or within twenty miles compass about the same'⁷²; but of his case, as possibly of others in the archdeaconry of Huntingdon, no details are procurable owing to the gaps in the Registers. While such returns as exist lack many of the details supplied from other archdeaconries, the return of vacant livings made in 1565 mentions only three Hertfordshire benefices⁷³; the rectory of Throcking had been vacant for four years and was served by a curate; the vicarage of Little Munden had been vacant for two months, the patron was not known and the fruits were yet untaken; while at St. Ippollitts the vicarage, in the gift of Trinity College, Cambridge, had been vacant for a year, and the parishioners were taking the fruits for the use of the curate. In no case is the cause of vacancy stated.

In the absence, therefore, of evidence to the contrary, it must be assumed that the majority of the Marian clergy in this county accepted the Elizabethan settlement. That there was a great deal of 'movement' at this time is undeniable,⁷⁴ but its cause should probably be sought in directions other than that of sympathy with the old order. From 1564, indeed, the non-conformist generally looked to Geneva for guidance, though Whitehall was the only authorized director. From the beginning Elizabeth and her councillors recognized the danger of the advanced views advocated by the returned exiles, who on their part took full advantage of the popular reaction. The growth of Puritanism in Hertfordshire during the first twenty years of Elizabeth's reign is not easy to trace owing to the lack of visitations for that period, but Puritanism was probably the cause of certain deprivations. The rector of Radwell was deprived and Benjamin Chambers admitted in March 1571-2⁷⁵; in March 1573-4 the church was again vacant by the deprivation

⁶⁸ Newcourt, *Repert.* ii, 803.

⁶⁹ Gee, *op. cit.* 290. Thomas Chambers, rector of Westmill some years later, refused to subscribe to the Articles (Lambeth MS. xii, no. 2). ⁷⁰ Newcourt, *Repert.* i, 867.

⁷¹ *Ibid.* In 1576 he was described as grave, a priest, of no degree and but slightly acquainted with Latin or theology (Lambeth MS. xii, no. 1).

⁷² Gee, *op. cit.* 182.

⁷³ S. P. Dom. Eliz. Add. xii, 108. Of the seven other vacancies in the archdeaconry six were in the patronage of the Crown.

⁷⁴ A list of 1592 for the archdeaconry of St. Albans (*Rec. of the Old Archd. of St. Albans*, 82-8) shows that of its twenty-three clergy one had been instituted in each of the years 1560, 1572, 1574, 1581, 1582, 1584, 1586 and 1587, two in 1588, 1589 and 1590, three in 1591 and 1592. The only representative of the old order was John Amery, vicar of Codicote, instituted 1546. The vicar of Redbourn would produce no instruments. Of the twenty-nine clergy in the deanery of Braughing in 1561 (*Visit. of Grindal*, 1561 [*Lond. Epis. Reg.*]) ten were returned as benefited in 1576 (Lambeth MS. xii, no. 1).

⁷⁵ *Linc. Epis. Rec.—Bp. Cooper*—(Linc. Rec. Soc.), 327.

A HISTORY OF HERTFORDSHIRE

of the Puritan⁷⁶ Thomas Hewlet⁷⁷ (*sic*) or Hewett. The rectory of Cottered was sequestrated in April 1574 on the deprivation or cession of Florentius Stephenson.⁷⁸ The rector of Aspenden was deprived before May 1575.⁷⁹ In January 1579–80 the vicarage of Hemel Hempstead was vacant through the cession of John Gibson,⁸⁰ and the living was given to Richard Gawton, afterwards well known as a Puritan leader.⁸¹ In March 1582–3 Thomas Noble, M.A., was admitted vicar of All Saints', Hertford, then vacant by the cession of George Turner.⁸² In a visitation of the archdeaconry of St. Albans in 1574⁸³ Thomas Holden, vicar of St. Peter's, is the only incumbent stigmatized as a 'schismatic.' That he was merely a Puritan of somewhat advanced views may be adduced from the fact that in 1586 he was a commissioner for the examination of unlearned ministers.⁸⁴ The other schismatics mentioned in this return were Nicholas Colborne of Watford and Philip Golde of Rickmansworth, neither of whom appears to have been a member of either university or in orders. Philip Golde denied the accusation. The very fact of their presentment seems to demonstrate, however, that Puritanism had not yet gained a general hold upon the people.

But though this part of the country seems to have been little disturbed,⁸⁵ elsewhere the new ideas were causing much anxiety to the authorities of both Church and State. The advanced party had quickly put the Government on the defensive. Though the Puritans in the Lower House of Convocation had been defeated in 1563 on proposals in various matters of order, their denunciations were by no means confined to the signing with the cross at baptism, the kneeling at the administration of the communion or vestarian matters. One of the defeated proposals had been for the abolition of dispensations for pluralities and non-residence.⁸⁶ A 'supplication' to the queen made at the beginning of her reign complains also of cures being held by those that 'yet be of perverse and corrupt judgement and not hitherto reformed,'⁸⁷ of 'the placing and admittance of Parsons, Vicars and of other Ecclesiastical ministers to have special cure and charge of our soules which be so ignorant in all the holie scripture . . . that they cannot instruct and teach us,' and further of 'the admittance of such to have cure of soules, which be learned onelie in the Civill and Canon Lawes.'⁸⁸ There can be no doubt that dispensations and clerical ignorance were serious evils, and the Puritans were probably backed by public opinion in their efforts at reform, for it is noticeable that while at the beginning of the reign questions

⁷⁶ Strype, *Annals*, i (1), 512.

⁷⁷ *Ibid.* 67. There is, perhaps, some confusion here.

⁷⁸ *Ibid.* 67, 110. He had been instituted in April 1567 (*ibid.* 328 n.).

⁷⁹ *Ibid.* 68.

⁸⁰ *Ibid.* 70.

⁸¹ *Ibid.*; Urwick, *Nonconformity in Herts.* 426.

⁸² *Linc. Epis. Rec.—Bp. Cooper—(Linc. Rec. Soc.)*, 72.

⁸³ Visit. 1574 (*Lond. Epis. Reg.*).

⁸⁴ *Rec. of the Old Archd. of St. Albans*, 53.

⁸⁵ A curious incident at Watford throws some light on the general feeling at this time. In November 1575 the churchwardens, schoolmaster and sacristan were summoned before the archdeacon to explain how the font had been pulled down. They declared that they had not noticed it. The case was adjourned for inquiries, which were especially to be made by Nicholas Colborne 'because he kept the schole in the church.' One witness declared that 'beinge in the church with the vicar he perceyved that the font was ryven and in decay where upon he tould the same unto the vicar, then the vicar came to it and stirred it with his hand.' Before 24 November 1575 the font had been restored (Hale, *Precedents in Causes of Office*, 79). Henry Edmunds was then vicar (Urwick, *op. cit.* 348; cf. *Rec. of the Old Archd. of St. Albans*, 142).

⁸⁶ Strype, *Annals*, i, 335; Burnet, *Hist. of Reformation* (ed. Peacock), vi, 480; Morrice MS. (Dr. Williams's Lib.), B, fol. 149.

⁸⁷ For this charge in relation to Hertfordshire see above.

⁸⁸ Morrice MS. (Dr. Williams's Lib.), B, fol. 149.

ECCLESIASTICAL HISTORY

of order held the first place in episcopal inquiries, by 1576 much more attention was paid to the personnel of the clergy.

Difficult as it is to trace the early history of the various incumbents, the official figures make it clear that the standard of learning was not high. In 1576 but nine of the twenty-nine beneficed clergy in the deanery of Braughing were graduates; of the rest three knew no Latin, while eleven had but a slight or middling knowledge of the language. Still more serious was the fact that eighteen had only a middling or slight knowledge of theology.⁸⁹ In the archdeaconry of St. Albans in 1583 the proportion of graduates to non-graduates was five to twelve, twelve of the whole twenty-three being learned in the Latin tongue.⁹⁰ A return made somewhat later for the archdeaconry of Huntingdon shows that thirty of the seventy-seven incumbents in this part of the country were graduates, but gives no particulars of their learning.⁹¹ Such figures were ample justification of the Puritan outcry, and the authorities were bound to seek a remedy.

For one part of the diocese of London very full particulars of the remedial measures have been preserved, and it is evident that the action taken in the archdeaconry of St. Albans must have been common to the rest of the diocese, though of course no such inference is possible in the case of those parishes within the diocese of Lincoln. A visitation was held at Barnet in April 1582, and an order was made 'that every minister of this Jurisdiction being no preacher or mr. of Artes shall monethly geve under his owne hand an exposition of one Chapter of St. Pawle to the Romans begenninge at the first Chapter and so goeing forwarde monethly, unto the next preacher adioyneninge unto him of this Jurisdiction, and so to be delivered quarterly unto the Judge . . . to that end that it may appeare how they have profyted in their studyes.'⁹² The order seems to have been repeated in 1583, but does not appear to have been very effectual, for in April 1585 the bishop required the archdeacon to send him 'a list of all such as shall be notoriously negligent or wilfully disobedient' thereto.⁹³

In July 1586 the bishop went on visitation through the archdeaconry of St. Albans and deanery of Braughing, and some sort of examination of the clergy was made.⁹⁴ In Braughing, though the majority were preachers, eight were ordered to appear for further examination before 'Mr. Sterne, Mr. Bishop, Mr. Bland' and another at Bishop's Stortford on 6 and 7 September following.⁹⁵ For the archdeaconry of St. Albans that place was the centre, and the examination was fixed for 4 October. In August the archdeacon received the necessary instructions from Doctors' Commons together with the list of 'the inferior sort of Ministers not being allowed Preachers, and under the degree of Master of Arts' who were required to attend. The archdeacon was to sit in person on the first day with Roger Williams,

⁸⁹ Lambeth MS. xii, no. 1.

⁹⁰ *Rec. of the Old Archd. of St. Albans*, 35-7. Two of those with no degrees are said to be 'of Oxford' and four 'of Cambridge.'

⁹¹ Lambeth MS. xii, no. 2. A bill introduced into Parliament in 1588 provided that no preacher be admitted to a benefice with cure of souls unless he be a B.D. or a M.A. of five years' standing; that none be admitted to a parsonage with cure of souls of the value of £20-£30 unless an M.A. or preacher 'allowed before,' and that none be admitted to a cure of the value of over 20 marks unless a B.A. or licensed preacher (*Morrice MS.* [Dr. Williams's Lib.], B, fol. 197).

⁹² *Rec. of the Old Archd. of St. Albans*, 21, 38.

⁹³ *Ibid.* 45.

⁹⁴ *Visit. 1586* (Lond. Epis. Reg.).

⁹⁵ *Ibid.*

A HISTORY OF HERTFORDSHIRE

parson of St. Albans, as assessor. The actual work was entrusted to four of the younger clergy⁹⁶: Roger Williams, B.D., parson of St. Albans, William White, M.A., B.D., curate of Northaw, Edward Spendlove, M.A., vicar of Redbourn, and Thomas Holden, M.A., vicar of St. Peter's.⁹⁷ Those summoned for examination were Thomas Longley, vicar of Norton, Thomas Weatherhead, vicar of St. Michael's, Edward Warren, vicar of Hexton, William Mote, vicar of Newnham, Richard Lightfoote, vicar of St. Stephen's, Henry Edmonds, vicar of Watford, William Haylock, vicar of St. Paul's Walden, and John Graunte, the curate of Bushey.⁹⁸ Of these men both Longley and Weatherhead were old. Thomas Weatherhead had received his orders about forty-nine years before from the Suffragan Bishop of Dover⁹⁹; he was a man of some standing among the clergy of the archdeaconry, and in 1580 was one of the five delegated by the Bishop of London to act as ordinary.¹⁰⁰ In 1583 he was returned as 'able to render an account of the faith in the Latin tongue,'¹ and, though no graduate, his examination in 1586 was probably actuated not by doubt of his learning but by suspicion of his views. Like his fellows he had contributed a small sum towards the relief of Geneva in 1582,² but two years later he was presented in the archdeacon's court for railing at his churchwardens during divine service. There was probably a good deal of friction between him and the authorities; he evidently would not brook examination; he was negligent in performing the exercises set him; he did not certify the recusants in his parish and he never preached.³ He died at some time between March and October 1590, aged about eighty.⁴ Another somewhat pathetic figure was that of Edward Longley. He was ordained in or about 1543 by the Bishop of Worcester,⁵ and seems to have favoured the new ideas, for his churchwardens presented in 1583 that though using the Book of Common Prayer he did not wear the ecclesiastical habits there prescribed, though he was 'willing and ready to wear them.'⁶ The living was worth but £5 a year, and the parishioners regarded him as 'sufficient,'⁷ though the examiner of 1586 in great disgust declared that both he and the curates of East Barnet and Sandridge were ignorant of Latin, 'nor able to decline a noun substantive or to discern the parts of speech, and further to be unable to answer unto easy questions in the grounds of faith or religion, or to allege aptly any Scripture for proofs of any Article of Religion.'⁸ So badly, indeed, did he acquit himself that he was suspended, apparently for the inadequate performance of the exercise appointed him.⁹ What afterwards became of him is not known, but his name does not occur later in the records of the archdeaconry.

The other examinees in this archdeaconry, though younger than Longley and Weatherhead, were yet among the older clergy. Butler had been ordained by Jewell at the beginning of the reign¹⁰ and Haylocke in 1560.¹¹ Galling as must have been the instruction, both these men so satisfied the archdeacon as to their attainments that they were allowed as preachers before the visitation of 1588,¹² as was also Richard Lightfoote.¹³ With Edmonds there was

⁹⁶ *Rec. of the Old Archd. of St. Albans*, 52-3.

⁹⁷ *Ibid.* 36, 37, 69, 84; Boase, *Reg. of the Univ. of Oxford*, i, 265.

⁹⁸ *Rec. of the Old Archd. of St. Albans*, 50.

⁹⁹ *Ibid.* 37.

¹ *Ibid.* 37.

² *Ibid.* 23.

³ *Ibid.* 51, 52, 53, 69.

¹⁰⁰ *Ibid.* 12.

⁴ *Ibid.* 74, 77, 69.

⁵ *Ibid.* 36.

⁶ *Ibid.* 33.

⁷ *Ibid.* 33, 36.

⁸ *Ibid.* 53.

⁹ *Ibid.* 52.

¹⁰ *Ibid.* 36.

¹¹ *Ibid.* 86.

¹² *Ibid.* 68, 69.

¹³ *Ibid.* 68.

ECCLESIASTICAL HISTORY

probably no difficulty, as he satisfied his examiner as to his sufficiency¹⁴; Mote and Graunte had not prepared themselves for examination,¹⁵ and were probably suspended as their names do not again appear in the records of the archdeaconry. Warren, who was ordained by Bullinger about 1568, was reported by the examiner to be unable to answer anything in Latin, yet to have some mean knowledge of the principal points of religion, but not sufficient to discharge the office of a minister.¹⁶ He seems to have escaped sequestration, though he had not obtained a preacher's licence by 1588, when, however, he was described as 'an old sickly man.'¹⁷

It was probably in the autumn of 1586 that instructions were issued 'for the better increase of learning in the inferior Ministers, and for more diligent Preaching and Catechizing.'¹⁸ These provided that 'every minister having cure and being under the degrees of Master of Arts and Bachelors of Law and not licensed to be a public Preacher' should by 2 February obtain a Bible, a copy of Bullinger's *Decades* and a note book. Daily notes were to be made on a chapter of Scripture and weekly notes of a sermon of Bullinger, the notes being forwarded each month to a preacher appointed by the ordinary. Such exercises were closely connected with the 'prophesyings' that were so troublesome to the Government. These 'clerical meetings' were first heard of in 1571, and were generally modelled on the form adopted by the clergy of Northampton.¹⁹ The meetings received episcopal approval, but 'divers mynisters, deprived from their livings or inhibited to preach, for not obeying publique orders and discipline of the church of England, have intruded themselves, in sundry places to be speakers in the saide exercises, and being excluded from pulpits, have in the saide exercises usuallie made their invection against the orders, rites and discipline of the church of England, which hath been a cause to move divers to mislike of the saide exercises'²⁰; in the spring of 1574, therefore, Elizabeth ordered the archbishop to suppress them. Parker sent the required notice to his suffragans,²¹ but nothing was done in the matter by Sandys as Bishop of London. Whether or no such meetings were taking part in the Hertfordshire parishes of his diocese is not known,²² but there can be little doubt that they had been adopted in the archdeaconry of Huntingdon, for in October of the same year the Hertfordshire clergy obtained the approval of the Bishop of Lincoln's 'regulations with regard to prophesying.'²³ The clergy were to meet from 9 to 11 a.m. on every alternate Thursday, the members being appointed by the ordinary and bound to accept the constitution laid down by the bishop with whom rested the choice of the moderator. The proceedings were opened with a prayer by the first speaker, who was allowed three-quarters of an hour for his exposition, successive speakers being limited to fifteen minutes; then came a summing up by the moderator and prayers for the queen's majesty, for grace and for 'truth, unities, reverence, discretion

¹⁴ *Rec. of the Old Archd. of St. Albans*, 52.

¹⁵ *Ibid.* 53.

¹⁶ *Ibid.* 52.

¹⁷ *Ibid.* 69.

¹⁸ *Ibid.* 53.

¹⁹ *The Orders and Dealings in the Church of Northampton*; cf. Order of the Prophecy at Norwich (Morrice MS. [Dr. Williams's Lib.], B, fol. 263).

²⁰ Cott. MS. Cleop. F ii, fol. 261; Morrice MS. B, fol. 267-8.

²¹ Frere, *Engl. Church in the Reigns of Eliz. and Jas. I.*, 186-7.

²² No documents of this date exist among the records of the archd. of St. Albans.

²³ Lansd. MS. 19, fol. 47-9. Bp. Cooper seems to have encouraged the exercises (*Linc. Epis. Rec.—Bp. Cooper*—[Linc. Rec. Soc.], p. xi).

A HISTORY OF HERTFORDSHIRE

and diligence in our ministerie.' The form of prayer was prescribed, and the manner of the discourse ordered with the warning that 'all the speakers ought carefully to keepe them to the text, abstainynge from hepyng uppe of manie testimonies, allegations of prophane histories, exhortations, applications, common places and divisions not aptly grounded upon the Text; not falling into controversies of our private tyme or state, nether glancyng closely or openly at anie persons publique or private, much lesse confutyng one a nother.' At the close of the meeting the first speaker went out and those present delivered their criticisms to the moderator. 'This done, the first speaker must be contented to be admonished by the moderator and the rest of the brethren of such things as shall seem to the company worthy of admonition.'²⁴ The moderators appointed in 1574 were Horne, vicar of Hemel Hempstead, Hammon, rector of Letchworth, John Potkins, rector of Lilley, and Thomas Mountford, vicar of Tring. Little more is known of the Hertfordshire prophesyings. In spite of Grindal's defence of the exercise as 'a thing profitable to the Church'²⁵ it was held in distrust by the Government and in 1576, finding that the archbishop would not quash the meetings, the queen sent letters to the bishops individually ordering their suppression.²⁶ The 'godly exercises' were, however, restored by Convocation in March 1585, and probably played an important part in the furtherance of Puritan methods and ideals.

It will be noticed how closely the order of these 'prophesyings' followed the course still adopted for training the preacher. And this, indeed, was the main object of the work, for the attention of every party in the State was at this time concentrated on preaching. The growth of education and of the cheap press has lessened both the popularity of sermons and the influence of preachers, but in the 16th century when politics and religion stood in such close relationship, when the press was censored and expensive and the ability to read not universal, the spoken word was a force which cannot be overestimated. The power of the pulpit in the formation of popular opinion was fully recognized by Elizabeth and her advisers, and in December 1558²⁷ the queen issued a proclamation forbidding 'any person, whether papist or gospeller, to preach to the people.'²⁸ In 1559, however, the Injunctions of 1547 were again promulgated with certain alterations and additions, one of which provided that the clergy 'shall preach in their own persons, once in every quarter of the year at least, one sermon, being licensed especially thereunto, as is specified hereafter; or else shall read some homily prescribed to be used by the queen's authority every Sunday at the least, unless some other preacher sufficiently licensed, as hereafter, chance to come to the parish for the same purpose of preaching.'²⁹ Licences were to be issued by the queen, the archbishops, the bishop of the diocese or the royal visitors.³⁰ From the return made for the deanery of Braughing³¹ in 1561 no indication of the number of preaching ministers there can be obtained, and in 1565 all existing licences were revoked.³² Doubtless the Crown would

²⁴ Lansd. MS. 19, fol. 47-9.

²⁵ Morrice MS. (Dr. Williams's Lib.), B, fol. 261.

²⁶ Frere, op. cit. 193. For the letter see Cott. MS. Cleop. F ii, fol. 287.

²⁷ Strype, *Annals*, i (1), 59.

²⁸ *Zürich Letters*, 1558-79 (Parker Soc.), 7.

²⁹ Gee, op. cit. 48.

³⁰ *Ibid.* 49.

³¹ Visit. of Grindal, 1561 (Lond. Epis. Reg.).

³² Frere, op. cit. 127.

ECCLESIASTICAL HISTORY

have suppressed preaching entirely but for the force of public opinion.³³ In December 1576 Elizabeth appears to have protested to the archbishop, who replied that he had given charge to the bishops to exercise care in the issuing of licences, adding that 'we admit no man to the office of preaching that either professeth papistrie or puritanisme; generallie graduates of the universities are onelie admitted to be preachers, unlesse it be some few which have excellent giftes of knowledge in the scripture ioined with good utterance and godlie perswasion.'³⁴ With these rules in mind special interest attaches to the list of preachers furnished by the visitation lists of the same year for the deanery of Braughing.³⁵ The only royal licence was that held by Alexander Nowell, rector of Much Hadham and Dean of St. Paul's. Of the eight other graduates³⁶ two only had licence to preach, these being Robert Key, B.A., vicar of Ware, and Christopher Tatham, M.A., rector of Thorley. Thomas Tunstall, vicar of Broxbourne, was also licensed; he is described as a 'grave' man knowing no Latin and but slightly versed in theology. The only other preacher was the vicar of Standon, Hugh Bowman, who joined skill in theology to a slight knowledge of Latin.³⁷ The other parishes would apparently have to be content with the Homilies, which the archbishop maintained were not so efficacious.³⁸

Such caution in the issuing of licences was bound to lead to unauthorized preaching, and in 1582 one of the visitation articles promulgated in the archdeaconry of St. Albans inquired after preachers without cure of souls, while another dealt with the preaching of political sermons; in every case non-committal answers were obtained.³⁹ By this time, however, the licensing system seems to have been somewhat relaxed, for when the ignorant clergy were enjoined to take their exercises to a preacher, 'because they shoulde not pretende ignorance who be the preachers the . . . Judge did decre that they should repayre . . . eyther unto those which are Bachelers of Divinitye, masters of Artes or preachers licensed.'⁴⁰ In March 1583-4 the Privy Council issued Articles of inquiry the answers to which show an improvement in this archdeaconry. There were no regular preachers at Sandridge, Codicote, Ridge, St. Paul's Walden, and, apparently, Newnham, but at Codicote due provision was made for quarterly sermons.⁴¹ Of the remaining parishes in this county seven replied that they had a minister who was their vicar, a form probably implying that he was a preacher, while the incumbents of Redbourn, Sarratt, St. Peter's, Abbot's Langley, Northaw, Chipping Barnet and Rickmansworth are definitely spoken of as preachers.⁴² At Watford, where the vicar, Henry Edmonds,⁴³ was a man of no learning, one John Chapman, M.A., acted as preacher,⁴⁴ probably strengthening the foundations of that Puritanism for which the town was already distinguished.

³³ cf. the queen's letter to the bishops 7 May 1577 (Cott. MS. Cleop. F ii, fol. 287). Bishop Cooper in 1573-4 thought 'that the cheefe parte and ffunction of a prieste or mynister consystith in preacheinge goddes woord' (*Linc. Epis. Rec.—Bp. Cooper—*[Linc. Rec. Soc.], 146).

³⁴ Morrice MS. (Dr. Williams's Lib.), B, fol. 260.

³⁵ Lambeth MS. xii, no. 1.

³⁶ None held degrees in divinity which would *ipso facto* have given them the right to preach. ³⁷ *Ibid.*

³⁸ Morrice MS. loc. cit. In 1576 Ralph Tomlyn was licensed by Bishop Cooper to preach in the parish church of Aspenden (*Linc. Epis. Rec.—Bp. Cooper—*[Linc. Rec. Soc.], 141); a similar licence was granted in the following year to Samuel Otes for the deanery of Baldock (*ibid.* 142).

³⁹ *Rec. of the Old Archd. of St. Albans*, 17-20.

⁴⁰ *Ibid.* 21. cf. the articles issued by Archbishop Whitgift in October 1583 (Gee and Hardy, *Doc. illustrative of English Church Hist.* 481-4).

⁴¹ *Rec. of the Old Archd. of St. Albans*, 26-35.

⁴² *Ibid.*

⁴³ He had started life as a chorister of St. Paul's (*ibid.* 36).

⁴⁴ *Ibid.* 29-30.

A HISTORY OF HERTFORDSHIRE

With this list may be compared one made in July 1586⁴⁶ which gives as preachers the incumbents of Elstree, St. Peter's, Redbourn, Ridge and Shephall, while those of St. Paul's Walden, St. Michael's and Watford are marked as non-preachers, this probably meaning that they did not even attempt a quarterly sermon. The deanery of Braughing also showed a better state of things, where all were preachers but Thomas Clerk, vicar of Barkway, Simon Williams, vicar of Cheshunt, Francis Rydall, rector of Reed, Evans Offludd, vicar of Stanstead, and Nicholas Compton, vicar of Sawbridgeworth,⁴⁶ while Tristram Moore, rector of Wymondley, was a preacher but not admitted by the bishop.⁴⁷

The review of the county may be completed by a reference to the return for the archdeaconry of Huntingdon made at about this date.⁴⁸ Here a different policy seems to have been carried out. While thirteen graduates were licensed, ten men of equal standing had no licence to preach, and this fact suggests that a certain discrimination was used in this archdeaconry; all are said to be conformable, but the weight of the return on the point is modified by this remark being also appended to the name of Richard Chambers, vicar of Hitchin, who in another part of the document is especially mentioned as a 'recusant.'⁴⁹ Besides these ten, fifty-six of the clergy were not licensed, while of four more no details are given.

Further instructions as to preaching were issued by the Bishop of London in 1588, when ministers, if preachers, were 'urged to make some exhortation every week' at the time of prayer,⁵⁰ while 'strait charge' was to be given to the ministers 'that they have not above one Sermon on any one day.'⁵¹ The synod of December 1586 had thought fit that certain articles should 'be put into execution by the Bishops, though not a judicial act by authority of Convocation.'⁵² These articles provided for the attendance at the exercises of such graduates as refused to preach after admonition by the ordinary, for the preaching of twelve sermons yearly at the least by every licensed preacher and for itinerant preachers, 'so that there may be in every parish one Sermon at least every Quarter.'⁵³ These provisions seem to have formed the basis of the action taken by the Archdeacon of London in January 1586-7,⁵⁴ but nothing was done in the archdeaconry of St. Albans until the following winter. In the return then made it was reported that under Mr. Thomas Wetherhead was a Mr. William Dyke, who 'preacheth at St. Michael's but hath no cure, he is of no degree, he is only a deacon, and licensed . . . as he saith.'⁵⁵ From the first Dyke had been suspect,⁵⁶ but he had powerful friends and was maintained at St. Michael's by the widow of Sir Nicholas Bacon, who had prevailed on Cecil to recommend him for a licence to the bishop.⁵⁷ As the parishioners ingeniously put it in

⁴⁵ Visit. 1586 (Lond. Epis. Reg.).

⁴⁶ Against the name of Nicholas Warde, the preacher here, is written 'abiiit.'

⁴⁷ Visit. 1586 (Lond. Epis. Reg.).

⁴⁸ Lambeth MS. xii, no. 2.

⁴⁹ Ibid.

⁵⁰ *Rec. of the Old Archd. of St. Albans*, 63.

⁵¹ Ibid.

⁵² Ibid. 66.

⁵³ Ibid. 67.

⁵⁴ Strype, *Life of Aylmer* (ed. 1821), 83-4.

⁵⁵ *Rec. of the Old Archd. of St. Albans*, 69.

⁵⁶ As preacher of Coggeshall, Essex, he had been suspended and imprisoned for non-conformity (Urwick, *Nonconformity in Herts.* 106).

⁵⁷ Strype, *Life of Aylmer* (ed. 1821), 104, 202. For Dame Ann Bacon see *Dict. Nat. Biog.* Many of her letters are printed by Spedding, *The Letters and Life of Francis Bacon*, i. She was a convinced Puritan and regarded Whitgift as 'the destruction of our church' (ibid. 112). Though a woman of violent temper she acted with great kindness towards those of the Hertfordshire clergy who met with her approval (ibid. 312).

ECCLESIASTICAL HISTORY

1589, 'they had lived without any ordinary preaching until within four or five years. By which want they knew not, as they ought, what did belong to God, what to their Prince, their rulers, their neighbours, their families, to bring them up in that obedience and subjection as was meet.'⁶⁸ Bishop Aylmer's version of the matter was that Dyke was 'troubling his auditory with new opinions and notions, thwarting the established religion,'⁶⁹ and that he had refused to take priest's orders though a deacon of long standing.⁶⁹ On the petition of the parishioners Burghley remonstrated with Aylmer, pointing out that the people were now untaught, having 'for a Curate a very insufficient, aged, doting man,' and that Dyke, who had probably erred through excessive earnestness, 'would hereafter be more advised and in a temperate sort carry himself.'⁶¹ The bishop seems to have complied with this request from so powerful a quarter, for Dyke was still preaching at St. Michael's in April 1590.⁶²

How the duty of preaching was discharged by the more able and zealous of the clergy may be gathered from the conduct of Andrew Willet, who preached 'in his church of Barley, for a long time, thrice every week.'⁶³ 'And although he had been chaplain to that noble young Prince Henry, and both during that time, and sometimes since, had preached at court, and knew how to tune his tongue to the most elegant ears; yet amongst his own people he taught . . . after a most familiar way, affecting a plain phrase and humble style, applying himself to the capacity of his hearers; reputed that sermon best adorned, that was least set out with human learning or eloquence, or perplexed with curious questions that help not to heavenwards.'⁶⁴

By the time of the accession of Whitgift to the primacy in 1583 Puritanism had gained a definite position and the controversy had shifted from mere matters of order to the constitution of the Church. None appreciated better than the archbishop how serious was the position nor how greatly the danger was aggravated by the ignorance of the authorities as to its extent. His first act, therefore, after his election was confirmed in September, was to issue articles which were sent to the bishops under cover of a letter dated 19 October. The returns for the archdeaconry of St. Albans have been preserved, and it seems possible that a summary list of clergy within the archdeaconry of Huntingdon may also be referred to this date, but no return for the archdeaconry of Middlesex is available, and the review of the county must therefore be incomplete. The Bishop of London forwarded Whitgift's letter to the Archdeacon of St. Albans on 31 October, and followed this on 31 December with a letter from the archbishop dated 12 December and inclosing further articles of inquiry promulgated by the Privy Council.⁶⁵ Nothing, however, was done here until March. The first three of the archbishop's articles dealt with attendance at divine service

⁶⁸ Lansd. MS. 61, fol. 70-1; printed by Strype, *op. cit.* 301-2.

⁶⁹ Strype, *op. cit.* 104. For the charges against Dyke and his defence see Lansd. MS. 61, fol. 72-4.

⁶⁰ Strype, *op. cit.* 203.

⁶¹ *Ibid.* 203-4.

⁶² *Rec. of the Old Archd. of St. Albans*, 75. In 1591 he was presented to the vicarage of Hemel Hempstead in the diocese of Lincoln (Urwick, *Nonconformity in Herts.* 115, 427).

⁶³ Fuller, *Abel Redivivus*, ii, 319.

⁶⁴ *Ibid.* For the truth of these remarks see Willet, *Ecclesia Triumphans*, being sermons preached in Barley Church.

⁶⁵ *Rec. of the Old Archd. of St. Albans*, 35.

A HISTORY OF HERTFORDSHIRE

and Roman Catholic recusancy, while the tenth related to the translation of the Bible used in the church. The intermediate questions, however, were concerned with the important matters of the use of the Prayer Book, conformity to the established order and the prescribed habit, the qualifications of the minister and the occurrence of private preaching.⁶⁶ Though most of the replies were in the affirmative they must have been highly unsatisfactory to Whitgift, for they revealed the fact that the 'conformity' of the layman in Hertfordshire was by no means what the authorities understood by the word. This was especially noticeable in regard to the habit of the minister, for while the incumbents of Redbourn, Codicote, Hexton, Norton, Watford, St. Peter's, St. Michael's, St. Stephen's, Rickmansworth and Barnet were all returned as 'conformable' they all failed to wear the prescribed vestments, though several declared themselves 'willing and ready' to do so. At Redbourn the vicar, Edward Spendlove, though he wore the surplice, said that 'otherwise' he would 'reform his attire according to the Queen's Majesty's Injunctions as soon as he shall be able to provide the same,'⁶⁷ but it is uncertain whether this referred to the outdoor dress of the clergy⁶⁸ or to 'a Coape an Albe and a tunicle,' to which the Puritans complained that they were bound by the Prayer Book.⁶⁹ The most serious state of affairs revealed was at Rickmansworth, where the vicar was Andrew Arnold, a graduate who had been collated to the living in 1581.⁷⁰ From the grudging answer to the sixth article of the Privy Council's inquiries that 'our Minister which now serveth the cure is a sufficient man and of good conversation for aught we know or have heard,' it would seem that he was somewhat unpopular with his parishioners, and this may have influenced the character of the other replies. According to the churchwardens and 'sworn men' Arnold sometimes omitted to read the epistle and gospel on Sundays, and did not show conformity, for, they continued, 'during the time of his abode with us he hath not worn nor used the surplice in saying of divine service and administration of the sacraments.'⁷¹ That the archbishop took a serious view of his case seems probable, for though no direct evidence of deprivation has been found his successor was instituted in the following year, no reason being given in the register for the change.⁷² The return by the sworn men of Sandridge that the incumbent had 'had business and a sufficient man doth supply his charge and that we think he will be conformable'⁷³ supplies a reason for the anxiety of the queen and her counsellors for the abolition of pluralities. Curiously enough no list of subscriptions for this archdeaconry has been found, but the list for that of Huntingdon shows that in its parishes within this county only three 'recusants' were found—Richard Chambers, vicar of Hitchin, John Potkins, rector of Lilley, and Thomas Wilcocks, curate of the chapel of Bovingdon.⁷⁴

⁶⁶ S. P. Dom. Eliz. cxliii, 31; Strype, *Life of Whitgift*, i, 228, 232.

⁶⁷ Strype, *op. cit.* 27.

⁶⁸ In 1595 the Bishop of London wrote to the Archdeacon of St. Albans commanding that as some ministers have attended visitation 'attired very undecently, as in coloured cloaks and other unseemly fashions . . . they are to come either in gowns or in comely black cloaks' (*Rec. of the Old Archd. of St. Albans*, 93).

⁶⁹ Morrice MS. (Dr. Williams's Lib.), B, fol. 327.

⁷⁰ Clutterbuck, *op. cit.* i (1), 201.

⁷¹ *Rec. of the Old Archd. of St. Albans*, 31.

⁷² Clutterbuck, *loc. cit.*

⁷³ *Rec. of the Old Archd. of St. Albans*, 26. The curate was probably William Peggrym. About Michaelmas 1584 he was 'detected' in the archdeacon's court for brawling in the churchyard and his vicar for brawling in the church. Finally he was 'inhibited unless he would procure a licence and departed immediately' (*ibid.* 51).

⁷⁴ Lambeth MS. xii, no. 2. There were two 'recusants' in Huntingdonshire.

ECCLESIASTICAL HISTORY

Considering the number of benefices and the comparatively easy reach of London and its turmoils the number of known deprivations during this period is remarkably small. But evidence in this respect is almost entirely confined to parishes within the diocese of London owing to the serious gap in the Lincoln registers. Though few details have been preserved there seems little doubt that Nathaniel Baxter, vicar of Redbourn, was deprived in the spring of 1579–80 when the churchwardens presented that it had been ‘appoynted by my lorde of Canterberyes grace that Mr. Baxter shall departe and Mr. Spendlove to be in full possession of [the] vicarage in consideration whereof he must paye unto Mr. Baxter a certen sume of monye.’⁷⁶ Edward Spendlove apparently met with the approval of the authorities; he was an examiner of unlearned ministers, a preacher and a scholar. For a time all went well, but in the summer of 1588 he wrote to the archdeacon that ‘whereas by reason of a certain crime objected against me, I was convented before the Justices at the last Sessions, and by them adjudged either to sustain open punishment or else to resign my benefice . . . I chose rather to forego my benefice, for my profession’s sake, than to incur that open infamy.’⁷⁶ Humphrey Wildblood was instituted to the vacant living in November 1589, apparently by the influence of Francis Bacon.⁷⁷ Though little is known of his career, his views may be judged from the fact that in May 1590 Lady Bacon wrote to her son that she thanked God ‘for the comfortable company of Mr. Wyborne and Mr. Wylblud.’^{77a} He seems from the first to have been hostile to the established order of things, and in 1590 he, White of Northaw and Warren of Hexton were the only clergy in the archdeaconry who ignored the summons to an inspection of the military equipment charged on the clergy.⁷⁸ He was deprived before October 1592,⁷⁹ probably for Puritanism, for immediately afterwards he was acting as preacher at St. Michael’s, though refusing to appear before the archdeacon to show any letters of orders or any other instruments.⁸⁰ His successor at Redbourn was Rodolph Bradley⁸¹; he, while performing the military service expected from him, refused to produce letters of orders or other documents for the satisfaction of the officials in January 1592–3,⁸² and he may have maintained this recalcitrant attitude, for in June 1602 Richard Gardton was instituted on Bradley’s cession of the vicarage.⁸³

A better index of the progress of Puritanism than is afforded by these deprivations can be found in the character of the services and ministry of the day. In 1566 ‘moderate men’ complained that ‘in the public prayers, although there is nothing impure, there is, however, a kind of popish superstition,’⁸⁴ but by 1583 this had given place to a thorough hatred of the Book of Common Prayer, not only for its papistry, but for the length of its

⁷⁶ *Rec. of the Old Archd. of St. Albans*, 11.

⁷⁶ *Ibid.* 61. No entry regarding this case is to be found among the Sessions Records.

⁷⁷ Clutterbuck, *op. cit.* i, 182; Spedding, *Letters and Life of Francis Bacon*, i, 115.

^{77a} Spedding, *op. cit.* 114.

⁷⁸ *Rec. of the Old Archd. of St. Albans*, 80–1.

⁷⁹ Clutterbuck, *loc. cit.*

⁸⁰ *Rec. of the Old Archd. of St. Albans*, 88.

⁸¹ Clutterbuck, *loc. cit.*

⁸² *Rec. of the Old Archd. of St. Albans*, 88.

⁸³ Clutterbuck, *loc. cit.* It must have been Bradley that Lady Bacon maintained to be ‘a Papist or some sorcerer or conjurer or some vild name or other’ (Spedding, *op. cit.* i, 312).

⁸⁴ *Zürich Letters*, 1558–79 (Parker Soc.), 163.

A HISTORY OF HERTFORDSHIRE

services, which hindered preaching.⁸⁵ Whitgift's articles had been especially directed against those who preached but refused to use the Prayer Book, and while under its ordinance daily prayer was recognized as obligatory it so rapidly fell out of use that in 1588 the archbishop issued special directions to his diocesans⁸⁶ for prayers to be held in every parish church at least thrice in the week.⁸⁷ The order had again to be issued in 1589-90.⁸⁸

With the promulgation of the canons of 1604 a new phase in the struggle began, though it is noticeable that the resisters were not the younger men but the protagonists of Elizabeth's reign. John Burgess, who led the protest, was beneficed in the diocese of Lincoln, and among the thirty Lincoln clergy who followed him to the interview with their bishops at Buckden were three from Hertfordshire parishes. These were Nicholas Chambers, Nevill Drant and Timothy Fisher.⁸⁹ All were probably in a like case with Burgess, men who had hitherto subscribed to the Prayer Book as an expression of the intention of the church, though they could not approve its details. Nicholas Chambers was perhaps more advanced in his views than the others. He it was who with Wilcox and Potkins had refused subscription at an earlier date,⁹⁰ though he must have ultimately satisfied his conscience. The protestants got little satisfaction out of the bishop, and on 1 December they presented their views to James I, praying that if the new subscriptions were retained the threatened deprivations might be at least delayed. They drew a pathetic picture of their trouble, their journeyings to conferences with the ordinary, with each other and the lawyers, and their desperate case should they be deprived. James heard them out and suggested a conference at Huntingdon. The ministers agreed to accept this, but put forward as conditions that the disputants on the side of the established order were to be the bishop himself and Dr. Montaigne, that the point in question should alone be discussed, that the conferences should be open to all and that reporters should be in attendance. In the eyes of the government the proposal would have been a mere advertisement of the impotence of the hierarchy and the ideas of the Puritans. It was accordingly rejected. What actually took place it is difficult to determine, but in November a petition from the inhabitants of Royston⁹¹ and the neighbourhood implies that deprivation was generally threatened. Beside the language of this petition may be placed the words of Bancroft to the Bishops of London in a letter dated 12 March 1604-5 and probably one of a series addressed to all his suffragans. The letter relates chiefly to Roman Catholic recusants, but opens with a desire that Vaughan would not desist from depriving two or three factious ministers till he had purged his diocese of them.⁹² Nothing, however, was done until 1609, when Richard Scott, rector of Bushey, was deprived.⁹³ Scott had been educated at New College, Oxford, but had taken

⁸⁵ For a schedule of objections see Morrice MS. (Dr. Williams' Lib.), B, fol. 327. The Puritans asked 'whether it be not an unseemlie gesture, y^t y^e mynister in saying the service, should go poste up and downe from place to place, as by the booke is appointed, as to the chauncell for sayinge the service, and singing the communion, to the bod'e of y^e chirch for the Letanie and mariage, to the church dore for baptisme and to the church stile for buryall And to y^e bellfrey on working dayes to toull the bell himselfe.'

⁸⁶ *Rec. of the Old Archd. of St. Albans*, 75.

⁸⁷ *Ibid.*

⁸⁸ *Ibid.* 73-4.

⁸⁹ Add. MS. 8978, fol. 116 d.

⁹⁰ Lambeth MS. xii, no. 2.

⁹¹ Harl. MS. 677, fol. 44. This must have been the petition presented to James as he was hunting at Royston. 'The King took in ill part this disorderly Proceeding, commanding them presently to depart' (*Winwood, Mem.* ii, 36).

⁹² *Rec. of the Old Archd. of St. Albans*, 124.

⁹³ *Newcourt, Report.* 816.

ECCLESIASTICAL HISTORY

no degree. He seems to have had some influence, and was patronized by the Lord High Admiral and the Earl of Northampton to whom he was chaplain in 1603.⁹⁴ In 1584 he was presented to this living by Henry Hickman; at this time, possibly, his views were not fully formed, for he was 'no preacher' and did not obtain licence to preach until eight years later.⁹⁵ In 1603 a return was made that at Bushey 'divine service was twice duly said and the word likewise painfully and profitably preached twice every Sabbath day'⁹⁶; yet this does not necessarily imply that the Prayer Book was used, and the Prayer Book could be manipulated to meet the views of men whose conscience could not endorse the new canons. The second deprivation was that of John Spenser, vicar of Hoddesdon,⁹⁷ whose successor was collated to the living in March 1609-10. Spenser had held the living since 1592, and so may be presumed to have had considerable influence in his neighbourhood.⁹⁸ Three resignations took effect in the years 1606-9; all were of livings in the archdeaconry of St. Albans,⁹⁹ but only one can be assigned with probability to the cause of conscience. Erasmus Cook, B.A., was presented to the vicarage of St. Michael's by Dame Ann Bacon in 1591, and doubtless belonged to the advanced Puritan school of thought of which she was a patron. The records of the archdeaconry represent him as a man of good learning, who catechized diligently, who preached twice on Sundays and generally once on holidays,¹⁰⁰ this last a fact of some interest as indicating that he followed the Prayer Book in the observance of such feasts.

With the first decade of the 17th century the ecclesiastical and academic aspect of Puritanism passed away and gave place to a movement which was essentially political. The old forms were indeed retained and their language popularized, but the informing motive had changed. A learned and preaching ministry and external pressure had spread seriousness from the universities to the middle classes and the middle classes had applied its formulae to politics. But while Puritan ideas were thus making their way in the country at large a reaction was setting in at Oxford and Cambridge, and the study of the Fathers, which in the past generation had led men to long for the re-establishment of the primitive order, was now reviving the conception of the historical church.¹

The dislike to episcopacy was perhaps the most marked characteristic of public opinion, and with this went a growing distrust of sacramental doctrines. In Elizabeth's reign complaint had been made of the general superstition that sent children in hundreds to be confirmed; the practice was discouraged by the clergy, and by 1614 the archdeacon reported to the Bishop of Lincoln that he could not 'perceive any Forwardness in any of the Ministers to have the Children of their Parishes confirmed,' and in the opinion of the chancellor of the diocese a special charge for that purpose was necessary.²

Neglect of the ordinances of the Church was coupled with direct hostility to its rulers and hence, in the opinion of the time, to the civil

⁹⁴ Newcourt, *Repert.* 87, 116.

⁹⁵ *Ibid.* 69, 87.

⁹⁶ *Ibid.* 113.

⁹⁷ *Ibid.* 813.

⁹⁸ One other vacancy may possibly be due to deprivation. Thomas Talbot, M.A., vicar of Hexton, was succeeded in July 1609 by Oliver Burdsett, but no reason for the change is assigned (*ibid.*).

⁹⁹ i.e. Sarratt, St. Michael's and Hexton.

¹⁰⁰ *Rec. of the Old Archd. of St. Albans*, 85, 114.

¹ cf. Pocklington, *Allare Christianum and Sunday no Sabbath.*

² Add. MS. 5853, fol. 166b.

A HISTORY OF HERTFORDSHIRE

government. In March 1621-2 the archbishop sent a general letter to his suffragans in which he stated that the king had been 'informed that divers Preachers have cast out words in the pulpit, as if there were some danger that Religion should be changed amongst us, which cannot be esteemed less than a seditious speech, and very scandalous unto the King.'³ The letter was forwarded to the provinces, but no action seems to have been taken, and five months later the archbishop addressed a further letter in which complaint was made that 'divers young students, by reading of late writers and ungrounded divines,' did 'broach many times unprofitable, unsound, seditious and dangerous doctrines, to the scandal of this Church and disquieting of the State and present government.'⁴ The letter was accompanied by royal directions which restricted Sunday afternoon sermons to points in the Catechism, the Creed, the Ten Commandments, and the Lord's Prayer, and forbade political sermons and the preaching to a 'popular auditory' of 'the deep points of Predestination, Election, Reprobation, or of the Universality, Efficacy, Resistibility or Irresistibility of God's Grace.'⁵ These rules were especially framed with a view to the control of the Lecturers, 'a new body severed from the ancient Clergy of England, as being neither Parsons, Vicars, nor Curates.'⁶ The establishing of Lectureships was a recent phase of the Puritan propaganda, and one which was obviously open to much abuse. The 'Directions' endeavoured to bring the lecturers under episcopal supervision by insisting that they should be licensed 'in the Court of Faculties only, upon recommendation of the party from the Bishop of the diocese under his hand and seal, with a fiat from the Lord Archbishop of Canterbury, and a confirmation under the Great Seal of England.'⁷ It is difficult to say to what extent the practice had spread in Hertfordshire at this date, but the visitation of the archdeaconries of Middlesex and St. Albans in 1628⁸ gives the names of preachers other than incumbents or curates at Stortford, Standon, Ware, St. Albans and Watford. Ware and St. Albans had both two of these additional clergy, who in each case are characterized as schismatics. At Widford and Wymondley appeared clergy of whom some suspicion was entertained as to their being in fact lecturers, though put forward as curates, but no evidence has been found to show whether further action was taken in the matter. Laud as Bishop of London was fully alive to the importance of keeping control over the lecturers, but he could not make his subordinates appreciate his anxiety. There seems to have been considerable neglect in the archdeaconry of St. Albans. In September 1630 the archdeacon had an interview with Laud, who was seriously annoyed at the failure to certify the names of the lecturers and their conformity to the royal directions. The result was an urgent letter to the commissary that forms a curious comment on the administration of affairs under Laud. 'What more particularly the Official or you are to certify,' wrote the archdeacon, 'I doubt not but you shall find in my Lord of London's Letter . . . concerning that business. I make no question but he was careful enough in the keeping of the Letter, so that I hope you shall soon find it among his papers. Let me entreat

³ *Rec. of the Old Archd. of St. Albans*, 147.

⁷ *Ibid.* 149-50.

⁸ *Visit. 1628* (Lond. Epis. Reg.).

⁴ *Ibid.*

⁵ *Ibid.* 149.

⁶ *Ibid.*

ECCLESIASTICAL HISTORY

your care that we hear no more of it, for the displeasure upon further neglect will fall heavy upon whomsoever.’⁹

As the visitation of 1628¹⁰ was the first held by Laud as Bishop of London it is particularly regrettable that no returns exist beyond a bare list of names. Against these, however, occasional notes have been made, and the degrees of each man are noted as well as cases of absence from reasonable cause. The incumbents of Hunsdon, Great and Little Hormead, Stocking Pelham and Bishop’s Stortford are noted as schismatics, together with the curates of Stortford and Standon and also Thomas Owen,¹¹ one of the two curates of Ware under Charles Chauncey. It is remarkable that with a single exception the beneficed clergy thus singled out held their livings until their death.¹² In the case of Nathaniel Morris, M.A., rector of Stocking Pelham, no entry in the episcopal registers occurs for his immediate successor, and it thus appears probable that Morris held the living until the Commonwealth period.¹³ If so he must have become more conformable, though special inquiries were directed to be made in the metropolitan visitation of 1636–7 concerning the incumbents of Stocking Pelham, Furneux Pelham and Albury.¹⁴

The enforcing of ecclesiastical order both on clergy and laity rested with the courts of the bishop and archdeacon. Various efforts had been made towards reform, but the officials stood in the way,¹⁵ and the courts gradually lost their effective power, the tendency being either to bring to bear personal influence or to appeal to the Court of High Commission. The position of the Consistory Courts is exemplified by the case of certain parishioners of Walkern who petitioned Archbishop Laud in 1637. Their rector, John Gorsuch, D.D., had some trouble at Christmas 1636 over the question of communicating at the altar rails, and on the eve of Good Friday Thomas Humberstone and his wife went to Dr. Gorsuch ‘and acquainted him with their purpose of receiving the Holy Communion on the next day. They paid him their accustomed offerings on Good Friday, and drew all of them out of the church into the body of the chancel, and there kneeling desired to be partakers thereof, but were refused by the Doctor and his curate, unless they would come up to the rail.’ They then applied to Holdsworth, archdeacon of Huntingdon, who saw Gorsuch on the subject, and wrote ‘a persuasive letter to them to reform their carriage.’ Thereupon they addressed a petition to Williams as Bishop of Lincoln, begging his intervention. The bishop, whose views on the position of the altar were widely known through his book, *The Holy Table: Name and Thing*, at once took the part of the parishioners, saying of Gorsuch that it was ‘a bold part in him and more in his curate to deny the communion upon such weak foundations,’ and requiring him ‘to warn a communion and to administer the same to as many of those parties as shall present themselves, in any part of the church,

⁹ *Rec. of the Old Archd. of St. Albans*, 155.

¹⁰ Visit. 1628 (Lond. Epis. Reg.).

¹¹ Thomas Owen may have moved into the diocese of Lincoln, for one of that name was curate of King’s Walden in 1630 (Urwick, *op. cit.* 667), of Datchworth in 1635–40 (*ibid.* 574). He was given the living of Bramfield in 1643 (*Commons’ Journ.* iii, 134), was ejected in 1660, complied, and was presented to Sandridge in 1661 (Urwick, *op. cit.* 332). Thomas Leigh, curate of Stortford, apparently remained there (*ibid.* 124; cf. 696, 699 n.).

¹² Newcourt, *Reperz.* i, 836, 838, 840, 896.

¹³ *Ibid.* 857.

¹⁴ S. P. Dom. Chas. I, cccxxix, 53; cccli, 100. By order of Laud a special charge was sent to the Dean and Chapter of St. Paul’s that they should take better care of their peculiars (*ibid.*).

¹⁵ cf. *Rec. of the Old Archd. of St. Albans*, 119–21.

A HISTORY OF HERTFORDSHIRE

kneeling, under pain of suspension in him and deposition in his curate.' Gorsuch then appealed to Laud, alleging that he could obtain no order against Humberstone in the courts of the Bishop of Lincoln as that prelate would not suffer them to be presented and remitted all punishment in such cases; he prayed that the case might be referred to the court of High Commission. Humberstone and his wife also petitioned the archbishop and stated their readiness 'to receive either at the rails or in the chancel.' Gorsuch had thus won his point, and Laud in October issued directions to Sir John Lamb, commissary to the Bishop of Lincoln, that any process against Humberstone should be quashed, and that Gorsuch should 'cease all further suit and do what shall be fitting in a peaceable and Christian-like way.'¹⁶ A further case of a slightly simpler character occurred at Welwyn, where sixteen men complained to the archdeacon of the refusal of their parson to communicate them otherwise than at the altar rails. In this instance there appears to have been no appeal to the bishop or his courts, but Holdsworth and the men went to Laud, who, however, refused to interfere, leaving the matter to be settled by the archdeacon.¹⁷

Contempt of the Consistory Courts seems to have been general, and in 1638 a correspondent wrote to Sir John Lamb that 'those refractory women of King's Walden, who were enjoined to penance at your last court at Hatfield . . . not only please themselves in contempt thereof,'¹⁸ but threatened to appeal to the High Commission. Such cases demonstrate the truth of the remark of Hacket that at this time the Consistory Courts had become 'in a manner despicable.'¹⁹

They had indeed been superseded by the court of High Commission which was constituted under the Act of Uniformity. Its absorption of the authority of the ecclesiastical courts may be illustrated by a few typical cases from this county for 1634. The old moral jurisdiction of the episcopal courts is seen in the long suit for alimony brought by his wife against Sir William Cade of King's Langley.²⁰ In this year the most distinctively ecclesiastical causes brought before the court from this county were those of John Downes the curate and the churchwardens of Shenley,²¹ of Robert Clarke, vicar of Sarratt,²² and of Charles Chauncey, vicar of Ware, and Humphrey Packer, yeoman of the same town.²³ As an illustration of the action of the court as well as of the moderate Puritan thought of the time it will be well to examine the case of Chauncey in detail.

Charles Chauncey was the son of George Chauncey, esq., of Ardeley Bury and New Place, Gilston; he was born in 1592 and was related to several well-known families in the county. He was educated at Westminster and Trinity College, Cambridge, and proceeded M.A. in 1617.²⁴ His college gave him the living of Ware in February 1627-8,²⁵ but he resigned this in 1633 after he became vicar of Marston St. Lawrence (co. Northants). His immediate successor at Ware had been John Mountfort, rector of Anstey and prebendary of Sneating, who, however, held the living for only a few

¹⁶ *Cal. S. P. Dom.* 1637, pp. 484-6. For Gorsuch and his parishioners see also *Lords' Journ.* ix, 389.

¹⁷ Hutton, *The Engl. Church*, 1625-1714, p. 51.

¹⁸ *Cal. S. P. Dom.* 1637-8, p. 492.

¹⁹ Hacket, *Scrinia Reserata*, 97.

²⁰ *S. P. Dom. Chas. I*, cclxi, *passim*.

²¹ *Ibid.* fol. 90.

²² *Ibid.* fol. 102.

²³ *Ibid.* fol. 60.

²⁴ Clutterbuck, *op. cit.* iii, 307 n.; *Dict. Nat. Biog.*

²⁵ Newcourt, *Repert.* i, 904.

ECCLESIASTICAL HISTORY

months, being succeeded here by Isaac Craven, a man of an entirely different school of thought. Chauncey had been convented before the High Commission Court in the spring of 1629–30 for saying in a sermon that idolatry had been admitted into the Church, together with much atheism, popery, Arminianism and heresy.²⁶ Religious opinion at Ware was sharply divided in 1633, and Chauncey seems to have found himself in such continual opposition to Sir Thomas Fanshaw²⁷ of Ware Park as to need a special episcopal admonition to be present at the consecration of the domestic chapel of Sir Thomas. In 1633 a general meeting of the parishioners was held, and with the consent of the majority the churchwardens arranged ‘that the communion table should be placed in the chancel and a rail set round about it.’ The consent of the bishop and his chancellor was obtained, but the plan was strongly opposed by Mr. Chauncey, ‘who professed that he would thereupon leave the place, and gave out that the parishioners had set up that rail and bench of purpose to drive him away.’²⁸ The work was carried out while Chauncey was at his living of Marston St. Lawrence, but Humphrey Packer, a yeoman of Ware, at once journeyed thither with the news. Chauncey returned to Ware and stayed at Packer’s house, where he ‘used reproachful speeches against the setting up of the rail and bench and the lawfulness thereof, and affirmed that it was an innovation, a snare to men’s consciences, superstitious, a breach of the second commandment, an addition to God’s worship, and a block in the way of Mr. Craven,’²⁹ the new vicar. Craven does not seem to have viewed the matter in the same light, for in June 1634 he was associated with Sir Thomas Fanshaw in bringing Chauncey’s words to the notice of the Court of High Commission.³⁰ The case dragged on through the following autumn, and it was not until April 1635 that witnesses were sworn.³¹ Sentence was delivered in November, when the court pronounced Chauncey guilty of contempt of the ‘ordinary and the jurisdiction ecclesiastical, and of raising a schism and distraction in the parish of Ware.’ Chauncey was suspended until such time as he should make submission in a prescribed form and was condemned in costs.³² Packer, who had said that the rails could be put to better use in his garden,³³ was also condemned in costs and called upon to make submission, while both men were committed until they should find bonds ‘in £100 apiece for the performance of the order of the court.’³⁴ To his life-long regret Chauncey submitted, and in open court made the prescribed recantation, in which he was made to acknowledge ‘that kneeling at the Sacrament was a Lawful and Commendable gesture, that the Rail set up in the chancel with a Bench thereunto annexed, for kneeling at the Holy Communion, was a decent and convenient Ornament,’ and further to promise ‘never by Word nor Deed to oppose either that, or any other Laudable Right or Ceremony prescribed in the Church of England.’³⁵ Finally he was dismissed with an exhortation

²⁶ Rushworth, *Hist. Coll.* ii (1), 34.

²⁷ Chauncey, *The Retracting of Mr. Charles Chancy*, 17.

²⁸ *Cal. S. P. Dom.* 1635–6, p. 123.

²⁹ *Ibid.* 124.

³⁰ Chauncey, *op. cit.* Introd. ; *S. P. Dom. Chas.* I, cclxi, fol. 60 et seq.

³¹ *Cal. S. P. Dom.* 1634–5, p. 188.

³² *Ibid.*

³³ According to Chauncey (*op. cit.* 35) Packer said ‘of the raile whilst it was in the Joyner’s shop’ that if they ‘did not like them, hee would buy them for his garden.’

³⁴ *Cal. S. P. Dom.* 1635–6, p. 124.

³⁵ Rushworth, *Hist. Coll.* ii (1), 316. Chauncey pleaded that he had set up a rail at Marston St. Lawrence (*Cal. S. P. Dom.* 1635–6, p. 124). For his conduct of the services there see *ibid.* 1635, pp. 489–90.

A HISTORY OF HERTFORDSHIRE

from Laud. The case was bound to create much sympathy with the minister, and years afterwards when Chauncey was in America the parishioners of Ware begged him to return; he was actually on his way when he accepted the invitation to become the first president of Harvard College.³⁶

That disturbances were frequent at this date there is ample evidence to prove, and the trouble generally centred round the communion rails. What was, perhaps, the first outrage was committed at Much Hadham, where Dr. Thomas Paske had set up rails and inserted new painted glass in the east window.³⁷ Three men of Hadham, who 'did not like the rails nor the pictures of the window,' promised the blacksmith and two others money if they would take them down,³⁸ apparently during the rector's absence one day in August 1640.³⁹ The affair was attributed to the soldiery, but there seems no doubt that the actors were local men, as William Lord Salisbury wrote to Secretary Windebank that the three that 'pulled the window down . . . might easily have been prevented and apprehended, if the town had not connived at it.'⁴⁰ His report brought a request from the council to the justices for a note of any riots or profanation of churches; the return made showed that in five churches in Broadwater Hundred the altar rails had been pulled down by the soldiers.⁴¹ The action seems to have met with general approval, for though their number in no case exceeded five, and they entered either by finding the door open or by fetching the key, no one would identify the rioters.⁴² More serious was the outrage at King's Walden, where Puritan feeling seems to have been strong. Here 'on Sunday, during divine service, 24 soldiers entered . . . and sat in the chancel till the sermon was ended, and then, before all the congregation, they tore down the rails and defaced the wainscot, inviting themselves to the churchwardens to dinner, exacted money from the minister, brought an excommunicated person into church and forced the minister to read evening prayer in his presence.'⁴³

In 1641 orders were issued by both Houses for the removal of the altar rails,⁴⁴ and these were generally carried out, though Henry Hancock, the pugnacious vicar of Furneux Pelham, 'walked with his Sword about the Church-yard in the night, saying, "he would rather loose his life, than suffer them to be pul'd up."' ⁴⁵ At Tewin when the rails were removed John Mountfort 'placed formes instead of them,' ⁴⁶ a device probably adopted elsewhere.

While moral and disciplinary cases were being tried in the Court of High Commission, and smaller offences, such as absence from church, were coming before the justices of the peace,⁴⁷ public opinion was becoming more and more definite in hostility to the government of both church and state. The unfortunate association of the bishops with the administration of affairs and their support of the theory of divine right lent point to the academic Presbyterianism of the Puritans of the older school with their yearning after primitive order. In Hertfordshire the divergence of policy evident between

³⁶ *Dict. Nat. Biog.*

³⁷ *Cal. S. P. Dom.* 1640, p. 580.

³⁸ *Quarter Sess. R.* (Herts. Co. Rec.), i, 64.

³⁹ *Ibid.* 68.

⁴⁰ *Cal. S. P. Dom.* 1640, p. 580.

⁴¹ *Ibid.* 1640-1, pp. 69-70. At Rickmansworth eight soldiers impressed in the county entered the church and broke down the communion rails after morning service; in the afternoon they defaced the font cover (Urwick, *op. cit.* 307).

⁴² *Cal. S. P. Dom.* 1640-1, p. 70.

⁴³ *Ibid.*

⁴⁴ Shaw, *Hist. of Engl. Church*, 1640-60, i, 106.

⁴⁵ White, *First Century of Scandalous and Malignant Priests*, 17.

⁴⁶ *Ibid.* 45.

⁴⁷ *cf. Cal. S. P. Dom.* 1625-49, p. 526.

ECCLESIASTICAL HISTORY

Laud and Juxon, Bishops of London, and Williams, Bishop of Lincoln, must have led to a questioning of episcopal jurisdiction that could not fail to be disturbing, while the failings and misfortunes of Williams were matters of common knowledge.⁴⁸ By 1640 it was evident that it was useless to look to the Crown for reform in the desired direction, while the episcopal reforms were regarded rather as confirmations of abuses. The whole trend of public events pointed to the Parliament as the only way of escape from what many regarded as an impossible situation, and Parliament was ready to undertake the work. The religious policy of the Commonwealth was the direct outcome of the policy of Henry VIII. Thus to the Parliament of 1640 were presented petitions which may be compared with those addressed to King James in 1604.⁴⁹ The petition from the diocese of Lincoln asked for action against the increase of Popery, idle and frivolous ceremonies and the profanation of the Lord's Day; it further objected to the canons, and prayed that no canon might be made without consent of Parliament, while a further clause was directed against the restrictions on the periods within which marriages might be legally celebrated.⁵⁰ Besides this a further petition was presented from Hertfordshire, and this boldly demanded the abolition of episcopacy. It is noteworthy that the petition was brought into the House by Arthur Capell,⁵¹ who for many years had represented the county of Hertford and was well known for the moderation of his views. The most important of the petitions thus presented was that of 700 to 800 ministers. A committee was appointed to consider the points raised by this and to report heads for debate by the House. The committee referred as suitable for discussion the questions of the secular employment of bishops, the large revenues of deans and chapters and the sole power of the episcopate in ecclesiastical matters.⁵² Feeling itself in need of expert assistance, the House gave audience to certain chosen divines. The spokesman of those called in to defend the existing state of affairs was Ralph Brownrigg,⁵³ rector of Barley and a scholar whose 'great wit was not forced, frothy or affected, but native, apt and free.'⁵⁴ Essentially a moderate man, he had 'a particular esteem for the Liturgy,' while, according to his biographer, 'if against anything (next sin and gross errors) he had an antipathy and impatience, it was against those unquiet and pragmatick spirits which affect endless controversies, varieties and novelties in Religion, that hereby they may carry on that study of sides and parties in which they glory; and under which skreen they hope to advance their private interests and politick designs.'⁵⁵ To him was opposed another Hertfordshire divine, Cornelius Burgess, who had been vicar of Watford since 1618⁵⁶ and from 1626 also rector of the City living of St. Magnus.⁵⁷ Though one of the chaplains in ordinary to Charles I, he had been brought into the High Commission Court for a sermon preached in 1635 containing aspersions against the bishops, and was charged with being

⁴⁸ Laurence Osbaldeston, who was found guilty with Williams of slandering Laud, was collated by Williams to the living of Wheathampstead in 1635. After the trial he absconded. Laud presented to the living thus vacant and succeeded in establishing his nominee after some opposition from Williams. Osbaldeston was restored by the Long Parliament in 1642, but was ejected in 1655 (Urwick, *op. cit.* 472; Clutterbuck, *op. cit.* i, 517).

⁴⁹ See above.

⁵⁰ D'Ewes, *Diary*, i, 8.

⁵¹ Rushworth, *Hist. Coll.* ii, 1127-8.

⁵² Shaw, *op. cit.* i, 47.

⁵³ D'Ewes, *Journal*, iii, 937.

⁵⁴ Gauden, *A Sermon preached . . . at the Funeral of . . . Dr. Brownrigg*, 147. Brownrigg was made Bishop of Exeter in 1641.

⁵⁵ *Ibid.* 166, 169.

⁵⁶ Newcourt, *Repert.* i, 906.

⁵⁷ *Ibid.* 399; *Dict. Nat. Biog.*

A HISTORY OF HERTFORDSHIRE

a 'vexer of two parishes with continual suits of law,' this possibly referring to the tithe case which he prosecuted during the years 1629-34.⁶⁸ In spite of his love of power he was not an extremist, and his 'Vindication' shows that he disapproved of active rebellion. He may be regarded as the spokesman of the Moderate Presbyterian party.

While the Lower House was busy with petitions the House of Lords had appointed its own committee for Religion 'to take into Consideration all Innovations in the Church,'⁶⁹ with power 'to send for such Learned Men as their Lordships shall please, to assist them.'⁶⁰ Laud in his Diary noted that the members consisted of 'ten Earls, ten Bishops, ten Barons,'⁶¹ his old enemy Williams being among the number. Williams, indeed, presided over the body, and must have been instrumental in co-opting Holdsworth Archdeacon of Huntingdon, Hacket his own chaplain, Brownrigg and Burgess, all of whom were among those most constant in their attendance at the meetings.⁶² Williams was as much distinguished for his tact as for his moral laxity, but his task must have been one of considerable difficulty. There was much discontent in his own diocese, and a sub-committee of the Lower House was appointed to examine the 'Matters of Complaint concerning Religion' there and especially the abuses in the ecclesiastical courts; in December this sub-committee was made a committee of the House.⁶³

By 1642 the clumsy method of calling in divines for consultation by the Houses was dropped in favour of the permanent council which was to earn such fame as the Westminster Assembly. The members were elected by the House of Commons from names proposed by the burgesses and knights of the shire, Brocket Smith, D.D., of Barkway and Cornelius Burgess, D.D., of Watford being chosen for Hertfordshire.⁶⁴ Herbert Palmer, B.D., of Ashwell and Richard Vines of Caldecote were also members,⁶⁵ and Burgess became one of the assessors.⁶⁶ While the Parliament was thus preparing an instrument for the exercise of the spiritual functions of the episcopate it was arrogating to itself the administration of the dioceses. Thus in May 1642, when the living of St. Peter's in St. Albans was about to be filled by the Bishop of Ely, the House of Lords sent a peremptory order requiring him to certify to whom he had presented the living before he actually collated his nominee.⁶⁷ At the same time the system of lectureships was being promoted by the House, and it lent its powers of coercion in April 1642 to force the vicar of Broxbourne to accept as lecturer Daniel Evans, whom some of the inhabitants of that town had undertaken to support.⁶⁸ A similar order was made on 6 June in favour of Philip Goodwin, who was settled as lecturer on Sunday afternoons and Thursday mornings at Hemel Hempstead,⁶⁹ while some three weeks later Parliamentary sanction was given to the establishing of a Monday lecture at Berkhamstead St. Peter.⁷⁰ The most elaborate lectureship at this time was that appointed for Tuesdays at Hitchin; this was served by fifteen ministers in turn.⁷¹

⁶⁸ Lambeth MS. ix, 62. ⁶⁹ *Lords' Journ.* iv, 174. ⁶⁰ *Ibid.* 177. ⁶¹ Rushworth, *Hist. Coll.* ii, 1088.

⁶² Hacket, *Scrinia Reserata*, ii, 147. ⁶³ *Commons' Journ.* ii, 56.

⁶⁴ Peacock, *The Army Lists of the Roundheads and Cavaliers*, 63-4.

⁶⁵ Hetherington, *Hist. of the Westm. Assembly*, 109.

⁶⁶ *Ibid.* 111.

⁶⁷ Shaw, *Hist. of Engl. Church*, 1640-60, ii, 181.

⁶⁸ *Commons' Journ.* ii, 538.

⁶⁹ *Ibid.* 608; cf. 730 (22 Aug.), where George Kendall was appointed Lecturer.

⁷⁰ *Ibid.* 639.

⁷¹ *Ibid.* iii, 681.

ECCLESIASTICAL HISTORY

Although in course of time Parliament arrogated to itself the whole functions of the episcopacy in discipline, ordination, institution, collation and administration, the system was somewhat slow in growth. In 1643, however, the Parliamentary claim to control the theology, morals and politics of the clergy was fully stated both in word and action. The number of recorded ejections in this county was nineteen, all but one of which were carried out in 1643. The first case dealt with was that of Dr. George Seaton, who had succeeded the Puritan divine Edmund Staunton at Bushey in 1631.⁷² The Commons ordered the sequestration of the living on 26 January,⁷³ and on 1 February the Lords decided to inquire on what evidence the action of the Lower House had been based.⁷⁴ Sequestrators were appointed by both Houses a week later,⁷⁵ and on 11 July Marmaduke Browne, M.A., a 'godly, learned and orthodox divine,' was settled as parson of Bushey.⁷⁶ It is impossible to feel that the decrees of both the Parliamentary and county committees were other than arbitrary.⁷⁷ Apparently on the report of the local commissioners the Commons passed an ordinance for sequestrating the profits of the living to the use of their nominee; the committee at St. Albans then called witnesses, but in every known case the sequestration was completed. The vast accumulation of work thrown upon the Houses when they assumed the government of the kingdom led in 1654 to the delegation of the work of the Parliamentary committee to local commissioners. For Hertfordshire the matter was placed in the hands of Henry Lawrence, Lord President of the Council, Sir John Wittewronge, John Fiennes, John Marsh, Francis White, Isaac Puller, William Turner of Hertford, Alban Cox, Master Combes the younger of Hemel Hempstead, Colonel Washington, Thomas Nicholl, William Leman, Ralph Gladman, William Packer and William Hickman.⁷⁸ These or any five of them were to act with five or more local divines—Philip Goodwin, John Warren of Thorley, John Lightfoot of Great Munden, Samuel Tomlin, Thomas Mocker of Gilston, Thomas Halsiter, John Young, Isaac Bedford of Willian, Nathaniel Eeles, William Tutty of Totteridge, 'Mr. Slater,' John Pointer, Daniel Dyke of Much Hadham, and 'Mr. Lee of Hatfield.'⁷⁹

Clergy were removable in 1654 'for ignorance, insufficiency, scandal in their lives and conversations, or negligence in their respective callings and places,'⁸⁰ but in 1643 the ground of the ejection was generally political, though theological antipathies were the cause in some cases and a few men were charged with moral offences. It is noticeable, however, that whereas serious charges of moral misconduct were brought against various Essex clergy,⁸¹ but one accusation of the kind is heard of in the case of the clergy of this county.⁸² It may be well here to review what little evidence has been found bearing on the personal conduct of the clergy during the late 16th and early 17th centuries. From the first the Puritans, with their fine insistence on personal morality, had striven to improve clerical as well as lay morals. If the deanery of Braughing may be regarded as typical, the

⁷² Newcourt, *Repert.* i, 816.

⁷³ *Commons' Journ.* ii, 944.

⁷⁴ *Lords' Journ.* v, 584.

⁷⁵ *Ibid.* 594.

⁷⁶ *Commons' Journ.* iii, 161.

⁷⁷ cf. Add. MS. 15669.

⁷⁸ *Acts and Ordinances of the Interregnum*, ii, 971.

⁷⁹ *Ibid.* 980; Calamy, *Nonconformists' Mem.* (ed. 1802), ii, 303, 304, 313-15.

⁸⁰ *Acts and Ordinances of the Interregnum*, ii, 977.

⁸¹ White, *The First Century of Scandalous Malignant Priests.*

⁸² *Lords' Journ.* v, 667.

A HISTORY OF HERTFORDSHIRE

clergy in 1576 were generally married.⁸³ No Puritan *comperta* such as those made for Staffordshire⁸⁴ and elsewhere exist for this county, though the commissioners, naïvely enough, expressed their opinion that a survey was 'verie likelie to be as badde as others.'⁸⁵ The case of Edward Spendlove has been already mentioned. In January 1593 a return of the clergy in the archdeaconry of St. Albans showed that all the Hertfordshire ministers were 'of good life and conversation,' though William More, vicar of St. Peter's, had been 'detected by Mr. Archdeacon for suspicion of evil life,' but had purged himself thereof.⁸⁶ The social position of the clergy had improved as steadily as their learning, and the personal defects charged against them in 1643 were the defects usual among the gentry of the day. Thus Joseph Soane, vicar of Aldenham, was sequestered for being 'a common gamester, a Common Ale-house haunter, and frequently drunke, and a common quarreller,'⁸⁷ while similar charges were brought against Philip Leigh, vicar of Redbourn,⁸⁸ and Henry Hancock, vicar of Furneux Pelham, who was further characterized as 'a prophane swearer of bloody oathes.'⁸⁹ Griffith Roberts, vicar of Ridge, was described as 'a common drunkard and tipler in Ale-houses, and drinker of healths, quarrelling with them that will not pledge him therein,' a description that points to politics as the real ground of offence.⁹⁰

Of more importance are the charges of innovation in the conduct of services and in doctrine. There was of course considerable variety of opinion even among Puritans, but men like Staunton, vicar of Bushey (1627-31),⁹¹ would urge their parishioners to communicate at other seasons as well as at Easter,⁹² and Chauncey spoke of celebrations lasting 'two or three houres' together as the rule 'in many popular Congregations.'⁹³ The services of the 'malignant' clergy are well described in the charges brought against them. Dr. Mountford, rector of Anstey, was accused of having turned 'the Communion Table Altarwise, and having a great Crucifix and Picture of the Virgin Mary in the East-window . . . used bowings and cringings before the said Table and Crucifix . . . and caused the said Table to be railed in, and the Jesuits Badge to be set upon the Carpet'⁹⁴ there, compelling the people to come up to the rail, there to kneele to receive the Sacrament, teaching them "that God was always present at the Altar by the presence of his Grace, and was therefore to be bowed unto," and in his going up to the Table to reade second Service, usually caused that part of the 43 Psalme to be sung viz. Then shall I to the Altar goe, of God, &c.'⁹⁵ Richard Taylor, parson of Buntingford, Westmill and Aspenden, had 'not only used frequent bowings to the Communion-table set Altar-wise, but affirmed that there was

⁸³ Lambeth MS. xii, no. 1. The proportions were six bachelors to twenty-nine married men.

⁸⁴ *English Hist. Rev.* xxvi, 338.

⁸⁵ Morrice MS. (Dr. Williams's Lib.), B, fol. 51.

⁸⁶ *Rec. of the Old Archd. of St. Albans*, 87. More was suspended at this time for failure to preach, perform exercises and catechize (*ibid.*).

⁸⁷ White, *op. cit.* 7.

⁸⁸ *Ibid.* 4.

⁸⁹ *Ibid.* 17.

⁹⁰ *Ibid.* 12.

⁹¹ Newcourt, *Repert.* i, 816.

⁹² Staunton, *A Dialogue . . . between a Minister and a Stranger*, 141-2.

⁹³ Chauncey, *op. cit.* 33.

⁹⁴ This 'carpet' still belongs to the church. It is of plum-coloured velvet, and was probably made to cover the top, front and side of the altar; its dimensions are 7 ft. 3 in. by 4 ft. 9 in., these measurements including the fringe of green silk mixed with gold, which is 2½ in. deep. A large oval medallion is worked upon the frontal in green and gold; it is surrounded with rays and has in the centre $\frac{I \cdot H \cdot S \cdot}{1637}$. This altar

cloth was exhibited (exhibit 253) at the Church History Exhibition held at St. Albans, 1905.

⁹⁵ White, *op. cit.* 13.

ECCLESIASTICAL HISTORY

a more peculiar presence of God there than in the Church'; he pressed his people to bow three times at their coming into the church. And further 'there being a Crosse at the head of the Font in his Church, upon every approach . . . used to bow to it.' Complaint was also made that he had urged some of the parish to make auricular confession to him, and that he kept in his parlour a picture of Christ to put him in mind of his Saviour. As surrogate he was said to 'improve his authority to introduce the late Innovations.'⁹⁶ He further shocked the susceptibilities of his parishioners by declaring the fourth commandment to be 'meerely ceremoniall,' and accordingly would 'hire servants, ride journeys, buy wood and send his Hopps to market on the Lord's Day.'⁹⁷ Mr. Horwood, a successor of Soane at Aldenham, annoyed his people by carrying himself 'very superstitiously . . . in kneeling downe to his devotion upon the staires leading up to the pulpit when he went up to preach.' But still more important from the point of view of the Parliament were the political views held by these clergy. Thus Humphrey Tabor, vicar of All Saints', Hertford,⁹⁸ refused 'to read the orders and ordinances of Parliament or obey the Commands thereof, as not of any Authority.'⁹⁹ John Taylor of Hemel Hempstead was so outspoken in his expressions of malignity 'against the Parliament and the Power and Proceedings thereof' that he was sent to prison,¹⁰⁰ while Robert Pory,¹ parson of Thorley, besides affirming a Puritan to be a 'Limb of the Devil,' abused the Scots, 'publicly affirming them to be damned Rogues, and them that took their Parts.'² He refused to read Parliamentary ordinances, but they were read by another, and it is recorded that Pory 'flung out of the Church, calling such as he met to go out with him, and not to stay to hear (as he called it) a kind of bibble-babble Things, to no purpose at all.'³

It was evident that the mere ejection of malignant clergy was not enough to secure conformity. Many advowsons were in the gift of Royalist families, and Parliament decided to confiscate such property in the national interest. The Houses, however, realized their incompetence to deal with the technical questions involved in deciding the suitability of candidates for the ministry, and this duty was delegated to the Assembly of Divines.⁴ The first incumbent to be instituted under this system was Richard Brookes, rector of Puttenham,⁵ and various other cases occur during 1646-8.⁶

Nothing but admiration can be paid to the manner in which the various Parliamentary committees attacked difficult problems of administration, some of which still trouble the church. Thus ordinances were passed to regulate pluralities and non-residence,⁷ while parishes were divided as in the case of Wheathampstead, from which in 1656 Harpenden was separated.⁸ Parochial

⁹⁶ White, *op. cit.* 38.

⁹⁷ MS. exhibited by Lord Aldenham at the English Church History Exhibition, St. Albans, 1905.

⁹⁸ He had been presented to the living by Charles I in Feb. 1638-9 (*Cal. S. P. Dom.* 1638-9, p. 505) on the cession of Archer, the previous vicar, who had deserted his cure (*ibid.* 1637-8, p. 563).

⁹⁹ *Lords' Journ.* v, 662.

¹⁰⁰ *Ibid.* 667.

¹ Pory was made archdeacon of Middlesex in 1660 (Hennessy, *Novum Repert.* 9).

² *Lords' Journ.* v, 690.

³ *Ibid.*

⁴ cf. *ibid.* ix, 26, in the case of William Turnour, vicar of Barkway.

⁵ *Ibid.* viii, 130.

⁶ *Ibid.* 257 (St. Andrew's, Hertford); ix, 652 (Digswell); 96 (Radwell); 444 (Ashwell); 567 (Barley); 612 (Little Horstead); x, 403 (St. Albans); 579 (Barkway).

⁷ See Shaw, *op. cit.* i, 110-11; ii, 188.

⁸ *Cal. S. P. Dom.* 1656-7, p. 96.

A HISTORY OF HERTFORDSHIRE

endowments were also considered and grants made in augmentation, such as the £50 allowed in 1656 to the minister of Offley and the sums allowed in January 1658-9 to Watford and [King's] Walden.⁹

With the restoration of the monarchy in 1660 came the re-establishment of the Church of England. It is difficult to say what was the exact number of ejections of Parliamentary clergy, but changes took place in at least forty-one cures in this county in the first few years of the reign.¹⁰ In many cases the living was handed back to the incumbent whom the Parliament had disseised. Thus Herbert Thorndyke returned to his living of Barley,¹¹ his whilom successor, Nathaniel Ball, finding employment as public preacher of Royston, where he held a lecture on market days until silenced by the Act of Uniformity of 1662.¹² Such cases made no appearance in the episcopal registers. Within that part of the diocese of London which lay in Hertfordshire eight institutions were made between 25 March 1661 and 25 March 1662 on the removal or resignation of the intruding incumbents of Amwell, Reed, St. Peter's and St. Stephen's in St. Albans, Anstey, Codicote, Hunsdon, Brent Pelham, Ware and Watford.¹³ The ministers thus displaced do not, however, appear to have been in the first rank of importance, Philip Goodwin of Watford being the only 'Tryer' among them.¹⁴ Proceedings against them may possibly have been somewhat in the nature of a threat, for Goodwin held preferment in Essex until his death.¹⁵

In the autumn of 1661 work was begun on the revision of the Book of Common Prayer, and in May 1662 the Act of Uniformity passed into law.¹⁶ This Act required episcopal ordination from all beneficed clergy, and made the use of the revised Prayer Book compulsory; it also required an undertaking to observe conformity from all clergy and schoolmasters. The Act came into force on St. Bartholomew's Day (24 August), 1662, and was followed by numerous cessions of the clergy. Although but eight institutions to livings in Hertfordshire apparently vacant through the Act have been traced in the London episcopal registers,¹⁷ and four in those of the diocese of Lincoln,¹⁸ the number of displaced clergy was probably considerable,¹⁹ and most of the prominent Puritan ministers now devoted their talents and piety to the small bodies of separatists which sprang into being all over the country.²⁰ Their conviction was probably obtained through the working of the visitations which accompanied the Act. The Articles of Inquiry were particularly minute in character, sections dealing with the church and its ornaments, the minister, the parishioners, parish clerks, sextons, schoolmasters, midwives and physicians. The churchwardens were required to answer whether their minister had had episcopal ordination and institution and whether he was resident and a preacher. One inquiry was whether he 'read the prayers distinctly, gravely, plainly and with due attention and reverence,' without omissions; another whether he observed Holy Days and Fasting

⁹ *Cal. S. P. Dom.* 1656-7, p. 164; 1658-9, p. 254.

¹⁰ Newcourt, *Repert.* i, *passim*; Calamy, *Nonconformists' Mem.* (ed. 1802), *passim*; Harl. MS. 7048.

¹¹ Newcourt, *Repert.* i, 800.

¹² Calamy, *op. cit.* ii, 309.

¹³ Newcourt, *Repert.* i, 789, 790, 797, 824, 840, 854, 904, 906.

¹⁴ See above.

¹⁵ Newcourt, *Repert.* ii, 393.

¹⁶ Stat. 13 & 14 Chas. II, cap. 4.

¹⁷ Newcourt, *Repert.* i, 788, 792, 800, 816, 826, 842, 848, 896.

¹⁸ Harl. MS. 7048, fol. 249b.

¹⁹ Calamy, *op. cit.* ii, *passim*.

²⁰ See below. For the conforming vicar of Hatfield see Wilde, *The Recantation of a Penitent Proteus*

ECCLESIASTICAL HISTORY

Days, the Ember weeks and Rogationtide ; another asked whether he did or did not wear surplice and hood.²¹ These were for the Puritan ; for the restored Royalist the questions were whether his hair was of an immoderate or uncomely length,²² whether he wore ‘any coif, and wrought night caps, or only plain night caps of silk, sattin, or velvet,’ whether he wore ‘any light-coloured stockings,’ or whether his dress was the ‘gown with a standing collar, and wide sleeves strait at the hands, and a square cap’ prescribed by the canon.²³

The returns for the archdeaconry of St. Albans have been preserved.²⁴ They show that the services and usage of the Church of England were being restored without much difficulty though William Joel, vicar of Sarratt, confessed that ‘he did not constantly use the Surplis, nor Read the Prayers accordinge to the Rubrick’ ; moreover, the churchwardens ‘declared that he could not Read y^o Prayers for y^o Queene and the Duke.’ ‘My lord monished him,’²⁵ and apparently Joel heard no more of the matter, for he was vicar until his death in 1702.²⁶

Joel’s attitude towards Roman Catholicism was probably that of the majority of Hertfordshire folk both clerical and lay, for when James II was succeeded by William and Mary very few in this county refused to take the oath to the new rulers.²⁷ In the archdeaconry of Huntingdon Alexander Horton, rector of Norton, was deprived, and the same fate met Richard Milles, vicar of Ridge, and William Sherlock, the controversialist rector of Therfield, who both, however, afterwards complied.²⁸ The curates of Eastwick and Cheshunt were also nonjurors, while the oath was refused by Arthur Battel, an usher at Hertford School, by Aaron Hodgson, an usher at Stanstead Abbots, and by one Pulford, who may have been a layman.²⁹ The most distinguished of this small body was Nathaniel Salmon,³⁰ who gave up his curacy of Westmill and devoted the rest of his life to that study of the antiquities of the county that produced his *History of Hertfordshire*.

This ejection of High Churchmen following that of the extreme men of the opposite school left the moderates in possession. Unfortunately that fear of enthusiasm which is always present with those in authority had spread to the middle classes ; preaching had lost its novelty, sacramental teaching had been allied with abandoned political theories and survived their discredit hardly. The Restoration had been followed by a great revival of religious zeal that found expression in London in the building of churches and the forming of the great missionary societies.³¹ In the country no such salient features of the change present themselves, but the stimulus was both needed and felt, for there was much work to be done to the fabric of the churches and to their equipment. Still more serious was the necessity laid

²¹ *Articles to be enquired of within the Archdeaconry of St. Albans* . . . 1662 ; *Articles to be enquired of within the Archdeaconry of Middlesex*, 1662.

²² *Articles to be enquired of within the Archdeaconry of St. Albans* . . . 1662.

²³ *Articles to be enquired of within the Archdeaconry of Middlesex*, 1662.

²⁴ Visit. 1662 (Lond. Epis. Reg.).

²⁵ *Ibid.*

²⁶ Urwick, op. cit. 335 ; Newcourt, *Repert.* i, 883. He had married in 1662 Mary widow of Henry Child, the patron of the living (Urwick, loc. cit.).

²⁷ Overton, *The Nonjurors*, 481.

²⁸ *Ibid.* 486 ; Newcourt, *Repert.* i, 874 ; Visit. 1680 (Lond. Epis. Reg.) ; Urwick, op. cit. 821 n. ; *Dict. Nat. Biog.*

²⁹ Overton, op. cit. 472, 481, 890. Charles Bankes is here called vicar, not curate, of Cheshunt, but this seems to be a mistake (Newcourt, *Repert.* i, 822).

³⁰ Overton, op. cit. 491 ; *Dict. Nat. Biog.*

³¹ See *V.C.H. Lond.* i, 341, 353-4.

A HISTORY OF HERTFORDSHIRE

upon the clergy of reconciling their people to the services and teaching of the re-established Church.

The repair of the fabric of the church other than the chancel was the duty of the parishioners, and the charge was usually met by a church rate; the obligation seems to have been generally discharged during the Commonwealth period,³² but the chancels had suffered, as the rectors, if lay, were often Royalists with sequestrated estates, or if clerics were frequently doubtful of their tenure, especially during the later years of the Protectorate. Thus at Aldenham, where the rectory was in the hands of the lord of the manor, the chancel was in 1666 in such ruin as to be unusable, and the court of the Archdeacon of Huntingdon 'ordered that a curtain of baize or some other thick material should be hung up between the ruins of the said chancel.'³³ Nothing further was done for some months, but in 1667 the vicar was ordered to say prayers in the nave, as 'the roof was fallen down in the part over the reading pew or desk of the minister.' Since no remedy could be obtained from the lay rector, recourse seems to have been had to a church rate.³⁴

Internally the churches underwent considerable alterations. The galleries which Wren and his followers put into the London churches to increase their seating accommodation set a fashion which was followed in the country. The motive for their adoption in Hertfordshire is not very clear. Returns of accommodation in the churches were made to the Bishops of Lincoln at the beginning of the 18th century, and were compared by them with the estimated population and number of Dissenters,³⁵ but the galleries seem generally to have been private erections. That built in Benington Church by the Dods³⁶ was probably used as a family pew, as was that built at the west end of Braughing Church by Ralph Freeman.³⁷ In other cases they were provided for school children; that at Aldenham 'was erected by the worshipful Company of Brewers, London, trustees of Richard Platt, citizen of London, deceased, in the year 1686' for the use of the master and scholars belonging to the free school of Aldenham, founded by the said Richard Platt.³⁸ At Ware 'a handsome Gallery at the West End of the church' was built by the governors of Christ's Hospital for their 'colony of children.'^{38a} At Bishop's Stortford the trustees out of rents for beautifying the church built one gallery, while the parishioners, not to be outdone, subscribed for the building of a gallery on the north side for 'the young gentlemen of the school,'³⁹ successors of the youths whose good order and diligence in noting the sermon had been commended to Laud in 1636.

One of the articles of inquiry of 1668 was whether there was 'a decent Font of stone with a cover' standing 'at or near the neather end of your Church, in such manner as anciently and usually Fonts have stood for the baptizing of children,' or whether it had 'been removed and converted to any profane or private use.'⁴⁰ In most cases the fonts remained.⁴¹ One

³² *Quarter Sess. R.* (Herts. Co. Rec.), i, 114; Besse, *A Coll. of the Sufferings of the People called Quakers*, i, 240-1.

³³ Urwick, *op. cit.* 251.

³⁴ *Ibid.* Henry Coghill and W. Briscoe refused to contribute. Coghill had objected to a similar rate in 1637 (*Cal. S. P. Dom.* 1637, p. 575).

³⁵ 'Speculum Dioecesis' (Doc. in Alnwick Tower, Linc.).

³⁶ Salmon, *Hist. of Herts.* 196.

³⁷ *Ibid.* 231.

³⁸ Clutterbuck, *op. cit.* i, 136.

^{38a} Salmon, *op. cit.* 248.

³⁹ *Ibid.* 272.

⁴⁰ *Articles to be enquired of within the Archdeaconry of St. Albans . . . 1662*, p. 1.

⁴¹ *cf. Rep. of Rty. Com. on Hist. Mon. of Herts. passim.*

ECCLESIASTICAL HISTORY

exception, however, was at Berkhamstead St. Peter, where the Baptists were strong in numbers⁴²; here a new marble font was given to the church by Francis Wethered, comptroller of the works to Charles II.⁴³ The fine hangings provided for the chapel of Chelsea Hospital and other London churches at this time found their counterpart in the cushion and pulpit cloth of crimson velvet fringed and embroidered with gold given by Mrs. Bird of Mardocks to the church of Ware in 1694,⁴⁴ in the purple cloth and cushion and 'Suit of Dammask Linen' given to Hitchin in 1704,⁴⁵ in the altar-cloth of 'Red cloth, with gold and Silk Fringe embroider'd with Gold: The Pulpit-Cloth and Cushion of the same Cloth and Embroidery' given to Little Berkhamstead,⁴⁶ and in many other gifts of the same time. Still more extensive were the gifts to Widford Church made by John Plummer of Blakesware, who in the autumn of 1708 set up there a new pulpit with a purple cushion and in 1712 gave a new communion table furnished with a purple 'carpet.'⁴⁷ The use of liturgical colours seems to have been unknown in Hertfordshire in these early years of the 18th century, but the dislike to pictures in church was not then felt, for about 1703 a Captain Polehampton gave to the abbey church of St. Albans a picture of the 'Last Supper,' which was used as a reredos throughout the century.⁴⁸ A 'branch' or candelabrum was given to Hitchin Church in 1678 and gifts of plate were numerous.⁴⁹

Apart from these minor gifts a good deal of restoration was done, chiefly by the local squires. William Gore of Tring Park was especially active, and in 1714 he relaid the pavement throughout the church with freestone; the pillars were painted and 'a handsome vestry' arranged under the belfry, while Sir Richard Anderson wainscoted the chancel, making it, in the best opinion of his day, 'decent and capacious, and worthy a Choir.'⁵⁰

Anything like a modern trained choir was unknown in the county parish church of the 18th century. At Bishop's Stortford, and probably elsewhere, there had been a choir of men and boys in pre-Reformation days,⁵¹ but no record of it in later times has been found, though Elizabeth's injunctions provided for the maintenance of choirs 'for the comforting of such as delyte in musicke.'⁵² Music was not encouraged by the Puritan clergy, and in Salmon's time almost the only Hertfordshire churches with organs were those of All Saints, Hertford, and Bishop's Stortford.⁵³ Hertford was fortunate in having as vicar Ralph Battell, whose unmarried daughter Mary was organist.⁵⁴ Mr. Battell seems to have had some struggles with the churchwardens over the instrument, for on bequeathing a sum of money for the organist's salary he added the proviso that the trustees should pay for

⁴² Urwick, *op. cit.* 377-8.

⁴³ Salmon, *op. cit.* 126. The churchwardens' accounts (Add. MS. 18772, fol. 173) show that in 1661-3 11s. were given 'to John Turner bringing the font' and £1 to Rich. Ward 'about the font.'

⁴⁴ Salmon, *op. cit.* 249.

⁴⁵ *Ibid.*

⁴⁶ *Ibid.* 26.

⁴⁷ Lockwood, *Widford and Widford Church*, 11.

⁴⁸ Guildhall MS. 43. The picture is still in the church.

⁴⁹ Salmon, *op. cit.* 163; *V.C.H. Herts.* ii, iii, *passim*. See also Topography, above.

⁵⁰ Salmon, *op. cit.* 131; Clutterbuck, *op. cit.* i, 508; 'Speculum Dioecesis.'

⁵¹ Glasscock, *Rec. of St. Michael's*, 41.

⁵² *Injunctions given by the Queenes Maiestie*, 1559, § 49. Sandys in 1571 inquired whether 'such partes onely of the Common prayer be Sung, as by the Booke of Common prayer are appoynted to be Song' (*Articles to be enquired of . . . in the Visitation of the Dioces of London*, § 4).

⁵³ Salmon, *op. cit.* 272; Clutterbuck, *op. cit.* ii, 158.

⁵⁴ Clutterbuck, *loc. cit.* She died in January 1698-9, and on 13 February died Elizabeth Cranmer, who left £200 'for a perpetuall encouragement to the organist' (*ibid.*).

A HISTORY OF HERTFORDSHIRE

the tuning should the churchwardens refuse to do so. Further endowment was provided under the will of Mistress Dyonisia Battell, perhaps sister of Mary, who died in 1730.^{54a} At Bishop's Stortford the organ was perhaps a little later, though there had been one here in the time of Henry VII.⁶⁴ The organ was given by a Mr. Pape, and, says Salmon, 'the expence of so fine an Instrument is great, but chearfully contributed to by the Inhabitants, as well as by other Gentlemen.'⁶⁶ By 1815 Watford had also obtained an organ which stood on the gallery built at the east end of the nave in 1766.⁵⁷ Here as elsewhere the school children were the only trained singers,⁶⁸ but the music was strictly limited in character, being confined by Bishop Gibson in 1724 to the Psalms in 'five or six usual tunes.'⁵⁹ Where there was a school the children would form the choir, and at Hertford the boys of the Green Coat School were required to be taught to sing the psalms and responses in and during divine service.⁶⁰ Singing, however, seems to have fallen into disuse in many village churches, and when John Jones went to Shephall in 1767 he found that there had been none for many years.⁶¹ His ambition was to establish the singing of Psalms v, xxiv, lxxiv, c and civ, and he added that he 'would be contented with these few, being plain and proper tunes, and the words suitable.'⁶² Singing seems to have been revived towards the close of the century,⁶³ and in 1790 Bishop Porteus feelingly described how in most country churches the music was 'generally engrossed by a select band of singers, who have been taught by some itinerant master to sing in the worst manner, a most wretched set of psalm-tunes in three or four parts, so complex, so difficult and so totally void of all true harmony that it is altogether impossible for any of the congregation to take part with them.'⁶⁴

Religious education was not neglected by the Church at this time. The injunctions of 1550 provided that every curate should teach the catechism, whensoever just occasion was offered on Sunday or holy day, and at least once every six weeks should call upon his parishioners and present himself ready to instruct and examine the youth.⁶⁵ Queen Mary required that every parson, vicar or curate upon every holy day and every second Sunday in the year should hear and instruct all the youth of the parish 'for halfe an houre at the leaste, before Evenynge prayer, in the ten commaundementes, the Artycles of the belyefe, and in the Lordes prayer, and dylgentlye examyne them, and teache the Catechisme, sette forth in the booke of publike prayer.'⁶⁶ Articles of 1571 instructed the curate to catechize on Sundays and holy days, and the duty was constantly being urged.⁶⁷ The early Puritans found here an excellent opportunity for expounding their views⁶⁸; in 1603 John Rudd, minister of Shephall, preached every Sunday at least twice, 'in the afternoon referring all his exercises unto catechising, handling either

^{54a} Clutterbuck, op. cit. ii, 175-6.

⁵⁵ Glasscock, op. cit. 28.

⁵⁶ Salmon, op. cit. 272.

⁵⁷ Clutterbuck, op. cit. i, 258.

⁵⁸ *Charge of Edmund Bishop of Lincoln* . . . 1717.

⁵⁹ Gibson, *Directions given to the Clergy of the Diocese of London* (1724), 114-15.

⁶⁰ Clutterbuck, op. cit. ii, 174.

⁶¹ Jones MS. (Dr. Williams's Lib.), B, 16.

⁶² *Ibid.*

⁶³ A pitch pipe once used at Aldbury and a hautboy belonging to the church band at Aldenham were shown at the English Church History Exhibition at St. Albans, 1905.

⁶⁴ Porteus, *Charge to the Clergy of the Diocese of London*, 20.

⁶⁵ *Injunctions geven in the Visitation of* . . . *Nycolas byshoppe of London*, 1550, § 9.

⁶⁶ *Injunctions geven by the Quenes Maiestie*, 1559, § 44.

⁶⁷ *Articles to be enquired of* . . . *in the Visitation of the Dioces of London*, 1571, § 9.

⁶⁸ *Rec. of the Old Archd. of St. Albans*, 45, 54.

ECCLESIASTICAL HISTORY

some choice places of Scripture for that purpose, or insisting on some ordinary catechism,'⁶⁹ and this seems to have been a usual plan.⁷⁰ During the Commonwealth catechizing seems to have been disused,⁷¹ and articles of 1662 inquired whether regular instruction was given to the young before evening prayer, and whether the afternoon sermons had, according to the king's instructions, been turned into catechizing by way of questions and answers.⁷² How greatly the exercise was neglected may be seen from the return made for parishes in the archdeaconry of Huntingdon in 1717⁷³; some attempt was generally made to gather together the children during Lent, but again and again it is recorded that the parishioners are backward in sending their children and servants. Much the same report was made in 1763.⁷⁴ Here and there, as the century progressed, catechizing was regarded seriously. John Jones of Shephall laid down 'catechizing on Sundays and Holy Days' as one of the most important 'duties of a parish priest'; he divided his catechumens into classes, the younger to be instructed in the Church catechism only, the older in a separate class, to be supplied with commentaries.⁷⁵ He was prepared to give separate instruction to 'the more sober and serious who are not yet communicants.'⁷⁶ Porteus was the first Bishop of London to see the importance of Sunday schools, which he persistently advocated.⁷⁷

The articles of 1571 contained inquiries whether any had been admitted to the holy communion 'that cannot say by heart the Ten Commaundements, the Articles of the faith, and the Lordes Prayer in English,'⁷⁸ and knowledge of the catechism would thus seem to have been accepted in place of confirmation. In 1662 the churchwardens were asked if their minister prepared the children and presented them to be confirmed,⁷⁹ and in 1706 the Bishop of Lincoln required candidates to be 'of Age and Ability not only to say, but to understand their catechism' and to be duly prepared.⁸⁰ The returns of 1717 show that the sacrament was much neglected at this time; thus at Shenley many were unconfirmed, and at Caddington 'very few' had been presented to the bishop.⁸¹ In 1770 the Bishop of Lincoln issued an order for a general confirmation, the centres for Hertfordshire being apparently St. Albans, Bishop's Stortford and Stevenage.⁸² The second half of the 19th century saw confirmation take its place among the most important functions of episcopal work, and in 1912 no less than 160 centres were appointed for the diocese of St. Albans.⁸³

⁶⁹ *Rec. of the Old Archd. of St. Albans*, 115.

⁷⁰ *Ibid.* 113-16, cf. 148; Calamy, *Nonconformists' Mem.* (1802), ii, 309.

⁷¹ Gauden, *A Sermon preached . . . at the Funeral of . . . Dr. Brownrig*, 159.

⁷² *Articles to be enquired of within the Archd. of Middlesex*, 1662.

⁷³ 'Speculum Dioecesis' (Alnwick Tower, Linc.); Bp. Gibson's Visit. (Lincoln Diocese), 1717-47 (Lib. of D. and C. of St. Paul's). ⁷⁴ Guildhall MS. 481.

⁷⁵ Jones MS. (Dr. Williams's Lib.), A 39. At Shephall in 1767 he had a class of eleven, five of whom were boys (*ibid.* B 16). ⁷⁶ *Ibid.* A 39.

⁷⁷ Porteus, *Letter to the Clergy of the Diocese of London*, 1788, p. 20; *Charge to the Clergy of the Diocese of London*, 1790, pp. 15-16. A Sunday school was promoted at St. Albans in the winter of 1785 with a view to establishing 'an early habit among the lower class of attending church' (*Cat. Engl. Church Hist. Exhibition*, [St. Albans, 1905], 112). A Sunday school was instituted at Hoddesdon in July 1791. The children were to appear in the schoolrooms at 8 a.m. in summer and at 9 a.m. in winter; at both seasons afternoon school began at 2.30 (Tregelles, *Hoddesdon*, 420).

⁷⁸ *Articles to be enquired of . . . in the Visitation of the Diocesis of London*, 1571.

⁷⁹ *Articles to be enquired of within the Archd. of Middlesex*, 1662.

⁸⁰ *Bp. of Lincoln's Charge*, 1706.

⁸¹ Bp. Gibson's Visit. (Linc. Dioc.), 1717-47 (Lib. of D. and C. of St. Paul's).

⁸² Jones MS. (Dr. Williams's Lib.), B 16. Jones presented three candidates. ⁸³ *St. Albans Dioc. Cal.* 1912.

A HISTORY OF HERTFORDSHIRE

As to the actual services held at the beginning of the 18th century very full information is available in the 'Speculum Dioecesis'⁸⁴ drawn up for Bishop Gibson and based on returns made at a visitation in 1717.⁸⁵ In nearly every parish morning and evening prayer was said on Sundays⁸⁶ only, but at Caddington the rector said it once daily,⁸⁷ and at Caddington and about four other places services were held on holy days, Wednesdays and Fridays.⁸⁸ In most churches the holy communion was administered thrice, or at most four times yearly⁸⁹; in this respect also Caddington was an exception, for here there were celebrations eight times a year, on Christmas Day and the Sunday following, on Easter Day, Low Sunday, Whit Sunday, Trinity Sunday, 'Ordination Sunday in September,' and the Sunday after it.⁹⁰ Both at Wheathampstead and Ardeley there were seven celebrations, and at Stevenage eight or nine. At Harpenden, Hertford and Hitchin the holy communion was administered monthly and on the three great festivals, at Hertingfordbury and Tewin monthly, and at Hemel Hempstead fourteen times in the year.⁹¹

The next fifty years brought little alteration in the number of services. A return made for 1763⁹² shows that morning and evening prayer was still confined to Sundays, that the Eucharist was still celebrated thrice or at most four times yearly,⁹³ and this remained the standard for the next half-century at least.⁹⁴

Hertfordshire was singularly little touched by the revivals of the late 18th and early 19th centuries; their influence was almost entirely mediate. The most obvious result of the Evangelical movement was the establishment of chapels of the Countess of Huntingdon's Connexion at Whitwell and elsewhere. By the second decade of the 19th century the new spirit had permeated everywhere and was making itself felt in both the ornaments and administration of the Church. Thus in 1820 St. Peter's, Berkhamstead, was restored, the outside stuccoed, the ceilings plastered, and a gallery erected at the west end.⁹⁵ Six years later was made the first attempt at the subdivision of parishes since the time of the Commonwealth, and the district

⁸⁴ Preserved in the Alnwick Tower, Lincoln.

⁸⁵ Bp. Gibson's Visit. (Linc. Dioc.), 1717-47 (Lib. of D. and C. of St. Paul's).

⁸⁶ At Wigginton and Long Marston service was only said once a month (Salmon, *Herts.* 128, 133). This was evidently exceptional. In 1706 the Bishop of Lincoln had desired incumbents to read public prayers, if they could get a congregation together, every day, at least on Wednesdays, Fridays, Sundays, holy days and their eves (*Bishop of Lincoln's Charge . . . in his Primary Visitation, 1706*).⁸⁷ *Visit. cit.*

⁸⁷ *Ibid.*; 'Speculum Dioecesis.' Prayer on Wednesdays and Fridays was enjoined in 1550 (*Injunctions given in the Visit. of . . . Nycolas bysheppe of London*) and 1559 (*Injunctions given by the Quenes Maiestie*). The saying of the Litany on these days was presupposed by the *Articles to be enquired of within the Archd. of Middlesex, 1662*.

⁸⁸ There were four celebrations only at Knebworth in 1605, i.e. at Christmas, Easter, Whit Sunday and Michaelmas (Jones MS. [Dr. Williams's Lib.], B 21). For services at Shephall see *ibid.* B 16.

⁸⁹ Bp. Gibson's Visit. *ut supra*.

⁹⁰ 'Speculum Dioecesis.'

⁹¹ This must have been compiled from the answers to the visitation articles put forward by Bishop Osbaldeston in his primary visitation of this year, see Jones MS. B 16, no. 149.

⁹² Guildhall MS. 481. Among the 'duties of a parish priest,' as described by Jones (Jones MS. [Dr. Williams's Lib.], A 39), was 'to explain the duty and press the necessity of frequent Communions; and to endeavour to introduce the practice thereof.' A very interesting account of the services at Stevenage and Shephall in 1763 and 1766 will be found in Jones MS. B 16. Here, too, is a list of ornaments necessary for the decent conduct of the communion service, but missing at Shephall.

⁹³ Bishop Porteus complained that in many places service was held on Sunday once only. He enjoined one sermon and prayers twice in the day (*Charge to the Clergy of the Diocese of London, 1792*, pp. 13-14).

⁹⁴ Cussans, *Hist. of Herts. Ducorum Hund.* 57.

ECCLESIASTICAL HISTORY

of St. Peter's, Colney, was formed from St. Peter's and St. Stephen's in St. Albans and Shenley.⁹⁶ The Oxford Movement proper had no notable adherents here, and it was not until about 1860 that its effect began to be felt. What this was on the fabric of the churches can be judged from a comparison of the plates inserted in the county histories of Clutterbuck (1815) and Cussans (1879-81). A wave of restoration passed over the county. In 1862 Tring Church was being renovated, while Harpenden was being rebuilt, these being the first churches affected; in 1879 only three of the eighteen parishes in the hundred of Dacorum were unrestored.⁹⁷ At the same time services were being increased, and monthly celebrations became general. The readjustment of parishes had been begun some time before; seven new parishes were formed between 1840 and 1850, ten between 1850 and 1860, eight between 1860 and 1870, and eight in the next ten years. Only one new parish was formed in 1880-90 and four in 1890-1900. Since the opening of the 20th century twelve parishes have been constituted, special attention being paid to the needs of Watford with its growing industrial population.⁹⁸

With the passing of the Act of Uniformity and the consequent ejection of nonconforming clergy separatist congregations came into being all over the country. The bitter feud between Independents and Presbyterians must, of course, have resulted in local meetings even before this date when a member of the rival party was in possession of the parish church, but organized Dissent must be dated from 1662.⁹⁹ It is known that ejected clergy set up conventicles at Watton at Stone, Hertford, Hitchin, Bishop's Stortford, Minsden (in Hitchin), Rickmansworth, Bovington, Theobalds and Kimpton¹⁰⁰; the majority of these were of Independents, for the Parliamentary appointments to Hertfordshire churches had been markedly Independent in character. From 1662 to 1672 meetings such as these were, of course, illegal. Under the statute of 1593 any person of over sixteen years of age who absented himself from church, persuaded any other person to abstain, or was present at a conventicle was liable to imprisonment till he conformed; if he failed to conform within three months of conviction his goods were declared forfeit and the offender was to abjure the realm.¹ This Act had fallen into disuse during the period of divers opinions under the Commonwealth, but was revived in 1664 as the Conventicle Act. Nonconformists were also liable under the Acts specially framed against Roman Catholics in the time of Elizabeth; by these any person of over sixteen convicted of non-attendance at church was liable to a fine of £20 for every month of absence, or to forfeit two-thirds of his lands.² Except in the case of Quakers and Roman Catholics these laws do not seem to have been generally enforced. On the whole, there was very little disturbance, though a certain amount of vexation of ministers.³ The story of the funeral service held in the abbey church

⁹⁶ *St. Albans Dioc. Cal.* 1912, p. 88. It was not, however, legally constituted until 1909.

⁹⁷ Cussans, *op. cit. passim.*

⁹⁸ *St. Albans Dioc. Cal.* 1912.

⁹⁹ In April 1633 James Pope of Hemel Hempstead stood excommunicate for keeping conventicles at the house of Michael Suett (S. P. Dom. Chas. I, ccclxxxvii, 68).

¹⁰⁰ Calamy, *Nonconformists' Mem.* (1802), ii, *passim.*

¹ Stat. 35 Eliz. cap. 1.

² *Ibid.* 23 Eliz. cap. 1; 29 Eliz. cap. 6; 3 Jas. I, cap. 4.

³ cf. Calamy, *op. cit.* ii, *passim*; *Quarter Sess. R.* (Herts. Co. Rec.), i, *passim.* Many laymen, however, were presented in the ecclesiastical courts for failing to attend the services at the parish church (Urwick. *op. cit.* 187, &c.).

A HISTORY OF HERTFORDSHIRE

of St. Albans in May 1662 by the ejected William Haworth and interrupted by the soldiery with fatal result aroused indignation which could only be expressed for an exceptional occurrence.⁴

Conventicles of the Independent persuasion were reported in 1669 as being held at St. Albans, Sawbridgeworth, Rickmansworth and St. Paul's Walden, but the preachers mentioned were undistinguished, and indeed some of the most notable of the ejected had either died or left the county.⁵ One of the licences⁶ granted to Independents in 1672 under the Declaration of Indulgence was to an ejected minister. Nathaniel Eeles remained at Harpenden after his ejection from that curacy until the passing of the Five Mile Act,⁷ when he himself moved to Bovington, leaving his wife and children at their old home. In 1672 he obtained a licence for his house at Harpenden,⁸ and with the help of an assistant preached there and at Codicote until his death in 1678.⁹

From this time organized Nonconformity became a recognized fact, though its legality was not ensured until 1688-9, when the Toleration Act suspended the prosecuting laws in cases where Nonconformists attended an assembly certified under the Act and took the oaths of supremacy and allegiance.¹⁰

A return of 1715 speaks of Independent congregations at Bendish, Bishop's Stortford, Barnet, Cheshunt, Hertford, Hitchin, Royston and Theobalds; that at Bishop's Stortford was said to have a congregation of 600 persons.¹¹ Dissent had by this time a firm hold on the county, and the Bishop of Lincoln noted¹² that among the parishes under his care William¹³ and Digswell alone were unaffected. At Harpenden there were 130 Dissenters, at Hertingfordbury about a quarter of its eighty-nine families, at Totteridge fifty out of a hundred did not conform, while at Walkern were eighty-four Dissenting families.¹⁴

Congregationalism continued to hold its own in the county, and between 1852 and 1884 no less than twenty-three new chapels were registered as belonging to Congregational or Independent bodies.¹⁵

Presbyterianism, with its uncompromising discipline, had never been popular in Hertfordshire. The most distinguished leader in the county was undoubtedly Edmund Staunton, some time rector of Bushey, and from 1648 to the Restoration President of Corpus Christi College, Oxford.¹⁶ On his ejection from Oxford in 1660 he settled at Rickmansworth, receiving there

⁴ See Calamy, op. cit. ii, 300; Urwick, op. cit. 174-8.

⁵ Turner, *Orig. Rec. of Early Nonconf.* i, 92; Urwick, op. cit. *passim*. e.g. Isaac Bedford, late vicar of William, died in 1667 (Calamy, op. cit. ii, 315), Jeremiah Burwell, late vicar of St. Andrew's, Hertford, in 1668 (*ibid.* 308); Nathaniel Ball, late vicar of Royston, had settled in Essex (*ibid.* 311).

⁶ The rest were to Mr. Jonathan Pitman's house in Theobalds; Mr. Hill's house in Aybrook (Crossbrook) Street, Chesham (Cheshunt); the house of Mr. Cusors (? Ewers) at Ponsbourne; the house of Widow Heath at Preston; Mr. Thomas Polhill's house at 'Chesham' (Turner, *Orig. Rec. of Early Nonconf.* i, 284, 304); the house of Thomas Morrice at Ashwell (*ibid.* 319); the house of Sarah Adams at Hitchin, of William Eeles at Flamstead, of — Cox at Hertford, of John Wheeler at Royston and of Robert Pemberton at St. Albans (Bate, *Declaration of Indulgence*, App. vii. pp. xxxi, lxix).

⁷ Stat. 17 Chas. II, cap. 2.

⁸ *Cal. S. P. Dom.* 1672, p. 237.

⁹ Urwick, op. cit. 419-20.

¹⁰ Stat. 1 Will. and Mary, cap. 18. Cases still occurred of prosecutions for absence from church or any other place of public worship (*Quarter Sess. R.* [Hert. Co. Rec.], ii, 24, 30), and schoolmasters teaching 'grammar' were still required to produce episcopal licence (Visit. 1715 [Lond. Epis. Reg.]).

¹¹ Add. MS. 32057, fol. 8b.

¹² 'Speculum Dioecesis' (Alnwick Tower, Linc.).

¹³ But in January 1714-15 licence was applied for for the house of John Needham here as a place of worship for Protestant Dissenters (Urwick, op. cit. 629).

¹⁴ 'Speculum Dioecesis' (Alnwick Tower, Linc.).

¹⁵ Urwick, op. cit. 854-7.

¹⁶ Mayo, *Life and Death of Edmund Staunton*, 16.

ECCLESIASTICAL HISTORY

‘ a very kind welcome, both from the gentry, as a gentleman, and other good Christians of inferior rank, as a minister of Jesus Christ.’¹⁷ He preached publicly there and elsewhere, apparently in the parish churches, until 1662, when ‘ his wife now labouring under some weaknesses, and being weary with the burden of household affairs, he retired to a chamber or two in a private Family some miles distant. . . As long as he lived there, there was a church always in that house.’¹⁸ He afterwards moved to the neighbourhood of St. Albans, and later to Bovingdon, being ‘ led thither by the invitation of a religious and very kind Gentleman, freely accommodating him, with all the conveniences of an habitation of his in that place.’¹⁹ ‘ Seeing he could not preach in a church to many, he would preach in a chamber to a few,’²⁰ and Bovingdon became the centre of a work which extended through all the villages about. A regular meeting was established before 1669 at the house of a Mrs. Bachelor in ‘ the Abbey parish ’ of St. Albans, and here Staunton, William Jenkyn of King’s Langley,²¹ and Isaac Loeffs, late rector of Shenley, preached Sunday by Sunday to a congregation of a hundred persons.²² Staunton and Loeffs also preached regularly at Codicote, where there was a meeting of a similar size.²³ At Ridge conventicles were held at the house of John Clarke, gentleman, and of John Nicholls, a rich yeoman, and the Presbyterians had the support of Mr. Lomax, an attorney. Here, too, the preachers were Staunton and Loeffs.²⁴ At Theobalds in the parish of Cheshunt there was a congregation whose ministers were Thomas Wadsworth and a Mr. Bragge.²⁵ Staunton died in 1671,²⁶ and it may be that with his death the congregations at Codicote and Ridge dispersed, for no licence was asked for either of these places under the Declaration of Indulgence in the following year. When driven away from Acton in 1669 Richard Baxter and his wife settled at Totteridge, where they lived until 1672, and here he preached in his own house.²⁷ It was in Hertfordshire in 1676 that Baxter first preached publicly after his ejection. He had still an old licence of the bishop and preached first at Rickmansworth and after that at the churches of Sarratt, of King’s Langley, and of various places in Buckinghamshire.²⁸ While at Rickmansworth he had a great discussion with William Penn, the Quaker, and they ‘ continued speaking to Two Rooms full of People (Fasting) from Ten a Clock till Five (One Lord and Two Knights, and Four Conformable Ministers, besides others, being present, some all the Time and some part),’ for ‘ the neighbourhood of Rickmansworth abounded with Quakers.’²⁹ Presbyterianism, indeed, at this time seems to have been chiefly in the east and in the extreme south of the county with the exceptions of St. Paul’s Walden and Ashwell.³⁰ Licences were issued for meeting-houses at Bishop’s Stortford, Sawbridgeworth, and Little Hadham in the east, and at Watford, Garston, Chipping Barnet, Little Berkhamstead and Abbot’s Langley in the south.³¹ Only two Presbyterian congregations—at St. Albans and ‘ Bloxam ’ (? Broxbourne)—are mentioned in the return of 1715,³² and

¹⁷ Mayo, *Life and Death of Edmund Staunton*, 19.

¹⁸ *Ibid.* 22.

¹⁹ *Ibid.* 23.

²⁰ *Ibid.* 25.

²¹ He had been ejected from Christ Church, Newgate Street, London, in 1662 (Hennessy, *Novum Repert.* 126).

²² Turner, *Orig. Rec. of Early Nonconf.* i, 92.

²³ *Ibid.* 93.

²⁴ *Ibid.* 94.

²⁵ *Ibid.* 95 ; Urwick, *op. cit.* 509.

²⁶ Salmon, *op. cit.* 117.

²⁷ *Reliquiae Baxterianae* (ed. Sylvester), pt. iii, 60, 103.

²⁸ *Ibid.* 174.

²⁹ *Ibid.*

³⁰ Turner, *Orig. Rec. of Early Nonconf.* i, 215.

³¹ Bate, *Declaration of Indulgence*, App. vii, p. xxxi.

³² Add. MS.32057, fol. 8b.

A HISTORY OF HERTFORDSHIRE

the report made for the Bishop of Lincoln two years later shows Presbyterian families scattered here and there over the Hertfordshire parishes of the arch-deaconry of Huntingdon, but in considerable numbers only at Cottered.³³ The anti-Trinitarian tendency discernible in many Presbyterian congregations began to make itself markedly felt at about this time, but it seems probable that many of the Hertfordshire followers ultimately joined the Congregationalists. The most important secession of this kind was that of the congregation at Theobalds, numbering 300 persons in 1715. In 1733 these formally united with the members of the Congregational chapel at Crossbrook, Cheshunt.³⁴ By 1825 the only remaining Presbyterian congregation was that which met in the chapel in Lower Dagnall Street, St. Albans.³⁵ The teaching was 'distinctly Socinian,'³⁶ and the chapel finally became definitely Unitarian. Dr. James Martineau was associated with it and had much influence in the town. After 1868, however, there was no regular minister here; the congregation gradually dispersed, and finally the chapel, built in 1690, was sold in 1895 by order of the Charity Commissioners, the proceeds being added to the funds of the Provincial Assembly of London and the South-Eastern Counties.³⁷

From the earliest days of the Reformation infant baptism had proved a dividing point among Protestants. From the beginning of the 17th century entries in the parish registers up and down the county seem to show a dislike to the ordinance, and presentments in the archidiaconal courts of neglect to have children baptized were not infrequent.³⁸ Bitterly as the ruling parties in the Commons, the Independents and Presbyterians, opposed the Baptists, it was owing to the direct influence of the House of Commons that George Kendall, one of their most distinguished ministers, obtained a footing in Hertfordshire. In 1642 the House of Commons settled Kendall as lecturer at Hemel Hempstead.³⁹ On complaints that Kendall refused infants baptism⁴⁰ Dr. Burgess was sent down to inquire and report.⁴¹ The result was that Kendall was lodged in Newgate during the pleasure of the House.⁴² Other notable Baptists at this time were Edward Harrison, vicar of Kensworth, and Daniel Dyke,⁴³ rector of Much Hadham; pronounced views, Antinomian as well as Baptist, were also held by Robert Baldwin, who was committed to the prison of the Gate House in Westminster.⁴⁴ In 1653 the Council of State had declared itself satisfied 'concerning the gifts and abilities of Major William Packer to preach the gospel,' and had described him as eminent in godliness.⁴⁵ Fox tells how 'Coll: Packer had gotten Tybballs and was made a Justice of peace there: and there sett upp a great meetinge of ye baptists in Tybballs parke.'⁴⁶ Here in March 1657-8 a congregation was

³³ 'Speculum Dioecesis' (Alnwick Tower, Linc.).

³⁴ Urwick, *op. cit.* 513.

³⁵ *The Manchester Socinian Controversy*, 132.

³⁶ *Ibid.*

³⁷ George E. Evans, *Vestiges of Protestant Dissent*, 245 and n. ³⁸ See Urwick, *Nonconformity in Herts. passim.*

³⁹ *Ibid.* 209; *Commons' Journ.* ii, 730.

⁴⁰ *Lords' Journ.* vi, 433, 446, 470.

⁴¹ *Ibid.* 4-0; Lightfoot, *Works*, xiii, 186.

⁴² *Lords' Journ.* vi, 470, 480, 500.

⁴³ Crosby, *Hist. of the Baptists*, ii, 57; iv, 25. Dyke was grandson of William Dyke of St. Michael's (Urwick, *op. cit.* 211, see above, pp. 328-9). Calamy (*Nonconformists' Mem.* [1802], ii, 304) says that Dyke and Tombes were probably the only Baptists among the Triclers of 1653.

⁴⁴ *Lords' Journ.* vi, 470, 681.

⁴⁵ *Cal. S. P. Dom.* 1653-4, p. 13.

⁴⁶ Fox, *Journ.* (ed. 1911), i, 165. 'They were exceedinge high and railed against freindes and truth and threatned to apprehend mee with there warrants if ever I came downe there: I was moved of ye Lord God to goe down to Tiballs and appointe a meetinge harde by,' but Packer 'had not power to medle with mee' (*ibid.* and 166).

ECCLESIASTICAL HISTORY

under the ministry of John Spencer,⁴⁷ probably that 'Captain Spencer' who according to the report of 1669 was preacher to a Hertford 'meeting of Anabaptists to the number of 400 and upward.'⁴⁸ The report, which is obviously incomplete, further mentions conventicles at St. Albans where the congregation of fifty persons met occasionally at various places, at Watford, where 'some of considerable estates' were among those who met at the house of John Crawley, a joiner, and at Redbourn.⁴⁹ These conventicles were, of course, illicit, and that at Redbourn seems to have disappeared shortly afterwards.⁵⁰ The return, however, makes no mention of the meeting at Pirton, for which the house of Thomas Carter was licensed in 1672, the licensed teachers being Robert Collinson, Thomas Silby and Thomas Vaux.⁵¹ A return of 1715 reports Baptists at St. Albans, Bishop's Stortford, Barnet, Berkhamstead, Codicote and Rushden, Hitchin, 'King's North' near Hemel Hempstead, Marlowes, Markyate Street, Tring, Theobalds, Ware and Watford,⁵² and shortly afterwards a conventicle was noted at Wheathampstead.⁵³ Within the next ten years further meetings had been formed at 'Bedenham,' 'Pond' and Coney Street and Braughing.⁵⁴

The congregation which had met for many years under the protection of the Joscelins⁵⁵ of Hyde Hall, Sawbridgeworth, had dispersed 'a considerable number of years' before 1772,⁵⁶ and most of the congregations mentioned in 1715-17 seem to have come to an end at an early date, the only survivors in the 19th century being those at Barnet, Berkhamstead and Tring.⁵⁷ The church at Tring joined the New Connexion in 1801,⁵⁸ as did the church of Berkhamstead in 1809⁵⁹; the latter is now, however, a member of the Baptist Union.⁶⁰

The history of Wesleyanism in Hertfordshire is somewhat curious. It was not until some twenty years after the establishment of the society that John Wesley visited Hertford. He had evidently heard that the place would offer him little encouragement, though his meeting was undisturbed; at the close of it he wrote that he doubted not but 'much good may be done even here.'⁶¹ His subsequent visits had some effect, but before December 1772 'the servants of God quarrelled among themselves till they destroyed the whole work,' even preaching being discontinued.⁶² Wesley was bitterly disappointed, and never afterwards mentioned the town without commiseration.⁶³ In 1775 and twice in 1778⁶⁴ he was back preaching at 'poor desolate Hertford,' and on one occasion he added that 'they heard me with something like seriousness.'⁶⁵ He also preached at Barnet, where he had in the evening 'a larger congregation than ever, and a greater number of communicants.' Encouraged by such results he asked 'Will this poor barren wilderness at length blossom and bud as the rose?'⁶⁶ Wesley's forebodings

⁴⁷ Urwick, op. cit. 507.

⁴⁸ Turner, *Orig. Rec. of Early Nonconf.* i, 84.

⁴⁹ *Ibid.* 92-3.

⁵⁰ The two Baptist congregations established here by 1884 were of modern growth (Urwick, op. cit. 301-2).

⁵¹ Bate, op. cit. App. vii, p. xxxi. ⁵² Add. MS. 32057, fol. 8b. ⁵³ 'Speculum Dioecesis' (Alnwick Tower, Linc.)

⁵⁴ T. S. James, *Hist. of the Litigation and Legislation respecting Presbyterian Chapels and Chantries*, 663.

⁵⁵ Carter had lived with Sir Robert Joscelin after his ejection from the rectory of Graveley (Calamy. *Nonconformists' Mem.* [1802], ii, 304).

⁵⁶ Urwick, op. cit. 687, quoting Josiah Thompson's MSS. (Dr. Williams's Lib.).

⁵⁷ *Minutes of the General Assembly* (Baptist Hist. Soc.), i, p. lix. For Barnet cf. *ibid.* ii, 37, 48.

⁵⁸ *Ibid.* i, p. lix. ⁵⁹ *Ibid.* 36 n. ⁶⁰ *Ibid.* ii, 332. ⁶¹ *Journ.* (ed. F. W. Macdonald), iii, 153.

⁶² *Ibid.* 494 (18 Dec. 1772). ⁶³ *Ibid.* iv, 39 (13 Jan. 1775).

⁶⁴ *Ibid.* 115, 143 (9 Nov., 30 Oct. 1778). ⁶⁵ *Ibid.* 143 (30 Oct. 1778). ⁶⁶ *Ibid.* 115 (9 Nov. 1778).

A HISTORY OF HERTFORDSHIRE

were evidently fulfilled. No circuit was formed for the county until 1824, when that at St. Albans became part of the Second London District,⁶⁷ the minister changing once every month with the preachers at Luton.⁶⁸ In 1825 the congregation numbered 145,⁶⁹ and 192 in 1830⁷⁰; the minister was to live at Watford.⁷¹ The Watford congregation dated from 1808, its first chapel in Water Lane being built six years later.⁷² It became a circuit town in 1869.⁷³ New Barnet attained that status at a still later date. New Barnet, Watford and St. Albans are now the heads of circuits in the First London District, the sixth circuit of which is known as that of London (Hertfordshire Missions).⁷⁴

Great as were the hardships encountered by members of all the non-conforming bodies in the 17th century, none can equal the sufferings of those who belonged to the Society of Friends. Though Fox visited Hertfordshire soon after his conversion,⁷⁵ he does not seem to have imparted his peculiar tenets to any at that time, and no mention of Quakers in the county has been found before 1656.⁷⁶ By this time the distinctive features of their belief had fully developed. The Quaker held that there was no warrant from Scripture for a paid ministry, that tithes were without justification, that sacraments were unnecessary. Doctrine such as this earned for them the hatred and execration of all the other sects, while the civil authorities looked with distrust on a body which asserted the sinfulness of oaths, the unmeaningness of rank and the unlawfulness of resistance in any shape or form. The principles of the Friends, indeed, cut at the root of all that both Royalist and Parliamentary held most essential to the administration of Church and State.

In 1704 Henry Sweeting, who must then have been an old man, declared that 'the first Publick friend that came into Hertford' was James Naylor. He lodged with Sweeting, and at a meeting in his house his host and hostess with their two daughters were convinced.⁷⁷ This must have been before 1658, when Nicholas Lucas of Ware was imprisoned for seven months for non-payment of 3s. tithe.⁷⁸ Henry Stout of Ware was also imprisoned in this year,⁷⁹ and it seems probable that a meeting there was already in existence. The Quakers were especially strong at this time in the east of the county, and seem to have roused the popular hatred,⁸⁰ for in 1659 the rabble broke up meetings at 'Standborne' (? Standon) and Sawbridgeworth.⁸¹ It would seem that at the latter place the Quakers already had a meeting-house, for the report describes how the mob after 'striking them as they came thither, throwing them off their Horses, and Wallowing them in the Mire, daubing their Faces and Clothes, filling their Hats with Dirt, and so putting them on their Heads,' then broke down the tiles, boards, windows and walls of the meeting-house. The assault continued for the three hours the meeting lasted.⁸² In 1660 the authorities broke up

⁶⁷ *Minutes of the Methodist Conferences*, v, 476.

⁷⁰ *Ibid.* 580.

⁷¹ *Ibid.* 560.

⁶⁸ *Ibid.* vi, 16.

⁷² Urwick, *op. cit.* 363-4.

⁶⁹ *Ibid.* 38.

⁷³ *Ibid.* 364.

⁷⁴ *Wesleyan Methodist Church: Names and Addresses of Circuit Stewards*, 1912.

⁷⁵ *Journ.* (ed. 1901), 1, 3.

⁷⁶ Besse, *A Coll. of the Sufferings of the People called Quakers*, i, 240.

⁷⁷ *The First Publishers of Truth* (Friends' Hist. Soc.), 342.

⁷⁸ Besse, *op. cit.* i, 241.

⁷⁹ *Ibid.*

⁸⁰ Perhaps owing to their 'testimonies.' Henry Fest and Thomas Harris would seem to have 'borne testimony' in 1658, for both were convicted of having disturbed ministers (*Extracts from State Papers relating to Friends* [Friends' Hist. Soc. Ser. 1]), 52.

⁸¹ Besse, *op. cit.* i, 241.

⁸² *Ibid.*

ECCLESIASTICAL HISTORY

meetings at Baldock, Royston, Hitchin, Hertford and Ware,⁸³ but these measures were entirely futile. Pepys when riding north in the following year describes how he 'got to Baldwick' (Baldock), and how he found that both there and everywhere else that he came 'the Quakers do still continue, and rather grow than lessen.'⁸⁴ The Quaker Act,⁸⁵ which became law in May 1662, made it penal for five or more persons of over sixteen years of age to assemble at one place or time for unauthorized worship. On conviction, confession or notorious evidence of the fact the offender was liable, for the first and second offences, to fines not exceeding £5 and £10 respectively, and for the third to transportation with the alternative of abjuring the realm. Twenty-four persons were tried under this Act at the Midsummer sessions of this same year.⁸⁶ In 1663 meetings were discovered at King's Langley and at Widford.⁸⁷ At Hertford divers of the Quakers were 'men of estates and repute,'⁸⁸ and there seems to have been some reluctance at prosecuting them. According to a report made in 1664 'the Sectaries are said to grow so numerous there out of y^e dislike and prejudices they have taken up against one of y^e vicars of Hartford,⁸⁹ who hath very fewe auditors.' It was suggested that if two or three clergymen of parts and temper could convince the Quakers it would be instrumental to the undeceiving of the rest of the sectaries 'in this chrisis of time' before the new Conventicle Act came into force on 1 July 1664.⁹⁰ The Act was straightway put in force, and on 12 August Henry Feast and eight others were indicted for the third offence under the Conventicle Act.⁹¹ The witnesses for the prosecution agreed that while they had found the Quakers assembled 'they neither heard any of them speak, nor saw them do anything.' The Grand Jury returned a bill of 'ignoramus,' but the judge, Orlando Bridgman, sent them back with fresh instructions and they finally returned a true bill; one of the prisoners was found not guilty, the rest were sentenced to transportation to the Barbadoes and Jamaica.⁹² Meetings seem, however, still to have been held at the house of Nicholas Lucas at Hertford, and three men and four women were indicted at the quarter session for having been present.⁹³ Five of them stood mute and were sentenced to the Barbadoes.⁹⁴ In October twenty-one Quakers were sentenced to transportation.⁹⁵ The meetings still persisted, however,⁹⁶ and in 1669 it was reported that a public meeting was held every Sunday at Hertford at a room specially fitted up for the purpose.

⁸³ Besse, op. cit. i, 241-2.

⁸⁴ *Diary*, 6 Aug. 1661. On 2 Aug. he had ridden to Ware, 'on the way having much discourse with a fell-monger, a Quaker, who told me what a wicked man he had been all his life-time till within two years.'

⁸⁵ Stat. 13 & 14 Chas. II, cap. 1.

⁸⁶ Besse, op. cit. i, 243.

⁸⁷ *Ibid.* 244; cf. *Quarter Sess. R.* (Herts. Co. Rec.), i, 153.

⁸⁸ *Extract from State Papers* (Friends' Hist. Soc. Ser. 2), 192.

⁸⁹ Thomas Ashton, vicar of St. Andrew's, instituted 20 Dec. 1660 (Urwick, op. cit. 532 n.). For the scandals connected with him see Turner, *Orig. Rec. of Early Nonconf.* i, 84-5; Ralph Wallis, *Room for the Cobler of Gloucester* (1668), 17-18.

⁹⁰ *Extracts from State Papers*, loc. cit.; Stat. 16 Chas. II, cap. 4.

⁹¹ Besse, op. cit. i, 244; cf. Urwick, op. cit. 533-5 and n.

⁹² *Ibid.*, where their adventures are related in detail; cf. *Quarter Sess. R.* (Herts. Co. Rec.), i, 164.

⁹³ *Quarter Sess. R.* (Herts. Co. Rec.), i, 162. Margaret Bevis was wife of Thomas Bevis, gent., whose children were registered as born (not baptized) in 1647, 1649 and 1652 (Urwick, op. cit. 532). She was fined £20 with an alternative of prison for six months.

⁹⁴ *Quarter Sess. R.* (Herts. Co. Rec.), i, 166.

⁹⁵ Besse, op. cit. i, 248.

⁹⁶ *Quarter Sess. R.* (Herts. Co. Rec.), i, 176. Nicholas Lucas was a maltster. He lay in Hertford Gaol under sentence of transportation from 1664 to 1672, and afterwards became one of the proprietors of West Jersey (*Friends' Hist. Soc. Journ.* vii, 43).

A HISTORY OF HERTFORDSHIRE

It was attended by a great number and was dominated by a Captain Crook, 'a Justice of the Peace under Cromwell . . . of dangerous principles, a subtle fellow and one who hath too much influence upon the people of that Town and the country about.'⁹⁷ A meeting was also said to be held every Sunday and Wednesday at a house hired for the purpose at St. Albans,⁹⁸ and at this Crook also attended. At Redbourn meetings were held in the houses of William Barber, gent., and Thomas Bigge, yeoman, and were sometimes attended by 200 or 300 persons. Crook had also followers at Norton, and at Shephall a small meeting was held at the house of Daniel Mardell, a smith.⁹⁹ At about this time there were seventeen 'established and settled meetings within the County of Hertford of the People of God there,'¹⁰⁰ and comparatively few of these seem to have been disturbed.¹ Public opinion, indeed, seems to have been against the persecution,² and when the Quaker Act was renewed in 1670 the penalties of transportation and imprisonment were superseded by fines.³

Owing to the peculiar tenets of the Quakers they were liable to be charged under a number of Acts for offences not strictly ecclesiastical in character, as well as for non-attendance at the parish church. The charge most commonly brought forward was under the statutes which made it an offence punishable as *praemunire* for any person over the age of eighteen to refuse to take the oath of allegiance.⁴ The Restoration was followed by a number of prosecutions under this Act, as many as nine Quakers being sent to gaol on one day for refusing the oath.⁵ If a prosecution under another Act failed it was no uncommon thing for the justices to tender the oath which the Quaker's principles made it impossible for him to take.⁶ In this way Henry Sweeting and three other Hertford men were outlawed in 1662; they were, however, sent back to Hertford Gaol, but after thirty-one weeks' imprisonment they obtained a royal pardon.⁷ The Toleration Act provided that those who scrupled to take the oath of allegiance should subscribe to its terms,⁸ and from this time the collection of tithes alone gave an opening for the vexing of the Quaker. From the first the objection to the payment of tithes and church dues had been one of the most difficult of the Friends' principles to reconcile with law and custom. The trial of one who refused payment lay in the ecclesiastical courts, and under a Tudor statute⁹ the judge

⁹⁷ Turner, *Orig. Rec. of Early Nonconformity*, i, 84-5. Crook died at Hertford in 1699, aged eighty-one (Urwic, op. cit. 536).

⁹⁸ The Quaker burial-ground still exists in Victoria Street, St. Albans.

⁹⁹ Turner, op. cit. i, 92.

¹⁰⁰ *Friends' Hist. Soc. J. Ann.* viii, 111. They were: 1. Hertford; 2. Ware; 3. Widford, Sawbridgeworth, Hertford; 4. Royston; 5. Rushden (Ryston), Sandon, Cottered and Buntingford; 6. Ashwell; 7. Baldock; 8. Hitchin; 9. Shephall and Stevenage, Langley, Rabble Heath 'in Stevenage Welling parish'; 10. Sacombe; 11. 'Bendick,' Lilley; 12. St. Albans; 13. 'Sepside'; 14. Cheshunt, Broxbourne; 15. Markyate Street, Redbourn, Gaddesden; 16. Northchurch, Tring; 17. Hoddesdon. The list is from the earliest Quarterly Meeting Minute Book, but the exact date is unknown.

¹ Meetings were disturbed at Baldock in 1670 (Besse, op. cit. i, 249), at Hitchin, at Sawbridgeworth and Widford in 1672 (ibid.), at Royston and Buntingford in 1674 (ibid. 250).

² cf. ibid. 249, 251, 253; *Quarter Sess. R.* (Herts. Co. Rec.), i, 250.

³ Stat. 22 Cha. II, cap. 1.

⁴ Stat. 5 Eliz. cap. 1; 7 Jas. I, cap. 6; cf. ibid. 16 Ric. II, cap. 5. The oath was to be tendered by two justices; if refused the offender was to be committed to gaol until the next assizes. If refused at the assizes, *praemunire*, i.e. outlawry, was incurred.

⁵ Besse, op. cit. i, 242.

⁶ For gossip on this point see Pepys, *Diary*, 4 Apr. 1668.

⁷ Besse, op. cit. i, 243-4; *Extracts from State Papers* (Friends' Hist. Soc. Ser. 2), 165. For another pardon by Charles II see Besse, op. cit. i, 244.

⁸ Stat. 1 Will. and Mary, cap. 18.

⁹ Ibid. 2 & 3 Edw. VI, cap. 13.

ECCLESIASTICAL HISTORY

might excommunicate the offender, and after a lapse of forty days might sue a process of *de excommunicato capiendo* from the temporal courts; a further statute¹⁰ enabled the offender to be imprisoned until he rendered obedience. Innumerable cases of this nature were tried¹¹ and great hardships inflicted, Quakers being imprisoned for neglect to pay tithe as late as 1690,¹² for the Toleration Act had not touched the point. In 1696, however, it was enacted¹³ that two justices might ascertain the amount due and might obtain it by distraint. From this time prosecutions ceased, and in the 18th century the Quaker frequently came to a friendly understanding with the parson by which distress was levied in the least inconvenient way possible.

With the 18th century begin the extant records¹⁴ of the Hertfordshire meetings. The society seems to have been spreading at this date, and in 1704 there was a monthly meeting at Watford.¹⁵ A request for the licence of a dwelling-house for worship at Watton at Stone was made in 1707,¹⁶ and in 1710 a similar request was made for the house of John Kilbey at Ickleford.¹⁷ Three years later Samuel Peet sought a licence for his barn at Graveley,¹⁸ and in 1719 the Friends at Hemel Hempstead had newly erected a meeting-house on land behind the Bell Inn.¹⁹ The Quakers had been strong here for some time past, and a school was kept by John Owen, a Quaker,²⁰ who in 1722 was found not guilty of a charge of keeping a private school without episcopal sanction.²¹ A licence was sought for meeting-houses in Crossbrook Street, Cheshunt, in 1726 and near Kilne's Lane, Ware, in 1729.²² Some twelve years before the greater part of the Dissenters in Welwyn were Quakers, but the return²³ then made seems to show that the number of Quaker families had decreased in the past few years.²⁴ In 1785 the Hertfordshire Quarterly Meeting was united with that for Bedfordshire, and so continued until 1865; since then it has been entirely merged in the Bedfordshire Quarterly Meeting. In 1865 the Albans Monthly Meeting ceased to have a separate existence, being merged in that for Leighton and Luton.²⁵

In 1852 meeting-houses were registered in Norton Street, Baldock, Brand Street, Hitchin, Lord's Lane, Hoddesdon, Great Berkhamstead and Kibe's Lane, Ware.²⁶ In addition to these other meetings were established at Hertford and Hemel Hempstead.²⁷ Monthly meetings were held at St. Albans, Hertford and Hitchin, while the quarterly meetings were held at Hertford or Hitchin.²⁸ Towards the close of the 19th century the number of Friends in the county greatly decreased. The migration from London to the home counties has resulted, however, in the establishment of new

¹⁰ Stat. 5 Eliz. cap. 23.

¹¹ Besse, op. cit. i, 241 et seq.; *Quarter Sess. R. passim*.

¹² Besse, op. cit. i, 254.

¹³ Stat. 7 & 8 Will. III, cap. 34.

¹⁴ *Friends' Hist. Soc. Journ.* viii, 108. The records of the Albans Monthly Meeting and the Albans Monthly Meeting of Women Friends date from 1703. In 1688 Mark Swann had been appointed 'to keep the monthly and quarterly meeting books and to record all the things concerning the county' (ibid. ii, 6).

¹⁵ *The First Publishers of Truth* (Friends' Hist. Soc.), 342.

¹⁶ *Quarter Sess. R.* (Herts. Co. Rec.), ii, 38. There was a Quaker meeting here in 1717 ('Speculum Dioecesis' [Alnwick Tower, Linc.]).

¹⁷ *Quarter Sess. R.* (Herts. Co. Rec.), ii, 41.

¹⁸ Ibid. 44.

¹⁹ Ibid. 54. This must have superseded the house licensed in 1699 (Urwick, op. cit. 437). For a list of meeting-houses in 1717-29 see T. S. James, *Presbyterian Chapels and Chantries*, 663.

²⁰ Clutterbuck, op. cit. i, 424.

²¹ *Quarter Sess. R.* (Herts. Co. Rec.), ii, 55. He had been indicted for the same offence in 1720 (ibid.).

²² Ibid. 60, 65.

²³ 'Speculum Dioecesis' (Alnwick Tower, Linc.).

²⁴ Ibid.

²⁵ *Friends' Hist. Soc. Journ.* viii, 108.

²⁶ Urwick, op. cit. 855-7.

²⁷ *An Account of the Times and Places of holding the meetings . . . of the Society of Friends*, 1854.

²⁸ Ibid.

A HISTORY OF HERTFORDSHIRE

meetings at Watford and St. Albans, as well as of a small evening meeting at New Barnet; all these belong to the London and Middlesex Quarterly Meeting.³⁹ There is also a quarterly meeting for Hertford and Hitchin.³⁰

Hertfordshire as a whole seems to have accepted the Reformation with little hesitancy. In 1561 Robert Manners, late parson of Watton at Stone, was the only 'recusant at large but confined within limits' in the county,³¹ while in 1576 Robert Chauncey, gent., was the only person certified as being a fugitive over sea for the sake of religion.³² If a return of the following year may be trusted, there were but five men and two women in the county who followed the old faith, but these were all of gentle birth and within the diocese of London.³³ A month before this report was made the Bishop of London had notified as popish recusants Francis Sellis of Redbourn and the wife of Robert Holmes of Watford, both apparently cottagers, also one Brewster of Ardeley, then in prison in London and owner of land valued at £10.³⁴ The most important recusants were undoubtedly Anthony Throckmorton and his wife, whose lands in Cheshunt were expected to realize £1,000 if sold. At Ware John Chapman and his wife were also well-to-do, but John Maye seems to have been a poorer co-religionist.³⁵ Roman Catholicism was indeed, both then and later, entirely confined to the east of the county, and the Bishop of Lincoln was probably justified in his report that in his visitation this year he could hear of none but such as he 'understood of before,' although he had 'used all the lawfull meanes' he could 'to come to the knowledge of suche persons.'³⁶

Returns such as these have, however, an air of incompleteness, and in 1580 the Privy Council complained to the Bishop of London that the certificates were 'very unperficte,' the names and residences of the recusants not being distinctly set down, while various persons were accused of non-conformity 'because of their lawfull absence' from church.³⁷ Further attempts were made in 1581 to obtain a full list of popish recusants, but apparently without much result.³⁸ The Act of this year³⁹ made attendance at church compulsory on every person over sixteen under a penalty of a fine of £20 monthly or forfeiture to the Crown of two-thirds of the offender's land. The Privy Council ordered quarterly returns of recusants to be made by the churchwardens and sworn-men of each parish to the justices of the peace that indictments might be framed under the Act.⁴⁰ In the archdeaconry of St. Albans the ecclesiastical officials went about the work with great reluctance, and in November 1587 the bishop wrote to the archdeacon that the matter was 'like to come in question before many days' and that serious trouble would follow further evasion.⁴¹ The admonition does not, however, seem to have had much effect, for much the same complaints were made in 1604,⁴² and all the parishes within the archdeaconry declared themselves free of recusants.⁴³ The bishop does not seem to have been satisfied, and in June 1605 the archdeacon wrote to him that there were no recusants 'except only

³⁹ *Religious Society of Friends: Progress in London and the Home Counties*, 1911.

³⁰ *The Friends' Year Book*, 1913.

³¹ *Cal. S. P. Dom.* 1547-65, p. 522.

³² *S. P. Dom. Eliz. cx.* 9. Maurice eldest son of John Chauncey of Ardeley was a monk of the London Charterhouse in 1535. He became prior of the newly-established house of Sheen in 1556 and retired to Flanders on the accession of Elizabeth. He was Prior of the Carthusian convent at Louvain at his death in 1581 (*Dict. Nat. Biog.*). ³³ *Ibid. cxix.* 20. Forty-six persons were returned for Essex, nine for Middlesex.

³⁴ *Ibid. cxviii.* 73.

³⁵ *Ibid.*

³⁶ *Ibid. cxvii.* 13.

³⁷ *Rec. of the Old Archd. of St. Albans*, 12-13.

³⁸ *Ibid. 14, 15, 16.*

³⁹ *Stat. 23 Eliz. cap. 1.*

⁴⁰ *Rec. of the Old Archd. of St. Albans*, 56.

⁴¹ *Ibid.*

⁴² *Ibid. 126.*

⁴³ *Ibid. 128.*

ECCLESIASTICAL HISTORY

within the parish of St. Albans and there none other but such as are become Recusants since his Majesty's reign.' They remained obstinate in spite of the suasion of Mr. Roger Williams, parson there, but all were found 'to carry themselves peaceably not seducing others to our knowledge being persons of mean account and ability.'⁴⁴ There were David East a pewterer, Margaret Smyth, maid-servant to her uncle Leonard Wilkes a haberdasher, Thomas Shepham a weaver, Richard West and his wife, sojourners, and Sarah wife of Richard East.⁴⁵ Christopher Moore was the only recusant in the county who in 1612 desired to be compounded with for the oath of allegiance.⁴⁶

The Recusant Rolls of 1679 show only nine names, those of John Downes, labourer, and John Newport, gentleman, both of Furneux Pelham; of John Belson of Hertingfordbury, Basil More, esq., of North Mimms, William Gawen, gentleman, of Harpenden, and Walter Lord Aston, William Newport, George Parson and Francis Hinde, all of Standon.⁴⁷ The lists of persons charged under the Recusancy Acts in February 1682-3 give names of offenders in Rickmansworth, Berkhamstead, Thundridge, Cottered, Wyddial, Tring, Meesden, Ardeley, Clothall, Ashwell, Hertingfordbury, Flaunden, Little Gaddesden, Barley, Cheshunt, Reed, Royston and Therfield.⁴⁸ At first sight this looks as though Roman Catholicism had spread far and wide over the county; comparison of the names, however, with those of Quakers who are known to have suffered under these Acts leads to the conclusion that the majority of those indicted and fined belonged to the Society of Friends. At the same time known Roman Catholics were fined, and fined time after time.⁴⁹ A congregation seems to have already grown up at Standon, where Walter Lord Aston lived at the Lordship. Father P. Southcote, a Benedictine, lived here from 1705 to 1717, and recusants of the neighbourhood, if known to the family, attended the chapel.⁵⁰ In 1751 the last Lord Aston died and the house was let. It passed into the hands of Bishop Challoner, under whom Father Richard Kendall opened a school there in or about 1753, but moved it to Hare Street four years later.⁵¹ By this time the Church in England had become regularly organized,⁵² and in furtherance of his scheme for providing Roman Catholic education Bishop Talbot in 1771 bought a house at Old Hall Green.⁵³ Father Kendall's students moved here in 1769, and the school, afterwards St. Edmund's College, became the centre of a district which included the whole of Hertfordshire.⁵⁴ In 1780 the 'Standon congregation' was formed by about seventy Roman Catholics from Royston, Buntingford, Puckeridge, Watton, Ware, Stanstead, Standon and Magdalen Laver in Essex.⁵⁵ The mission at Old Hall Green was the only one in Hertfordshire in 1786.⁵⁶ In 1850 the church of Mary Immaculate and St. Gregory the Great was opened at Hertford, and this was followed by that of the Sacred Heart and St. John the Evangelist at Bushey in 1863. Since that date twenty further chapels have

⁴⁴ *Rec. of the Old Archd. of St. Albans*, 131.

⁴⁵ *Ibid.*

⁴⁶ Lansd. MS. 153, fol. 526.

⁴⁷ Exch. L.T.R. Recusant Rolls (Chancellor's Ser.), R. 57. No entries for Hertfordshire occur on Rolls 45-53, 55, 58, 59, 62.

⁴⁸ *Ibid.* R. 60.

⁴⁹ *Ibid.* R. 58.

⁵⁰ Ward, *Hist. of St. Edmund's Chapel*, 21.

⁵¹ *Ibid.* 21, 31, 34; Ward, *The Dawn of the Catholic Revival*, i, 40.

⁵² Ward, *The Dawn of the Catholic Revival*, i, p. xi.

⁵³ Ward, *Hist. of St. Edmund's College*, 35.

⁵⁴ *Ibid.* 39.

⁵⁵ *Ibid.*

⁵⁶ Ward, *The Dawn of the Catholic Revival*, i, 40.

A HISTORY OF HERTFORDSHIRE

been opened, some in connexion with the houses of the various religious orders which have been founded up and down the county.

From the very nature of the case a description of ecclesiastical events, of religious tendencies, must of necessity be unsatisfying and incomplete; so much has been left unrecorded, so much but partially set down. What has come to us is more often the story of failure than of achievement and it is easy to forget how exceptional such cases are and how much is covered by the churchwardens' 'all well.' Behind the struggle of party with party lay ideals and hope; we cannot but be grateful to men who century by century handed on the tale of such spiritual strife and attainment.

APPENDIX

ECCLESIASTICAL DIVISIONS OF THE COUNTY

Mediaeval Hertfordshire was divided between the two dioceses of London and Lincoln, by far the greater proportion of parishes being under the latter see.¹

The whole of the eastern portion of the county from Royston southwards to Cheshunt lay in the diocese of London and its archdeaconry of Middlesex, which last came into being before 1138.² With the exception of Albury, Brent Pelham and Furneux Pelham, peculiars of the Dean and Chapter of St. Paul's, all these parishes were included in the rural deanery of Braughing. The deanery far exceeded the hundred in extent,³ and was fully organized in 1291, when it contained the parishes of Amwell, Anstey, Barkway, Braughing, Broxbourne, Buckland, Cheshunt, Eastwick, Gilston, Much Hadham, with its chapelry of Little Hadham, Great and Little Hormead, Hunsdon, Layston, Meesden, Brent Pelham, Furneux Pelham, Sawbridgeworth, Stanstead Abbots, Bishop's Stortford, Thorley, Ware, Widford and Wyddial.⁴ To these must be added Stocking Pelham, Reed, Royston,⁵ Standon, Thundridge and Wormley. These parishes remained in the archdeaconry of Middlesex until 1845.⁶

The western half of the county lay within the diocese of Lincoln, and was divided between the two archdeaconries of Huntingdon and St. Albans, this last being a peculiar. The diocese was divided into seven archdeaconries by Remigius (1067–92), who placed the three counties of Cambridge, Huntingdon and Hertfordshire under the care of one Nicholas, the first archdeacon.⁷ On the formation of the see of Ely in 1109 Cambridgeshire became part of that diocese,⁸ but the greater part of Hertfordshire remained in the archdeaconry of Huntingdon until 1845.⁹ The parishes in this archdeaconry were organized under the rural deaneries of Baldock, Berkhamstead, Hertford and Hitchin, all of which were formed before 1291.¹⁰ In no case did these deaneries correspond with a hundred.

The deanery of Baldock comprised the twenty-three parishes of Ardeley, Aspenden, Aston, Baldock, Benington, Bygrave, Caldecote, Clothall, Cottered, Hinxworth, Kelshall, Great Munden, Little Munden, Radwell, Rushden, Therfield, Throcking, Wallington, Walkern, Westmill, Weston, Welwyn and Willian.

The deanery of Berkhamstead included the fourteen parishes of Aldbury, Aldenham, Berkhamstead St. Mary (Northchurch), Berkhamstead St. Peter, Great and Little Gaddesden, Hemel Hempstead, King's Langley, Kensworth, North Mimms, Puttenham, Shenley, Tring and Wheathampstead; of these Aldenham and Shenley were outliers.¹¹

The deanery of Hertford contained the seventeen parishes of Ayot St. Peter and Ayot St. Lawrence, Bengoe, Little Berkhamstead, Bramfield, Digswell, Datchworth, Essendon, Bishop's Hatfield, St. Andrew Hertford, St. Nicholas Hertford, Hertingfordbury, Sacombe, Stapleford, Tewin, Watton at Stone and Welwyn.

¹ For the historical significance of this division see H. M. Chadwick, *The Origin of the English Nation*, 2, 3.

² Ralph de Diceto, *Hist. Works* (Rolls Ser.), i, 251.

³ The hundred contains the parishes of Braughing, Eastwick, Gilston, Hunsdon, Sawbridgeworth, Standon, Stanstead Abbots, Thorley, Thundridge, Ware, Westmill and Widford. Of these Westmill was in the diocese of Lincoln.

⁴ *Pope Nich. Tax.* (Rec. Com.), 18, 20.

⁵ Constituted a separate parish in 1540 (Stat. 32 Hen. VIII, cap. 44).

⁶ See below.

⁷ Henry of Huntingdon, *Hist. Angl.* (Rolls Ser.), 302.

⁸ William of Malmesbury, *Gesta Pontif.* (Rolls Ser.), 325.

⁹ See below.

¹⁰ *Pope Nich. Tax.* (Rec. Com.), 36, 37.

¹¹ Owing to the intrusion of the archdeaconry of St. Albans.

ECCLESIASTICAL HISTORY

The remaining deanery, that of Hitchin, was composed of the fourteen parishes of Chelsfield, Graveley, Hitchin, Ickleford, Kimpton, Knebworth, Letchworth, Lilley, Offley, Pirton, Stevenage, King's Walden and Great and Little Wymondley.

The extensive liberties enjoyed by the Abbots of St. Albans secured freedom from the ordinary archidiaconal jurisdiction for the parishes in the possession of their house. These were accordingly organized at least as early as 1190¹² under the archdeaconry of St. Albans, which later comprised the parishes of Bushey, Codicote, East Barnet, Chipping Barnet, Elstree, Hexton, Abbot's Langley, Northaw, Norton, Redbourn, Rickmansworth, Ridge, St. Albans, St. Michael's, St. Paul's Walden, St. Peter's, St. Stephen's, Sandridge, Sarratt, Shephall, and Watford, and also the Buckinghamshire parishes of Abbot's Aston, Grandborough, Little Horwood and Winslow.

The abbey was surrendered to the Crown in December 1539. The event had, of course, been anticipated, and at the beginning of the year St. Albans had been included by Henry VIII in a list of dissolved houses which were to become the seats of his proposed new bishoprics. 'For as muche,' the king wrote, 'as it is not unknowne the slowthful and ungodly lyf which hath been usid amongst all thos sort whyche have borne the name of religius folke, and to the intente that hens forthe meny of them myght be tornyd to better use, as herafter shall show werby Gode's worde myght be better sett forthe, chyldron brought up in lernyng, clerces nuryshyd in the universites and servantes decayed to have lyfynges, almes housys for pour folke to be sustaynyd, and leders of grece, ebrew and latyne to have payd stypende, dayly almes to be mynstrate, mendyng of hyght wayse, exhybissun for mynsters of the chyrche. It is thought therfore unto the kynges hyghtnes most expedient and necessary that mo bysshopprycys, colegyall and cathedrale chyrchys shube establyshyd insted of thes forsayd relygyus housys w' in the fondacion werof thes other tytylles affore rehersyd shalbe stablysyd.'¹³ The Act to which this was the preamble was passed in May 1539; it empowered Henry to create under the great seal such new bishoprics as might seem good to him.¹⁴ Under this Act a scheme was prepared for the foundation of twenty-one new sees,¹⁵ including Hertfordshire, with the abbey church of St. Albans as its cathedral.¹⁶ Essex was to form a separate diocese with its administrative centre at Waltham Abbey.

Unfortunately 'the best part of the scheme died under thought,'¹⁷ and nothing came of it in regard to St. Albans. A later Act of the same year provided that such places 'as were before exempted from the visitation and jurisdiction of the ordinary' within whose diocese they were situated should henceforth be included within the jurisdiction of such ordinary.¹⁸ But the archdeaconry continued as a royal liberty outside episcopal jurisdiction until 1551, when Edward VI by Letters Patent reconstituted it and annexed it to the diocese of London.¹⁹ This arrangement was confirmed by Queen Mary in 1554.²⁰

No further changes were made in the ecclesiastical divisions of Hertfordshire until 1845, when under the provisions of an Order in Council of 8 August²¹ the diocese of Rochester was reconstituted to include the archdeaconry of St. Albans; the Hertfordshire parishes of the dioceses of London and Lincoln were added to this archdeaconry, while the four Buckinghamshire parishes were removed to the archdeaconry of Buckinghamshire and diocese of Oxford. At the same time all peculiars were abolished.²² In 1863 the jurisdiction of the archdeaconry of St. Albans was extended to include the city and deanery of Rochester, and its title became 'the Archdeaconry of Rochester and St. Albans';²³ this arrangement was brought to an end by an Act passed in 1875, and separate archdeacons were again constituted.²⁴

This rearrangement was, however, only part of a much larger change, for the same Act founded a new diocese of St. Albans, which came into being on 4 May 1877.²⁵ By an Order in Council of 30 April 1877 the new see was given jurisdiction over Hertfordshire, Essex and the portion of Kent north of the Thames. The abbey church of St. Albans was assigned as the cathedral, subject to the rights of the incumbent; the bishop was constituted a body corporate,

¹² Add. Chart. 35537.

¹³ Cott. MS. Cleop. E iv, fol. 366.

¹⁴ Stat. 31 Hen. VIII, cap. 9.

¹⁵ See Geoffrey Hill, *Engl. Dioceses*, 388-9.

¹⁶ The establishment was to include a president of the college, ten prebendaries, a reader both of divinity and humanity, eight minor canons 'to singe in the quyer,' eight laymen to sing, eight choristers, a master of the children, a gospeller, an epistoler; provision was also made for an auditor, and a sum of £66 13s. 4d. was to be spent annually on repairs (Aug. Off. Misc. Bks. xxiv, fol. 15-16).

¹⁷ Collier, *Ecl. Hist.* (ed. Lathbury), v, 50.

¹⁸ Stat. 31 Hen. VIII, cap. 13.

¹⁹ Aug. Bk. 236, fol. 19; Newcourt, *Repert.* i, 94. These Letters were issued under Stat. 31 Hen. VIII, cap. 13.

²⁰ Newcourt, *Repert.* i, 94.

²¹ Under Stat. 6 & 7 Will. IV, cap. 77.

²² *Lond. Gaz.* 20 Aug. 1845, p. 2541.

²³ Stat. 26 & 27 Vict. cap. 36.

²⁴ *Ibid.* 38 & 39 Vict. cap. 34, § 9 (2).
Gaz. 14 Feb. 1882, p. 598.

The arrangement was not completed until 1882 (*Lond. Gaz.* 4 May 1877, p. 2943).

A HISTORY OF HERTFORDSHIRE

was invested with all episcopal right and jurisdiction, and was made subject to the Archbishop of Canterbury as metropolitan.²⁶

On the reconstitution of the diocese of Rochester and archdeaconry of St. Albans in 1845 the Hertfordshire parishes were arranged under the eleven rural deaneries of Baldock, Barnet, Benington, Berkhamstead, Hertford, Hitchin, St. Albans, Bishop's Stortford, Ware, Watford and Welwyn.

The deanery of Baldock contained the parishes²⁷ of Ashwell, Baldock, Bygrave, Caldecote, Clothall, Hinxworth, Kelshall, Newnham, Norton, Radwell, Sandon, Therfield and Wallington. It remained unchanged until 1882, when the parishes of Rushden, Walkern and Weston were added from the deanery of Benington. It was further enlarged by the addition of Royston from the deanery of Buntingford in 1884. Walkern was restored to Benington in 1892, and these parishes with their modern subdivisions now (1913) constitute the deanery.

The deanery of Barnet in 1845 contained the parishes of Chipping Barnet, East Barnet, North Mimms, Shenley and Ridge with their chapelries, and these parishes still remain in this division.

The deanery of Benington in 1845 contained Ardeley, Aspenden, Aston, Benington, Cottered, Great Munden, Little Munden, Rushden, Throcking, Walkern, Westmill and Weston. In 1882 this deanery was abolished; nine years later the name was revived, the deanery of Buntingford being called the deanery of Buntingford and Benington. In 1892 it was freshly constituted with its old parishes, with the exception of Rushden and Weston, which were removed to Baldock deanery. The parish of Sacombe was added from Welwyn deanery in 1895.

In 1845 the deanery of Berkhamstead contained the parishes of Aldbury, Berkhamstead St. Mary, Berkhamstead St. Peter, Great Gaddesden, Little Gaddesden, Kensworth, Puttenham, Tring and Wigginton. To these Hemel Hempstead was added in 1907, when Kensworth and the modern vicarages of Flamstead and Markyate Street were removed to the deanery of St. Albans.

The deanery of Hertford in 1845 contained the parishes or chapelries of Bayford, Bengo, Little Berkhamstead, Essendon, Hatfield, All Saints with St. John, Hertford, St. Andrew with St. Mary and St. Nicholas, Hertford and Hertingfordbury. To these Stapleford, formerly in the deanery of Welwyn, was added in 1907.

In 1845 the deanery of Hitchin was composed of the parishes of Graveley, Hexton, Ickleford, Ippollitts, Letchworth, Lilley, Offley, Pirton, Stevenage, King's Walden, Willian and Little Wymondley. Abbot's Walden was added in 1895, having been previously in the deanery of Welwyn.

The deanery of St. Albans in 1845 contained the parishes of the abbey church, St. Michael's, St. Peter's, St. Stephen's, Hemel Hempstead, Redbourn, Sandridge and Wheathampstead. Hemel Hempstead was removed to the deanery of Berkhamstead in 1907, while this deanery was increased by the addition of Elstree and the modern vicarage of Radlett from the deanery of Watford and of the parish of Kensworth, and modern vicarages of Flamstead and Markyate Street from the deanery of Berkhamstead.

In 1845 the deanery of Bishop's Stortford contained the parishes of Albury, Braughing, Gilston, Much Hadham, Little Hadham, Sawbridgeworth, Standon, Bishop's Stortford, Thorley and Widford. Widford was removed to the deanery of Ware in 1907, but otherwise the constitution of the deanery has remained unchanged.

The deanery of Ware in 1845 comprised Great Amwell, Broxbourne, Cheshunt, Eastwick, Hoddesdon, Hunsdon, Stanstead Abbots, Thundridge, Ware and Wormley. To these Widford was added in 1907.

The parishes contained in the deanery of Watford in 1845 were Aldenham, Bushey, Elstree, Abbots Langley, King's Langley, Rickmansworth, Sarratt and Watford.²⁸ Elstree was removed to the deanery of St. Albans in 1907.²⁹

In 1845 the deanery of Welwyn contained the parishes of Ayot St. Lawrence, Ayot St. Peter, Bramfield, Codicote, Datchworth, Kimpton, Knebworth, Sacombe, Shephall, Stapleford, Tewin, St. Paul's Walden, Watton at Stone and Welwyn. Of these St. Paul's Walden was removed to the deanery of Hitchin and Sacombe to that of Benington in 1895.

²⁶ For a further order see *Lond. Gaz.* 13 July 1877, p. 4126. Under Stat. 3 & 4 Geo. V, cap. 36, the Essex parishes are about to be constituted under the newly-created see of Chelmsford.

²⁷ The following lists are taken from the *Clergy Lists and Diocesan Calendar*.

²⁸ Much of the parish of Watford has now been divided among six daughter churches.

²⁹ Together with the modern vicarage of Radlett, formerly in the parish of Aldenham.

Hertfordshire was at this date 1535 under the following jurisdictions:-

BISHOPRIC OF LONDON & ARCHDEACONRY OF MIDDLESEX
 The Deanery of Braughing
ARCHDEACONRY OF ST. ALBANS
 The Jurisdiction of St. Alban's Abbey

BISHOPRIC OF LINCOLN & ARCHDEACONRY OF HUNTINGDON
 The Deanery of Baldock
 " " " Berkhamstead
 " " " Hertford
 " " " Hitchin

Note The parishes of Aldenham, North Mimms and Shenley are in the deanery of Berkhamstead; the parish of Wormley is under the jurisdiction of the Abbot of Waltham, Holy Cross (Essex), the parish of Markyate is in the deanery of Dunstable (Beds) and the parish of Holwell is in the deanery of Shefford (Beds).

ECCLESIASTICAL MAP OF HERTFORDSHIRE

Showing the Rural Deaneries as existing at the time of the Valor, 1535 and the Religious Houses.

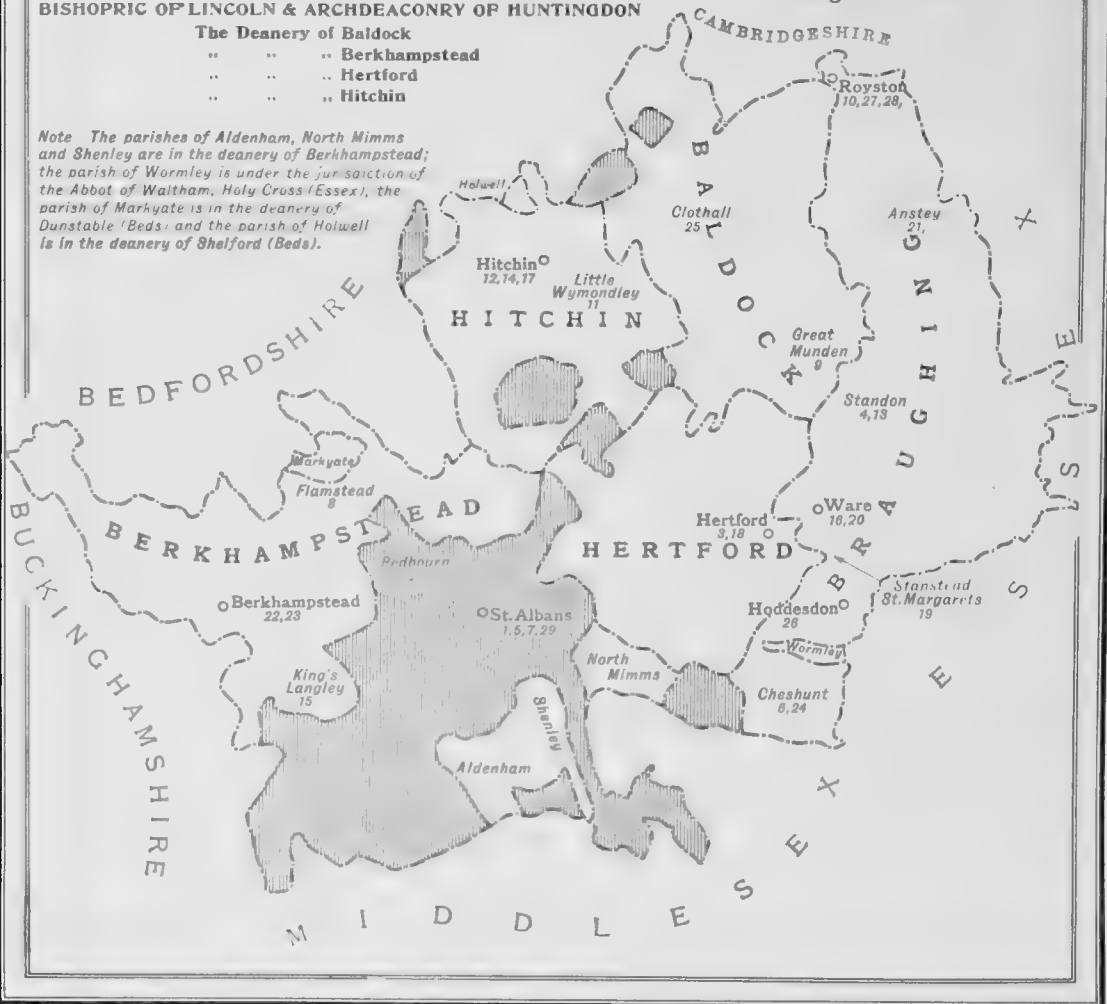

REFERENCE TO RELIGIOUS HOUSES

BENEDICTINE MONKS

1. St. Albans Abbey
2. Redbourn Priory
3. Hertford Priory
4. Salburn in Standon Priory

BENEDICTINE NUNS

5. Sopwell Priory
6. Cheshunt Priory
7. St. Albans, St. Mary de Pre Priory
8. Flamstead, St. Giles in the Wood Priory
9. Great Munden, Rowney Priory

AUSTIN CANONS

10. Royston Priory
11. Wymondley Priory

GILBERTINE CANONS

12. Hitchin, New Bigging Priory

KNIGHTS HOSPITALLERS

13. Standon Preceptory

KNIGHTS TEMPLARS

14. Temple Disney Preceptory

FRIARIES

15. King's Langley Priory
16. Ware, Friars Minor
17. Hitchin, Carmelite
18. Hertford, Trinitarian

COLLEGIATE HOUSE

19. Thele or Stanstead St. Margaret's

ALIEN HOUSES

20. Ware Priory

HOSPITALS

21. Anstey, St. Mary Bigging
22. Berkhamstead, St. John Baptist
23. Berkhamstead, St. John the Evangelist
24. Cheshunt, St. Erasmus and St. Mary Magdalene
25. Clothall, St. Mary Magdalene
26. Hoddesdon, St. Laurence St. Anthony
27. Royston, St. John and St. James
28. Royston, St. Nicholas
29. St. Albans, St. Julian

THE RELIGIOUS HOUSES OF HERTFORDSHIRE

INTRODUCTION

IN considering the religious houses of Hertfordshire the main impression is that of the overwhelming pre-eminence of St. Albans Abbey. The abbey indeed had more than a great local position, which was of course insured by its possessions and its ecclesiastical and secular jurisdiction. In virtue of the saint over whose relics it arose it held the first place among English abbeys, while the fame of its culture and discipline at one period reached foreign countries. Its name deserves to be honoured to-day for the service rendered to history by the literary labours of its monks. The other Benedictine monasteries were all dependent houses: Hertford and Redbourn Priors were cells of St. Albans, the second practically an annex of the abbey; the priory at Ware, the one alien priory in the county, was a cell of the abbey of St. Evroul in Utica; and the small community at Salford in Standon, a dependency of Stoke in Suffolk. From a reference about the middle of the 12th century to 'the monks serving God in the church of Sawbridgeworth'¹ it is possible that the priory of Hurley or Walden, owners respectively of the tithes² and church of Sawbridgeworth,³ may have maintained a cell here at one time. The existence of this house is, however, quite problematical. Richard Abbot of St. Albans (1097-1119) contemplated the foundation of a subject monastery at Langley,⁴ but the project was not carried out.

There were Benedictine nunneries at Cheshunt, Rowney in Little Munden, Flamstead and Sopwell near St. Albans, all founded during the 12th century, though, if the convent placed at Sopwell was an offshoot of the abbey, as seems likely, it could claim an earlier origin. All were more or less small and poor, but Sopwell's connexion with St. Albans saved it no doubt from pecuniary cares and difficulties and gave it a certain standing. The Cistercians were not represented in Hertfordshire; nor were the Carthusians, in spite of the avowed intention of the Countess of Pembroke in 1362 to establish monks of this order either at Westmill, Meesden or Little Hormead.⁵

¹ In a letter of William de Albini Brito to his men of Sawbridgeworth (*Madox, Hist. of Exch.* i, 120).

² Newcourt, *Repert.* i, 867.

³ Geoffrey de Mandeville granted the church to Walden Priory, which he founded in 1136 (*Dugdale, Mon.* iv, 133).

⁴ *Gesta Abbatum Mon. S. Albani* (Rolls Ser.), i, 149.

⁵ Inq. a.q.d. file 365, no. 18.

A HISTORY OF HERTFORDSHIRE

The only Gilbertine house, the priory of New Bigging, Hitchin, did not arise before 1361 and had few inmates.

There were two houses of Austin Canons, the one at Royston, founded shortly before 1181, of some importance on account of its privileges, but the other at Little Wymondley never anything but insignificant.

The Knights Templars had a preceptory at Dinsley, probably as early as the reign of Henry II; the Knights of St. John, who succeeded them there, maintained for a time a community at Standon on the estate given to them at the end of the 12th century.

A hospice especially for Franciscans and Dominicans was built shortly before 1247 within the precinct of St. Albans,⁶ but the Mendicants, perhaps on this account, never got a permanent footing in the town. The three friaries of the county were of rather late date: the priory of Friars Preachers within the royal manor of Langley was founded in 1308 by Edward II, who was probably also responsible for the establishment of Carmelites in 1317 at Hitchin; the Friars Minors did not settle at Ware until 1339. Langley, of which the king was patron in a very special sense, must have had a considerable position; the other two houses were obscure. The sole nunnery of a Mendicant order was the priory of Langley, refounded by Queen Mary for Dominican sisters.

Counting St. Nicholas Royston, which seems, however, to have been within the boundary of Cambridgeshire, there were eleven hospitals.^{6a} Five or six of these besides St. Nicholas were for lepers: St. Julian's and St. Mary de Pré near St. Albans, St. John Evangelist at Berkhamstead, St. Mary Magdalene, Clothall,⁷ St. Mary Magdalene near Hertford, and perhaps St. Laud and St. Anthony, Hoddesdon. The first two were dependent on and closely connected with the abbey: for instance, sisters of three successive abbots in the 14th century entered St. Mary de Pré.

The hospital outside Hertford about 1261 was transformed into a house of Maturine friars; St. Mary de Pré before the end of the 14th century also underwent a change and became a Benedictine nunnery. The other hospitals were at Anstey, Cheshunt, Berkhamstead and Royston, none apparently earlier than the 13th century.

The one college was that in the church of St. Margaret, Thele.

From time to time there must also have been many cases of persons living a religious life in solitude. The oratory of St. German, St. Albans, was used as a hermitage in Saxon days⁸; a recluse called Roger⁹ and Sigar, a hermit of Northaw, who lived in Abbot Geoffrey's time,¹⁰ established such reputations for sanctity that pilgrimages were made to their tombs in the conventual church of St. Albans¹¹; the anchorite living in 1258 at St. Peter's¹² had successors in the 15th century, when there is mention too of recluses at St. Michael's.¹³

⁶ Matt. Paris, *Chron. Maj.* (Rolls Ser.), iv, 600. ^{6a} There were perhaps more. A hospital is mentioned once in connexion with Offley (see p. 310) and there is reference to one at Therfield in 1566 (Cler. Subs. R. bdle. 40, no. 820), but this may have been a house of post-Reformation foundation.

⁷ The hospital at Baldock mentioned by Tanner is the same as this house, which in the course of its history was transferred from one site to another. ⁸ *Gesta Abbat.* i, 21.

⁹ If he really lived at Markyate (*ibid.* 97), he does not belong to Hertfordshire (see Sopwell Priory).

¹⁰ *V.C.H. Herts.* ii, 358.

¹¹ *Gesta Abbat.* i, 105.

¹² *Ibid.* 388-9.

¹³ *V.C.H. Herts.* ii, 403 n. In 1530 there was a hermit or anchorite in the chapel of St. Mary Magdalene (*ibid.* 401).

RELIGIOUS HOUSES

Of the communities very few lasted until the General Dissolution. With the exception of Hoddesdon, which continued up to 1575 as a kind of almshouse, all the hospitals mentioned had disappeared before 1530, or survived only as chantries; the college at Thele had come to an end in 1431, the preceptories of the Hospitallers before 1500; and the monastery at Salford had ceased to exist in the 14th century; Rowney Nunnery and the alien priory at Ware had been dissolved in the 15th century; Redbourn Priory had been abandoned before the Act of 1536, under which the houses of Cheshunt, Flamstead, Sopwell, Royston and Wymondley were suppressed.

HOUSES OF BENEDICTINE MONKS

I. ST. ALBANS ABBEY

BEFORE THE CONQUEST

The legend of the foundation of St. Albans Abbey has been graphically written by Matthew Paris, a 13th-century monk of the abbey. According to his account Offa II, King of the Mercians, desired to found a monastery in atonement for the murder by Quendreda, his queen, of Ethelbert, King of the East Angles, a suitor for the hand of their daughter.¹ Being at Bath in 793, Offa, it is said, was visited one night by an angel who admonished him to raise the body of St. Alban, 'protomartyr of the English or Britons,' and place it in a more worthy shrine.² The king told Humbert or Higbert, Archbishop of Lichfield, of his vision, who, taking with him the Bishops of Lindsey and Leicester with a multitude 'of both sexes and divers ages,' went to Verulamium, where they were joined by Offa. There the place of Alban's burial being forgotten, the king was guided to it by a ray of light, and upon digging the ground the body of the martyr with the relics of divers saints left there by St. German were found.³ The archbishop and bishops raised the relics from the sepulchre and carried them in procession with hymns and shouts of praise to a church outside the town of Verulamium, built by the early British converts, and consecrated in honour of St. Alban. After this the king called a synod (or provincial council) at 'Celchyth' in 793, at which it was determined to establish a monastery, where the relics of St. Alban should be preserved. For this purpose a large endowment was made by Offa and Egrith, his son, with the consent of the synod, and extensive liberties, including, as Matthew Paris asserts, freedom from all interference by ecclesiastics or laymen, were granted.

That Offa wished to found a monastery, and

¹ *Vita Offae Secundi* (Wats ed.), 983.

² Matt. Paris, *Chron. Maj.* (Rolls Ser.), i, 356; Will. of Malmesbury, *Gesta Pontificum* (Rolls Ser.), 316.

³ See above, p. 286.

that his choice fell upon a spot near Verulamium on account of the sanctity of the memory of St. Alban, is doubtless correct. Nevertheless, a further determining factor in the selection of the site was that the productive lands in England had been at this time granted out and settled, and there only remained the forests and marshes with which to endow any newly-founded monastery. Besides which monks seem to have been the great settlers of unreclaimed land.⁴

The gift of so many 'manses' or 'mansiones' or land of so many 'manentes' did not indicate a strictly defined area,⁵ but probably a district of waste land such as all the south and south-west parts of Hertfordshire then were.⁶ This manner of endowment led later to many disputes and to the system of forging charters in support of claims. Although Offa's and Egrith's charters, which the monks of St. Albans proffered as their original title deeds, are probably such forgeries, yet their contents as regards the territorial gifts may be correct in substance. Offa's original endowment⁷ of 34 'mansiones' at Caegesho or Cashio

⁴ Elton, *Origins of Engl. Hist.* 228. The monasteries of Worcester, Evesham, Pershore and Westminster divided the greater part of Worcestershire, which was unreclaimed forest, and cleared and settled it; St. Augustine's and Christ Church, Canterbury, drained and settled the great marsh districts of south-east Kent, and it was the same with Croyland in Lincolnshire and Westminster in Western Middlesex.

⁵ Maitland, *Domesday Bk. and Beyond*, 227.

⁶ Offa's charter suggests that the lands granted to the abbey were woodland, for in it he forbids anyone to do harm either to the church or the woods (*silvis*) belonging to the monastery (Matt. Paris, *Chron. Maj.* vi, 2).

⁷ These charters are all taken from Cott. MS. Nero, D i, fol. 148, 148 d., and are printed in the most accessible form in Matt. Paris, *Chron. Maj.* vi, add. 1-11. See also Birch, *Cart. Sax.* i, 367, 373, 388, 389; Dugdale, *Mon.* ii, 223, 224; Kemble, *Cod. Dipl.* i, 195, 197, 208, 209. The charters were confirmed by Insepimus of Edward IV printed by Clutterbuck, *Hist. and Antiq. of Herts.* i, App. 1.

A HISTORY OF HERTFORDSHIRE

and 6 'mansiones' at 'Heanhamstede,' probably Park, represented the whole of the south-west section of what is now the county, comprising most of the later hundred of Cashio, and forming, roughly, a triangle with Sandridge as the apex and the county boundary from Rickmansworth to Barnet as the base, later representing some twelve ancient parishes containing over 60,000 acres. There was further included in Offa's grant a great area of Middlesex forest expressed as 10 'mansiones' in Stanmore which is said to have extended to London.⁸

In 795 Offa added a great district around Winslow, in Buckinghamshire, probably comprising the greater part, if not all, of the old hundred of Mursley. The lands are described as 12 'manentes' at Winslow and 3 'manentes' at Salden (Scelfdune) or 'Baldinogotum,' and 10 'manentes' at 'Scuccanhlau' or 'Fenn-tunn' with the wood called Horwood,¹⁰ to which were added 5 'manentes' at 'Lygeton.'¹¹ Egfrith, son of Offa, in 796 also granted 5 'manentes' at 'Pinnelesfeld'¹² and 10 'manentes' at 'Thyrfelde.'¹³ These lands formed the original endowment of the abbey. They were probably very sparsely populated, each of the 'manentes' or 'mansiones' possibly represented the land of a household, and later equated with a hide.¹⁴

Before dealing with the history of the monastery during the Anglo-Saxon period it may be well to state that the main sources of information are the various works of Matthew Paris, whose material for this period is evidently scanty. It is clear that the lists of the abbots set out in the 'Vitae Abbatum'¹⁵ and 'Gesta Abbatum'¹⁶ are unreliable. Only two abbots' names are given for a period covering a little over a hundred years beginning early in the 9th century, and there is a confusion regarding the abbots in the 10th century. Matthew Paris viewed the conduct of the 9th and early 10th-century abbots from a 13th-century standard. He could not appreciate the life in a Saxon

monastery in the 9th century. If, as he asserts, the abbey was founded for the Benedictine rule, that rule was soon afterwards very laxly kept or abandoned before its revival in the 10th century, for it is obvious from what he tells us that the abbots, like other Saxon abbots, lived in the abbey with their families, and their manner of living savoured more of the secular than monastic life. The abbey was always distinctly an aristocratic house. All the Saxon abbots were drawn from the nobility, many of them being kinsmen of the reigning monarchs. The monks came from the same class, and Abbot Leofric would not receive any as monks unless they were well born.¹⁷ Like many other Saxon abbeys, St. Albans was a double monastery and comprised both men and women.¹⁸

Willigod the priest, a faithful minister of Offa, was appointed the first abbot. He was to teach the monastic life, and after his death the brethren with the counsel of the bishop should elect one of themselves as his successor, but if it should happen that no one worthy should be found, the bishop, with the consent of the brethren, was to appoint a successor. It was determined at this time¹⁹ that Offa should himself visit Rome to treat with the pope for the canonization of Alban and to procure special liberties for the monastery then to be built. Offa went to Rome, and Pope Adrian I granted all that he asked, and adopted, it is said, the monastery as a daughter of the Roman Church, making it subject only to the apostolic see without interference of any archbishop or bishop,²⁰ which claim to exemption overriding the provisions of Offa's first charter is probably a later invention.²¹ Offa at the same time granted Peter's Pence from his lands in England, excepting to St. Albans Monastery the Peter's Pence collected in its lands.²²

On his return to England Offa granted further lands to St. Albans in 795. In the meantime Willigod had brought together monks specially selected for their holiness,²³ and a church was built by Offa and apparently finished in that year, for Offa then

⁸ *Gesta Abbatum Mon. S. Albani* (Rolls Ser.), i, 50.

⁹ This has been identified with Shecklow in Bucks.

¹⁰ This is identified by Luard (*Chron. Maj.* [Rolls Ser.], vi, 5) as Harwood, part of Brill Forest, but it is clearly Horwood near Winslow, where St. Albans held lands.

¹¹ Possibly Luton, co. Beds.

¹² Pinnelesfeld has been identified with the manor of Pinchfeld in Rickmansworth.

¹³ Thyrfelde has been identified with Therfield in Herts. and Weston Turville in Bucks., but there is no evidence that St. Albans held lands at either of these places.

¹⁴ See will of King Æthelwulf, where reference is made to 'decem hidis vel mansionibus' [vel manentibus] (Matt. Paris, *Chron. Maj.* i, 386 and note).

¹⁵ Matt. Paris, *Chron. Maj.* (Wat's ed. 1640).

¹⁶ Printed in the Rolls Series.

¹⁷ *Gesta Abbat.* i, 31.

¹⁸ *Ibid.* 11.

¹⁹ Matt. Paris, *Chron. Maj.* i, 358.

²⁰ *Ibid.* 359.

²¹ See marginal note by Matt. Paris in *ibid.* vi, 2. This claim was probably invented when the monastery desired exemptions from episcopal authority in the 12th century. See the appointment of Abbot Wulsin and episcopal control under Abbot Richard.

²² In *ibid.* i, 361, Matt. Paris states that St. Albans was to have Peter's Pence collected from all Hertfordshire, obviously an anachronism. In *Gesta Abbatum* i, 5, it is stated that the abbey was to have Peter's Pence from their lands.

²³ *Gesta Abbat.* i, 4; *Chron. Maj.* i, 360; *Vita Offae Secundi*, 30.

RELIGIOUS HOUSES

appears to have visited it and laid his charter upon the high altar in the presence of the convent and a great gathering of magnates.²⁴ Offa died shortly afterwards, in July 796, and Willigod within two months later died of remorse for not having secured the burial of the founder of their house at St. Albans.²⁵

Willigod was succeeded as abbot in 796 by Eadric, a kinsman of King Offa, who seems to have met with some opposition to his rule, but governed the monastery with a firm hand.²⁶ Wulsig, called the third abbot, is said to have succeeded in the time of St. Edmund (856-70), and ruled till the time of Athelstan (925-40). He was one of the royal house, and is described as a proud man, dressing in silks and living rather as a prince than a monk. He excited scandal by inviting noble women to his table, and wasted the substance of the abbey on his female relations, probably his daughters, whom he married to nobles and gave them portions from the possessions of the abbey. The convent rose against him, and he is said to have died from poison. His kinsmen, who had fattened on the goods of the abbey, were dismissed and the property of the house rescued.²⁷

Wulnoth, called the fourth abbot, was elected apparently in the time of King Athelstan (925-40). He spent two or three years in correcting the evil doings of his predecessor, and changed the colour and form of the habit of the monks. He ordained that the nuns (*sanctimoniales semisaeculares*), whom his predecessor had placed in a house too near the church, should live together in one house in the almonry to avoid suspicion, and should hear matins and the daily hours in the greater church (*in majori ecclesia*), and should be restricted in their eating of meat.²⁸ Wulnoth later relinquished his zeal for reform and indulged in hunting and sport, neglecting the care of the monastery to the scandal of religion. Matthew Paris refers to the plundering of the abbey by Danes in the time of this abbot and the carrying off of the relics of St. Alban to Denmark,²⁹ but the account is an interpolation and with little doubt refers to a later episode, which will be dealt with hereafter. Abbot Wulnoth afterwards repented of his evil ways, and after ruling the monastery for eleven years died from a stroke of paralysis. He was succeeded by Eadfrith, the fifth abbot,³⁰ a member of the Saxon aristocracy who had been prior. He is described as good-looking in appearance, but vain and despicable in conduct, constantly

in his chamber, rarely in the cloister and never in the quire. He presented a precious chalice to the monastery, and with his permission Ulf, the prior, built the chapel of St. German on the site of the house where St. German was supposed to have dwelt and where the body of St. Alban was found. Here he lived the life of a hermit, and after his death Abbot Eadfrith, repenting from his evil living, resigned his office of abbot and retired to this hermitage.³¹

This brings us to the middle of the 10th century, to the time of the revival of the Benedictine rule and the introduction of reform into the English monasteries. In consequence probably of these changes the abbey remained vacant for a year owing to discord among the monks as to the election of a successor, the greater number favouring the prior and the minority, probably the party of reform, opposing him. At length the discord was compromised by the intervention of the bishop, and Wulsin was elected abbot. His appointment, however, was but a compromise, and on that account he is unlikely to have effected any great changes in the monastery. Besides which he was evidently an old man when he undertook the office, as his rule was not a long one, and we are told that he died full of days. He is described as a pious man, and it is said that he established the market-place at St. Albans and encouraged people to settle there, assisting them with money and material. It is also recorded that he built the churches of St. Peter in the north, St. Stephen in the south, and St. Michael in the west of the town.³²

Great confusion follows from this date in the account of the abbots given in the *Gesta Abbatum*. It is here stated that Wulsin, the sixth abbot, was succeeded by Ælfric, the seventh abbot, Ealdred, the eighth abbot, Eadmer, the ninth abbot, Leofric, the tenth abbot, Ælfric II, brother of Leofric, the eleventh abbot, afterwards Archbishop of Canterbury, and Leofstan, the twelfth abbot.³³ From other evidence, however, a more probable succession seems to be that here suggested.

When St. Oswald, then Bishop of Worcester, desired a place in which to establish the regular monks, for whom there was not room at Worcester and Westbury, he was offered by King Edgar the choice of the monasteries of St. Albans, Ely, or Benfleet, in Essex. Instead,

³¹ *Gesta Abbat.* i, 6.

³² *Ibid.* 22. St. Michael's Church is situated within the city of Verulamium, a grant of the site of which the abbey did not receive till some fifty years later. It is improbable that the abbot would build a church on land which was not his, and therefore that this church was built till early in the 11th century. This date would correspond better with its architecture.

³³ *Op. cit.* i, 23-40.

²⁴ *Gesta Abbat.* i, 6.

²⁵ *Ibid.* 7.

²⁶ *Ibid.* 9.

²⁷ *Ibid.* 10.

²⁸ *Ibid.* 11.

²⁹ *Ibid.* 12.

³⁰ *Ibid.* 21.

A HISTORY OF HERTFORDSHIRE

however, of selecting any of them he founded in 968 the monastery of Ramsey.³⁴ At the same time he did not lose the opportunity of furthering the interests of reform, and used his influence with the king to procure the appointment of men of his own views to fill the vacancies at these abbeys. The monasteries of St. Albans, Ely and Benfleet, we are expressly told, were emptied of secular clerks, who were replaced by professed monks, and Ælfric, son of an ealdorman of Kent, was made Abbot of St. Albans.³⁵ Ælfric had been a monk at Abingdon, where we may be sure he had imbibed the views of Æthelwold with regard to monastic vows, and was evidently a friend of Dunstan, for the *Sancti Dunstani Vita Auctore B* is dedicated to him.³⁶ Matthew Paris states that he was chancellor to Æthelred while he was a layman (*saecularis*); so that he was apparently middle-aged when he became a monk. It is probable that he brought in some monks from Abingdon or elsewhere to teach and enforce the Benedictine rule, and those in the monastery who would not accept it were expelled. We have unfortunately no authentic information as to his life at St. Albans. We are told that he purchased Kingsbury from the king, destroyed the castle and drained the fishpool,³⁷ but there is some doubt even as to this small item of information. Having regard to the confusion existing between Ælfric and his brother Leofric, it seems probable that much attributed by Matthew Paris to the latter refers to the former. The famine mentioned as in the time of Leofric³⁸ is probably that of 976,³⁹ when Ælfric was, so far as we know, still abbot, for he was not made Bishop of Ramsbury till 990. The abbot at the time of this famine is said to have spent the treasure and

goods of the monastery in the relief of the starving poor, which caused much dissent among the monks.⁴⁰ After being at Ramsbury for a few years Ælfric was made Archbishop of Canterbury in 995,⁴¹ and at his death in 1005 he left considerable property to St. Albans Abbey, and appointed his brother Leofric, then Abbot of St. Albans, his executor.⁴²

It is clear from Matthew Paris that one brother succeeded the other, and such dates as we have also point to this. Leofric, we are told, was a handsome and stately man, but despised all worldly vanities and refused to be Archbishop of Canterbury, asserting that his brother Ælfric was more worthy of the honour.⁴³ At the same time he was a respecter of persons, and would not admit as a monk of St. Albans anyone who was not well born.

Leofric was undoubtedly Abbot of St. Albans in 997, when he is so described as a witness to a charter.⁴⁴ He is again mentioned in 1005,⁴⁵ 1006⁴⁶ and 1007,⁴⁷ which is the last date when reference to him has been found. During his abbacy St. Albans seems to have been wealthy and many gifts and purchases of land were obtained. At one of the threatened invasions by the Danes at the end of the 10th century, when Æthelred was compelled to buy off the invaders, the abbot lent the king a large sum of money on security of lands. In redemption of this loan the king granted to the abbey in 1006 a 'cassata' of land at Flamstead and 5 'cassatae' at Verulamium.⁴⁸ The two brothers besides this grant acquired from the Crown lands at Kingsbury, Burston and Childwick, all near to St. Albans, Oxhey, Weston, Norton, Upton, Rodenhangar and elsewhere in Hertfordshire.⁴⁹

Abbot Leofric was probably succeeded about 1007 by Ealdred and he by Eadmar. Both these abbots, of whose dates there exists no independent evidence, are placed by Matthew

³⁴ *Hist. of the Ch. of York* (Rolls Ser.), i, 427. There does not seem to be sufficient evidence for Sir James Ramsay's assertion (*Foundations of England*, i, 326) that Edgar refounded St. Albans Abbey, which was, he says, at that time in a dilapidated condition.

³⁵ *Hist. of the Ch. of York* (Rolls Ser.), ii, 71, 495, 505; *Gesta Abbat.* (Rolls Ser.), i, 23. Much confusion has arisen as to the identity of this abbot, partly originating in a mistake of Matthew Paris followed by Walsingham in the succession of the abbots, who has confused Ælfric, afterwards Archbishop of Canterbury, with Leofric his brother. He has also been confused with Ælfric the grammarian, author of the celebrated homilies and lives of the saints, Ælfric Puttoc, Archbishop of York, and Ælfric, Abbot of Malmesbury.

³⁶ *Memorials of St. Dunstan* (Rolls Ser.); *Gesta Abbat.* i, 32. Matthew Paris must here mean Edgar.

³⁷ *Gesta Abbat.* i, 23, 32, 33. It is here supposed that the two Ælfrics given by Matthew Paris are the same person.

³⁸ *Ibid.* 29.

³⁹ *Anglo-Sax. Chron.* (Rolls Ser.), i, 230; *Matt. Paris, Chron. Maj.* i, 469.

⁴⁰ *Gesta Abbat.* i, 29-30.

⁴¹ It was stated that he also expelled the clerks at Canterbury and put monks in their place (*Anglo-Sax. Chron.* [Rolls Ser.], i, 244-5), but see *Dict. Nat. Biog.* under Ælfric.

⁴² Thorpe, *Cod. Dipl. Wills*, 547. The charter of 1007 of Æthelred to St. Albans refers to Leofric, Abbot of St. Albans, as brother of Ælfric, then late Archbishop of Canterbury (*Matt. Paris, Chron. Maj.* vi, 25).

⁴³ *Gesta Abbat.* i, 28.

⁴⁴ Kemble, *Cod. Dipl.* no. 698. It may be his name which occurs in 993 (*ibid.* no. 684).

⁴⁵ *Ibid.* no. 716; Thorpe, *Dipl. Angl.* 549.

⁴⁶ *Matt. Paris, op. cit.* vi, 22; *Dugdale, Mon.* vi, 219.

⁴⁷ Kemble, *Cod. Dipl.* no. 1304.

⁴⁸ *Matt. Paris, Chron. Maj.* vi, 21; *Dugdale, Mon.* ii, 225, no. x.

⁴⁹ *Cott. MS. Nero, D vii*; *Matt. Paris, Chron. Maj.* vi, 24.

RELIGIOUS HOUSES

Paris before Abbot Leofric, but as we have a definite date for Ælfric, who, as has been shown, was succeeded by his brother Leofric, there is no room for them unless they come after Leofric; besides which all we know about them is with regard to their excavations and searches at Verulamium, which was not granted to St. Albans till the abbacy of Leofric. Matthew Paris gives an account of the remains found during the excavations by Ealdred and tells a story of a cave at a place called 'Wormenhert,' which was the habitation of a dragon. This abbot collected a great store of stones, tiles and wood for the fabric of the church, but was prevented by his death from carrying out his intention of rebuilding the abbey.⁵⁰ Eadmar continued the work of his predecessor and collected more material from Verulamium. During the searches it is said some books were found, one of which was the life of St. Alban written in the ancient British language, and after being translated by a priest, Unwona, it fell to pieces. As no known manuscript has ever been discovered in the ancient British language the story is apocryphal. Like his predecessor, Eadmar left his intention of rebuilding the church unfulfilled.⁵¹

Matthew Paris gives a second Abbot Ælfric, but as some of the events attributed to his abbacy, such as the loan to King Æthelred, above referred to, appear from more authentic sources to belong to the time of Leofric, it seems probable that his existence forms a part of the confusion already mentioned. To the time, however, of this abbot, and in the reign of Edward the Confessor, Matthew Paris attributes the well-known story of the removal of the relics of St. Alban to Ely for security during a threatened invasion of the Danes, probably that of Magnus, King of Norway and Denmark, in 1045. The scare being over, the Abbot of St. Albans demanded the return of the relics, but the monks of Ely refused to restore them. After appeals to King Edward and the pope, the monks of Ely were induced to return what they professed were Alban's bones, retaining, however, what they considered were the true relics. The Abbot of St. Albans then declared that he had only pretended to send the real relics to Ely and the authentic bones he had concealed in his church. Later St. Alban, it is said, appeared to one of the monks and declared that his true relics had been hidden in the middle of the church, from which they were publicly and solemnly taken.⁵² Arising out of this story is the further legend of the carrying off of the bones of the saint to Odense in Denmark, where they were deposited in a monastery. This episode is given by Matthew Paris under the

abbacy of Wulnoth⁵³ in the first half of the 10th century, but as the Danes were then heathen and the priory of Odense was not founded till the 11th century, it is obvious that it belongs to a later date. By the recent researches of Mr. W. R. L. Lowe it has been shown that St. Canute or Knud came to England in the Danish expedition of 1069-70 to assist the English refugees under Hereward at Ely, and according to an 11th-century MS. 'Passio of St. Canute' and a tablet erected at Odense the Danish king St. Canute then carried back with him some of the supposed relics of St. Alban probably from those retained by Ely. These were deposited in the priory of St. Mary at Odense, which thereupon received the additional dedication to St. Alban, and it was in the church of this monastery that Canute was murdered in 1086.⁵⁴ The further story how Egwin the sacrist, after receiving a message from St. Alban in a dream, became a monk at Odense, where he stole the relics and sent them to England, is perhaps an adaptation from the legend as to the relics of St. Oswald taken from Peterborough.⁵⁵

The next abbot was apparently Leofstan 'surnamed Plumstan', who was appointed shortly after the accession of Edward the Confessor, possibly about 1048.⁵⁶ He had been a member of the royal household, and was the confessor of King Edward and Queen Edith, with both of whom he had considerable influence.⁵⁷ Possibly on account of his court interest he obtained numerous grants of lands from the nobility and others, and very largely from wealthy Danes, many of whom appear to have settled in the neighbourhood of the monastery.⁵⁸ He further improved the estates of the abbey by clearing the woods from the confines of the Chiltern district almost to London, at the same time securing the safety

⁵³ *Gesta Abbat.* i, 12-19.

⁵⁴ 'The Cult of St. Alban Abroad,' reprinted from the *Herfordshire Post*, 13 July 1910. The priory church at Odense has been destroyed, but the market-place there is still called St. Albans Market, and there is a St. Albans Bridge and St. Albans Street in the town. There is, again, another story that the bones of the saint were carried by Abbot Frederic to Ely when he fled there in 1077, which is indignantly denied by Matthew Paris (*Gesta Abbat.* i, 51). See also *Festskrift udgivet af Kjobenhavns Universitet: Knud den Helliges Martyrhistorie* (1907).

⁵⁵ Dugdale, *Mon.* i, 349.

⁵⁶ The earliest reference to him is in a grant by Ægelwin the Black to the abbey in his time, which is attributed to 1042-9 (*Gesta Abbat.* i, 39; Kemble, *Cod. Dipl.* iv, no. 962). A grant by Tova, a widow, to Leofstan the Abbot and the congregation of St. Alban is attributed to 1049-52 (*Gesta Abbat.* i, 39; Kemble, *Cod. Dipl.* iv, no. 950).

⁵⁷ *Gesta Abbat.* i, 38.

⁵⁸ Cott. MS. Nero, D vii.

⁵⁰ *Gesta Abbat.* i, 25.

⁵¹ *Ibid.* 28.

⁵² *Ibid.* 34-6.

A HISTORY OF HERTFORDSHIRE

of travellers and pilgrims to St. Albans by repairing Watling Street and the bridges on it. That the road might be maintained in safety he granted the manor of Flamstead to Turmot, a knight, who with two fellow knights was bound to keep those parts free from thieves and wild beasts. Leofstan died 'immediately after'⁵⁹ Edward the Confessor (5 January 1065-6), leaving the abbey 'overflowing with all good things.'⁶⁰

After, or perhaps a little before, the death of Leofstan the abbey seems to have been seized by that rapacious prelate Stigand, Archbishop of Canterbury,⁶¹ who at this time was obtaining the revenues of many of the larger monasteries. Besides St. Albans he held in this way the abbeys of Winchester, Glastonbury, St. Augustine and Ely.⁶² They did not, however, remain with him for many months, for Harold seems to have filled the vacancies. To St. Albans he appointed Frederic, who was descended from the old Saxon nobility, and was also a kinsman of King Cnut and a friend of King Edward and of Harold. We know nothing of what happened at St. Albans during Harold's brief reign. William the Conqueror must at once have recognized the abbey as a source of danger. Its great wealth and reputation and the intensely national and aristocratic tendency of its inmates, many of whom were of noble blood, compelled him to lessen its power and influence.⁶³ It is clear that he promoted the rivalry between St. Albans and Westminster by conveying to the latter much of the St. Albans property and giving to it lands adjoining those of St. Albans. In this way and by grants to his Norman followers William impoverished the abbey. Thus St. Albans lost its property in Middlesex, at Flamstead, Studham, Bushey, and probably Aldenham and other places in Hertfordshire.⁶⁴

Abbot Frederic was openly opposed to William, and immediately after the battle of Hastings and the death of Harold he gave the influence of his birth, position and wealth to the English party, headed by Aldred Archbishop of York, Earls Edwin and Morcar and

⁵⁹ 'Cito post' (*Gesta Abbat.* i, 41). ⁶⁰ *Ibid.*

⁶¹ This may account for the terms of William's charter to St. Albans, whereby the abbey was to hold such liberties in such places as Stigand had on the day King Edward died (*Matt. Paris, Chron. Maj.* i, 33). From this it would appear that Leofstan died before Edward or that Stigand held the abbey before Leofstan died. This theory is confirmed by Domesday, where, under the abbot's manor of Redbourn, it is stated that Stigand held it at the time King Edward died, but he could not alienate it from the abbey, and Napsbury was held by a man of Stigand on the same terms (*V.C.H. Herts.* i, 275, 315).

⁶² *Historiae Anglicanae Script. Vet.* (Hist. Eliensis, c. 41), iii, 514.

⁶³ *Gesta Abbat.* i, 50. ⁶⁴ See under Topography.

the townsmen of London to place Edgar Etheling on the throne.⁶⁵ At that memorable occasion when William was met at Berkhamstead by Aldred Archbishop of York, Edgar Etheling, Edwin and Morcar and all the chief men of London⁶⁶ who submitted to him, Abbot Frederic, according to Matthew Paris, administered the oath⁶⁷ whereby William swore on the relics of St. Alban that he would be a loving lord to them.

Abbot Frederic appears to have been looked upon as one of the leaders and spokesmen of the English party. A story is told that William one day taunted the English with being so easily conquered, and the English knights and nobles not being ready with an answer Frederic replied for them that the king owed the easiness of his conquest to the Church, which, by the gifts of his predecessors, held so much of the land and could not rebel against him. The king made answer that if that was the case he would not be safe from the King of Denmark, or any other who might wage war upon him, and therefore 'out of your own mouth I judge you, and I begin with you, resuming the possessions with which you are so abundantly supplied, that knights may be provided from them for the defence of the kingdom.' The king thereupon seized all the lands which the abbey held between Barnet and London to a place called 'Londonestone.'⁶⁸ Whether this story is true or not is uncertain, but there is no doubt that William did seize extensive property of St. Alban in Middlesex. Frederic was evidently the cause of suspicion with William and Archbishop Lanfranc, as one of the chief favourers of the English. It is possible that he was connected with the rebellions of Earl Waltheof, Roger Earl of Hereford and Ralph Earl of Norfolk in 1075-6, for Wulfstan Bishop of Worcester, who had taken part against the earls, offered to make peace between him and the king and Lanfranc. The abbot, however, fearing treachery and that he might be imprisoned or put to death, in 1077 suggested to the chapter that he should flee from his persecutors. By the licence and advice, therefore, of the convent he fled to the Isle of Ely, where a few days afterwards he was taken ill and died.⁶⁹

AFTER THE CONQUEST

A new era was introduced by the appointment as abbot of Lanfranc's kinsman Paul,⁷⁰ an energetic

⁶⁵ *Gesta Abbat.* i, 47.

⁶⁶ *Anglo-Sax. Chron.* (Rolls Ser.), i, 339.

⁶⁷ *Gesta Abbat.* i, 47.

⁶⁸ *Ibid.* 49, 50. William of Malmesbury (*De Gestis Regum Anglorum* [Rolls Ser.], ii, 349-52) mentions Frederic's presence at the council of 1072.

⁶⁹ *Gesta Abbat.* i, 50, 51.

⁷⁰ *Ibid.* 51. Some said he was Lanfranc's son.

RELIGIOUS HOUSES

ruler with the Norman instinct for organization and love of order. He rebuilt the monastery and church with the bricks of the ruined Roman city collected by the former abbot,⁷¹ and, what was more important from the Norman point of view, converted a careless and ill-regulated convent into a model community.⁷² The Benedictine rule was more strictly enforced with the emendations made by Lanfranc for Bec. Thus the eating of meat was discontinued; in the infirmary it was seldom allowed, and in the case of monks who were bled a kind of fish pie was substituted for the accustomed meat diet; dress was reformed; silence had to be kept in the church, cloister, frater and dormitory; discipline was enforced in the infirmary; and measures were taken to ensure due attention at the nocturnal services.⁷³

The changes were introduced gradually, so as not to excite rebellion, probably until Paul, by making a dark and strong dungeon,⁷⁴ had the means to coerce the refractory. The nuns—for, as already stated, St. Albans was a double monastery—were confined by him to the almonry and its neighbourhood, and regulations were made for them as to clothing, food, exercise, observance of silence and attendance at divine worship.⁷⁵

A lover of learning, Paul founded a scriptorium at the abbey, in which books could be made for the convent.⁷⁶ This was a beginning, perhaps, of that great school of history on whose works we largely depend for our knowledge of the 12th and 13th centuries. It was endowed with tithes in Hatfield, given by a Norman noble for this purpose, and others in Redbourn; while for greater convenience the abbot arranged that the almoner and cellarer should provide daily food for the copyists whom he brought from abroad. Not the least of his benefactions to the church were the twenty-eight volumes, besides service books of all kinds, which he presented.⁷⁷

At the back of Paul almost throughout his abbacy was Lanfranc, the value of whose support can perhaps hardly be overestimated. To the archbishop the abbey undoubtedly owed the Conqueror's two charters,⁷⁸ one granting to St. Albans sac and soc, tol and team, and all customs that Stigand⁷⁹ had in Edward the Confessor's time, the other ordering that the abbot and convent should have all the lands, churches and tithes of which they could prove seisin at

the time that William became king. The second must have facilitated the recovery by Paul of the abbey's lost possessions. The restoration of Redbourn by Lanfranc was almost a matter of course,⁸⁰ but Childwick, 'Cnicumba,'⁸¹ the land at Napsbury, Eywood and 'Tiwa' were also regained.⁸²

The respect which the abbey at this time inspired is seen in the many donations made to it,⁸³ and in the foundation and endowment of cells of St. Albans at Hertford by Robert de Limesi, Wallingford (co. Berks.) by Robert Doyley,⁸⁴ Belvoir (co. Lincoln) by Robert de Toden, Tynemouth (co. Northumb.) by Robert Mowbray, and Binham (co. Norfolk)⁸⁵ by Peter de Valognes. It had become famed far and wide for its strict observance of the rule.⁸⁶ If the result excites admiration, some pity cannot but be felt for the English monks during the process. The path of reform must have been doubly hard for men under the rule of an alien with little sympathy for the conquered race. Abbot Paul destroyed the tombs of his predecessors, whom he habitually spoke of as fools and blockheads, and although his scorn was probably for their lack of rule, he conveyed the impression that it was largely for their nationality.⁸⁷ His neglect in one instance to show a little friendly courtesy to a landholder because he was English is said to have cost St. Albans an estate which was secured by Ramsey.⁸⁸

After Paul's death in November 1093 St. Albans remained without an abbot for more than three years, that its property might be wasted by the king.⁸⁹ Within the abbey itself there seems to have been a struggle for mastery between the English and Norman sections of the convent; but all hopes of the former for predominance were crushed by the appointment of a second Norman Superior.⁹⁰ Richard de Albini, the new abbot, was apparently well chosen. Of noble birth, he made

⁸⁰ Lanfranc was very generous to St. Albans. He gave 1,000 marks to the rebuilding of the church, vestments and plate, and bequeathed to the abbey £100, of which, however, it only received £50 (Cott. MS. Nero, D vii, fol. 86).

⁸¹ By Robert Bishop of Lincoln, who left the abbey at his death £46 (*ibid.*).

⁸² Odo remitted payment of the £20 promised him for the land (*ibid.* 86*b*).

⁸³ *Gesta Abbat.* i, 56-7.

⁸⁴ The foundation of the cell is attributed in the *Gesta* (i, 56) to Abbot Paul, but it was made possible by Doyley's gifts (*V.C.H. Berks.* ii, 77).

⁸⁵ *Gesta Abbat.* i, 57. It is doubtful, however, whether this priory was founded in Paul's time (*V.C.H. Norfolk*, ii, 343).

⁸⁶ *Gesta Abbat.* i, 52.

⁸⁷ *Ibid.* 62.

⁸⁸ *Ibid.* Yet it was an Englishman, Lyulph, who presented two great bells for the tower (*ibid.* 61).

⁸⁹ *Ibid.* 65.

⁹⁰ *Ibid.* 66.

⁷¹ *Gesta Abbat.* i, 52.

⁷² *Ibid.* 59-61.

⁷³ A lantern was carried round the quire to rouse the lazy and sleepy.

⁷⁴ *Gesta Abbat.* i, 60.

⁷⁵ *Ibid.* 59.

⁷⁶ *Ibid.* 57-8.

⁷⁷ *Ibid.* 58.

⁷⁸ *Matt. Paris, Chron. Maj.* vi, 33-4. The first was granted at the prayer of Lanfranc, to the other Lanfranc was a witness.

⁷⁹ See above.

A HISTORY OF HERTFORDSHIRE

good use of the opportunities arising from the circumstance to benefit his house. William Rufus is said to have been on friendly terms with him,⁹¹ as was Henry I, who showed marked favour to the abbey in his time. This king wore his crown here one Whitsuntide⁹²; on another visit to the monastery in 1104 he granted to the abbey an annual fair to last eight days.⁹³ He also kept Christmas here in 1115,⁹⁴ and was present three days later with his queen and son at the dedication of the conventual church⁹⁵ by Robert Bishop of Lincoln,⁹⁶ and gave to the monastery Biscott in the soke of Luton.⁹⁷ During Richard's abbacy the abbey received numerous gifts, among its special benefactors being William de Albini, the king's butler, and Henry de Albini with his brothers Nigel and William.⁹⁸ In some of the transactions with regard to the property of the abbey which appeared to be disadvantageous to the house Abbot Richard was believed to have furthered his relatives' interests at the abbey's expense, and one grant was made against the will of the whole convent.⁹⁹ Yet his motives may have been wrongly suspected. It is not impossible that the surrender of Tewin¹⁰⁰ was the price paid for William Rufus's amity, and that of Sarratt¹ to Peter,

butler of William Count of Mortain, a return for services rendered to the abbey. Richard is said to have first subjected St. Albans to the jurisdiction of the Bishop of Lincoln that he might control his monks more strictly,² but how far the statement can be accepted is doubtful.³ Possibly he maintained unusually close relations with the bishop in the interests of discipline. The high repute of the abbey was at any rate maintained under him. That is evident from the profession here of Robert Mowbray Earl of Northumberland,⁴ the choice of Bernard, one of the convent, in 1202-3 to be Abbot of Ramsey,⁵ and the subjection of the priories of Wymondham and Hatfield Peverel to St. Albans⁶ by their founders, William de Albini and William Peverel. The abbot, whose withered arm had been miraculously restored at the translation of St. Cuthbert, built a chapel in honour of the saint at St. Albans.⁷ His gifts to the church included two shrines, one adorned with golden images, several precious vestments and a missal used for early mass.⁸

Richard died in 1119, and Geoffrey de Gorham became abbot by the monks' unanimous choice.⁹ He was a native of Maine, who had been summoned over by Abbot Richard to take charge of the school at St. Albans¹⁰; but when he arrived the post was already filled, so he retired to Dunstable to wait for the next vacancy. While there he borrowed from the abbey some choral copes for a performance of the miracle play of St. Katharine,¹¹ and a fire breaking out in his house they were destroyed. The accident determined Geoffrey's career. In place of the lost vestments he made an offering of himself to God and took monastic vows at St. Albans.¹² His course as abbot befitted the circumstances of his profession. A very real devotion was expressed not only in gifts to the

⁹¹ *Gesta Abbat.* i, 66. He sent a brief to the sheriffs on the abbot's behalf (Matt. Paris, *Chron. Maj.* vi, 35).

⁹² *Reg. Palat. Dunelm.* (Rolls Ser.), iii, 52. It was on this occasion that he restored Ralph Flambard's lands to him, so that the date is possibly 1101.

⁹³ *Cal. Chart. R.* 1300-26, p. 20. The charter is dated at St. Albans and is witnessed by Waldric the chancellor, who held office in 1104.

⁹⁴ *Anglo-Sax. Chron.* (Earle and Plummer), i, 246. The chronicler begins the year at Christmas and therefore dates the visit 1116.

⁹⁵ *Gesta Abbat.* i, 71.

⁹⁶ The author of the *Gesta* says that Geoffrey Archbishop of Rouen consecrated the church. Apparently he was to have performed the ceremony, but the state of his health made assistance necessary, and in the end it was the Bishop of Lincoln who actually officiated (Matt. Paris, *Chron. Maj.* ii, 142).

⁹⁷ Matt. Paris, *Chron. Maj.* vi, 36-7; *V.C.H. Beds.* ii, 361.

⁹⁸ *Gesta*, i, 67-8; Cott. MS. Nero, D vii, fol. 91 d., 98 d.; Raine, *Historians of the Church of York* (Rolls Ser.), iii, 54-7.

⁹⁹ *Gesta Abbat.* i, 72.

¹⁰⁰ The chronicler's story is not consistent. He first says (*ibid.* 52) that William Rufus deprived Abbot Paul of Tewin for the benefit of Hugh de Evermori, and afterwards (*ibid.* 72) that this manor and the church of Flamstead were lost by the collusion of Abbot Richard in order to provide the better for his kinsfolk.

¹ This had been granted by Abbot Paul to Robert the Mason, no doubt in payment for his labours in building the church, but had been restored to the abbey at Robert's death.

² *Gesta Abbat.* i, 72.

³ For the exemption of St. Albans see below.

⁴ Matt. Paris, *Chron. Maj.* vi, 372. He could not have taken the vows before 1095, so much is certain.

⁵ *Ramsey Chartul.* (Rolls Ser.), i, 237-8.

⁶ *Gesta Abbat.* i, 67. A small cell of St. Albans was also established at Millbrook (co. Beds.), but was soon absorbed by Beaulieu (*V.C.H. Beds.* i, 351).

⁷ *Gesta Abbat.* i, 70. An altar of Frosterly marble, now the top of a tomb in the south aisle of the saint's chapel, is by tradition the altar belonging to this chapel.

⁸ *Ibid.*

⁹ *Ibid.* 73.

¹⁰ For the St. Albans School see *V.C.H. Herts.* ii, 47-69.

¹¹ The church of St. Mary, Rickmansworth, was assigned by him when abbot, for the repair of ornaments, to the sacrist who had to render his accounts and give a feast to the convent on St. Katharine's Day (*Gesta Abbat.* i, 75).

¹² *Ibid.* 73.

RELIGIOUS HOUSES

church of ornaments and vestments, many and costly as these were,¹³ but in all his actions.

There was great activity at the abbey at this time. A guest-hall, apartments for the queen, the infirmary and its chapel were built.¹⁴ An elaborate shrine was begun in 1123,¹⁵ and on 2 August 1129 the body of St. Alban was translated in the presence of four abbots besides Geoffrey, and of Alexander Bishop of Lincoln,¹⁶ who gave an indulgence of forty days to all visiting the abbey on the feasts of the Invention or Translation.¹⁷

The hospital of St. Julian for lepers was founded and endowed by the abbot from a laudable desire to atone for omissions of prayers and alms due from the abbey for its benefactors.¹⁸

Probably a similar motive caused the establishment of the nunnery at Sopwell,¹⁹ and this priory, always closely connected with St. Albans, was intended to compensate for the removal from the abbey of the sisterhood, to which there is no reference after Abbot Paul's time. By the *Gesta* Geoffrey is credited also with the foundation of Markeyate Priory, but with how much truth is doubtful,²⁰ though it is unnecessary to reject entirely the story of the abbot's friendship for the saintly recluse Christina, and their benefits to each other.²¹ Geoffrey was concerned, too, with the formation of the convent at Beaulieu, which became a cell of the abbey.²²

No relaxation of the rule was permitted at St. Albans under this abbot.²³ He insisted on silence at meals in the infirmary, on abstinence from meat unless such food was needful for health, and on the return to the cloister of the monks as soon as they had recovered from illness. Yet he was anything but a hard man. It was he who assigned the church of St. Peter

to the infirmary to provide necessaries for the sick and old; by him, too, the sums allotted for the convent's food and for alms were increased.²⁴ He was moreover very charitable.²⁵ During a famine²⁶ he had the partly completed shrine stripped of its precious covering to obtain means to feed the poor.²⁷

Such information as there is about the monks is all favourable to them. The shrine was made by an inmate of the house, Anketil, at one time moneyer to the King of Denmark.²⁸ Walter Abbot of Eynsham, present at the Translation in 1129, was an ex-prior of St. Albans²⁹; and another prior, Godfrey, was made Abbot of Crowland by the Council of Westminster in 1138.³⁰ It is specially noted that the foundation of St. Julian's had the approval of the whole community.

Geoffrey was succeeded in 1146 by Ralph Gubiun, whose election received the assent of the king when visiting the abbey on Ascension Day.³¹ Ralph had been chaplain and treasurer to Alexander Bishop of Lincoln, with whom he had remained even after he had become a monk. The bishop had promised to make him abbot³² and possibly directed the convent's choice. A consciousness that the election had not been quite free would certainly explain the abbot's extreme uneasiness at finding an uncut seal on Anketil's table. Suspecting the prior of a plot to depose him, he removed him from office, and drove him at last to seek refuge from persecution with the Abbot of Westminster.³³ He is said to have protected his church manfully,³⁴ possibly a reference to some special occasion for his journey to France to obtain from Pope Eugenius III a bull similar to that of Celes-

¹³ *Gesta Abbat.* i, 74-5.

¹⁴ The Bishop of Lincoln's ordinance in 1129 that 300 poor people should be fed at the monastery on the festival of the Invention was made by the abbot's counsel and assent (*ibid.* 92).

¹⁵ There was scarcity in 1124 and 1125 (*Anglo-Sax. Chron.* [Earle and Plummer], i, 254, 256).

¹⁶ *Gesta Abbat.* i, 82. The same feeling doubtless prompted the sacrifice of a reredos to save the town from being burned by Stephen's followers (*ibid.* 93-4), apparently in 1142 (*Matt. Paris, Hist. Angl.* i, 270-1).

¹⁷ *Gesta Abbat.* i, 80. Most beautiful work was done also in the scriptorium, to judge from a specimen still remaining (Herbert, *Illum. Manuscripts*, 136).

¹⁸ *Gesta Abbat.* i, 85.

¹⁹ *Chron. of reigns of Stephen, Henry II and Richard I* (Rolls Ser.), iii, 175. In the *Gesta Abbat.* (i, 120-1) Godfrey is said to have been appointed in the time of Abbot Robert de Gorham (1151-68) at the wish of Alexander Bishop of Lincoln, who, it should be remarked, died in 1148.

²⁰ *Matt. Paris, Hist. Angl.* i, 276-7.

²¹ *Gesta Abbat.* i, 106.

²² *Ibid.* 107-8.

²³ *Ibid.* 106.

²⁴ Among other things he presented 7 beautiful copes, 5 chasubles (one of which was afterwards burned for the sake of its gold), 3 albs, a tunic, a gold chalice and paten, a reredos for St. Alban's altar of gold, silver and gems, a silver-gilt censer, several books, a great hanging, on the gold ground of which was woven the Invention of St. Alban, and 2 smaller tapestries (*Gesta Abbat.* i, 93-4).

²⁵ *Ibid.* 79.

²⁶ *Ibid.* 80.

²⁷ *Ibid.* 85.

²⁸ *Ibid.* 92.

²⁹ *Ibid.* 77-8.

³⁰ *Ibid.* 80-2.

³¹ *V.C.H. Beds.* i, 358.

³² He is said not only to have founded and endowed the priory in spite of the murmuring of his monks, but to have rebuilt it after a fire. She for her part was his adviser in spiritual matters, and by her prayers saved him several dreaded journeys (*Gesta Abbat.* i, 103-4). His influence may, in fact, have had much to do with the formation of the community and foundation of the house (*V.C.H. Beds.* i, 358).

³³ *Gesta Abbat.* i, 78; *V.C.H. Beds.* i, 351.

³⁴ *Gesta Abbat.* i, 79-80.

A HISTORY OF HERTFORDSHIRE

tine II.³⁵ His principal acts besides were the institution of a weekly procession in honour of the Virgin Mary, the building of rooms for the abbot near the church, and the purchase of Bramfield.³⁶ He left the abbey clear of all debt, but he had taken the silver-gilt plates of the shrine to pay for the new estate.³⁷ In 1150 he was attacked by an incurable disease, and it was apparently by his own wish that he was superseded.³⁸ By permission of King Stephen, who came again to St. Albans in 1151, the monks exercised their right to elect, and chose the prior, Robert de Gorham,³⁹ who received the benediction nineteen days before Ralph's death.⁴⁰

Robert de Gorham was the nephew of Abbot Geoffrey, in whose time he had transferred himself from a continental monastery to St. Albans. Here he had become secretary, and in 1149 prior.⁴¹ He made a clever, politic abbot, devoting all his powers to the aggrandisement of his house and working indefatigably for its material advancement. Early in his abbacy he took the opportunity afforded by the confusion of ownerships and overlordships under Stephen to acquire the church of Luton, with its endowment of land in 'Hertevelle,' Battlesden and Potsgrove.⁴²

A prolonged struggle with Robert de Valognes⁴³ arose from the abbot's decision to put beyond doubt the abbey's proprietary rights in Northaw Wood, endangered by the life grants of his predecessors to various members of the Valognes family.

The quarrel with the Earl of Arundel seems also to have been caused by the abbot's desire to test and substantiate claims,⁴⁴ in this instance unjust ones.⁴⁵

In both these cases the abbot was victorious,⁴⁶ but in the dispute with Westminster Abbey over Aldenham⁴⁷ he met his match. Laurence, then Abbot of Westminster, had formerly been a monk of St. Albans,⁴⁸ and on succeeding to the

abbacy had been very kindly treated by Abbot Robert. Expectations, however, that he would be bound by past ties were doomed to disappointment. He was as uncompromising and unscrupulous in support of his own house as his opponent, over whom he carried the day.

Of all Robert de Gorham's struggles that with the Bishop of Lincoln was incomparably the most important. The abbot, sent with other ecclesiastics to Rome by Henry II on the king's business, seized the opportunity to secure the abbey's independence.⁴⁹ The occasion was propitious. Pope Adrian IV, a native of Abbots Langley, had reason to be interested in St. Albans,⁵⁰ and was generous with gifts⁵¹ and privileges.⁵² By him an annual procession of clerks and laymen of the county to St. Albans was ordained, the abbey and its cells declared exempt from the jurisdiction of the Bishop of Lincoln, and the abbot authorized to wear the mitre and other pontifical ornaments. The bishop, after remonstrance, agreed to the procession,⁵³ but the abbey's exemption he refused to recognize, and when Pope Adrian was dead⁵⁴ contested the point.⁵⁵ The abbot is said to have convinced the king that Adrian had not given but *restored* freedom to St. Albans, though it seems probable that no exemption existed before this date.⁵⁶ However, as the submission of the house to the see of Lincoln at any rate at one period⁵⁷ was an undeniable fact, Robert came to an agreement with the bishop, and in March 1163 made over to him the manor of Fingest (co. Bucks.)⁵⁸ in return for a renunciation of all episcopal rights over the monastery.⁵⁹

⁴⁹ *Gesta Abbat.* i, 126-9.

⁵⁰ His father took vows there (*ibid.* 124-5). The story of his own attempted profession at St. Albans and its frustration by Abbot Robert is obviously fictitious, for he became Cardinal of Albano in 1146 after a residence of some years on the Continent.

⁵¹ He gave the abbey relics of the Theban Legion, a beautiful silk cloth sent to him by the emperor, valuable sandals and ring (*ibid.* 132), and a goblet for the refectory (*Matt. Paris, Chron. Maj.* vi, 248).

⁵² *Gesta Abbat.* i, 129-30.

⁵³ *Ibid.*

⁵⁴ *Ibid.* 135-6.

⁵⁵ The question was argued first at Winchester and afterwards before the king at Westminster (*ibid.* 139-54).

⁵⁶ References to its exemption before this time are either suspicious or interpolations of a later date. The exercise of jurisdiction by the Bishop of Lincoln over St. Albans at an early period is proved by the bishop's appointment of Wulsin as abbot in the 10th century when there was a dispute in the monastery.

⁵⁷ Robert and his two immediate predecessors had been blessed by the Bishop of Lincoln and made profession of obedience to him.

⁵⁸ Compensation was offered by the king's advice (*Gesta Abbat.* i, 154-5).

⁵⁹ *Ibid.* 155-7; *Plac. de Quo Warr.* (Rec. Com.), 90.

³⁵ *Gesta Abbat.* i, 107. Pope Celestine confirmed grants past and future made to St. Albans (Cott. MS. Nero, D vii, fol. 8 d.).

³⁶ *Gesta Abbat.* i, 107-9.

³⁷ *Ibid.* 109.

³⁸ According to the *Gesta Abbat.* (i, 108) he got the monks to put the prior in his place.

³⁹ *Matt. Paris, Chron. Maj.* ii, 187.

⁴⁰ In the *Gesta Abbat.* (i, 110) he is said to have lived some years after the appointment of his successor, obviously an error if he fell ill in the fourth or the beginning of the fifth year of his rule and died 5 July 1151.

⁴¹ *Gesta Abbat.* i, 110-11.

⁴² *Ibid.* 113-19; *V.C.H. Beds.* ii, 356.

⁴³ *Gesta Abbat.* i, 159-66.

⁴⁴ *Ibid.* 166-75.

⁴⁵ *V.C.H. Norfolk*, ii, 336-7.

⁴⁶ Partly owing to his energy and pertinacity.

⁴⁷ *Gesta Abbat.* i, 134.

⁴⁸ *Ibid.* 159.

RELIGIOUS HOUSES

St Albans was recognized as first among the English abbeys at the Council of Tours in 1163.⁶⁰

In his relations with his monks Robert managed to combine a kindly ease in ordinary intercourse with a somewhat severe dignity in chapter.⁶¹ He is said never to have refused alms to the poor. He left the abbey 600 marks in debt,⁶² and this is hardly surprising, considering the expenditure necessitated by suits and processes,⁶³ a considerable amount of building⁶⁴ and the work on the shrine destroyed by his predecessors.⁶⁵

The assent of the king to the election of another abbot was withheld for more than four months.⁶⁶ Then out of three monks selected by the convent he chose Simon, the prior, who received the benediction from the Bishop of London 20 May 1167.⁶⁷ Simon loved learning and was anxious to encourage it in the cloister. The increase of the library was therefore his particular care.⁶⁸ He not only repaired and reformed the scriptorium,⁶⁹ but kept two or three picked writers at work in his own room,⁷⁰ and had an aumbry or cupboard made in which books could be kept.⁷¹

It is related that he was an intimate friend and admirer of Archbishop Thomas, and earned his grateful thanks by interceding on his behalf with the young king at great personal risk.⁷² The archbishop's murder seems to have turned the abbot's thoughts to their own martyr, for his work on the magnificent outer shrine of St. Alban is said to date from that time.⁷³ Prudence perhaps would have suggested its

postponement until finances had recovered from the strain of Abbot Robert's expenses. The convent incurred obligations which it had great difficulty in discharging. Aaron the Jew, indeed, told the monks to their faces that St. Alban owed his shrine to him.⁷⁴ Yet whatever they suffered in their endeavours to honour the saint must have appeared rewarded by the discovery in 1178 of the relics of St. Amphibalus, the instructor of St. Alban in the Christian faith.⁷⁵ An inhabitant of the town, a devout worshipper of St. Alban, was led one night by the saint himself to Redbourn and shown where St. Amphibalus and his companions lay buried. The abbot was told, and excavations were made at the place indicated, with the result that the holy remains were found. As the relics were on their way to the monastery, they were met by a procession of monks bearing the shrine of St. Alban, who testified by miracles his joy at the encounter.

When Simon died the choice of the whole convent, with one exception, fell upon a Cambridgeshire monk called Warin.⁷⁶ The dissident⁷⁷ objected on the ground that Warin was almost blind, and that the burgher stock of which he came cared only for money, and prophesied that he would oppress the brothers.⁷⁸ The objector's judgement was perhaps better than his motives. The abbot helped a horde of relatives at the monastery's expense.⁷⁹ He was very self-willed, and his brother, whom he soon made prior, very suspicious.⁸⁰ The result was that the older monks were slighted in favour of the younger, and opposition of any kind was treated as rebellion and punished by banishment to the more distant cells.⁸¹ The example given of the abbot's obstinacy is his foundation of the hospital of St. Mary de Pré without regard to remonstrances.⁸² It is easy to see the convent's objection to impoverishing their own house to endow another. On the other hand, to the abbot, who believed he was acting in their best interests, they may well have appeared factious. Apart from the obedience due to the vision commanding honour to be paid to the place where the relics of St. Amphibalus and St. Alban had met, expediency urged the commemoration of the miracles which had there attested the genuineness of the remains inclosed

⁶⁰ But the Abbot of Bury St. Edmunds usurped Robert's place (*Gesta Abbat.* i, 177-8).

⁶¹ *Ibid.* 180.

⁶² *Ibid.* 183.

⁶³ The abbot gave the king £100 to have his case over Northaw Wood submitted to the justiciar (*ibid.* 164), and offered him the same sum during his contest with the Bishop of Lincoln (*ibid.* 146).

⁶⁴ The chapter-house, royal parlour with the chapel of St. Nicholas, part of the cloister, a lavatory, stable, &c. (*ibid.* 179).

⁶⁵ *Ibid.*

⁶⁶ *Ibid.* 183.

⁶⁷ *Ibid.* 184.

⁶⁸ *Ibid.*

⁶⁹ *Ibid.* 192. One of the books he had made, a copy of the Homilies of St. Gregory the Pope with illuminated initials, is now in the library of Stonyhurst College (*Hist. MSS. Com. Rep.* ii, App. ii, 144); another, a beautifully written 'Polycricon,' is in the British Museum (*Matt. Paris, Hist. Angl.* [Rolls Ser.], Introd. p. xi).

⁷⁰ Simon is believed by some to have created the office of historiographer at St. Albans (Hardy, *Descriptive Cat. of Materials for Hist. of Britain* [Rolls Ser.], iii, p. xxxiv).

⁷¹ *Gesta Abbat.* i, 184.

⁷² *Ibid.* 184-6.

⁷³ *Ibid.* 189.

⁷⁴ *Gesta Abbat.* i, 193-4.

⁷⁵ *Ibid.* 192-3; *Chron. Maj.* ii, 301-8.

⁷⁶ *Gesta Abbat.* i, 194-5. He was noted before he became a monk for his good life and learning. He and his brother Matthew both studied medicine at Salerno.

⁷⁷ William Martel, the sacrist.

⁷⁸ *Gesta Abbat.* i, 194-5.

⁷⁹ *Ibid.* 216.

⁸⁰ *Ibid.* 196, 215.

⁸¹ *Ibid.* 215-16.

⁸² *Ibid.* 215.

A HISTORY OF HERTFORDSHIRE

in St. Alban's shrine : for on this point there had certainly been uneasiness.⁸³

Warin's mitigation of the severity of the rule was no doubt popular. Services were shortened⁸⁴; on fast days the monks were allowed to sleep after dinner⁸⁵; those who had been bled were excused attendance at certain services⁸⁶; the eating of meat was no longer so restricted⁸⁷; Redbourn was made a health resort where the routine of the cloister could be relaxed for a short time.⁸⁸ One or two alterations were made in dress for greater decorum : henceforth monks were not to serve at dinner without their frocks when seculars were present⁸⁹; as soon as novices had received the tonsure they were to wear the monastic habit⁹⁰; boots were to be worn instead of shoes, the fastenings of which caused inconvenience.⁹¹

Warin was zealous in maintaining the abbey's liberties. When Walter de Coutances, as Bishop of Lincoln (1183-6), would have called the monastery's exemption in question, the abbot appealed to the king and thus stopped the discussion.⁹² For better assurance he procured in 1188 a confirmation of the pact with Lincoln from Clement III and other bulls concerning the abbey's freedom.⁹³ Warin seems to have made a point of ingratiating himself with King Richard and the queen mother⁹⁴ and succeeded,⁹⁵ though not without expense. John de Cella, the Prior of Wallingford, who succeeded him in 1195, was a learned⁹⁶ and

devout man, but he had little capacity for temporal affairs which he committed largely to others.⁹⁷ Possibly his unlucky experiences in building induced this course. Warin had left 100 marks⁹⁸ to renew the front of the church, which was accordingly pulled down. But misfortune seemed to dog the work.⁹⁹ The builder first put in charge proved untrustworthy, and when one of the brothers was given the superintendence and a portion of the monastery's income was set apart for the work, the rate of progress was still very disappointing. The rebuilding of the refectory was not attended by so much difficulty and was finished in John's abbacy; and a new dormitory¹⁰⁰ was also begun.

A great deal of trouble was caused to the abbey at this time by Robert Fitz Walter. As the husband of Gunnora de Valognes he revived the Valognes' claim to Northaw Wood and persuaded a discontented and unscrupulous monk, William Pygun by name, to attach the conventual seal to a forged charter in his favour.¹ The abbot's desire to hush up the matter saved Pygun from any punishment but transference to Tynemouth Priory,² and perhaps operated to the benefit of Fitz Walter, who received Biscott in return for Northaw. Later there was a quarrel over Binham Priory, a Valognes foundation,³ and Fitz Walter is said to have relied again on a forged document. Failing in his lawsuit, he tried to take possession of the priory by force, but the king sent to its relief. For John's help the abbot and convent had to thank his hatred of Fitz Walter. They had personally little reason to be grateful to him. At the beginning of his reign, it is true, he had shown them favour : on 28 May 1199, the day after his coronation, he visited St. Albans and made offerings⁴; in June he confirmed his father's charter of liberties⁵; in August he granted them, moreover, a weekly market in Barnet.⁶ They were not excepted, however, from the bad treatment meted out to the religious generally during the Interdict. On 29 March 1208 the custody of the house was committed to a clerk named Robert de London,⁷ who appointed his own

⁸³ In Geoffrey's abbacy doubt was expressed by an assistant worker on the shrine, but was allayed by the saint appearing to Anketil and promising to reward his labour (*Gesta Abbat.* i, 87). It is evident that the question recurred at intervals, and was not settled by the verdict against Ely following an inquiry made by the pope's orders at the request of Abbot Robert de Gorham (*ibid.* 175-6). Nor in truth, whatever Warin hoped, was the triumph of St. Albans assured by the Invention of St. Amphibalus. Discussion still went on in the 13th century, and it was a monk of Matthew Paris's time who remained unconvinced until one night he saw St. Alban issue from his shrine and heard him declare who he was (*ibid.* 37).

⁸⁴ *Ibid.* 212-13. ⁸⁵ *Ibid.* ⁸⁶ *Ibid.* 207-9.

⁸⁷ Monks who were delicate might eat meat in the oriel (*ibid.* 211).

⁸⁸ *Ibid.* ⁸⁹ *Ibid.* 214. ⁹⁰ *Ibid.*

⁹¹ Such as soiling the monks' hands (*ibid.* 211).

⁹² *Ibid.* 197-8. The king and bishop were then visiting the abbey.

⁹³ *Matt. Paris, Chron. Maj.* vi, 43, 53-61.

⁹⁴ *Gesta Abbat.* i, 216. He sent Richard a handsome present on his return to England (*Matt. Paris, Hist. Angl.* ii, 47).

⁹⁵ Roger de Hoveden, *Chron.* (Rolls Ser.), iii, 212; *Matt. Paris, Chron. Maj.* ii, 403.

⁹⁶ He could be considered a Priscian in grammar, an Ovid in verse, and a Galen in medicine (*Gesta Abbat.* i, 217). He had a marvellous memory, and was able to repeat the whole psalter backwards (*ibid.* 232).

⁹⁷ *Gesta Abbat.* i, 218.

⁹⁸ *Ibid.* 215.

⁹⁹ *V.C.H. Herts.* ii, 484-5.

¹⁰⁰ To raise money for this building the convent gave up its wine for fifteen years (*Gesta Abbat.* i, 220).

¹ *Ibid.* 221-4. Pygun had a grudge against the abbot for refusing to receive his nephew as a monk.

² Here he had a horrible end. Retiring to the cloaca one night to gorge himself undisturbed with food and drink, he fell into a drunken sleep and so died (*ibid.* 224).

³ *Ibid.* 226-8; *V.C.H. Norfolk*, ii, 344.

⁴ *Matt. Paris, Hist. Angl.* i, 81.

⁵ Dugdale, *Mon.* ii, 231.

⁶ *Cal. Rot. Chart.* 1199-1216 (Rec. Com.), 11b.

⁷ *Rot. Lit. Pat.* (Rec. Com.), 81a.

RELIGIOUS HOUSES

doorkeeper and cellarer and made his hand so much felt that the abbot paid 600 marks to be free of him.⁸ In the same year the king by Richard Marsh demanded an aid of 500 marks, which the abbot dared not refuse.⁹

The abbot fell ill in 1214, and, knowing his end was near, had himself helped into the chapter-house, where he begged the convent's pardon for his offences and insisted on receiving discipline from all. When he had bidden them farewell, he was carried to his room, and there he died three days later, as he had predicted from his symptoms.¹⁰ Good and pious¹¹ as he undoubtedly was, he was perhaps not an ideal abbot. He seems to have depended too much on advisers, who were not always well chosen. Roger de Hertfort, John de Seldford and Alexander de Langley were flatterers and mischief-makers, and by their means, sometimes without the abbot's knowledge, monks who had committed no fault were removed from St. Albans to the cells and from one cell to another.¹² Sometimes, of course, the banished had only themselves to blame for their sentence. When Walter de Standune, Almaric and others accused the abbot to the papal legate of buying land for a kinsman with the church's money,¹³ they must have known it meant his removal¹⁴ or theirs.

When Abbot John was on his death-bed Alexander de Langley joined Walter de Rheims and William de Trumpington in begging him to seal a charter prohibiting such transference at the abbot's will. The dying man, unable to speak, refused by a sign, but notwithstanding the keeper of his seal, Alexander de Appelton, sealed the deed.¹⁵

After a vacancy of four months William de Trumpington was elected, partly through outside influence.¹⁶ A complete contrast to his predecessor, William found his sphere in the active not the contemplative life. His strength lay in governing and organizing. Of a buoyant disposition, he was undaunted by any misfortunes and equal to all emergencies. During the war the abbot needed all his strength of

nerve. His refusal to do homage to Louis was met by a threat to burn the town and abbey, and destruction was only averted by a money payment.¹⁷ The immunity purchased from one side was the incentive to attack by the other. Falkes de Breauté swooped down on St. Albans on 22 January 1217, and after ill-treating and robbing the inhabitants, demanded £100 as ransom of town and monastery.¹⁸ On 30 April the abbey was in danger from French mercenaries,¹⁹ but again escaped, though it was swept bare of all stores. The anxieties of the abbot may be measured to some extent by the losses of his house, which were estimated at £2,555.²⁰ Meanwhile a trial of strength had been going on in the abbey itself. Those responsible for William's election soon repented their choice,²¹ in some instances no doubt because hopes of their own predominance were disappointed. His constant association with laymen gave offence, and he was twice reprovved in chapter for his conduct and for breaches of the charter he had made. The first time he promised amendment,²² but when accused the second time²³ he threw himself into a violent rage, and said that in making the charter he had not known what he was doing²⁴ and that he did not mean to be bound.²⁵ The excitement was so great that he agreed to consider the question, but evidently only to gain time. By his secret request the papal legate²⁶ came to the abbey and asked to see the charter. When he had read it he tore it to pieces, afterwards telling the abbot to send for him if he had any more trouble. William, now supreme, disposed of the leaders of the opposition. Raymond, the prior, of whom he was probably jealous and afraid,²⁷ he banished to Tynemouth; he also

¹⁷ *Gesta Abbat.* i, 259.

¹⁸ *Ibid.* 267, n. 3. Frightened by a dream he afterwards professed penitence at St. Albans, but made no restitution (*ibid.* 268).

¹⁹ On their way to relieve Mountsorel Castle (*Matt. Paris, Chron. Maj.* iii, 15-16).

²⁰ *Gesta Abbat.* i, 298. The sums of money paid to various people amounted to £950.

²¹ *Ibid.* 254. ²² *Ibid.* 255. ²³ *Ibid.* 256.

²⁴ In other words, he had been unaware that he was tying his own hands.

²⁵ *Ibid.*

²⁶ *Ibid.* 257. The papal legate who intervened in John de Cella's time is said to have been Gualo, and on this occasion Nicholas, but this must be a mistake, for Nicholas preceded Gualo as legate. If, as seems probable, the names have been accidentally transposed, the first incident took place in 1213-14 and the latter between May 1216 and 1218.

²⁷ Matthew Paris says (*ibid.* 258) there was in those times no greater monk in the order than Raymond. The prior had busied himself under Abbot John in adding to the library, chief among his acquisitions being the 'Historia Scholastica' of Peter Comestor (*ibid.* 233).

⁸ *Gesta Abbat.* i, 241-2.

⁹ *Ibid.* 242-3. ¹⁰ *Ibid.* 245-6.

¹¹ The belief in his holiness is shown by the story that his attendants having fallen asleep on one occasion while he was singing nocturns, the responses were made by angels (*ibid.* 230-2).

¹² *Ibid.* 251. ¹³ *Ibid.* 252.

¹⁴ John explained that he had given the convent the equivalent of the money, and was exculpated by the legate.

¹⁵ Which was therefore more readily approved by the Archbishop of Canterbury (*ibid.* 247-9).

¹⁶ *Ibid.* 250. William's kinsman, the steward of Saer de Quency, worked hard for him at court, and the convent believed that the king would accept no one else as abbot.

A HISTORY OF HERTFORDSHIRE

exiled Almaric, Walter de Standune and John de Seldford,²⁸ and rid himself of Alexander de Langley by promotion.²⁹

When the abbot had ensured his position he showed himself in a different and better light. The conclusion of wars internal and external was followed by a visitation of the cells.³⁰ At three out of eight priories, Belvoir, Wymondham and Hatfield, the priors were unsatisfactory. The abbot confined himself at first to admonition, but as the delinquents did not amend he removed them.³¹

In 1218 the abbot obtained from Honorius III papal protection for the monastery, its property and cells, and confirmation of all the privileges of St. Albans.³² The next year he brought about a settlement of certain disputed points with the Bishop of Lincoln,³³ particularly in relation to the cells of Belvoir, Hertford and Beaulieu.³⁴ An agreement of a similar kind was made in 1228 with the Bishop of Norwich as to the priories of Wymondham and Binham.³⁵ When circumstances permitted, William turned his attention to the improvement of the fabric and ornaments. Here much was done.³⁶ The dormitory was finished, part of the church roofed, the tower heightened and repaired,³⁷ cloisters were made on the south side, altars to St. Mary and St. Wulfstan constructed, the chapel of St. Cuthbert rebuilt, and the west front at last completed.³⁸ All this necessitated heavy expenditure. In 1229 the king's protection was given, apparently in May when Henry was at the abbey,³⁹ to those sent from

St. Albans to collect money for the repairs by preaching and begging,⁴⁰ and in October royal letters were directed on the abbot's behalf to his men for help to pay his debts.⁴¹ For decorative work William had an artist at hand in Walter de Colchester, the sacrist, an accomplished sculptor and painter⁴² who had already given proof of his ability in John de Cella's time.⁴³ His fame was not limited to St. Albans, for he was employed at Canterbury on the shrine of St. Thomas.⁴⁴ Walter established a school of painting at St. Albans, which flourished for a century.⁴⁵ The abbot was punctilious in the performance of his religious duties, and well-informed on all matters relating to divine service.⁴⁶ The changes he introduced testify to his love of beauty and order in religious observances. He ordained a daily mass of St. Mary 'cum nota'⁴⁷ for which he made careful arrangements⁴⁸; he added several lights⁴⁹; and appointed that the daily private service of All Saints should be said in the quire, and not interrupted by processions.⁵⁰

His recorded acts of administration were very sensible. Thus he purchased a hostel in London for lodging himself and his monks when necessary,⁵¹ and a house at Yarmouth for storage of fish bought as occasion offered.⁵²

If William de Trumpington was not without faults, he was a commendable and exceedingly able abbot, probably the best that the monastery could have had at that time, when it needed a strong rule. Whatever may have been the feeling towards him at the beginning of his abbacy,

²⁸ *Gesta Abbat.* i, 260.

²⁹ At the request of the Earl of Arundel, Alexander was made Prior of Wymondham. He had, however, soon to be recalled to the abbey on account of mental aberration. There he recovered for a time and was made keeper of the abbot's seal, for he was very clever at composition. But he went mad again, and with the cruelty always shown to the insane in those days he was whipped in chapter and sent to Binham Priory to be kept in chains till he died (*ibid.* 266).

³⁰ *Ibid.* 270-3.

³¹ *Ibid.* 274-5.

³² Dugdale, *Mon.* ii, 232.

³³ *Gesta Abbat.* i, 275-7. One of these was the ordination of a vicarage in Luton Church.

³⁴ The abbot alone was to have authority in these cells, but the priors on appointment were to be presented to the bishop and do canonical obedience for the spiritual administration received from him.

³⁵ *Gesta Abbat.* i, 278-9.

³⁶ *V.C.H. Herts.* ii, 485.

³⁷ Under the direction of Richard de Tyttenhanger, lay brother and chamberlain. After his death the tower was embellished at the suggestion of Matthew de Cambridge, keeper of the abbot's seal, who managed the alterations connected with the new altar of St. Mary (*Gesta Abbat.* i, 280, 285).

³⁸ *Ibid.* 280-8.

³⁹ *Cal. Pat.* 1225-32, p. 252.

⁴⁰ *Cal. Pat.* 1225-32, p. 252.

⁴¹ *Ibid.* p. 273.

⁴² For his works see *V.C.H. Herts.* ii, 485.

⁴³ He engraved the silver-gilt covers of two copies of the Gospels and painted pictures for the altars of St. Mary, St. John, St. Stephen, St. Amphibalus and St. Benedict (*Gesta Abbat.* i, 233).

⁴⁴ *Matt. Paris, Hist. Angl.* ii, 241. The saint's translation took place in 1220.

⁴⁵ W. Page, 'The St. Albans School of Painting,' *Arch.* lviii, 278-85.

⁴⁶ *Gesta Abbat.* i, 303-4.

⁴⁷ There was already one 'sine nota.'

⁴⁸ Six monks were deputed to celebrate in rotation, and a bell called St. Mary was assigned to summon them to their office. The abbot provided the missal and all necessaries (*Gesta Abbat.* i, 284-6).

⁴⁹ A candle crowned with flowers before the image of the Virgin on the principal festivals (*ibid.* 286), and six wax candles near the shrine of St. Alban, for which a mark from Binham Priory (*ibid.* 284) and 2s. payable from Bradway (Cott. MS. Jul. D iii, fols. 65-6) were assigned. The two candles burning daily at the mass of the Blessed Mary 'sine nota' were also in his time increased to four (*Gesta Abbat.* i, 284).

⁵⁰ *Gesta Abbat.* i, 293.

⁵¹ *Ibid.* 289.

⁵² *Ibid.* 290

RELIGIOUS HOUSES

he succeeded in gaining the approbation and affection of his convent and was much lamented at his death.⁵³

The royal licence to elect was asked and given immediately,⁵⁴ and at the same time the monks negotiated successfully for the custody of the house while vacant.⁵⁵ John Prior of Hertford was chosen, most unexpectedly to himself.⁵⁶ His was the first election since the Council of Lateran had enjoined that exempt abbots must be confirmed by the pope, but as John was elderly and not strong, proctors were sent in his place.⁵⁷ Reinforced by letters of the king and his friends, their request was granted. The Bishop of London blessed the abbot, who made profession of obedience to the pope, to find that unwittingly he had bound himself to go every three years in person or by proxy to Rome. 'What should I do there?' asked the abbot; 'Make offerings, my friend,' answered the bishop.⁵⁸ St. Albans, in fact, at one time might have existed for little else. The demands of the pope never ceased. Two Franciscans visited the abbey as papal collectors in 1247,⁵⁹ and in the same year the pope required a contribution for the Earl of Cornwall.⁶⁰ In 1254 the Bishop of Norwich came to St. Albans to take the tenth granted by the pope to the king for three years.⁶¹ The Bishop of Hereford, Henry's agent at Rome, pledged the convent's credit for 500 marks on the pope's behalf,⁶² and on 9 April 1256 papal letters were sent to them to pay the money to certain merchants within a month.⁶³ Failing to discharge their obligation, they were placed under an interdict for fifteen days,⁶⁴ and of course did what they were ordered. Any treatment was considered good enough for them: the monks sent to do honour to the Archbishop of Messina, the pope's envoy, in 1257 were virtually imprisoned in his house until they paid what he wanted.⁶⁵

The monastery was also burdened through papal provisions. St. Peter's near St. Albans was claimed in 1252 by a papal nominee, but the church was proved to be appropriated and therefore not available.⁶⁶ The struggle over

Hartburn Church⁶⁷ (co. Northumberland) was not so easily determined, since the appropriation had been obtained only just before the rector's death. The case was taken to Rome, and though the abbot and convent gained their point, they had to pay the claimant 25 marks a year until they should give him a living worth 80 marks.⁶⁸

Still the proctors of St. Albans reaped some advantage from their stay at the papal court. They secured the appropriation of the churches of Wingrave (co. Bucks.) and Coniscliffe (co. Durham)⁶⁹ and many privileges,⁷⁰ besides indulgences for the benefit of their monastery.

With the pope's example before him, it is not surprising that Henry III, devout worshipper of St. Alban as he was, should have tried to exploit the house for his own ends. In his less important attempts he was successful,⁷¹ but when in 1258 he asked the abbot and convent to be surety for him for a large sum, they sheltered themselves behind the bull of prohibition of Pope Clement III,⁷² and could not be moved from their position.⁷³

The abbot had a hard task to resist the many and varied encroachments on the monastery's rights. Early in his abbacy he was harassed by Ralph de Chenduit,⁷⁴ who set him at defiance and laughed at his sentence of excommunication.⁷⁵ For years, too, he had contentions over right to free warren with the tenants of St. Albans,⁷⁶ particularly with Geoffrey de Childwick, who, strong in influence at court, hunted in the abbot's lands and maltreated his servants with impunity.⁷⁷ At last the abbot and convent had to abandon the hopeless struggle and make peace with him.⁷⁸ Geoffrey and Ralph had cost them 2,000 marks.⁷⁹

In 1249 there was another contest with Westminster Abbey over Aldenham, which was not settled until 1256.⁸⁰

A stand had also to be taken more than once for the abbey's privileges. The justices in 1254

⁶⁷ *Gesta Abbat.* i, 346-50.

⁶⁸ *Cal. Papal Letters*, i, 333-4.

⁶⁹ *Gesta Abbat.* i, 350-1.

⁷⁰ *Ibid.* 351-4. One declared that the abbey and cells could not be bound to any merchants without their common assent or the seals of their convents; another permitted them to use their liberties, statutes of legates and nuncios notwithstanding.

⁷¹ *Matt. Paris, Chron. Maj.* v, 240-1.

⁷² *Ibid.* vi, 60.

⁷³ *Ibid.* v, 684-7.

⁷⁴ *Ibid.* iv, 262.

⁷⁵ *Gesta Abbat.* i, 319.

⁷⁶ The abbot won his case against them in 1240 (*Chron. Maj.* iv, 50-4), but there was further trouble in 1248 (*ibid.* v, 27), the year in which he obtained a charter of free warren from Henry III (*Cal. Chart. R.* 1226-57, p. 330).

⁷⁷ *Gesta Abbat.* i, 315-17.

⁷⁸ *Ibid.* 319.

⁷⁹ *Ibid.* 320.

⁸⁰ *Ibid.* 361-6. See *V.C.H. Herts.* ii, 150.

⁵³ *Gesta Abbat.* i, 303.

⁵⁴ *Cal. Pat.* 1232-47, p. 95.

⁵⁵ *Gesta Abbat.* i, 306.

⁵⁶ *Ibid.* 312. The present he had brought for the new abbot fell out of his clothes in the church just after his own election.

⁵⁷ *Ibid.* 307-8.

⁵⁸ *Ibid.* 309-10.

⁵⁹ *Matt. Paris, Chron. Maj.* iv, 599-600.

⁶⁰ *Ibid.* vi, 134-8.

⁶¹ *Ibid.* v, 451-2.

⁶² *Gesta Abbat.* i, 379-82.

⁶³ *Matt. Paris, Chron. Maj.* v, 552.

⁶⁴ *Ibid.* 589-90.

⁶⁵ *Ibid.* 614.

⁶⁶ *Gesta Abbat.* i, 331-7.

A HISTORY OF HERTFORDSHIRE

summoned the men of the St. Albans jurisdiction outside the liberty, and imposed a fine of £100 for non-attendance, but the abbot brought his cause before the King's Council and the judgement was reversed.⁸¹ The point at issue between the abbot and the Bishop of Durham in 1248 and 1256-8⁸² seems to have been of this kind. Archbishop Boniface in 1258 had to be reminded that the abbey was not subject to Lincoln.⁸³

Of the convent at this time little but praise is recorded. The choice in 1247 of one of the monks, the celebrated Matthew Paris, to reform and instruct in the Benedictine rule the monastery of St. Benet Holm, Norway,⁸⁴ is testimony of the widespread relations and high reputation of St. Albans.⁸⁵

At the end of October 1251 a visitation of the abbey was made by the Prior of Hurley and the Sub-prior of St. Augustine's, Canterbury, who, after a careful inquiry lasting four days, found nothing amiss.⁸⁶ The replies of the abbot and convent on the subject of the reformed Benedictine statutes in 1253 give the same good impression.⁸⁷

Artistic and literary activity here was at its highest point in the abbacies of William de Trumpington and John de Hertford. Walter de Colchester died in 1248,⁸⁸ but seems to have had a worthy successor in his nephew Richard the Painter,⁸⁹ who in 1250 already had a long

list of works to his credit.⁹⁰ Master Simon, Richard's father,⁹¹ also painted at St. Albans, and there is mention of another painter here, Alan, a lay brother.⁹²

The house was strong on the literary side during this period. Roger of Wendover, the Prior of Belvoir recalled to the abbey by Abbot William,⁹³ found there occupation better suited to his gifts in the compilation of a chronicle.⁹⁴ When he died in 1236 his place as historiographer was taken by Matthew Paris, who continued the *Chronica Majora* and wrote also the *Historia Anglorum*. Matthew was the author too of the *Vitae Abbatum S. Albani* and several other works.⁹⁵

To a man endowed with the faculty to observe and record, life at St. Albans afforded great opportunities. Visitors of all kinds came to the abbey, mendicant friars, for whom special quarters were set apart,⁹⁶ strangers from the East,⁹⁷ princes and kings,⁹⁸ some to remain a night or two, others, like the dispossessed Bishop of Ardfert, to stay for years.⁹⁹

Abbot John's principal work in building, it may be noted, was a beautiful guest-hall,¹⁰⁰ and he devoted the revenues of Hartburn Church to the increase of hospitality,¹ in the exercise of

⁸¹ *Gesta Abbat.* i, 338-46. After a gift of £100 to Earl Richard.

⁸² Matt. Paris, *Chron. Maj.* v, 11-12; vi, 327-30, 379-80.

⁸³ During the vacancy of that see he tried to celebrate orders at St. Albans (*ibid.* v, 718-19).

⁸⁴ Matt. Paris, *Chron. Maj.* v, 42-5.

⁸⁵ The monks of St. Benet's asked for Matthew because he was a monk of the best regulated house in England and a great friend of their king's.

⁸⁶ *Ibid.* 258-9. It is remarked, however, that the abbot did not keep a promise made just before the visitation that he would restore the pittances of the sick converted by his predecessor to his own use, and would remit his allowance and pittances unless he dined in the refectory or oriel.

⁸⁷ *Ibid.* vi, 235-47. They observed the rules as to attendance at services, general confession, communicating and silence, the disposal of offices, care of the sick, that requiring the abbot and prior to remain in the cloister with the brothers and to be present at service, chapter and collation, those prohibiting monks to have property and to go out as they pleased, and the abbot to give the church's property to his kinsfolk, those also forbidding the diverting of alms and the giving of leave to monks to talk alone with women; they observed too the rules regarding dress, a common table, borrowing and rendering of accounts, with immaterial modifications, and that concerning novices with the addition that profession was allowed within the term of probation.

⁸⁸ Matt. Paris, *Chron. Maj.* vi, 278.

⁸⁹ *Gesta Abbat.* i, 233.

⁹⁰ Matt. Paris, *Chron. Maj.* vi, 202. In Abbot Roger de Norton's time he was warden of the altar of St. Amphibalus (Cott. MS. Jul. D iii, fol. 27).

⁹¹ He was Walter's disciple or pupil (*Gesta Abbat.* i, 233). It is improbable, however, that he was one of the convent (*Arch.* lviii, 280).

⁹² He died in 1245 (*Chron. Maj.* vi, 277).

⁹³ See above.

⁹⁴ He continued a work begun in the time of Abbot Simon or John de Cella (Hardy, *Descriptive Cat. of Hist. Materials* [Rolls Ser.], iii, Introd. p. xxxiv; Luard, *Chron. Maj.* i, Introd. p. lxxvi). The latter believed John de Cella to be the author of the earliest compilation (*op. cit.* ii, p. ix).

⁹⁵ Hardy, *op. cit.* iii, pp. xlvi-xlviii.

⁹⁶ Matt. Paris, *Chron. Maj.* iv, 600.

⁹⁷ The Archbishop of Greater Armenia in 1228 (*ibid.* iii, 161) and Armenians again in 1252 (*ibid.* v, 340-1). Other interesting visitors were the chaplain of the Emperor Baldwin (*ibid.* iii, 80-1) and the English monk from the valley of Jehosaphat, who came to sell relics (*Gesta Abbat.* i, 291).

⁹⁸ Henry III came several times, twice in 1244 (*Chron. Maj.* iv, 358, 402), in 1251 (*ibid.* v, 257), 1252 (*ibid.* 319), 1255, 1256, 1257 (*ibid.* 489, 574, 617) and 1259 (*Flor. Hist.* [Rolls Ser. 95], ii, 431), and made many offerings, especially of silk hangings (*Chron. Maj.* vi, 389), to the church. Visits are recorded of the Earl of Cornwall (*ibid.* iv, 43), Queen Eleanor (*ibid.* v, 653), and the King and Queen of Scotland (*Flor. Hist.* ii, 459).

⁹⁹ Matt. Paris, *Chron. Maj.* iv, 501-2. The prior and some monks of Coventry received hospitality here for over a year (*ibid.* iv, 171-2), and Richard Bishop of Bangor came in 1248, intending to stay for some time (*ibid.* v, 2).

¹⁰⁰ *Gesta Abbat.* i, 314.

¹ *Ibid.* 321.

RELIGIOUS HOUSES

which he seems to have shone. It was his easy munificence as much as his goodness that made St. Albans attractive in his time as a training school for young nobles.² He spent no doubt on his house³ what so many of his predecessors had lavished on their kinsfolk.⁴

At John de Hertford's death in April 1263 the king again sold the vacancy to the convent, but doubled the price.⁵ The papal confirmation of the election of Roger de Norton cost at least £800.⁶ The dominant note of Roger's administration seems to have been diplomatic prudence. He could bow to circumstances and yield a point, if by so doing he gained on the whole. Thus his agreement in September 1264 with the Countess of Arundel as to the advowson of Wymondham Priory⁷ and his arrangement with John Fitz John about Horwood Chase (co. Bucks.)⁸ were both in the nature of a compromise. His complaisance to Robert de Pynkeney in 1279 over the presentation to Datchet Church,⁹ and the purchase from the Earl of Hereford in 1285 of a dubious claim to the advowson of Hatfield Peverel Priory,¹⁰ were prompted by the like discretion.

Relations between the abbot and convent and Archbishop Kilwardby were very much strained on one occasion through the refusal of the St. Albans proctors on the archbishop's demand to show evidence of appropriations of churches.¹¹ The abbot, however, invited the archbishop to St. Albans at a convenient opportunity, received him with great ceremony, and explaining how the abbey stood, completely mollified him.¹² While in the North on a visitation of Tynemouth in 1278 he was as successful with the Bishop of Durham.¹³

In company with the other exempt clergy, Roger ignored Archbishop Peckham's summons to a council at Lambeth in October 1281. When sequestration followed he appealed, but

² *Gesta Abbat.* i, 397.

³ Besides being hospitable he was generous to the convent. He gave about 1,000 seams of corn to improve their ale (*ibid.* 323), and for their benefit separated their buttery from his and from that of the seculars at a cost of 463 marks (*ibid.* 395-6).

⁴ He is noted (*ibid.* 323) as quite an exception in this respect, and complaints had certainly been made of Paul, Richard de Albini, Geoffrey de Gorham, Ralph de Gorham, Simon, Warin and John de Cella (*ibid.* 64, 71-2, 95, 181, 194, 216, 252).

⁵ They paid 600 marks (*Cal. Pat.* 1258-66, p. 256).

⁶ The amount that the pope gave the St. Albans proctors leave to borrow (*Cal. Papal Letters*, i, 386). Probably the business cost more (*Gesta Abbat.* i, 399).

⁷ *Gesta Abbat.* i, 407-9.

⁸ *Ibid.* 423-5. This ended a long dispute.

⁹ *Ibid.* 440-4.

¹⁰ *Ibid.* 471.

¹¹ *Ibid.* 431-3.

¹² *Ibid.* 434.

¹³ *Ibid.* 436.

eventually, like the majority, compromised to save expenses.¹⁴ It is in Roger's time that the abbey first had difficulties with its subjects, the townsmen in 1274 challenging the abbot's right to mulcture by setting up mills of their own.¹⁵ The law was against them, and in 1275-6 they made submission to the abbot, who received their peace-offering graciously and made some concessions.¹⁶ While the quarrel was at its height the queen came to St. Albans, and the abbot tried to get her into the monastery by a little used way so as to avoid the people who were waiting to lay their grievances before her. The move, however, was discovered by the townspeople in time, and the abbot had to excuse himself as best he could to Eleanor, who much resented the attempted trickery.¹⁷

Less is now heard of royal and papal extortion. But the abbot and convent were treated with flagrant injustice by King Henry in 1265, when they performed their knight service, and were made to pay a heavy commutation fine as well.¹⁸

A painful sensation must have been caused by the discovery of the frauds perpetrated by the abbot's two chaplains.¹⁹ To all appearance irreproachable, they took advantage of the trust reposed in them to seal charters and contract loans without the convent's knowledge, and finally absconded with ornaments and treasure. Greater carefulness on the abbot's part might perhaps have prevented this and other losses: for instance, the unnecessary expense and trouble caused by mislaying the deeds of Stanmore Manor which had been recovered by John de Hertford.²⁰ The large corrody given in return for Pinchfield Manor²¹ may have been justifiable, but it would be difficult to defend the grants of corrodies to his kinsfolk in his last illness.²² Yet the convent might consider itself on the whole fortunate in Roger, for he was a man of good life, religious and literary, and left the house scarcely 100 marks in debt.²³ Under him the abbot's apartments and the infirmary were rebuilt²⁴ and three bells made, St. Amphibalus, St. Alban and St. Katharine.

¹⁴ *Reg. Epist. Johannis Peckham* (Rolls Ser.), 276-80; 306-7; *Rishanger, Chron. et Annales* (Rolls Ser.), 96.

¹⁵ *Gesta Abbat.* i, 410.

¹⁶ *Ibid.* 413-23.

¹⁷ *Ibid.* 411-12.

¹⁸ *Rishanger, Chron. et Annales*, 41.

¹⁹ *Gesta Abbat.* i, 447-8.

²⁰ *Ibid.* 466-7.

²¹ *Ibid.* 484.

²² He took care that these should be under the convent's seal, so that they could not be revoked (*ibid.*).

²³ *Ibid.* 484. Yet taxation was sometimes heavy. The abbey's contribution as tenth in aid of the Holy Land imposed by the Council of Lyons in 1274 amounted to 200 marks (*ibid.* 468).

²⁴ *Ibid.* 482.

A HISTORY OF HERTFORDSHIRE

His own gifts besides contributions to these works consisted of 17 choral copes, 5 chasubles and several books.²⁵ Before his death, which occurred 3 November 1290,²⁶ the prior John Maryns approached the king²⁷ about the vacancy, but to no purpose. The convent's worst fears of the escheator's rapacity were realized.²⁸

When the new abbot John de Berkhamstead returned from the papal court he found the abbey so impoverished that he was unable to discharge the obligations contracted in Rome at the terms fixed.²⁹ His benediction had been delayed through a grievance of the Friars Minors against his predecessor.³⁰ For the moment restitution of temporalities, too, seemed likely to be deferred owing to a defect in the seal of the bull of confirmation.³¹ However, the abbot was at last installed on 22 June 1291, and gave a splendid feast.³²

In November 1292, apparently at the suggestion of the Prior and convent of Tynemouth, the king laid claim to the advowson of that priory, of which he said he had been wrongly deprived.³³ The abbot wisely decided to submit to Edward's favour, and in May 1293 received a grant of the advowson in perpetuity.³⁴ Probably John was at that time unaware of the part played by the prior, for he made no move until two or three years later. Then he effected a sudden and secret entrance into Tynemouth with an armed force, seized the prior and several of the convent and sent them in fetters to St. Albans, on the ground that they had intended to revolt.³⁵ The abbot had also difficulty, though of a different kind, over Wymondham Priory. Sir Robert de Tateshall, out of revenge for the withdrawal of a livery,³⁶ twice prevented him holding a visitation here.³⁷ Possibly the abbot lacked tact. It seems at least that a little pliability would have saved him these

affronts and the unpleasantness with Archbishop Winchelsey.³⁸

The villeins again gave trouble and the abbot used excommunication,³⁹ and in 1297 invoked the law against those who tried to injure St. Albans.⁴⁰

On the financial side the abbot had many anxieties. He began his rule in pecuniary embarrassment, and taxation at this time was very heavy. The bull *clericis laicos* made matters, of course, no easier: the abbot still paid a subsidy to the king, and had to endure also cessation of all services at the abbey until he could buy papal absolution.⁴¹ In 1300 he was disturbed by the pope's demand for 1,000 marks⁴² deposited in the abbey by the papal collectors and borrowed in 1286 by the king.⁴³ The abbey had to find the money,⁴⁴ but over this transaction it did not make a bad bargain. The king on 20 July 1301 confirmed their charters,⁴⁵ and granted that the prior and convent should have the custody of the house at every vacancy for 1,000 marks⁴⁶; he, moreover, remitted all their debts to him.⁴⁷

The abbot's shortcomings appear to have been the result of financial straits. He sold much wood and burdened the house with pensions and liveries.⁴⁸ Though kind and affable, he was hated by many because he removed the priors of cells for very slight reasons after he had received large sums of money from them. He was religious, too, yet he made no provision for masses for his soul and deprived the convent of the manor of Childwick, given to them by Abbot Roger to keep his anniversary.⁴⁹ He died, worn out by cares, in October 1301.⁵⁰

³⁸ When Winchelsey in 1300 asked to stay at the abbey, John required him first to seal a letter of indemnity. The archbishop declined and lodged in the town, and naturally saw intentional slights to himself in every pretension of St. Albans to exemption (*ibid.* 47-8). Abbot John had made no difficulty about receiving Archbishop Boniface in 1253 (*Chron. Maj.* v, 414), nor Abbot Roger about Archbishop Peckham's stay in 1280 (*Gesta Abbat.* i, 444).

³⁹ *Gesta Abbat.* ii, 23-4.

⁴⁰ *Cal. Pat.* 1292-1301, p. 316.

⁴¹ *Gesta Abbat.* ii, 26-7.

⁴² *Ibid.* 28.

⁴³ *Cal. Pat.* 1281-92, p. 232.

⁴⁴ *Cal. Close*, 1296-1302, p. 430.

⁴⁵ *Gesta Abbat.* ii, 35; *Cal. Chart. R.* 1300-26, pp. 17-21.

⁴⁶ *Gesta Abbat.* ii, 31-4; *Cal. Pat.* 1292-1301, p. 604. If the house was vacant for more than a year a proportionate amount was to be paid in addition.

⁴⁷ *Abbrev. Rot. Orig.* (Rec. Com.), i, 114; *Gesta Abbat.* ii, 34.

⁴⁸ *Gesta Abbat.* ii, 51.

⁴⁹ *Ibid.*

⁵⁰ *Ibid.* 50.

²⁵ *Gesta Abbat.* i, 482-3.

²⁶ Roger was ill for three years or more before he died.

²⁷ When he was at the abbey (*ibid.* ii, 4).

²⁸ *Ibid.* 4-6. He turned out the tenants of the abbot's manors and even seized the convent's estates, but these he was forced by royal writ to relinquish.

²⁹ *Ibid.* 19. He had borrowed 1,300 marks.

³⁰ *Ibid.* 12-16. Roger as conservator of the privileges of Westminster Abbey and of the Cistercians had been obliged to oppose them.

³¹ *Gesta Abbat.* ii, 18.

³² *Ibid.*

³³ *Ibid.* 19-20; *Plac. de Quo Warr.* (Rec. Com.), 585.

³⁴ *Cal. Pat.* 1292-1301, p. 11; *Gesta Abbat.* ii, 20-1.

³⁵ *Gesta Abbat.* ii, 21-3.

³⁶ The livery was due to the patron, and Tateshall's right to the patronage was questionable.

³⁷ *Gesta Abbat.* ii, 63-6.

RELIGIOUS HOUSES

The electors' choice of the prior, John de Maryns,⁵¹ pleased everybody but Richard de Hatford, Prior of Redbourn, who baulked in his own ambition tried to get the Archbishop of Canterbury to interfere, but only drew reproof upon himself.⁵² Maryns received the papal confirmation on 25 May,⁵³ and celebrated the inauguration of his abbacy with a splendid feast at which two abbots and thirteen knights were present.⁵⁴ His first work was to settle outstanding quarrels and grievances. He appeased the archbishop,⁵⁵ and conciliated Tateshall by a grant of the livery he wanted.⁵⁶ The manor of Childwick was restored by him to the convent,⁵⁷ and on 18 October 1302 he removed another cause of discontent by fixing the amount of bread and ale which the abbot could require from the refectorer.⁵⁸

On the death of the Prior of Wymondham in 1303 the abbot successfully asserted the exemption of the cells from the escheator's authority.⁵⁹ He also guarded the abbey's liberties in Buckinghamshire against the sheriff.⁶⁰

Maryns apparently found it no easier than his predecessor to reduce the financial affairs of the house to order. The expenses at the papal court were very heavy, over £1,700,⁶¹ and if the fine of 1,000 marks was paid to the king in June 1303,⁶² it was only done by borrowing.⁶³ St. Albans was at any rate so much in debt in April 1305 that its custody was committed by the king to William de Bolum, who held it until December 1306.⁶⁴ Even then it was not free from difficulties. Only a few months later Walter Langton, Bishop of Lichfield, the king's treasurer, was endeavouring to get from the abbey an annual pension of £30 for three lives in return for his loan of £900.⁶⁵ One of the brothers pointed out to the abbot that to pay debts thus was not only uneconomical but dangerous, as it would lead to similar demands from the king and others. Maryns faced by a present peril would not listen, and in the

bishop's presence enjoined the convent to grant the annuity. But as the monks were most disinclined to acquiesce, the business was protracted,⁶⁶ and before further pressure could be used Edward I died and Langton's fall followed immediately. The relief, of course, was only comparative, for the money had still to be repaid.⁶⁷ Maryns's neglect to supply two carts on the new king's demand seems to have been a mistake. Edward was so much annoyed⁶⁸ that the abbot, to placate him, after sending a peace-offering of money,⁶⁹ made him a present of his wood at Langley.⁷⁰ Maryns was unable to fulfil his intention of putting the temporal affairs of the house on a satisfactory footing.⁷¹ Before he died he explained to the prior and senior monks that the house was about £2,000 in debt, and advised them to choose for his successor a good and simple man, and not one proud and pompous.⁷²

The ordinances he made for the abbey and cells⁷³ show that discipline and conduct were no longer what they had been. The rule of silence was to be kept,⁷⁴ and satisfaction was to be made for every infraction, not occasional amends after much breaking of the rule; there must be no idle talk and slander; there was to be no swearing by the wounds, blood or limbs of Christ; none but the cellarer or kitchener was to keep a dog for coursing; there must be no wandering about alone, nor loitering at doors talking to women, and except in company of a brother of mature age none was to hold converse with a woman; private property was strictly forbidden; the chamberlain was never to give money to the brothers instead of clothes, and when new clothing was allotted the old must be given up; food left over from meals was to be distributed in alms; the order of priesthood was not to be given too soon, and outside office was not to be bestowed on a monk who had not been three years in the cloister and behaved well during that time.

The changes Maryns introduced, if generally in the direction of diminished strictness, were marked by humanity and good sense. Certain

⁵¹ Maryns had had long experience of office. He had been cellarer from 1281 to 1287 (Stowe MS. 849, fol. 15 d.—18 d.), and had probably then been made prior.

⁵² *Gesta Abbat.* ii, 53-4.

⁵³ *Ibid.* 55.

⁵⁴ *Ibid.* 56.

⁵⁵ *Ibid.* 48.

⁵⁶ *Ibid.* 63-4.

⁵⁷ *Ibid.* 66-9.

⁵⁸ *Ibid.* 69.

⁵⁹ *Ibid.* 82-9.

⁶⁰ *Ibid.* 79-80.

⁶¹ *Ibid.* 56-8.

⁶² *Cal. Close*, 1302-7, pp. 42-3.

⁶³ According to the *Gesta Abbat.* (ii, 108), at the abbot's death the 1,000 marks were still owing.

⁶⁴ *Cal. Pat.* 1301-7, p. 335.

⁶⁵ *Gesta Abbat.* ii, 90-3.

⁶⁶ To consult the priors of cells, who refused to burden their houses.

⁶⁷ To the king, instead of Langton (*Gesta Abbat.* ii, 94; *Cal. Fine R.* 1307-19, p. 29).

⁶⁸ When he came to St. Albans he would not see Maryns (*Gesta Abbat.* ii, 95).

⁶⁹ He sent 100 marks through Gaveston, to whom he gave £40 (*ibid.*).

⁷⁰ For the houses the king was building for the Dominicans (*ibid.*).

⁷¹ *Ibid.* 107.

⁷² *Ibid.* 108.

⁷³ *Ibid.* 95-106.

⁷⁴ It is said he allowed the convent to talk for the sake of learning, and the rule of silence was in consequence very badly observed (*ibid.* 107).

A HISTORY OF HERTFORDSHIRE

services were shortened that greater devotion might ensue⁷⁵; charities of drink on festivals between Michaelmas and Easter⁷⁶ were abolished, but permitted instead on Sundays from Easter to Michaelmas; the period of rest for those who had been bled was extended, and privileges of recreation were restored that John de Berkhamstead had withdrawn on account of their abuse⁷⁷; in pittances to sick brothers suitability to the needs of the recipients was alone to be considered, and not price as hitherto.⁷⁸

In spite of Maryns's last injunctions the electors made a bad choice. Still the mistake is not surprising: as cellarer⁷⁹ Hugh de Eversden had had a training in administration, and as a favourite of the king he might be expected to benefit the house. He was a tall, handsome, pleasant man.⁸⁰ On his election he is reported to have said that the brothers might have chosen a wiser and more learned man than himself but no better fellow.⁸¹ Unfortunately in an Abbot of St. Albans qualities other than social gifts were needed.

Hugh's small knowledge of Latin made him shrink from a visit to the pope, so he sent proctors to obtain his confirmation. The result was but double expense. His deputies, after staying a long while and making many presents, returned with the message that Hugh must go himself. He went, and to make up for deficiencies in learning gave so lavishly that he drew praise even from the greedy papal court.⁸² Such generosity was hardly in keeping with the state of the house, which in October 1309 had to be protected from the consequence of its inability to pay its debts.⁸³

Hugh, who had a special devotion for the Virgin Mary, seems at once to have set about the completion of the chapel in her honour begun long before.⁸⁴ He also renewed the quire stalls, in this work receiving help from the king, for Edward, hearing while on a visit to the abbey in March 1314⁸⁵ that it had been

⁷⁵ *Gesta Abbat.* ii, 101-2.

⁷⁶ On account of the shortness of the days (*ibid.* 103). John de Cella had abolished misericordes of drink (*ibid.* i, 235), but apparently they had been reintroduced.

⁷⁷ *Ibid.* ii, 104-5.

⁷⁸ *Ibid.* 103-4.

⁷⁹ As cellarer he held the manorial courts of Codicote from 1304 to November 1308 (Stowe MS. 849, fol. 26-31).

⁸⁰ *Gesta Abbat.* ii, 113. His head, probably a portrait, is sculptured in the arcade he built on the south-east part of the nave.

⁸¹ *Ibid.* ⁸² *Ibid.* 113-14.

⁸³ *Cal. Pat.* 1307-13, p. 194.

⁸⁴ *Gesta Abbat.* ii, 114-15.

⁸⁵ Trokelowe and Blaneфорde, *Chron. et Annales* (Rolls Ser.), 83. He offered to St. Alban a gold cross set with gems and containing relics.

his father's intention to restore the quire, gave 100 marks and timber for that purpose.⁸⁶ This was but one of many favours to Hugh⁸⁷ and the monastery. The abbot was appointed in April 1309 to survey the Templars' manors south of the Tweed, then in the king's hands⁸⁸; in May 1311 he received licence to acquire in mortmain property to the value of £100⁸⁹; in 1312 the abbey's charters were confirmed⁹⁰; in 1313 one of its liberties was defined for its advantage⁹¹; in April 1314 its privileges were declared unannulled by disuse.⁹² From a writ to the Exchequer in February 1314 it appears that the king had given the abbot and convent £100 and lent them £300⁹³; and in November 1325 he granted them a respite for two years of all debts due to him.⁹⁴

Edward's friendship for Hugh is shown even more plainly in the affair of Binham Priory. The abbot, on the authority at first perhaps of a papal faculty,⁹⁵ had extorted large sums from the cells. If his demands were refused, he threatened to quarter himself on the house or its manors for a protracted period, and the prior yielded to avoid a worse evil.⁹⁶ At last the Prior and convent of Binham revolted,⁹⁷ and with the aid of their patron, Robert de Walkefare, in 1319 excluded the abbot from visitation.⁹⁸ William de Somertone, the prior, appealed in person to the pope, and the abbot was summoned to Avignon to answer him. Here the king intervened. Hugh, apparently ready to obey the pope, started, but at Dover was arrested by Edward's orders and made to desist from his journey, much to his satisfaction.⁹⁹ Through the king's help too he was enabled to take the rebellious monks prisoners to St. Albans¹⁰⁰ and get hold of Somertone and his papal bulls, which of course were not seen again.¹ It seems a curious anti-climax that the

⁸⁶ *Cal. Close*, 1313-18, p. 53; *Gesta Abbat.* ii, 123-4.

⁸⁷ It is said that there would have been no limit to the riches and honours Hugh could have obtained had it not been for his modesty (*Gesta Abbat.* ii, 119).

⁸⁸ *Cal. Pat.* 1307-13, p. 112.

⁸⁹ *Ibid.* p. 346.

⁹⁰ *Cal. Chart. R.* 1300-26, p. 204.

⁹¹ *Ibid.* p. 216.

⁹² *Ibid.* p. 245.

⁹³ *Cal. Close*, 1313-18, p. 38.

⁹⁴ *Cal. Pat.* 1324-7, p. 193.

⁹⁵ *Cal. Papal Letters*, ii, 75.

⁹⁶ *Gesta Abbat.* ii, 130.

⁹⁷ *V.C.H. Norfolk*, ii, 344.

⁹⁸ *Gesta Abbat.* ii, 130; *Cal. Close*, 1318-23, p. 140.

⁹⁹ *Gesta Abbat.* ii, 133, 135-8. He was forbidden to leave the realm by royal writ 26 March 1320 (*Cal. Close*, 1318-23, p. 226).

¹⁰⁰ *Cal. Close*, 1318-23, p. 271; *Gesta Abbat.* ii, 131.

¹ *Gesta Abbat.* ii, 140.

RELIGIOUS HOUSES

abbot should afterwards have restored Somerton to Binham; but the prior had powerful supporters² and Hugh was not courageous.³ The abbot's conduct towards the cells makes it improbable that the villeins were treated justly by him. Their attempt to throw off the abbey's yoke just after the deposition of Edward II was certainly characterized by bitter hostility. They laid regular siege to the abbey, and tried to reduce it by starving out the monks and by a sudden nocturnal attack.⁴ The negotiations at St. Paul's resulted in a victory for them, and the abbot had to cede to them freedom of his warren and the right to raise hand-mills at their will.⁵ It was a crushing blow to Hugh, who survived the humiliation only a few months. He left debts of 5,000 marks and a large burden of pensions and corrodies. Moreover, for immediate gain he had let property very disadvantageously, and had recklessly wasted wood.⁶ Altogether from extraordinary sources he raised over £18,000 during his abbacy.⁷ It is not denied that some of the expense was legitimate and even unavoidable. He was heavily handicapped at the start with the debts and heavy charges of the three preceding abbots.⁸ Wars diminished the value of the abbey's possessions,⁹ especially in the North¹⁰; in 1315 there was a bad famine¹¹; and the collapse of buildings in 1323¹² made extensive repairs¹³ inevitable. The arrangement by which the appropriation of Coniscliffe Church was at last rendered effectual¹⁴ was not made without cost, and the same is true as to the acquisition of Caldecote Manor¹⁵ and other property. Yet when all is said, the abbot's actual needs and

difficulties only make his profusion more inexcusable. What can be thought of a man who, while wringing money from the dependent priories, bestowed a pension for life on a baby merely to get a name for munificence?¹⁶ He seems to have been equally shallow and selfish. Religious in the sense that he was careful to ordain his anniversary,¹⁷ he brought his reputation and profession into contempt by his fondness for women's society.¹⁸

He was followed by the most interesting of all the Abbots of St. Albans. Richard de Wallingford, the son of a blacksmith of Wallingford, lost his parents when he was ten years old, and was cared for and educated by the prior of his native place, who sent him to Oxford.¹⁹ When twenty-two years of age he became a monk at St. Albans, but after three years there returned to Oxford, where he spent the next nine years²⁰ in the study of theology, philosophy, and particularly mathematics, for which he had a special bent.²¹

His hesitation at accepting office was believed to be feigned,²² but the thought of undertaking such responsibility might well make him pause. Everything spoke of difficulty. The financial problem was prominent at once, for all the obedientiaries and most of the priors of cells omitted to give the present usually made to a new abbot.²³ When Richard in the company of Nicholas de Flamstead, who became his great counsellor and friend, reached Avignon he found that his election was not in form.²⁴ To avoid delay and expense he therefore asked the pope to provide an abbot, and was himself appointed by papal provision.²⁵ From the first he struck the note of retrenchment: in the interval between election and the journey to the pope he had lived in the humblest style,²⁶ and at the feast of inauguration he dined in the frater with the convent, not with the great people in the abbot's chamber.²⁷ At one time too he certainly meant to live away from the abbey²⁸

² *Gesta Abbat.* ii, 141.

³ *Ibid.* 176.

⁴ *Ibid.* 158-9; 160-1.

⁵ *Ibid.* 163-76.

⁶ In March 1327 the king appointed commissioners to inquire by whose negligence the abbey's revenues had been dissipated (*Cal. Pat.* 1327-30, p. 84).

⁷ *Gesta Abbat.* ii, 178-81.

⁸ *Ibid.* 181.

⁹ *Ibid.*

¹⁰ *Ibid.* 117-18.

¹¹ Trokelowe and Blaneforde, *Chron.* 89, 92. When the king came to the abbey in August that year there could scarcely be found food for his household.

¹² The northern wall behind the dormitory and part of the south side of the church both fell. The accident to one of the brothers and his man in the hostrey shows that restoration was needed elsewhere (*Gesta Abbat.* ii, 127-9).

¹³ The abbot incurred great expense, and he and the convent made some sacrifice to repair the damage to the church (*ibid.* 125).

¹⁴ *Ibid.* 115-17; *Reg. Palat. Dunelm.* (Rolls Ser.), ii, 1042-4; 1051-2; iv, 126; *Cal. Pat.* 1313-17, p. 260.

¹⁵ *Add. Chart.* 19959; *Cal. Pat.* 1317-21, p. 563.

¹⁶ *Gesta Abbat.* ii, 177.

¹⁷ In February 1313 (*ibid.* 126-7). The Bishop of London in August 1312 had offered an indulgence of forty days to those who prayed for the abbot's good estate and for his soul after death (*Reg. Palat. Dunelm.* i, 192-3).

¹⁸ *Gesta Abbat.* ii, 177.

¹⁹ *Ibid.* 181-2.

²⁰ He appears therefore to have been thirty-four when he became abbot.

²¹ *Gesta Abbat.* ii, 182. He regretted afterwards that he had not spent longer in the cloister, and that he had devoted so much of his time to mathematics.

²² *Ibid.* 185. ²³ *Ibid.* 186-7. ²⁴ *Ibid.* 187-9.

²⁵ *Ibid.* 190; *Cal. Papal Letters*, ii, 269.

²⁶ *Gesta Abbat.* ii, 186.

²⁷ *Ibid.* 194.

²⁸ Royal licence for this purpose was given 6 Feb. 1329 (*Cal. Pat.* 1327-30, p. 362).

A HISTORY OF HERTFORDSHIRE

for economy. The revelations at the abbot's first visitation of the convent²⁹ made plain the need of reform. Many were accused of carnal sin, though some cleared themselves, but, says the chronicler, how God knows³⁰; others were found guilty of disobedience,³¹ some of holding property, and certain, of obtaining entrance into the convent by simony. Richard dealt gently with all the offenders,³² but required those who had paid to become monks to renounce the order publicly. If his mildness was construed as weakness by any they were soon undeceived. Five obedientiaries, after repeated admonitions, continued to neglect payment of their share of the clerical tenth. The abbot therefore proclaimed them in chapter, removed them from office, excommunicated them and sentenced them to corporal discipline twice a week. It is true he was persuaded immediately to remit the sentence on a promise of amendment.³³ The episode was a revelation of Richard's determination to be master, and was like a challenge to the disaffected. A conspiracy was set on foot to depose the abbot on the ground of his illness, for he was believed to be suffering from leprosy,³⁴ or to get the king to appoint one of their party as warden. Richard, outwardly unperturbed, said it was a matter of indifference to him whether he remained abbot or not, but he cared enough to excommunicate all who were trying to wrest his temporalities from him.³⁵ This may have quelled the sedition, for it was not successful. The abbot in due course visited the cells, published constitutions of reform,³⁶ the nature of which is probably to be gathered from those for Redbourn,³⁷ paid the poorest and most pressing creditors or came to terms with them,³⁸ repaired the abbey's property³⁹ and replenished stores.⁴⁰ He found time too for his own pursuits, compiling books on

²⁹ *Gesta Abbat.* ii, 196-7.

³⁰ The prevalence of sexual immorality shows that the women of the district may have had ground for their complaints of the monks made to Queen Isabella in 1327 (*ibid.* iii, 367), and explains the villeins' hatred of the abbey then.

³¹ To Abbot Hugh.

³² He felt he must go very carefully at first (*Gesta Abbat.* ii, 196).

³³ *Ibid.* 198.

³⁴ Immediately after his return from Avignon he had something wrong with one of his eyes (*ibid.* 193), and he was ill within a few months of his arrival at St. Albans (*ibid.* 197).

³⁵ *Ibid.* 199.

³⁶ And saw that they were observed (*ibid.* 201).

³⁷ *Ibid.* 202-5. See Redbourn Priory.

³⁸ *Gesta Abbat.* ii, 201. In one instance he compounded by payment of £40 for a debt of £127 10s. (*ibid.* 336-8).

³⁹ *Ibid.* 280-1.

⁴⁰ *Ibid.* 281. He made at least one agricultural experiment.

astronomy and geometry,⁴¹ and constructing a wonderful clock, to which he gave the punning name Albion.⁴² In this work he received no encouragement. The brothers thought it sheer folly, and the king, when on a visit to the monastery, told the abbot reproachfully that he ought rather to bestow his attention on the south side of the church still in ruins. Richard made an apt rejoinder: his successors could restore the church, for builders were always to be had, but if he left his clock unfinished, so it must remain.⁴³ Absorbed as he might appear in his occupations, his vigilance for the abbey's interest never failed. The attempt of the nuns of Sopwell at independence was quietly frustrated,⁴⁴ and the abbey's hold over St. Mary de Pré was strengthened.⁴⁵

To regain the rights of which the monastery had been deprived by the villeins was a more serious enterprise, and for this he had long to scheme and wait. With unobtrusive care he prevented the possibility of complications through ties of relationship between townsmen and convent and provided himself with friends among the neighbouring gentry.⁴⁶ When the moment seemed propitious he began the contest by a legitimate exertion of his ecclesiastical authority which was resisted,⁴⁷ as he had doubtless expected it would be. The villeins further put themselves in the wrong by indicting the abbot and archdeacon of the murder of the two men killed in the scuffle.⁴⁸ The abbot easily cleared himself, and then assuming the offensive brought a counter-charge of conspiracy against the coroner of the liberty, and accused the villeins of having extorted privileges from the abbot and convent by force. After winning a verdict as to his right to multure, he frightened or cajoled the townsmen into complete submission.⁴⁹ They entered into bonds of 3,000 marks to keep their agreements, gave up their common chest and mill-stones,⁵⁰ and in April 1332 surrendered their charter and seal into Chancery.⁵¹ Once triumphant he made friends with them unreservedly and delighted them all in spite of his disfigurement,⁵² for uncertainty

⁴¹ *Gesta Abbat.* ii, 201.

⁴² *Ibid.* 281. All by one.

⁴³ In this, said the chronicler (*ibid.* 282), he spoke truly, for in that art he left none like him. A star placed conspicuously over his head on his mutilated grave slab in the abbey church evidently commemorates his proficiency as an astronomer.

⁴⁴ See Sopwell Priory.

⁴⁵ See St. Mary de Pré.

⁴⁶ *Gesta Abbat.* ii, 202.

⁴⁷ *Ibid.* 217-18.

⁴⁸ One of whom was the abbot's marshal.

⁴⁹ *Gesta Abbat.* ii, 218-54.

⁵⁰ *Ibid.* 254-5.

⁵¹ *Cal. Close*, 1330-3, p. 558; *Gesta Abbat.* ii, 256-7.

⁵² *Gesta Abbat.* ii, 256.

RELIGIOUS HOUSES

about his disease had long since vanished. He was now in an advanced state of leprosy,⁵³ and his removal was again suggested, though not by the convent, whose admiration he had gained by his success over the villeins. As the result of outside intrigues the pope ordered an inquiry into the alleged maladministration of St. Albans through the abbot's ill-health,⁵⁴ and before the visit of the commissioners to the monastery took place in January 1333⁵⁵ provided to the abbey Richard de Ildesle, a monk of Abingdon.⁵⁶ On hearing of the papal provision, Richard dispatched Nicholas de Flamstead, now prior, to represent his case to the king in Parliament, and secured the support of the Council.⁵⁷ Moreover, to afford no ground for future interference, he proposed to the convent that he should have a coadjutor, and the prior was selected for that office.⁵⁸ But his strongest defence lay in the monks themselves, who let Ildesle know that if he ever tried to effect an entrance into the abbey they would kill him.⁵⁹ The abbot appears a rather lonely figure towards the end, for his affection for the prior sensibly diminished after Nicholas became coadjutor.⁶⁰ He thought him ungrateful for siding with the convent in a dispute about pittances.⁶¹ In the winter of 1334 he became much worse,⁶² but he lived until 23 May 1336.⁶³

Among his many benefits to the abbey must be reckoned the register he made of its deeds and the table of its privileges.⁶⁴ Through the influence of Richard de Bury, keeper of the king's privy seal, to whom he gave and sold books,⁶⁵ he obtained licence in January 1331 to

appropriate the church of Appleton in Ryedale (co. York).⁶⁶ He also secured a grant that on the signification of the Abbot of St. Albans as of a bishop the chancellor should issue writs for the arrest of excommunicated persons.⁶⁷ He helped to erect the new almonry and school-houses, began a new cloister, and built extensively at Tyttenhanger.⁶⁸

Richard had a worthy successor in Michael de Mentmore, a devout and learned man who had made profession at St. Albans in Abbot Hugh's time and had had charge of the studies there.⁶⁹ Conditions from the beginning were easier for him than for Richard. The pope confirmed his election without demur⁷⁰ on 18 November 1336,⁷¹ and a few days later granted an indulgence of 100 days to benefit the fabric.⁷² The king, too, gave very favourable terms for the payment of the fine.⁷³

Of course Michael had difficulties, but compared with Richard's they were unimportant. Through his predecessor's omission to cancel a bond of £200 he had to grant a pension to redeem the obligation.⁷⁴ Claims to an annuity and a debt settled long before were revived,⁷⁵ but here the abbot was sure of his ground. The abbey's ownership of Caldecote Manor⁷⁶ and of a messuage in London⁷⁷ had to be defended from the Prior of Bushmead and the Knights Hospitallers. The affair that gave most trouble was the endeavour of some of the abbey's tenants at Barnet to prove by forged charters that their land was not held in bondage.⁷⁸ Both sides bribed freely, and the abbot's victory was at one time anything but certain.⁷⁹

Michael's ordinances for the convent, for the most part explanatory of the statutes of Pope Benedict, published by him in 1338,⁸⁰ show throughout a sense of equity and order. One half of the convent was to dine in the oriel one day and the other half the next, that there might be no favouritism in granting relief from the monotony of meals in the frater.⁸¹ The kitchener

⁵³ In June 1330 he was said to be very infirm and weak (*Cal. Close*, 1330-3, p. 41), and by this time his voice was affected (*Gesta Abbat.* ii, 256).

⁵⁴ *Gesta Abbat.* ii, 284-5; *Cal. Papal Letters*, ii, 509.

⁵⁵ *Gesta Abbat.* ii, 286.

⁵⁶ *Ibid.* 287.

⁵⁷ *Ibid.* 287-8.

⁵⁸ *Ibid.* 289. The prior and convent then wrote to the pope stating that the abbey had derived great benefits from Richard's rule and explaining the measures he had taken for supplying his deficiencies.

⁵⁹ *Ibid.* 292. The author of the *Gesta Abbat.* adds they probably would have done so, for they were tall, strong men who had little scruple on this score.

⁶⁰ *Ibid.* 210.

⁶¹ Richard had come into collision with the convent before on this subject (*ibid.* 211-12). He may have been especially hurt at Nicholas's attitude because the monks who had wanted to depose him tried to injure him in respect of his pittances (*ibid.* 199).

⁶² *Ibid.* 293.

⁶³ *Ibid.*; *Cal. Pat.* 1334-8, p. 270.

⁶⁴ *Gesta Abbat.* ii, 207.

⁶⁵ He gave him four and sold him thirty-two (*ibid.* 200). Many of them were regained afterwards.

⁶⁶ *Cal. Pat.* 1330-4, p. 48.

⁶⁷ *Ibid.* 46. Possibly this was in preparation for his struggle with the townsmen.

⁶⁸ *Gesta Abbat.* ii, 282-3.

⁶⁹ *Ibid.* 299-300.

⁷⁰ *Ibid.* 301.

⁷¹ *Cal. Papal Letters*, ii, 531.

⁷² *Ibid.* 532.

⁷³ It was to be paid in annual instalments of 100 marks (*Cal. Close*, 1337-9, p. 13).

⁷⁴ *Gesta Abbat.* ii, 316-17.

⁷⁵ *Ibid.* 336-8, 355-7.

⁷⁶ *Ibid.* 330-3.

⁷⁷ *Ibid.* 342-3.

⁷⁸ *Ibid.* 317-26. The charters were smoked to make them appear old.

⁷⁹ At the critical juncture the abbot gained great advantage from the miraculous recovery of a drowned child through the merits of St. Alban (*ibid.* 326).

⁸⁰ *Ibid.* 305.

⁸¹ *Ibid.* 304.

A HISTORY OF HERTFORDSHIRE

was to provide two good and sufficient courses on fish and flesh days,⁸² for by this time it was permitted to eat meat. The amount of clothing to be allotted yearly was fixed, and not left as heretofore to the discretion of the chamberlain.⁸³ There was to be a fund to supply the monks with a few luxuries,⁸⁴ and this, with the money contributed in like manner by obedientiaries and priors of cells for the maintenance of scholars at the university, was to be administered by a committee of three chosen by the abbot, prior and convent respectively.⁸⁵ For the encouragement of learning at the monastery the abbot provided special quarters for students and changed the hour of one of the masses for their convenience.⁸⁶

As the result of actual losses⁸⁷ Michael forbade priors of cells and obedientiaries to act as proxies or executors of wills or undertake any public duty without the abbot's consent. Constitutions were made by him also for the hospital of St. Julian and for Sopwell.⁸⁸

Michael's goodness and charm attracted to the abbey an old knight, Sir Ralph Wedon, who boarded there for a time and gave the convent his manor of 'Heymundescote' (possibly in Amersham, co. Bucks.). For this, which it was judged more prudent to sell, they received 500 marks.⁸⁹ The stone quarry at Eglemount, another of Michael's acquisitions, was useful for his expensive building operations.⁹⁰ From motives of economy, since residence at Tyttenhanger involved expensive hospitality, he pulled down and sold his predecessor's hall there and built a house at Bradway which was more retired.⁹¹ He did much to the cloisters⁹² and finished the restoration of the south side of the church.⁹³ The abbot gave many books to the church,⁹⁴ and costly offerings were made by Dame Parnel de Banstead, who deserved remembrance, moreover, for her practical lesson to the convent.⁹⁵

⁸² *Gesta Abbat.* ii, 304.

⁸³ *Ibid.* 309.

⁸⁴ *Ibid.* 307-9. The sum given to each monk varied according to his rank in the convent.

⁸⁵ *Ibid.* 305.

⁸⁶ *Ibid.* 306.

⁸⁷ The Prior of Wymondham had seriously involved his house by acting as collector of wool (*ibid.* 313; *Cal. Pat.* 1345-8, p. 404).

⁸⁸ *Gesta Abbat.* ii, 315-16.

⁸⁹ *Ibid.* 364.

⁹⁰ *Ibid.* 363.

⁹¹ *Ibid.* 362-3.

⁹² *Ibid.* 362.

⁹³ *Ibid.* 361-2. The altars were consecrated by Hugh Bishop of Damascus.

⁹⁴ He spent over £100 in this way (*Cott. MS. Nero, D vii, fol. 21*).

⁹⁵ *Gesta Abbat.* ii, 365-6. To secure herself from robbers she brought into the abbey a box supposed to contain treasure, but really filled with lead and sand, as the monks found to their dismay when requested to give it back. She reassured them, but pointed out how unwise it was to receive any deposit without examining it before witnesses.

Abbot Michael fell a victim to the Black Death in 1349. He was taken ill on Thursday in Holy Week,⁹⁶ grew rapidly worse and died on Easter Day. He was gentle, modest and just, and was deeply mourned by all.

Michael's speedy burial did not prevent the spread of infection. The plague wrought havoc at the abbey, where forty-seven monks died,⁹⁷ including the prior and sub-prior.⁹⁸

The abbot's election was as usual by way of compromise, and the electors⁹⁹ after Henry de Stukle, Prior of Wymondham, had absolutely declined office, chose another of their number, Thomas de la Mare, Prior of Tynemouth.¹⁰⁰ There could have been none better fitted for the post. He had shown his ability in the offices of kitchener and cellarer at St. Albans and in his rule at Tynemouth¹; his goodness was as undoubted as his devotion to religion²; and, points by no means unimportant, he was handsome, well bred and well connected.³ At that time he was about forty years of age, in the prime of life and vigour. His journey to Avignon was not without dangers. One of the two monks accompanying him died of the pestilence at Canterbury, and owing to the disturbed state of France the party separated at Calais, where secular dress was assumed by all. At the papal court one of the examiners, Cardinal Gillelmo, hoping for presents, tried to delay the proceedings, but his efforts were frustrated by Cardinal Périgord, who had conceived a great liking for the abbot-elect.⁴ When confirmation

⁹⁶ *Gesta Abbat.* ii, 369. Nevertheless he performed all the services of that day without help.

⁹⁷ *Gesta Abbat.* ii, 370. What proportion of the total number died is not known. There is no clue to the size of the convent in early times except the ordinance of John de Cella limiting the number of monks to 100.

⁹⁸ *Ibid.* 381. The convent made Thomas de Risburgh, S.T.P., prior, and he created John Woderove sub-prior.

⁹⁹ Nine in number (*Cal. Papal Letters*, iii, 339).

¹⁰⁰ *Gesta Abbat.* ii, 382.

¹ A full account is given in the *Gesta Abbat.* (ii, 373-5) of his profession under Abbot Hugh, who placed him in the cell of Wymondham, of his life there for ten years, his transference to St. Albans under Abbot Michael and his promotion to be Prior of Tynemouth.

² He is said to have been devout from childhood (*ibid.* 372). As abbot he rose long before the convent for private devotions and was regular in his attendance at service, hearing three or four masses daily and celebrating one (*ibid.* iii, 400).

³ His father John de la Mare was a knight, his mother, the daughter of Sir John de Herpesfeld, and he was related to William Montagu Earl of Salisbury, William de la Zouche, lord of Harringworth, the Grandisons, John de Seintleger, John Argentein, &c. (*ibid.* ii, 371).

⁴ *Ibid.* 384.

RELIGIOUS HOUSES

and benediction⁵ had at last been received the abbot fell dangerously ill, recovering strangely enough after the drinking of some putrid water seemed to make the case desperate.⁶

On reaching home he went to do homage for his temporalities to the king, who was much attracted by him. It is said indeed that although he might be prejudiced against the abbot in his absence, his resentment always vanished as soon as he saw him.⁷

The king's assistance had to be involved at once against the papal nuncio who was unjustly demanding first-fruits from the new Prior of Tynemouth.⁸ The abbot had prevented, but only by heavy payment, a papal nominee being placed in the cell.⁹

In 1351, after sufficient time had elapsed for life at St. Albans to resume its normal aspect, Abbot Thomas published in a chapter-general at Michaelmas certain constitutions to be observed in the abbey and its cells.¹⁰ All the brethren were to attend and remain throughout divine service, which was to be given in its entirety; the psalms, sung hitherto without point or sense,¹¹ were now to be rendered with requisite pauses, and that the service might not take longer one or two omissions were to be made; a limit was also put to the reading of commemorations, that by preventing tedium, the divine office might be celebrated more devoutly than it had been; the festivals marked out for special observance were Christmas, Easter, Whitsuntide, the Assumption of the Blessed Virgin, and the Passion of St. Alban; the Dedication day of the abbey was to be kept in the cells. Priors of cells were to be as much as possible with their convents in order to instruct them by example and words; priests must not allow more than three days to elapse without celebrating mass; all the brothers, however small the convent, were to rise at night for matins, and that it might be easier for them to do so they were to sleep in the dormitory; the priest whose turn it was to perform high mass for the week must remain with the rest of the convent and not leave the cloister for any cause except illness; the then archdeacon, however, on account of the dignity of his office and his degree had permission to go to his study and to the consistory, the sub-prior was to visit the sick as usual, and the rule was not to apply to any guardian of the order who

had no superior in the house at the time of his course. That the hardness of the religious life might be apparent to novices, they were to be called to a chapter by their master at least every fortnight and punished for their faults; moreover, the Benedictine rule was to be read to them frequently that they might know what would be required of them. Brothers when their faults were published in chapter were not to deny their guilt untruthfully or defend their wrong-doing. The quiet of the cloisters was not to be disturbed by concourse of secular persons, and when the monks were there the entrance of women was forbidden. Monks both of the abbey and the cells instead of outdoor labour¹² were to occupy themselves with study, reading, writing, illuminating and binding books, or in such work for the benefit of the house as the abbot or priors thought best. The rule as to silence was to be strictly observed, a distinction being made in the punishment of habitual or occasional offenders. Brothers summoned to the table of the abbot or prior or to eat in the oriel were to abstain from detraction, contentions and idle conversation; there were to be no superfluous potations or empty talk after dinner, and not even in summer was the warden of the frater to allow this kind of indulgence as had been usual; confession to secular priests or religious of other orders was forbidden except in special circumstances; monks without leave of the head of the house where they lived must neither undertake to look after the property of secular persons nor deposit property with them. Food was to be provided for the brothers according to ancient custom as far as means allowed, so that they had at least two dishes daily; clothing to the annual value of 24s., but never money, was to be given to each brother; the rule as to old clothing and remains of food was reiterated. Alms must not be sold; the sub-prior was to visit those ill in the infirmary daily, and see that their needs were supplied; as far as their illnesses permitted, the sick were to be content with ordinary food, and they were not to stay in the infirmary longer than necessary; playing at dice or chess was forbidden to all; obedientiaries were exhorted to behave circumspectly, since by their conduct the outside world judged the religious generally; they must abstain from unlawful and fraudulent contracts and from misrepresentation in buying and selling, oppress none by force or unjust exactions, avoid women everywhere, never enter taverns, eat and drink only within the bounds of the abbey or priory, and if obliged to be away a night, first state the reason. To procure office by prayers or threats and the intervention of secular persons was forbidden

⁵ The election was confirmed 8 July 1349 and benediction received shortly afterwards (*Cal. Papal Letters*, iii, 336-9).

⁶ *Gesta Abbat.* ii, 385-7.

⁷ *Ibid.* 389-90.

⁸ *Ibid.* 393.

⁹ *Ibid.*; *Cal. Papal Petitions*, 172.

¹⁰ *Gesta Abbat.* ii, 418-46.

¹¹ Like smiths beating iron on an anvil, says the chronicler (*ibid.* 395).

¹² *Gesta Abbat.* ii, 433. 'Manual labour' appears to mean agricultural pursuits.

A HISTORY OF HERTFORDSHIRE

on penalty of disqualification for office during three years; on the other hand, persistent refusal of office was to be punished by excommunication and imprisonment.

The ordinances are an interesting revelation of the abbot's character as well as the state of the convent. The changes in the services aimed at making religious exercises real instead of mechanical; obstacles to the profession of suitable persons arising from matters unessential to religion¹³ were removed; at the same time an effort was made to prevent the entrance of those unfitted for monastic life.

The abbot may have had good reason to believe that the novitiate had not always been a test of vocation. That he found it necessary to forbid disputes and frivolous conversation at his own table is sufficient comment on discipline at St. Albans. He himself was exceedingly particular about manners¹⁴ as well as conduct, and in the end both his monks and servants became noted for the correctness of their behaviour. But the result could not have been attained without great steadfastness of purpose, and the immediate consequence is probably to be seen in the many monks who 'unable to bear the rigour of religion' apostatized in his time. Some of them returned,¹⁵ and to avoid the scandal caused by the frequency of public penance at the abbey for desertion it was provided that if the monks had run away from cells they should be punished at those places.¹⁶

There is an indication that after a few years of rule the abbot became rather disheartened in his wish to resign, communicated to King John of France when he visited the abbey during his captivity in England.¹⁷ On the king's return to France he was reminded of his promise to use his good offices with the pope in the matter, but was dissuaded by the Black Prince, who was convinced that the monastery would be ruined if the abbot carried out his intentions. The abbey chronicler regarded the projected resignation as an attempt to shirk a solemn trust, for which the abbot's subsequent trials were a judgement. It could hardly be said, however, that the abbot in actual deed failed in his duty. His sense of responsibility can be seen in his many contests on the abbey's behalf. These are

¹³ The excessive number of stories of saints to be learned by heart had proved a stumbling-block to many (*Gesta Abbat.* ii, 395).

¹⁴ However occupied with business, want of decorum never escaped his comment (*ibid.* iii, 410).

¹⁵ Eight did not. One of these, Stephen Gomage, may have been the brother Stephen whom the rectors of St. Mary and St. Nicholas and a chaplain of Hertford were accused of taking away from Redbourn in 1354 against the abbot's will (*Anct. Indict. K.B.* 9, file 38, m. 11).

¹⁶ *Gesta Abbat.* ii, 415.

¹⁷ *Ibid.* 408-9.

sometimes cited, though unfairly, as a proof of his litigiousness. It would have been impossible, for example, to ignore the affront offered to the house by Sir Philip Lymbury, who put John de la Moot, the cellarer, in the pillory at Luton.¹⁸ This matter was soon settled by Henry Duke of Lancaster; but the proceedings in John de Chilterne's case lasted for years.¹⁹

Chilterne, one of the St. Albans tenants, apparently disputed the abbey's right to a rent and refused to pay. The abbot at last, by way of distraint, seized fifty cattle which Chilterne defiantly told him he could starve for all he cared. Horrible to relate, this was done, the abbot's advisers telling him he would prejudice his cause if he fed them. Chilterne naturally enough was furious, and it was probably then that he accused the abbot of usurping the king's overlordship of certain land. Verdicts were given in the abbot's favour in 1364 and 1366, and Chilterne came to an agreement with the abbot and promised to abstain from further molestation. Resuming hostilities, he forfeited the bonds he had entered into, was outlawed, and fled to France, where he remained until the Black Prince and other influential friends of Abbot Thomas were dead. As soon as he returned the abbot had him imprisoned by writ of outlawry. Chilterne obtained his liberation once by assuring the king that he could give him information worth £1,000 against the abbey, but was immediately prosecuted again by the abbot. While in prison he renewed the matter of the overlordship, and, although the abbot gained the day in the end, the affair lasted until 1390.

In 1356 and 1368 the abbot brought a suit to recover from the parson of Harpole (co. Northants) arrears of a rent of 30s.²⁰ which by an agreement of 1348 was paid in lieu of tithes²¹; in 1365 he took proceedings against Richard Pecche for unlawful distress in a tenement belonging to the abbey in London,²² and in 1367 against the nuns of Markyate for payment of a rent which the prioress could not deny she owed.²³

Nor can it be said that his firmness was reserved for insignificant and comparatively powerless opponents. He prosecuted his case vigorously in the papal court in 1379 against the Archbishop of York, who had fined him for non-appearance at a synod to which he had not been summoned, and had unjustly sequestered the issues of the church of Appleton in Ryedale (co. York) appropriated to the monastery.²⁴

¹⁸ *Gesta Abbat.* iii, 3-5.

¹⁹ *Ibid.* 5-25.

²⁰ *Ibid.* 44-6, 54-5.

²¹ *Lansd. MS.* 375, fol. 108.

²² *Gesta Abbat.* iii, 77-80.

²³ *Ibid.* 87-92.

²⁴ *Ibid.* 278-9.

RELIGIOUS HOUSES

The king himself in his persistent attempts to exact a second corrody from the convent in 1358 met with a resolute resistance.²⁵ The abbot, however, saw the wisdom of leaving no room for future encroachments of this kind, and in 1364 bought out the royal right to a perpetual corrody,²⁶ as in 1350 he had given the king the advowson of Datchet Church in exchange for the convent's obligation on the creation of every new abbot to pay an annual pension of 100s. to a clerk nominated by the Crown.²⁷ It says something for the position occupied by Alice Perrers that she was the sole person before whom Abbot Thomas gave way. The relative of a former owner claimed some land in Oxhey granted to the abbey by John de Whitewell and his mother,²⁸ and to hold his own made it over to feoffees, one of whom was Alice Perrers.²⁹ From that time until she fell from power the abbot let matters rest. He then entered upon the land, and although he had subsequently a long contest on the subject with Sir William de Windsor and his nephew he made good his right.³⁰

More the question of exemption had to be fought more than once by Abbot Thomas. When the

²⁵ *Gesta Abbat.* iii, 100-12. The king, at the solicitation of one of his servants called John Gardiner, asked for him the office of warden of the warren of St. Albans on the ground that it had been held previously by William de la Marche, one of the royal household, and must therefore be in the gift of the Crown. The abbot proved that William had not held the post, and the allowance which he enjoyed had been given not because he was the king's servant, but for a special service rendered to the abbey. John Gardiner was a favourite of Edward III, and aided by the counsels of his father-in-law William Cheupayn, the king's jester, holder of the royal corrody at St. Albans, he caused some trouble until the Prince of Wales came to the abbot's aid (*ibid.* 394-5).

²⁶ The king received instead land in Abbots Langley (*Anct. D. [P.R.O.]*, A 5461; *Cal. Close*, 1364-8, p. 48). The corrody was to expire at the death of William Cheupayn.

²⁷ The king's nomination was made 20 Jan. 1350, the exchange on 14 May (*Cal. Close*, 1349-54, pp. 153, 222).

²⁸ John de Whitewell, the abbey's steward (*Gesta Abbat.* iii, 227), was a great benefactor to the house. He and his mother had licence in 1372 to grant to the abbot and convent five tofts, 2 carucates of land, 60s. rent, half a mill, meadow, pasture and wood in Watford, Cassio, Oxhey, Walround, and the reversion of a messuage, six tofts, 3 carucates of land in Kingsbury, Childwicksay and Sandridge. In conjunction with John Roland, Whitewell gave land and rents in Cassio, Watford, Park and Rickmansworth, and jointly with William de Bourton four messuages, a dovecot, 129½ acres of land and rent in St. Albans and Redbourn (*Pat.* 46 Edw. III, pt. ii, m. 15).

²⁹ *Gesta Abbat.* iii, 227-9.

³⁰ *Ibid.* 234-57; *V.C.H. Herts.* ii, 457-8.

Bishop of Lincoln asked to come to the obsequies of Blanche Duchess of Lancaster at the abbey in 1369 the abbot, suspicious of his intentions, made his consent conditional on a written acknowledgement of the monastery's privileges, which the bishop very reluctantly conceded.³¹

In 1380 De la Mare challenged the right of the Bishop of Norwich to make the Prior of Wymondham sub-collector of the clerical tenth in his diocese. The bishop persisted in his claim to the prior's obedience, but to no purpose³²; and in August of that year the king granted that neither the abbot nor the priors of his cells should be collectors or assessors of any subsidy.³³

The proposed visitation by the Archbishop of Canterbury of the Benedictine College at Oxford in 1389 concerned all the exempt monasteries, but Abbot Thomas was left to deal with the matter, principally, no doubt, because of the archbishop's affectionate regard for him.³⁴ The archbishop, in fact, received and heard the abbot's messenger with the utmost kindness and in the end graciously yielded.³⁵

Yet, notwithstanding the abbot's successful activity, it is more than hinted that fear or favour blinded him sometimes to the monastery's interests. For instance, he suffered a rent of 33s. 4d. due from the Earl of Salisbury, his kinsman, for a house at Paul's Wharf, London, to remain unpaid year after year; and in his time various rights granted by popes or kings were first withdrawn, especially the fines and amercements of the St. Albans tenants in the marshal's and other royal courts.³⁶ But it is unlikely that he submitted without protest to any injury to the abbey. He had once, at least, in the case of the clerk of the market of the king's hospice in 1364, claimed his privileges and won.³⁷

The insurrection of 1381³⁸ was the most formidable difficulty encountered by Abbot Thomas. Early in his rule the villeins may have shown signs of disaffection. The charge brought against the abbot in 1354 of permitting escapes from his gaol is said to have been due to a conspiracy on their part.³⁹

³¹ *Gesta Abbat.* iii, 274-5. The bishop, though angry at the time, laid aside his grudge when he met the abbot and became his fast friend (*ibid.* 277).

³² *Ibid.* 123-34.

³³ *Cal. Pat.* 1377-81, p. 532.

³⁴ Partly, perhaps, because Simon de Southeray, then prior, was a monk of St. Albans.

³⁵ Thomas Walsingham, *Hist. Anglicana* (Rolls Ser.), ii, 189-92.

³⁶ *Gesta Abbat.* iii, 417.

³⁷ *Ibid.* 55-6.

³⁸ See p. 198 above.

³⁹ *Gesta Abbat.* iii, 48-52. Attempts were also made by individuals to raise their legal status by making the abbot answer them in a court of law (*ibid.* 39-41).

A HISTORY OF HERTFORDSHIRE

It was possibly, indeed, a foreboding of danger in this quarter that induced the abbot in 1357 to crenellate the monastery.⁴⁰ There can, however, have been no apprehension or reason for it just before the rising. In fact, it seems certain that but for the outbreak elsewhere there would have been no movement here: there was no premeditated plan, no sudden explosion of anger, and very little violence and destruction. The villeins departed for London with the abbot's sanction,⁴¹ and it was not until they reached the city that there was a sign of the feeling that made the abbey's retainers hurry back to warn the prior and other unpopular members of the convent to escape. The deputation of townsmen in their negotiations with the abbot owned that he had been a just and kind lord and said they would have made no disturbance in his days if the opportunity had not been too good to let slip. The abbot's behaviour throughout was characteristic. He had first determined not to yield, and it was only the entreaties of the frightened monks that made him give way. Afterwards, if he was careful to recover the rights wrested from him,⁴² he did not forget it was his duty to protect his subjects, but interceded on behalf of the St. Albans villeins implicated in the London riots, interfered when Lee tried to frighten a jury into indicting the ringleaders, and seems to have done his utmost to avert the king's visit. The villeins, embittered by failure, accused him of hypocrisy and vindictiveness,⁴³ but apparently without foundation.⁴⁴ They did not cease to harass him where they could,⁴⁵ though the malicious burning of conventual property at Sandridge and elsewhere⁴⁶ a few years later is probably not to be attributed to them.

Just before the peasants' rising Abbot Thomas had undertaken measures of the greatest financial benefit to the abbey. The fine of 1,000 marks at every vacancy was in September 1380 exchanged by the king at the abbot's entreaty for a yearly rent of 50 marks.⁴⁷ To avoid the heavy expenses incurred by abbots-

elect at the papal court⁴⁸ Thomas negotiated with the pope in 1381⁴⁹ for a bull declaring election sufficient without confirmation and permitting benediction by any Catholic bishop. The indult was granted at last in October 1395, and first-fruits with all other payments on vacancies were commuted for 20 marks a year.⁵⁰ Another bull of the same date empowered the abbot and his successors to bless ecclesiastical vessels and ornaments of the monastery and its subject priories, churches and chapels.⁵¹

There is an occasional side-light on the internal affairs of the house. To remedy the lack of priests in the convent caused by the plague the pope in 1351 licensed the abbot to choose for ordination thirty monks of St. Albans and its cells between twenty and twenty-five years old,⁵² and in 1363 he granted similar dispensation for twenty monks aged twenty.⁵³

Visitations by deputies of the Abbot of Peterborough in 1378⁵⁴ and of the Prior of Ely in 1381⁵⁵ redounded to the praise of the convent. This satisfactory state of things was not the result of mere repression and severity. Abbot Thomas was a kind and just ruler.⁵⁶ Extremely ascetic himself,⁵⁷ he did not expect similar austerity in his monks. The increase in the income of the kitchener's office at his expense in 1363⁵⁸ had for its object the improvement of the convent's food supply,⁵⁹ and the reform he effected at Redbourn was to the same end.⁶⁰ But he insisted on the obedience due to him. Though he could not forbid, he undoubtedly resented the departure of the monks⁶¹ for the crusade in Flanders in 1383, and he promptly expelled those⁶² who in 1387 secured exemption from discipline by obtaining papal chaplaincies.⁶³

The work of members of the convent is perhaps the best testimony to his rule.

⁴⁸ Abbot Thomas spent 1,000 marks exclusive of the cost of the journey and his illness (*Gesta Abbat.* ii, 387).

⁴⁹ The abbot was much cheated by his agents, who, professing to be on the point of concluding the affair, received large sums for which they did nothing (*ibid.* 146-82, 397-8).

⁵⁰ *Cal. Papal Letters*, iv, 517.

⁵¹ *Ibid.* 501.

⁵² *Ibid.* iii, 383.

⁵³ *Cal. Papal Petitions*, 425.

⁵⁴ *Chron. Angliae*, 1328-88 (Rolls Ser.), 203.

⁵⁵ *Ibid.* 284.

⁵⁶ He visited and tended his monks in illness. He gave pittances too in compensation for the extra religious exercises he required from his convent and the nuns of Pré and Sopwell (*Gesta Abbat.* iii, 408).

⁵⁷ If obliged to relax his abstinence, he made up for it by severer fasts afterwards or by alms.

⁵⁸ See below, p. 413.

⁵⁹ *Gesta Abbat.* ii, 397.

⁶⁰ *Ibid.* 397-8.

⁶¹ *Ibid.* 416. He received them back with 'hoped for grace.'

⁶² Except one who was old.

⁶³ *Gesta Abbat.* ii, 418. These honorary chaplaincies were sold to raise money for Pope Urban.

⁴⁰ *Cal. Pat.* 1354-8, p. 574.

⁴¹ The abbot, it is true, did not want them to go in a body as they did, but they left St. Albans apparently on good terms with him.

⁴² Hearing that copies had been made of the charters before they were surrendered he petitioned the king and Parliament that record might be made of their annulment (*Parl. R.* iii, 129a).

⁴³ They said that far from endeavouring to stop the king the abbot had offered him £1,000 to come.

⁴⁴ The author of the *Gesta*, who was bitterly hostile to the villeins, and therefore could not have approved of the abbot's attitude to them, clearly did not doubt his sincerity.

⁴⁵ *Gesta Abbat.* iii, 360-1.

⁴⁶ *Ibid.* 361-2; *Cal. Pat.* 1385-9, p. 549.

⁴⁷ *Cal. Pat.* 1377-81, p. 545.

RELIGIOUS HOUSES

Full use seems to have been made of the scriptorium, rebuilt at his cost through the energy of Thomas de Walsingham, the precentor.⁶⁴ The beautiful 'Book of Benefactors of St. Albans,' now at Cambridge, witnesses to the great appreciation of artistic merit at this period.⁶⁵ Literary activity then was probably greater than since the days of Matthew Paris. 'The Chronicle of England, 1328-88,' 'The Chronicle by a Monk of St. Albans,'⁶⁶ 'The Annals of Richard II,'⁶⁷ and 'The English History' called Thomas Walsingham's were all largely due to his monks, whose work was at least equal in quality and surpassed in quantity that of their predecessors in the 14th century, Rishanger,⁶⁸ Trokelowe and Blanford. Of the brothers living at the abbey in 1380,⁶⁹ Thomas Walsingham was the author of the *Gesta Abbatum* from the abbacy of Hugh de Eversden.⁷⁰ Nicholas Radclif wrote against the Wycliffite doctrines,⁷¹ and Simon de Southerey was noted in his day for his verse and knowledge of astronomy.⁷² But scope was found for talent in other directions besides compiling or writing books.⁷³ John de Bokedene and William Stubard, a lay brother and stonemason, carried out various building operations,⁷⁴ Robert de Trunche was apparently a painter,⁷⁵

and a monk, William Walsham, helped to repair Abbot Richard's clock.⁷⁶ Several made handsome gifts of vestments and ornaments to the church⁷⁷ in emulation of their abbot, who was lavish in offerings.⁷⁸ Though these were the outcome of his own religious fervour, he was doubtless aware of the aid that splendour and beauty of ritual might render in that revival of devotion which he tried to promote⁷⁹ by preaching⁸⁰ and organizing solemn processions of intercession on special occasions.⁸¹ Thomas de la Mare resembled John de Hertford in his open-handedness. Unsparing of money on the affairs of the abbey, in upholding its rights, extending its privileges, in acquiring property⁸²

⁷⁶ *Gesta Abbat.* iii, 385.

⁷⁷ The great organs for the chapel of St. Mary were provided through the industry of John of Yarmouth; Thomas Goldsmith acquired for the house a chasuble, cope and alb of cloth of gold and another alb of green tartarin embroidered with gold goblets; Robert de Trunche gave a cope of cloth of gold elaborately worked, a sapphire ring to the chapel of St. Mary and a cloth of gold for the great altar; three others presented albs; Richard Savage had two silver-gilt suns made for St. Alban's shrine, and gave, besides various copes and albs, a set of vestments of green cloth of gold sprinkled with gold birds, the red orphreys decorated with images of St. John Baptist in gold; and William Westwik, the chamberlain, gave a beautiful jewel to contain a relic of St. Amphibalus (Cott. MS. Nero, D vii, fol. 81 d.-85).

⁷⁸ Among his gifts were a Lombard picture costing over £45, white and gold vestments priced at £186, a vestment of black velvet striped with gold, price £10; vestments to complete the set given by the Black Prince, £70; three mitres, £100; a pair of pontifical gloves set with pearls, £10; cloth for chairs and stools, over £148; the bell called 'Christus,' a silver-gilt tabernacle, censers, candelabra, &c. (*Gesta Abbat.* iii, 380-5).

⁷⁹ The fraternity in honour of St. Alban formed by the townsmen in 1377 to take part in processions in which the shrine figured shows that his efforts were to some purpose (*Chron. Angl.* 1328-88, p. 146).

⁸⁰ He made a careful study of preaching (*Gesta Abbat.* ii, 379), and apparently made a point of sermons to the people delivered by himself and his monks or others whom he appointed (ibid. iii, 408).

⁸¹ Ibid. iii, 408. These went to Sopwell and Pré, the chapels of St. Mary Magdalene and St. German, &c. There were also processions barefoot round the cloister or the church on Wednesdays and Fridays, and in them he took part in the coldest weather when very old and ill.

⁸² The church of Appleton in Ryedale (Yorks.) was appropriated in 1349 (*Cal. Papal Petitions*, 171) at a cost of £200; for the manor of Gorham he paid 800 marks; for that of 'Wrobbele Myrenden' (Meriden in Watford) £260; Snelleshall in Rickmansworth, co. Herts., £80, and for half the manor of Norton-le-Clay (co. York), acquired in 1354 (*Cal. Pat.* 1354-8, p. 89), £50 (*Gesta Abbat.* iii, 375-6).

⁶⁴ *Gesta Abbat.* iii, 393.

⁶⁵ For description see James, *Cat. of MSS. in Corpus Christi Coll. Camb.* i, 19. The illuminations of the other and artistically inferior 'Book of Benefactors,' Cott. MS. Nero, D vii, were due in part to a secular, Alan Straylere (fol. 108), but in the Corpus Christi MS. he is mentioned only as contributing money to the cost of the book (Trokelowe and Blanford, *Chron.* App. p. 464).

⁶⁶ The two are printed together in a volume of the Rolls Series.

⁶⁷ Included in the volume of the Rolls Series containing Trokelowe and Blanford's *Chron.*

⁶⁸ And the author of the chronicle that bears his name, see Rishanger, *Chron. et Annales* (Rolls Ser.), Introd. pp. xxxii-iv.

⁶⁹ Cott. MS. Nero, D vii, fol. 81 d.-83 d.

⁷⁰ See *Gesta Abbat.* ii, Introd. p. xix. The portion between Matthew Paris's work and Walsingham's was probably written by Rishanger (ibid. pp. ix-xix).

⁷¹ Cott. MS. Claud. E iv, fol. 331 d. seq. printed in Amundesham, *Annales*, ii, 305, App. E.

⁷² Ibid. He was evidently well known outside the monastery, for on 8 Nov. 1395 the king granted him an annual pension of £10 for life (*Cal. Pat.* 1391-6, p. 662).

⁷³ Three in 1380 copied or bound books. John de Rikemaresworthe wrote the great graduals for the precentor and sub-centor in the quire and two great books assigned to the abbot at matins, and made at his expense two books to be used at the mass of the Virgin (Cott. MS. Nero, D vii, fol. 82).

⁷⁴ Ibid. fol. 83.

⁷⁵ Ibid. fol. 84 d. He is said to have painted the figure of St. Thomas of Canterbury in the church.

A HISTORY OF HERTFORDSHIRE

and in building,⁸³ he also incurred great expense in presiding over the provincial chapter⁸⁴ 1351-63, in visitations of monasteries, probably those undertaken at the request of King Edward,⁸⁵ in presents to royal and noble patrons,⁸⁶ and especially in entertaining. He added new accommodation for noble guests,⁸⁷ and hospitality must have been continual and generous, for a staff of huntsmen and falconers was maintained, though neither the abbot nor his monks even looked on at sport.⁸⁸

The Black Prince was probably a frequent visitor⁸⁹; the King of France was received with all fitting ceremony⁹⁰; and among the many admitted to the fraternity of the convent, apparently while the abbot's guests,⁹¹ were the Princess of Wales with her daughter and two eldest sons in 1376,⁹² King Richard and Henry Earl of Derby in 1377,⁹³ the Duke of Gloucester in 1380,⁹⁴ and in 1386 the Duchesses of Gloucester and Lancaster.⁹⁵ Archbishop Sudbury visited the monastery in 1380,⁹⁶ and Courtenay, his successor, came by the abbot's invitation in 1382 and was splendidly entertained.⁹⁷

The outlay was not impolitic nor without return: the abbey gained a great reputation

⁸³ He rebuilt the Great Gate, part of the wall and the almonry, &c. (*V.C.H. Herts.* ii, 509). Altogether he spent considerably over £2,000 in this way (*Gesta Abbat.* iii, 387-9; Cott. MS. Nero, D vii, fol. 22 d.-24).

⁸⁴ *Gesta Abbat.* iii, 414-18. He became president in 1351 (*ibid.* ii, 402), when he published constitutions for the province, interesting for the light they throw on the general condition of the order (*ibid.* ii, 449-62). As president he gave pecuniary and moral support to Ralph Archbishop of Armagh in his contest in 1357 with the mendicant friars (*ibid.* ii, 405; Knighton, *Chron.* [Rolls Ser.], ii, 93-4). He presided, moreover, in 1363 (*Chron. Angl.* 1328-88, p. 52).

⁸⁵ Eynsham, Abingdon, Battle, Reading, Chester, where the abbot was forced to resign (*Cal. Pat.* 1361-4, p. 214), and St. Edmundsbury (*Gesta Abbat.* ii, 405-6).

⁸⁶ *Gesta Abbat.* iii, 390.

⁸⁷ *Ibid.* 387; Cott. MS. Nero, D vii, fol. 22 d. The difficulties of the office of sub-cellarer under Abbot Thomas (*Gesta Abbat.* iii, 390) were caused partly by the great number of guests who came to the monastery.

⁸⁸ *Gesta Abbat.* iii, 400.

⁸⁹ This seems the conclusion to be drawn from *ibid.* ii, 377.

⁹⁰ 'Curialiter et laudabiliter' (*ibid.* 408).

⁹¹ It seems to be mentioned when those who became capitular brothers or sisters were not present.

⁹² Besides gentlemen and ladies of her household (*Cott. MS. Nero, D vii, fol. 129*).

⁹³ *Ibid.* fol. 129 d.

⁹⁴ *Ibid.* fol. 131 d.

⁹⁵ *Ibid.* fol. 132 d.-133.

⁹⁶ *Chron. Angl.* 1328-88, p. 280.

⁹⁷ *Ibid.* p. 348.

and numerous friends, to its incalculable advantage. The list of benefactions in Abbot Thomas's day in itself is remarkable,⁹⁸ but the good feeling towards the monastery was manifested not only in gifts. The Black Prince,⁹⁹ Richard II,¹⁰⁰ John of Gaunt,¹ Archbishop Sudbury² and others³ rendered services of more or less importance to the abbey.

The abbot was attacked by plague during the second pestilence,⁴ and in his old age suffered constant pain from strangury.⁵ Yet not until he was physically prostrate did he yield to remonstrance and forgo his accustomed penance and abstinences. He was very infirm when the king visited him at the abbey in March 1394, and told him to ask what he wanted of him.⁶

⁹⁸ Richard II gave a gold collar in offering to the shrine (Trokelowe and Blanford, *Chron.* App. p. 433); Joan Princess of Wales gave a collar of gold, a silver-gilt cup to the abbot, and a cask of wine annually for many years (*ibid.* 435); Robert de Hatfeld, Bishop of Durham, bequeathed 100 marks to St. Albans (*Cott. MS. Nero, D vii, fol. 87*); Mary Countess of Pembroke, a silver-gilt image of St. Vincent containing a relic (*ibid.* fol. 103 d.); Adam Rous, the king's surgeon, gave vestments, a silver-gilt chalice and a tenement in Dowgate, London (*ibid.* fol. 104 d.); Robert de Walsham, at one time confessor of the Black Prince, gave altogether to the work of the cloister 400 marks (*ibid.* fol. 105 d.), and bequeathed to the church a silver-gilt basin, an ornament of gold and jewels to the abbot and convent for pious uses, and 100 marks to the monastery in relief of its poverty (*Harl. MS. 602, fol. 6 d.*); Richard de Threton, executor of Sir Robert Thorp, chancellor, gave 140 marks (*Cott. MS. Nero, D vii, fol. 106*); Sir Robert Knolles, £100 to the fabric of the convent kitchen (*ibid.* fol. 110); the Duke of Gloucester, 6 cloths of gold and a collar of gold and enamel set with sapphires (*ibid.*); Constance Duchess of Lancaster, £10 to the fabric of the kitchen, to the abbot a light blue cloth of gold for the orphreys of the copes given by the Duke of Gloucester, and a gold vestment trimmed with fur which was afterwards sold for the benefit of the church (Trokelowe and Blanford, *Chron.* 435, &c.).

⁹⁹ *Gesta Abbat.* ii, 377, 403-4; iii, 395.

¹⁰⁰ *Ibid.* iii, 151-8.

¹ The duke's interposition in 1391 saved St. Albans from lending 500 marks to the king (Walsingham, *Hist. Angl.* ii, 199).

² He confirmed the indulgences offered on the abbey's behalf and granted another (*Chron. Angl.* 1328-88, p. 280).

³ Archbishop Courtenay, for instance (see above and *Gesta Abbat.* iii, 281), and the Earl of Warwick, a chapter brother (*Cott. MS. Nero, D vii, fol. 129 d.*), who in 1383 renounced the claim to Redbourn Heath, which had caused the abbey so much annoyance and loss (*Gesta Abbat.* iii, 257-62).

⁴ That of 1362.

⁵ *Gesta Abbat.* iii, 403.

⁶ 'Annales Ric. II' in Trokelowe and Blanford, *Chron.* 167. The abbot's request for the confirmation of the abbey's charters remained, however, unfulfilled.

RELIGIOUS HOUSES

In October 1395 a papal indult was obtained permitting the claustral prior in the abbot's illness or absence to admit novices and absolve and dispense the monks for irregularity.⁷ Tended devotedly by his monks, the abbot lingered on, helpless and often in agony, but careful to the end of the welfare of his house.⁸ He died at length on 16 September 1396, aged eighty-seven, universally respected and admired.⁹

The convent's choice of the prior, John de la Moote,¹⁰ to be abbot seems natural in the circumstances. During the last two years he had had entire control over the house, and as he had great experience in administration,¹¹ he would appear best fitted to deal with a financial situation that called for able management. It was said, however, by some that the new abbot had been anything but loyal to his predecessor, that he had used promises and threats freely to secure his own election, and that he owed his success largely to the archbishop and the king.¹² The last charge is curious in the light of after events. Thomas de la Mare not having attended Parliament for some years before his death, his place, the first amongst the abbots, had been taken by others.¹³ On John de la Moote's appearance in Parliament the Abbot of Westminster attempted to take precedence of him. Moote, in a dilemma because of the king's friendship with his rival, decided to appeal to Richard himself, but the king, after telling him that he should have his rights, requested that the Abbot of Westminster might sit above him every other day until the matter was discussed further, and Moote, from fear, gave way. Richard's favour could be relied on so little that to preserve it Moote is said to have given him altogether £126.¹⁴ The abbot conceivably owed him no

good will, but it is difficult to accept entirely the story that the Duke of Gloucester's conspiracy against the king was set on foot at St. Albans and that Moote was present at the meeting at Arundel.¹⁵ He could hardly have played so prominent a part in the affair and escaped all consequences. Still, there could have been no doubt to which side Moote inclined, for on the king's fall he was appointed to guard the Bishop of Carlisle, Richard's partisan.¹⁶ If Moote engaged in political intrigue the departure from Abbot de la Mare's neutral attitude¹⁷ was scarcely justified by results. The immediate consequence of the accession of Henry IV was to increase the power of his half-brother, the Bishop of Lincoln, and so put the abbey at a disadvantage. When the bishop was to perform the obsequies of John of Gaunt at St. Albans in 1399, Moote obtained a royal writ to Beaufort forbidding anything derogatory to the abbey's privileges, and was able to exact letters of indemnity from the bishop and refuse to allow him and his mother to lodge in the monastery.¹⁸ But after Richard's fall the abbot permitted Beaufort to stay at the abbey and exercise episcopal rights within the exempt area, and only after propitiatory gifts secured from him an acknowledgement of the immunities of St. Albans.¹⁹ It is true that Henry IV was the first to give to the abbot the array of the clergy of the exempt jurisdiction,²⁰ and that shortly afterwards he came to the abbey, and was present at the services on Ascension Day 1400 in royal state,²¹ but when the relations of the king and Abbot Thomas are considered these do not seem extraordinary marks of favour.

Moote is said to have been responsible for some of Abbot Thomas's wisest measures, and perhaps truly. He showed his sense in his conciliation of the villeins at the beginning of his rule²² and in the useful papal bulls he obtained.

⁷ *Cal. Papal Letters*, iv, 400.

⁸ He delayed receiving extreme unction to prevent usurpation of the goods of the monastery (*Gesta Abbat.* iii, 420).

⁹ *Ibid.* 422-3. The author of the 'Annales Ric. II' speaks of him as the father and pattern of all religious, and says he was deservedly called 'Monachorum Patriarcha.'

¹⁰ *Gesta Abbat.* iii, 432-3.
¹¹ He was cellarer almost twenty years (Cott. MS. Nero, D vii, fol. 49 d.), and had been prior certainly sixteen (*ibid.* fol. 81 d.).

¹² *Gesta Abbat.* iii, 463-5.

¹³ Harl. MS. 3775 printed in Amundesham, *Annales* (Rolls Ser.), i, 414-17, App. B. The general order of precedence was perhaps not very definite (Hurry, *Reading Abbey*, 66, n. 2); but as regards Parliament it is worth noticing that among the triers of petitions in 1363 and 1366 (*Parl. R.* ii, 275, 289) the Abbot of St. Albans comes before the Abbot of Westminster, while in the roll of the Parliament held Feb. 1512 (Add. MS. 22306) Westminster is first and St. Albans second, the same order being observed in the roll of 1534 (*L. and P. Hen. VIII*, vii, 391).

¹⁴ *Gesta Abbat.* iii, 454.

¹⁵ *L'Ystoire de la Traison et Mort du Roy Richart Dengleterre* (Engl. Hist. Soc.), 121-6.

¹⁶ *Ibid.* 221 n.

¹⁷ 'The chronicle of a monk of St. Albans' known as 'the Scandalous Chronicle' proves that strong party feeling existed at the abbey, but it was evidently not apparent to the outside world. John of Gaunt, who is violently abused by the chronicler, was a good friend to St. Albans. The benefactors and chapter brothers of St. Albans were of all parties. Even Sir Lewis Clifford and Richard Stury, reputed Lollards, were admitted to the fraternity (Cott. MS. Nero, D vii, fol. 129, 131).

¹⁸ *Gesta Abbat.* iii, 438-40, 472.

¹⁹ *Ibid.* 440, 474-5. Moote gave the bishop £5, and exchanged for a sapphire ring one given by the Duke of Gloucester to Abbot Thomas containing a piece of the holy cross.

²⁰ *Ibid.* 437; Close, 1 Hen. IV, pt. ii, m. 19, printed in Dugdale, *Mon.* ii, 241.

²¹ Trokelowe and Blanford, *Chron.* 332.

²² *Gesta Abbat.* iii, 435.

A HISTORY OF HERTFORDSHIRE

Yet as abbot he was not satisfactory. In striking contrast to Thomas de la Mare, whose mistakes even arose from his generous nature,²² he readily gave ear to whisperers and informers and bore grudge silently against those he suspected.²³ But the principal cause of his failure lay in his one-sidedness, that had before manifested itself in an attempt to aggrandize each office held by him at the expense of the others.²⁴ His love of building, beneficial to the house as long as it was kept within limits, with the removal of control became a mania to which everything was sacrificed. While cellarer and prior he had done much good work²⁵ in keeping the abbey's property in order,²⁶ and after he became abbot he continued his improvements to the monastery and began to rebuild the students' rooms at Oxford. In the construction, however, of a princely residence for himself at Tyttenhanger, a scheme of doubtful value to the abbey,²⁷ he passed all bounds in extravagance and forgetfulness of duty. Estates were neglected so that rents decreased; hospitality and alms were cut down, numbers of hirelings were fed by the abbot, while obedientiaries and tenants were burdened with carriage to the detriment of their business; the cells were unvisited and, owing to his mistaken or careless choice of priors, were badly managed; and now, in order to urge on the operations at Tyttenhanger, the abbot was continually absent from the monastery, so that 'religion perished.'²⁸ At one time Moote had ingratiated himself with the convent, distributing among them the pigeons of his dovecot, doubling their supply of spices²⁹ and relaxing the rule as to recreation in Lent and Advent³⁰; latterly he had been mean and ungracious, and the monks were beginning to murmur loudly, when he was seized with pleurisy at Tyttenhanger, and died after a short illness at St. Albans on 11 November 1401, leaving many debts and stores and furniture much reduced.³¹

The election was notable for the outside influence exerted on behalf of the kitchener, Robert Botheby.³² Fortunately the king's per-

suasions and the interference of his treasurer were alike unavailing; the convent elected the cellarer, William Heyworth, by a large majority.³³ The new abbot, still only a probationer in religion, was very young,³⁴ but he was obviously skilful in dealing with men and affairs. He reconciled the king at once to the convent's choice, got through the necessary formalities with unusual speed and economy, and secured more credit.³⁵

The promotion of Botheby to be Prior of Wallingford,³⁶ while calculated to please the king, was also prudent in view of Heyworth's absence for two years from St. Albans to keep down expenses.³⁷ When finances had been reduced to order, the buildings at Oxford and Tyttenhanger were finished³⁸ and the cloisters completed.³⁹

The abbot saw that the newly-acquired papal indulgences did not fall into desuetude,⁴⁰ and carefully guarded the other privileges of his house. In 1405 he obtained from Henry confirmation of their charters, with the addition of a clause restoring to the Abbots of St. Albans fines of their men and tenants amerced in the courts of the king's steward and marshal, and clerk of the market of his hospice.⁴¹ He asserted in 1408 his right to the chattels of a felon taken within his liberty,⁴² and checked the attempts of the clergy of his exempt jurisdiction to deprive the abbey of Peter's Pence and other dues.⁴³ Payment of pensions owed by the parsons of Girton⁴⁴ and Lubenham⁴⁵ was enforced, and compensation received for the abbey's claim to the rent at Paul's Wharf.⁴⁶ Possibly Heyworth after a time found his task irksome: he showed certainly a strange apathy in allowing the Abbot of Westminster in 1417 to erect gallows on debatable territory, still called No Man's Land, between the abbey of Westminster's manor of Wheathampstead and the

³³ Through Botheby's party the election was by scrutiny, which offered greater opportunity than compromise of influencing the electors (*Gesta Abbat.* iii, 477).

³⁴ *Ibid.* 493.

³⁵ *Ibid.* 491-3. He obtained credit probably by dissimulating his need of money, for he gave the entertainments customary at an installation.

³⁶ *Ibid.* 493.

³⁷ *Ibid.* 494.

³⁸ *Ibid.* 495.

³⁹ Extract from Cott. MS. Nero, D vii, printed in the *Reg. of St. Albans* (Rolls Ser.), i, 451, App. D. He repaired, moreover, his hospice in London.

⁴⁰ *Gesta Abbat.* iii, 495.

⁴¹ *Ibid.* 497-9. These fines were withdrawn in the time of Thomas de la Mare.

⁴² *Gesta Abbat.* 509-12.

⁴³ *Ibid.* 505-9.

⁴⁴ Lansd. MS. 375, fol. 160-2 d.; *Gesta Abbat.* iii, 518-22.

⁴⁵ *Gesta Abbat.* iii, 523-5.

⁴⁶ *Ibid.* 513-17.

^{22a} He was too impulsive and trusting, and thus put people into offices for which they were unfit (*Gesta Abbat.* iii, 416).

²³ *Ibid.* 4:8.

²⁴ *Ibid.* 460.

²⁵ *Ibid.* 441-7; Cott. MS. Nero, D vii, fol. 24.

²⁶ He rebuilt many manor-houses, granges, &c.

²⁷ *Gesta Abbat.* iii, 448. See also Abbot Michael.

²⁸ *Gesta Abbat.* iii, 448-50.

²⁹ Possibly while he was prior (*ibid.* 444, 447).

³⁰ *Ibid.* 470-2. These ordinances, which deal also with certain services, were made at the urgent request of the convent.

³¹ *Ibid.* 450-3.

³² *Ibid.* 476-8.

RELIGIOUS HOUSES

St. Albans' manor of Sandridge. On 20 November 1419 he received the bishopric of Lichfield by papal provision,⁴⁷ and in 1420 resigned the abbacy.

John Bostock, or Wheathampstead, Heyworth's successor,⁴⁸ was a remarkable personality. Whatever may be thought of his learning, of his capabilities there can be no question. The friendship of Humphrey Duke of Gloucester for him, whether literary or political, is in itself evidence of his ability. Pedant as he seems in his letters,⁴⁹ he was undoubtedly a clever man of the world, who succeeded to an extraordinary degree in making St. Albans attractive to the great and influential. Duke Humphrey visited the monastery frequently: he came on Christmas Eve 1423 with his wife Jacqueline of Hainault and 300 retainers,⁵⁰ remaining until after the Epiphany⁵¹; in 1426 he spent three days here on his way to Leicester⁵²; in 1427 he offered at the shrine on recovering from an illness,⁵³ and that year kept Christmas splendidly at the abbey⁵⁴; in 1428 he made a short stay here⁵⁵; and in 1431 his second duchess, Eleanor Cobham, was received into the fraternity with some of her relatives and attendants.⁵⁶ The Duke and Duchess of Bedford with a train of 300 persons were entertained here in 1426 on the Festival of St. Alban⁵⁷; Queen Joan came in 1427 for worship,⁵⁸ and Queen Katharine and the little king in 1428 stayed for nine days at Easter⁵⁹; Henry Beaufort, Bishop of Winchester, visited the abbey in 1424, 1426, as cardinal in 1428 and twice in 1429⁶⁰; and in September 1430 the Duchess of Clarence was at St. Albans.⁶¹ Visits from the Earl of March,⁶² the Countess of Westmorland,⁶³ the Bishop of Lichfield,⁶⁴ Sir

William Babington, the chief justice,⁶⁵ are also mentioned. The Earl of Warwick was laid up here in 1428 and made liberal acknowledgement of the attention he received; he was admitted to the fraternity⁶⁶ like many others,⁶⁷ for the conferring of this honour was as much used as hospitality to increase the abbey's well-wishers.⁶⁸ It is a tribute to Wheathampstead's literary reputation that he was one of those chosen to represent England at the Council of Pavia-Siena in 1423⁶⁹ and that of Basle in 1431⁷⁰; and that he was asked in 1427 to compose the letter from the English clergy to the pope.⁷¹ While in Italy the abbot seized the opportunity to go to Rome,⁷² where he procured certain bulls,⁷³ and so established himself in the pope's favour that the Bishop of Lincoln decided to cease his attack in the Council on the abbey's exemption.⁷⁴ The question was afterwards raised in other quarters. The Archbishop of Canterbury took umbrage in 1424 at the non-appearance of the priors of the cells of St. Albans at his visitations, and the letting of tithes of appropriated churches to laymen without his leave.⁷⁵ As part of the campaign against the abbey Wheathampstead was made collector of the tenth in Hertfordshire and Buckinghamshire, but while obtaining the revocation of the appointment from the chancellor, he very sensibly went to see the archbishop⁷⁶ and managed to disarm his hostility.

A similar difficulty with the Bishop of Norwich was settled less easily. The bishop in

⁶⁵ While he was here in 1437 the abbot asked his advice about the questions between himself and the Abbot of Westminster (Amundesham, *Annales*, ii, 127).

⁶⁶ Amundesham, *Annales*, i, 22, 67.

⁶⁷ *Ibid.* 65-9; Cott. MS. Nero, D vii, fol. 136 d., 147 d., 150 d., 155.

⁶⁸ Many handsome gifts must have been received from chapter-brothers and sisters. Duke Humphrey in 1436 gave elaborate altar frontals and vestments, 25 cloths of gold and a great silver-gilt tabernacle (Amundesham, *Annales*, ii, 187-90). Margaret Duchess of Clarence presented 2 silver-gilt censers, frontals and splendid vestments (Cott. MS. Nero, D vii, fol. 152 d.).

⁶⁹ Amundesham, *Annales*, i, 99.

⁷⁰ *Ibid.* 275. The royal licence to him to take £400 in bullion with him was not granted until 6 May 1433 (*Cal. Pat.* 1429-36, p. 267).

⁷¹ Amundesham, *Annales*, i, 17.

⁷² He fell seriously ill here, and the pope sent him plenary indulgence (Amundesham, *Annales*, i, 148-50).

⁷³ Among them one for the use of a portable altar at the abbey's houses of London and Oxford, where the chapels were not yet consecrated (*ibid.* 161).

⁷⁴ *Ibid.* 73-81.

⁷⁵ *Ibid.* 195-6.

⁷⁶ To show him Archbishop Reynolds's letter of 1318 declaring the Abbot of St. Albans not subject to the archbishop (*ibid.* 200).

⁴⁷ *Cal. Papal Letters*, vii, 134.

⁴⁸ He was then prior.

⁴⁹ Many of these are printed in Appendix E of the *Reg. of St. Albans* (Rolls Ser.), ii, 365-475.

⁵⁰ *Chron. Rerum Gestarum in Mon. S. Albani*, printed in Amundesham, *Annales Mon. S. Albani* (Rolls Ser.), i, 4-5.

⁵¹ Cott. MS. Nero, D vii, fol. 147. On this occasion he became a chapter-brother.

⁵² Amundesham, *Annales*, i, 8.

⁵³ *Ibid.* 12-13.

⁵⁴ *Ibid.* 19.

⁵⁵ *Ibid.* 25.

⁵⁶ Cott. MS. Nero, D vii, fol. 154. It is related that she was once cured of a toothache by the intercession of St. Alban, and the duke in gratitude offered a golden tooth at the shrine.

⁵⁷ Amundesham, *Annales*, i, 10.

⁵⁸ *Ibid.* 16.

⁵⁹ *Ibid.* 21.

⁶⁰ *Ibid.* 5, 11, 28, 34.

⁶¹ *Ibid.* 54.

⁶² *Ibid.* 5.

⁶³ She came on a pilgrimage in 1428 with her son and his wife (*ibid.* 24).

⁶⁴ *Ibid.* 50-1, 55, 57.

A HISTORY OF HERTFORDSHIRE

revenge for the discourtesy shown him by the convent of Binham during a visitation made the prior collector of the next tenth.⁷⁷ The abbot in vain tried to pacify the bishop by letter and personal interview, and by the intercession of the Dukes of Gloucester and Bedford.⁷⁸ He then contested the matter in the Court of Exchequer and Convocation,⁷⁹ and after a long struggle seems to have been successful.⁸⁰

These cases are characteristic of Wheathampstead, who like De la Mare has been called litigious⁸¹ and with as good or as bad foundation. He was undoubtedly tenacious of the rights of his house, but seems to have been diplomatic rather than aggressive. In the means used to attain his ends, however, he was not always quite scrupulous. It has been noticed,⁸² for instance, that while Offa's charter contained nothing about exemption from episcopal jurisdiction, there was much that bore directly on the point in the copy produced by the abbot before the Exchequer judges on the above occasion. The way judgement was ensured against the rector of Harpole can hardly be approved. After a consultation with Bekyngton, Dean of Arches, over a pension withdrawn from St. Albans for thirty years,⁸³ the abbot secured the Bishop of Lincoln's consent to the trial of the case in the Arches Court, where the decision in favour of the abbey in 1430⁸⁴ was a foregone conclusion.

Wheathampstead showed his discretion in coming to terms the same year with Thomas Knollys over right of chase in Tyttenhanger Heath, that had been in dispute in Heyworth's time⁸⁵; he was also prudent and fortunate enough to persuade William Flete to submit the questions between them to the arbitration of Sir William Babington, and thus settle amicably an affair that might have proved as harassing

⁷⁷ Amundesham, *Annales*, i, 300-1.

⁷⁸ *Ibid.* 305-10.

⁷⁹ *Ibid.* 311-65. The point seems to have been whether Wheathampstead had protested for the abbey and cells when the convocation granting the tenth had declared that no collector should be excused by obtaining royal immunity or privilege.

⁸⁰ The result is not given in the *Annales*, but in the account of the abbot in Cott. MS. Nero, D vii, printed in *Reg. of St. Albans*, i, App. D.

⁸¹ Riley's Introduction to Amundesham, *Annales*, ii, p. xiii. Wheathampstead was apparently considered litigious for defending the abbey's rights and Heyworth indolent and unsatisfactory (*ibid.* i, p. xxvii) for not doing so.

⁸² *Ibid.* ii, p. xlvi.

⁸³ Apparently after a verdict against the abbey in the Court of King's Bench on a technical issue (Amundesham, *Annales*, i, 233).

⁸⁴ *Ibid.* 232-54; Arundel MS. 34, fol. 25-31 d. For the examination of witnesses for the abbey see Lansd. MS. 375, fol. 6-17 d.

⁸⁵ Amundesham, *Annales*, i, 254-61.

as Chilterne's.⁸⁶ A dispute with the rector of Girton about a pension was referred in 1434 to Bekyngton as arbiter⁸⁷; and in 1435 the abbot recovered two quit-rents from tenements in London, one by agreement, after it had been unpaid for forty years.⁸⁸

The mistakes in the Whitman case, 1433-5, were not Wheathampstead's. The archdeacon, after declaring Richard Whitman, an inhabitant of Rickmansworth, contumacious for not appearing to answer a charge of slander,⁸⁹ excommunicated him in face of his appeal to Rome and letters of protection from the Court of Arches.

The Archbishop of Canterbury naturally began proceedings against the archdeacon, who thereupon resigned his office. Wheathampstead, now left to cope with a difficult situation, invoked the goodwill of the official of the Arches, appealed in his turn to Rome and forced Whitman into submission.⁹⁰ Whatever sympathy may be felt for Whitman,⁹¹ it should be remembered that the abbot could not afford to be defied by a subject.

In the affair with the Abbot of Westminster Wheathampstead's good and bad points were alike displayed. The matters at issue were the gallows on Nomansland, which by Wheathampstead's orders had been cut down in 1427,⁹² and toll demanded in the St. Albans market and refused by the Abbot of Westminster and his men.⁹³ After the dispute had dragged on for years it was brought in 1437 before certain judges, in an unofficial capacity. When both sides had been heard Wheathampstead invited the judges to dinner and undoubtedly tried to influence them. But, although he was willing to abide by their

⁸⁶ Amundesham, *Annales*, i, 263-73. Flete and Babington were both admitted to the fraternity. Unpleasant conclusions have been drawn from the presents to Babington and Bekyngton entered in the abbot's expenses (Riley, *Introductio* to Amundesham, *Annales* [Rolls Ser.], ii, pp. xl-xli), but compensation to a man for his time and trouble is not necessarily a bribe, and when and in what circumstances the gifts were offered and accepted is not known.

⁸⁷ Amundesham, *Annales*, ii, 89-103.

⁸⁸ *Ibid.* 113-15.

⁸⁹ Whitman's account was that William Creke had entered his tenement and taken his goods, and to cover this act had charged him with defamation. He said the archdeacon intended to make him submit to Creke and this meant the loss of his tenement, and he accused the abbot of showing partiality throughout to Creke, who was his relation by marriage (Early Chan. Proc. bde. 44, no. 235).

⁹⁰ Amundesham, *Annales*, i, 369-90; ii, 7-87.

⁹¹ He gave in only after imprisonment for more than a year.

⁹² Amundesham, *Annales*, i, 14-15.

⁹³ Their goods had therefore been seized and their horses impounded by the bailiff of the Abbot of St. Albans (Amundesham, *Annales*, ii, 128-31).

RELIGIOUS HOUSES

award, his rival was not. The case therefore came into a court of law, but was not finished, Wheathampstead suspending proceedings on account of the famine.^{93a}

A plea of the Crown against the abbey for deodands⁹⁴ awakened the abbot to the disadvantageous obscurities of the charter of Henry II and the limitations of the confirmation in 1405. With the help of the Duke of Gloucester and at a cost of £82,⁹⁵ he obtained in April 1440 a patent defining these privileges and confirming to the abbot and convent the return of all writs, the goods and chattels of their men and tenants and of residents on their lands forfeited for outlawry or felony, fines for trespasses, conspiracies, &c., year day, and waste, deodands, treasure-trove, wreck, and anything that usually pertained to the king from murders or other felonies committed by their men or on their lands.⁹⁶ By securing a general pardon from the king in 1437 he astutely safeguarded himself from the consequences of infringement of the Statute of Mortmain; for he feared that his recent acquisitions were in excess of the licences granted to him.⁹⁷ These new possessions included the cell of Beaulieu, which, being likely to become burdensome to the abbey, was suppressed in 1428 by arrangement with the patron, Lord Grey de Ruthin.⁹⁸

The ordinances drawn up by the abbot after a visitation of the monastery previous to his departure for Pavia in 1423,⁹⁹ although partly in common form, suggest some carelessness of observance and indiscretion. The monks were admonished to be punctual at vespers, not to leave the quire during service in order to walk about the church and talk, nor to loiter and chatter at the vestry door; frequent requests to visit relations were discountenanced; journeys to friends were not to be made on foot; the brothers were forbidden to talk with women, or without the superior's leave to go to the nunneries near St. Albans or Redbourn; they were exhorted not to swear nor address each other discourteously in the second person singular, nor to loiter and drink, especially when they should be present in the quire; at Redbourn they were not to sit up late, and in their walks were to have an adult companion; officials were to amend their ways as regards

attire¹⁰⁰; there were besides regulations concerned with the training of the younger monks. One rule clearly expresses the abbot's distrust of secular greed—to give no room for extortion the treasure of the house was not to be shown to strangers except with the prior's leave.

Asceticism was certainly not required of the convent by Wheathampstead. He granted the manor of Borham at this time to increase their wine and pittance,¹ and obtained a papal bull substituting a fast on the vigil of St. Alban for that between Septuagesima and Quinquagesima²; in 1428 he made a beneficial change in the diet of the novices,³ and provided for the monks pittance on Sundays during the winter,⁴ in 1431 adding others on Mondays and Thursdays in summer.⁵

Important changes in administration were introduced about this time.⁶ Wheathampstead established a common chest⁷ from which loans could be made to the abbey or cells in emergencies⁸; it was to be kept by three monks nominated by the abbot with the convent's consent, and for its funds the rent of Gorham and a tenth of all gifts to the convent were set aside. At the same time a 'master of the works' was appointed⁹ to superintend and account for all repairs to the fabric; he was also to pay the money allotted for the brothers' clothing and pittance, provide torches and candles on certain festivals, and distribute the doles to be given on Wheathampstead's anniversary. To his office was assigned the property acquired between 1425 and 1431,¹⁰ the issues of

¹⁰⁰ They were not to wear tunics with fastenings forbidden by the canons, nor costly cowls and rare furs. From Wheathampstead's ordinance when president of the provincial chapter in 1429 (Amundesham, *Annales*, i, 39-40), expensive dress was a common monastic failing then.

¹ Amundesham, *Annales*, i, 116.

² *Ibid.* 159-60. The relaxation was asked on account of the difficulty in getting fish (*ibid.* 153). To the fast on the vigil of St. Alban, the convent added fasts on two other vigils (*ibid.* 183-4).

³ Amundesham, *Annales*, i, 28-9.

⁴ *Ibid.* 29.

⁵ *Ibid.* 285.

⁶ The ordinances were made on 1 March 1429-30 and ratified June 1432, after an inquiry by the pope's order (Arundel MS. 34, fol. 56-8 d.).

⁷ *Ibid.* fol. 52; Amundesham, *Annales*, i, 275-9.

⁸ Possibly the effect of the disclosures at visitations of Wymondham and Binham in 1426 (Amundesham, *Annales*, i, 205-11) may be seen here.

⁹ *Ibid.* 279-85; Arundel MS. 34, fol. 52. There had already been masters of the works in the 14th century, but they were seculars entrusted with certain definite building operations, while the master of the new ordinance was a monk who relieved the sacrist permanently of all responsibility for the fabric and some other cares.

¹⁰ For this see Arundel MS. 34, fol. 4-10, or Amundesham, *Annales*, ii, 162-8, 175-7.

^{93a} Amundesham, *Annales*, ii, 128-57.

⁹⁴ *Reg. of St. Albans*, i, 461, App. D.

⁹⁵ *Ibid.*

⁹⁶ *Cal. Pat.* 1436-41, p. 422.

⁹⁷ Amundesham, *Annales*, ii, 168-73.

⁹⁸ Lord Grey released his right of patronage to Wheathampstead and the Prior of Beaulieu on 12 May 6 Hen. VI (Arundel MS. 34, fol. 32-3), not 13 Hen. VI as is said in Amundesham, *Annales*, ii, 106. The brothers were withdrawn in 1428. (Amundesham, *Annales*, i, 29-30.)

⁹⁹ Amundesham, *Annales*, i, 101-15.

A HISTORY OF HERTFORDSHIRE

which were to be deposited in the common chest.

The convent does not seem to have been very tractable. They manifested decided disapproval of a sale of land by the abbot to Sir John Cornwall in October 1429, two monks absolutely refusing their consent¹¹; and possibly in connexion with this incident there were shortly afterwards mutinous grumblings against the abbot, for which they had to ask his pardon.¹² Some, again, murmured rebelliously at Wheathampstead's ordinances for Redbourn in 1439.¹³ These regulations provided for a proper rendering of the services, and required the monks to avoid visiting doubtful places on their way to the priory, to abstain from late hours, and drinking or other excesses which unfitted them for their religious duties, and to employ their leisure in reading or study. Several of the rules should not even have been necessary and the successful opposition to them, for Wheathampstead, in view of his projected retirement, forbore to press them, gives an unfavourable idea of the standard of conduct at the monastery. It certainly makes incredible the annalist's statement that the house then enjoyed high repute 'for the brothers' sober and religious way of life.'¹⁴

Of individual efforts of the convent there is not much sign. The abbot's zeal against Lollardy¹⁵ did not apparently inspire his monks to combat heresy in treatises or sermons. Wheathampstead wrote¹⁶ and caused to be written more books for the brothers, it is said, than any other Abbot of St. Albans,¹⁷ but with disappointing result as regards original work by the convent. The *Annales* known as John Amundesham's in the inflated, tiresome manner of Wheathampstead whose deeds they eulogize, are a poor exchange for the straightforward narrative of the *Gesta Abbatum*; while the one historical production is the 'Chronicon Rerum Gestarum,'¹⁸ from its style probably a mere diary. It is interesting to see that some atten-

tion was now bestowed on music, hitherto apparently neglected, for a monk in 1421 had deserted to Christchurch, Canterbury, simply to enjoy opportunities of studying that art.¹⁹ The appointment of two salaried singing-men here in 1423,²⁰ the suspicion of the Bishop of Durham that a singing-boy had been enticed from his chapel to St. Albans,²¹ and the purchase of new organs for the conventual church in 1428,²² all point to Wheathampstead's endeavours to improve the services on the musical side.

Wheathampstead resigned on 26 November 1440.²³ The reasons for the step can only be hazarded, but they were probably not so much declining health, shyness and anxieties endured in the past²⁴ as difficulties anticipated in the future through the waning of the Duke of Gloucester's power. His expenditure for the benefit of the house had been from £5,000 to £6,000²⁵: over £1,400 had been spent in buying and securing property in mortmain²⁶; about the same sum in repairs and improvements to the manors, the town of St. Albans and the college at Oxford²⁷; £891 at the abbey²⁸; £142 on building a small chapel in the church and on ornaments for it and the Lady chapel²⁹; £641 on vestments and plate for the church³⁰; over £100 on plate for domestic use; £326 in presents, principally for friends of the monastery.³¹

John Stoke, Prior of Wallingford, was chosen in Wheathampstead's place.³² He very

¹⁹ Amundesham, *Annales*, i, 89.

²⁰ Ibid. 106-7. The abbot tried in 1439 to introduce paid singers at Redbourn also.

²¹ Wheathampstead's letter of excuse to the bishop c. 1422-4 (*Reg. of St. Albans*, ii, 406-8).

²² Amundesham, *Annales*, i, 25.

²³ Ibid. ii, 233-45.

²⁴ Ibid. 233.

²⁵ He himself estimated it at over 10,000 marks (ibid. 236).

²⁶ Arundel MS. 34, printed in Amundesham, *Annales*, ii, 264-7, App. A.

²⁷ £680 on the manors, £665 on the Great Gate and repair of tenements at St. Albans, £108 in making a library and little chapel at Oxford (ibid. 261-4).

²⁸ Ibid. 257-8. In rebuilding the infirmary and its chapel and constructing a large room for the abbot.

²⁹ Ibid. 258.

³⁰ Ibid. 258-9. A chasuble, six tunics and twelve copes made of material given by Eleanor Hulle cost £200, twelve copes of another suit £103, twelve copes of a third suit £50.

³¹ Two gilt basins given to Queen Katharine, £55; others to the Duchess of Bedford, £25; silver cups to Sir William Babington and Thomas Bekyngton for favours shown to the monastery, £5 and £6 13s. 4d.; one to the Sheriff of Hertfordshire for favours shown in the plea against the Abbot of Westminster, £4 6s. 4d.; three books given to the Duke of Gloucester, £10; a book of astronomy for the Duke of Bedford, £3 6s. 8d., &c., &c. (ibid. 255-7).

³² *Cal. Pat.* 1436-41, p. 527.

¹¹ Amundesham, *Annales*, i, 43.

¹² Ibid. 45.

¹³ Ibid. ii, 203-12.

¹⁴ Ibid. 233.

¹⁵ He took proceedings against the Lollards at a synod held at St. Peter's in 1427, attended the Bishop of Lincoln's inquisition in 1429 and was associated with the Bishop of Ely in another in 1431 (Amundesham, *Annales*, i, 13, 34-5, 64).

¹⁶ Of his many works, none of which is published, the chief were the 'Granarium de Viris Illustribus,' in four volumes, and the 'Palearium Poetarum.'

¹⁷ *Reg. of St. Albans*, i, 462, App. D. A good deal of copying was probably done in the scriptorium, for the abbot borrowed (ibid. ii, 445-7, 456-7, 458, App. E) and made presents of books (Amundesham, *Annales*, ii, App. A).

¹⁸ Harl. MS. 3775.

RELIGIOUS HOUSES

soon began to wrangle with his predecessor, grudging apparently the provision made for him. The Duke of Gloucester was appointed arbitrator between them on 6 January 1442 and on 1 September delivered his award³³: Wheathampstead was to surrender all estate in Tyttenhanger, and was to receive for life Park Manor and lands in Radwell; he was to have the house near the infirmary which he had rebuilt and he might go where he pleased except to Tyttenhanger Manor; a certain amount of plate was also allotted to him. It was probably fortunate for the ex-abbot that Duke Humphrey was then making arrangements for the celebration of his anniversary at St. Albans. In June 1441 he had obtained the royal licence to give the alien priory of Pembroke to the abbey for this purpose,³⁴ but it was not until 1 August 1443 that he actually granted the property.³⁵ The ordinances, drawn up presumably at this time, provided for daily masses at his sepulchre and services and distributions on his anniversary at a cost of £44 17s. 2d. a year and for the annual payment of £60 to the relief of the convent's kitchen.³⁶ The duke died on 23 February 1447 and was buried in the tomb already made for him in St. Albans.³⁷ Some jewels belonging to the abbey, which had been in his keeping, now came into the hands of the king, who presented them to his colleges of Eton and Cambridge.³⁸ The abbot and convent put in their claim, and it seems likely that there was a connexion between these events and the grant of extensive privileges made to the abbey by the king in November of that year. On 18 December 1448, however, avowedly in compensation for the loss of their goods,³⁹ they received acquittance of £20 in every clerical tenth until the sum of £600 should be reached, ratification of the duke's gift of Pembroke Priory and of their possession of the churches of Tenby and Manorbeer, co. Pembroke, appropriated under a licence of 1445,⁴⁰ and confirmation of the Letters Patent of 1440 and of the recent grant.

In dealing with his monks the abbot was not successful. One only actually apostatized, but eight others escaped from his control by procuring bulls of emigration or promotion, among

them Henry Halstede, Prior, and Robert Morpath, Cellarer of Wallingford.⁴¹ The Prior of Belvoir in 1449 secured himself from removal without reasonable cause,⁴² evidently as a precaution against such action on Stoke's part as had just resulted in the loss of the cell of Wymondham to the abbey. Stephen London had been Archdeacon of St. Albans, and Stoke, who disliked him for telling him too plainly of his faults, had made him Prior of Wymondham to get rid of him and then after a few months had arbitrarily recalled him.⁴³ The patron, Sir Andrew Ogard, espoused London's cause, and obtained bulls which raised the priory to an abbey in 1449 and made it independent.⁴⁴ The petty spitefulness shown by Stoke⁴⁵ to London leads to the conclusion that the defections in his time were due to his faults, not to his reforming zeal. It is said that Stokes was avaricious⁴⁶ and that in his time learning⁴⁷ and preaching were neglected at the monastery,⁴⁸ but it must be remembered that the information comes from Wheathampstead's eulogist and may be biased.⁴⁹ The difficulty is to know how much allowance to make for prejudice, especially as regards the story⁵⁰ told about Stoke's favourite, William Wallingford,⁵¹ the official-general.^{51a} Stoke on his death-bed informed the prior and others that he had saved

⁴¹ *Reg. of St. Albans*, i, 146-7. Stoke on 20 Oct. 1448 asked for the arrest of the last two as apostates (Chan. Warr. [Ser. 1], file 1759, no. 35). After Stoke's death Halstede sought readmission to the convent, and promised if he were made Prior of Bingham to pay the debts of the house and rebuild the dormitory. It needed, however, strong persuasion and remonstrance on Wheathampstead's part to make the monks agree to his return (*Reg. of St. Albans*, i, 138-42).

⁴² *Cal. Pat.* 1446-52, p. 247.

⁴³ *Reg. of St. Albans*, i, 148-54.

⁴⁴ His pardon for procuring papal bulls is dated 16 March 1449 (*Cal. Pat.* 1446-52, p. 260).

⁴⁵ It appears again in his sale of the missal given by Wheathampstead to his chapel (*Reg. of St. Albans*, i, 427).

⁴⁶ *Ibid.* 116.

⁴⁷ For years there was no learned master to teach the youths in the cloister, and scarcely a scholar was sent to the university (*ibid.* 24).

⁴⁸ Under him the monks ceased to preach to the people during Lent (*ibid.* 25).

⁴⁹ The ill-feeling between Stoke and Wheathampstead had not been removed by the settlement of 1442. It tells against Stoke that Wheathampstead was befriended by his former opponent Alwick, who had now become Bishop of Lincoln (*Amundesham, Annales*, i, 364, n. 7).

⁵⁰ *Reg. of St. Albans*, i, 102-35.

⁵¹ Abbot Gasquet says (*Abbot Wallingford*, 6-7) that from the author's description the Wheathampstead Register cannot be regarded as official.

^{51a} Wallingford held five offices, including that of archdeacon.

³³ Arundel MS. 34, fol. 82 d., printed in Amundesham, *Annales*, ii, 278-89, App. B.

³⁴ *Cal. Pat.* 1436-41, p. 567.

³⁵ Chart. R. 27-39 Hen. VI, no. 40.

³⁶ Cott. MS. Claud. A viii, fol. 195, printed in Dugdale, *Mon.* ii, 202.

³⁷ *An Engl. Chron. of Reigns of Ric. II-Hen. VI* (Camd. Soc.), 117-18. It cost Abbot Stoke and the convent £433 6s. 8d. (Dugdale, *Mon.* ii, 202).

³⁸ *Reg. of St. Albans*, i, 27; Chart. R. 27-39 Hen. VI, no. 40.

³⁹ Chart. R. 27-39 Hen. VI, no. 40.

⁴⁰ *Cal. Pat.* 1441-6, p. 356.

A HISTORY OF HERTFORDSHIRE

1,000 marks,⁵² of which his official-general and Thomas Wallingford, his senior chaplain, had charge. When he was dead the two brothers produced 250 marks and denied all knowledge of the rest. The election resulted in the return to power of Wheathampstead, who was informed of the episode, but said nothing for a time. When, however, Wallingford presented his first accounts at Michaelmas 1453, it was discovered that although during Stoke's time seasons had been good, much wood sold, many serfs manumitted and extreme parsimony exercised at the monastery, and under the new rule expenses had been kept down, yet the granaries were empty and debts amounted to 600 marks and more. The abbot showed his surprise and dissatisfaction, expressed his opinion to the convent that there was dishonesty somewhere, and told Wallingford that unless he could manage better he must be removed. Wallingford then manipulated his accounts so that there appeared to be fewer debts and £160 in hand; but when required soon afterwards to make certain payments he said recourse must be had to borrowing, telling the abbot that the supposed ready money had really been expended in repairs, and informing others that he had given most of it to the abbot. Wheathampstead thereupon accused him of peculation and ordered him to surrender his unlawful gains, which he heard amounted to £1,000, or he would proceed against him. Wallingford, however, promised through an intermediary to pay everything necessary, clear off the debts, and within two years have £200-£300 in the treasury, and was allowed to retain his post.

In what is apparently another version of the tale, it is related that the abbot, finding that the official-general and the senior chaplain said nothing about the 750 marks, began to suspect them, and at last questioned them on the subject; both declared they had not had the money, and Wheathampstead, though convinced that they were lying and telling them so, let the matter drop.⁵³

The story can hardly be dismissed as entirely fiction.⁵⁴ There must have been at least unpleasant rumours about Wallingford, possibly he was actually charged with dishonesty. His innocence is also not proved by his retention in office. That may have been a matter of expediency. He had a party in the convent⁵⁵

⁵² The account in the *Registers* (i, 115-17) is certainly unfair to Stoke in implying that he had a secret hoard. He had apparently saved out of his revenues as other abbots had done, to leave money for pious objects.

⁵³ *Reg. of St. Albans*, i, 119-22.

⁵⁴ Abbot Gasquet, however, considers it an absolute invention (*Abbot Wallingford*).

⁵⁵ *Reg. of St. Albans*, i, 104. Some had wished to make him abbot (*ibid.* 5).

and influential friends outside⁵⁶; moreover, he could best put right the financial difficulty he had created. The affair is discreditable to St. Albans in any case, for if Wallingford was blameless, one or more of the monks must have been guilty of gross slander.

In 1454 the monastery was threatened with the loss of Pembroke Priory through Parliament's confirmation of the earldom of Pembroke to Jasper Tudor,⁵⁷ and of Burston through Charlton's action while Speaker of the Commons,⁵⁸ but Wheathampstead managed to avert both dangers.⁵⁹

St. Albans on 22 May 1455⁶⁰ was the scene of one of the most important battles of the Civil War. The town was pillaged by the northern followers of the victorious Duke of York; the abbey, however, was spared.⁶¹ Its escape, ascribed by the chronicler to the fact that the king had not by lodging there compromised its neutrality,⁶² was probably due to the monastery's connexion with the late Duke of Gloucester and its supposed inclination in consequence to the side of the Duke of York, Humphrey's political heir. If Wheathampstead could not rely at all on the duke's favour, he merits greater praise for doing what no one else dared, asking the duke to allow his former enemies to be buried.⁶³ Permission was immediately given, and the bodies of three Lancastrian nobles were brought in by the monks and interred in the Lady chapel.⁶⁴

The Act of Resumption of 1456 caused the abbot some anxiety: the prior sent to the Parliament to guard the abbey's interests as to the clerical tenth, had a proviso inserted in the Act, but discovered afterwards that it was invalid; the end was only achieved by a fresh grant in November 1457.⁶⁵

The reconciliation between the two parties on 24 March 1458 was of direct benefit to the monastery in so much as the Yorkists were to pay £45 a year to the convent for masses for the Lancastrians buried at St. Albans.⁶⁶ The king seems to have come immediately afterwards to the abbey to spend Easter and stayed three weeks.⁶⁷ On 20 June he came again for

⁵⁶ *Reg. of St. Albans*, i, 112. He asked the Earl of Pembroke and Lord Sudeley to intercede for him.

⁵⁷ *Ibid.* 92-4.

⁵⁸ *Ibid.* 136-7.

⁵⁹ The first through one of the late Duke of Gloucester's servants.

⁶⁰ *Paston Letters* (ed. 1896), i, 327-31.

⁶¹ *Reg. of St. Albans*, i, 171-2.

⁶² *Ibid.* 173.

⁶³ *Ibid.* 175-6.

⁶⁴ *Ibid.* 177-8.

⁶⁵ *Ibid.* 250-68.

⁶⁶ *Ibid.* 295-302; *An Engl. Chron. of Reigns of Ric. II-Hen. VI* (Camd. Soc.), 77.

⁶⁷ Cott. MS. Nero, D vii, fol. 73.

RELIGIOUS HOUSES

six days, and on 29 August for nearly six weeks.⁶⁸ His offerings⁶⁹ on these occasions undoubtedly did not represent the whole advantage derived by the house: it was by royal letters that John Cheyne this year was induced to make terms with the abbot over a rent from land in Chalfont St. Giles, which he had refused to pay for ten years.⁷⁰ The next year Henry broke his journey north here on 7 May, and at his departure presented to the abbey his best robe, redeemed by the treasurer at once for 50 marks.⁷¹

John de Hertford's days are recalled by the king's visits and by the way the convent was kept in touch with important outside movements and affairs. To St. Albans in 1457 came the Hungarian priest with news of the defeat of the Turks by Hunyadi⁷²; at St. Albans kindly hospitality was extended to the three monks sent from Cluny in 1458 to petition the king to restore to them the houses of their order⁷³; and here in 1459 the pope's legate made a short stay when on his way to seek the king's support of the proposed Council at Mantua.⁷⁴

This side of the abbey life seems to end abruptly with the second battle of St. Albans, 17 February 1461, and the terrible blow then inflicted on the prestige of the monastery. The abbot begged the king to save the town and abbey from spoliation, but Henry's proclamation forbidding the troops to plunder was unavailing; and if the queen had power to control her forces she lacked the will.⁷⁵ The northerners sacked the town, emptied the convent's granaries and cellars, and departed leaving desolation behind them. So complete was the destitution that the monks had to separate for a time, and the abbot, with a diminished household, betook himself to the seclusion of Wheathampstead.⁷⁶ It is not surprising that the author of the

Register welcomed the accession of Edward IV. The abbot's first care in the new reign was to get a re-grant of Pembroke Priory, which would otherwise have been lost under the Act of Resumption of 1461, and this he secured in December⁷⁷ through the friendly offices of the chancellor, George Nevill.⁷⁸ In November 1462 he also obtained charters similar to those of 1440 and 1447.⁷⁹ Wheathampstead, who had probably been long in bad health, died in January 1465⁸⁰ much regretted by the monks.⁸¹ He had treated the convent generously in acquitting them of a debt of over £220; and he appears to have been considerate to his impoverished tenants.⁸²

He made additions to the property of St. Albans, which attest his thoughtfulness for the abbey's welfare.⁸³ He also carried out his former intention of building a library,⁸⁴ made a new bakehouse, apparently a model of its kind,⁸⁵ and put stained glass in the cloisters.⁸⁶ The chapel of St. Andrew was entirely rebuilt by him,⁸⁷ and the ornaments of the church increased, notably by some works of art in silver-gilt.⁸⁸ The purchase of an organ, which from its cost, viz., £50,⁸⁹ was immeasurably superior to any instrument hitherto set up at the abbey, illustrates again Wheathampstead's cult of music.

William Albone, the prior, whose election had been proposed in 1451, now became abbot.⁹⁰ He was a native of St. Albans, and was reputed a gifted and cultivated man, generous in character and works.⁹¹ As known and acceptable to various great persons he had been entrusted by Wheathampstead in 1455 with the negotiations for the exemption of St. Albans from the Act of Resumption.⁹²

He seems to have been interested in learning: in December 1465 he was asked to find a prior for the Benedictine students at Cambridge⁹³;

⁶⁸ Cott. MS. Nero, D vii, fol. 74.

⁶⁹ The first and third time he gave a robe of purple, and on the Feast of St. Alban a picture or relief of the Virgin on gold ornamented with pearls and precious stones (*ibid.*).

⁷⁰ *Reg. of St. Albans*, i, 308-11.

⁷¹ Cott. MS. Nero, D vii, fol. 74 d. The Registers record no royal visits in 1458, and say of the visit in 1459 that it occurred at *Easter*, and that the king on leaving the abbey went to London (*ibid.* ii, 323-5). But there seems no reason to doubt the accuracy of the Golden Book: its statement that the king was on his way north 7-8 May 1459 agrees with the fact that he was at Northampton on 14 May (*Paston Letters* [ed. 1896], i, 437); and from the Registers themselves it may be gathered (i, 317-18) that some time during 1458 Henry was staying at St. Albans.

⁷² *Reg. of St. Albans*, i, 268-79.

⁷³ *Ibid.* 317-22.

⁷⁴ *Ibid.* 330-6.

⁷⁵ She herself took one of the monastery's jewels (*ibid.* 390-7).

⁷⁶ *Ibid.* 399.

⁷⁷ *Cal. Pat.* 1461-7, p. 120.

⁷⁸ *Reg. of St. Albans*, i, 417.

⁷⁹ Chart. R. 2 Edw. IV, m. 24, printed in Clutterbuck, *Hist. and Antiq. of Herts.* i, App. i. Other charters are confirmed, but these are made anew without reference to the original grants.

⁸⁰ *Cal. Pat.* 1461-7, p. 386.

⁸¹ *Reg. of St. Albans*, i, App. D.

⁸² *Ibid.*

⁸³ They were made to avoid contests, such as those with Chilterne and Flete.

⁸⁴ *Reg. of St. Albans*, i, 423-4.

⁸⁵ *Ibid.* 424. In the opinion of many it was the best in the whole kingdom.

⁸⁶ *Ibid.* 427.

⁸⁷ *Ibid.*

⁸⁸ *Ibid.* 425, 429. One which represented the Saviour enthroned with saints on either side cost £146.

⁸⁹ *Ibid.* 432.

⁹⁰ *Cal. Pat.* 1461-7, p. 345.

⁹¹ *Reg. of St. Albans*, i, 475.

⁹² *Ibid.* 259. ⁹³ *Ibid.* ii, 53-5.

A HISTORY OF HERTFORDSHIRE

and in 1469 he presented a young man, whom he had educated from a boy, to the living of St. Michael's that he might have the means to study at Oxford.⁹⁴

Visitations of the abbey were made by the Abbot of Peterborough in 1465, and by the Abbot of Eynsham in 1468,⁹⁵ but the results are not recorded. Albone's gifts to the church were valued at 600 marks,⁹⁶ and he acquired property for the abbey worth £66 a year⁹⁷; but on the other hand at his death in July 1476 he left debts amounting to £1,830.⁹⁸

The burden on the house may have been the determining cause of the unanimous election of William Wallingford,⁹⁹ who had a gift for finance. If there had been any scandal connected with him, it was many years before, and had certainly made no difference to his career: he had continued to hold office under Wheathampstead, and had been made prior by Albone.¹⁰⁰ He had to his credit the accomplishment of expensive works and payment of debts,¹ and the education of ten young religious at his own cost.²

He inaugurated his abbacy with much splendour, giving two great banquets, one at Tyttenhanger, and another at St. Albans, which he entered accompanied by a train of 440 servants and tenants.³ Outwardly the abbey might be unchanged. In reality its position had been much altered by the Civil Wars, so that for its security the conciliation of those in power became an ever-increasing necessity. This seems the meaning of the grants of nominations to benefices begun by Wheathampstead⁴ and continued by Albone and Wallingford,⁵ and the bestowal of the office of steward on one of the dominant political faction.⁶ The same

⁹⁴ *Reg. of St. Albans*, ii, 83.

⁹⁵ *Ibid.* 47-9, 76-9.

⁹⁶ *Ibid.* i, 475, App. D. Among them were seven copes of purple velvet embroidered with golden flowers, which he presented at the beginning of his rule in honour of the Seven Joys of Mary, and six missals and six graduals for the choir.

⁹⁷ *Ibid.*

⁹⁸ *Ibid.* 477, App. D.

⁹⁹ *Ibid.* 142-58.

¹⁰⁰ On 18 March 1464 (*ibid.* ii, 50).

¹ *Ibid.* i, 476-7, App. D.

² *Ibid.* 476.

³ *Ibid.* ii, 159-60.

⁴ In 1464 he gave George Nevill, the chancellor, the next nomination to Great Stanmore Church (*ibid.* 21-2).

⁵ Albone made six such grants (*ibid.* 58, 60-1, 97, 106, 111, 198), Wallingford seventeen, of which three occurred in the first four months of his rule (*ibid.* 161, 162-3, 164, 166-7, 167-8, 183-4, 197-8, 202, 223, 224, 227, 238, 246, 255, 257, 258-9, 282).

⁶ Lord Hastings received this office for life in 1478 (*ibid.* 199), and after his execution in June 1483 it was given to William Catesby (*ibid.* 266-7).

policy caused Wallingford's confirmation of Richard Lamplew as Prior of Hertford for life in 1484 at the request of the Chancellor, Chief Justice, Sir William Say and William Catesby.⁷ It may also account in part for Wallingford's conduct with regard to Tynemouth Priory. The abbot promised the Duke of Gloucester and Sir John Say that Nicholas Boston, Archdeacon of St. Albans, should be Prior of Tynemouth when John Langton died or retired⁸; on 15 March 1477-8 he removed Langton for rebelling against a visitation,⁹ and in May made Boston prior for life.¹⁰ On 8 May 1480, as the result of disclosures at a visitation held by Langton and William Dixwell,¹¹ Prior of Binham, as it was said, Boston was deposed by the abbot and replaced by Dixwell.¹² In September Wallingford authorized Dixwell to inquire into Boston's conduct, and after a short interval requested the Bishop of Durham to arrest the ex-prior as an apostate.¹³ About ten weeks later he had to order another visitation of the priory owing to the mutual recriminations of Dixwell and Boston.¹⁴ On 8 March 1482-3 Dixwell, again Prior of Binham, accused himself of having procured Boston's deposition and destroyed the deed giving him his post for life, and asked that his opponent might have a new grant of his office in perpetuity.¹⁵ The object of the confession seems to have been to exculpate Wallingford for the past proceedings. Boston, however, must still have felt unsafe until the convent's seal as well as the abbot's was affixed to the fresh grant, and on 19 November this was done at the request of King Richard.¹⁶

The abbot's course looks bad from any point of view. The discovery of Langton's unfitness just then was too convenient not to be suspicious, and if his removal was warranted, he was unsuitable as a visitor. For the same reason Boston's deprivation and re-appointment cannot both be justified; and in any case he was treated most unfairly. Moreover,

⁷ *Reg. of St. Albans*, ii, 268.

⁸ *Ibid.* 165.

⁹ *Ibid.* 186-7.

¹⁰ *Ibid.* 184.

¹¹ Wheathampstead in January 1454 had asked for Dixwell's arrest because he was wandering about like a vagabond and apostate (Chan. Warr. [Ser. 1], file 1759, no. 36; *Reg. of St. Albans*, ii, 16-17).

¹² Boston was deposed 8 May, and on 17 May 'of his own free will' resigned the priory (*Reg. of St. Albans*, ii, 214-15).

¹³ *Ibid.* 233-4.

¹⁴ As to losses of the house through them (*ibid.* 239). Boston had apparently been inconsiderate about expenses (*ibid.* 182).

¹⁵ *Ibid.* 254.

¹⁶ The king had promised to contribute £100 to the priory (*ibid.* 262-3).

RELIGIOUS HOUSES

Wallingford was guilty either of using Dixwell to oust Boston by indefensible means, or of entrusting authority to a man convicted on his own confession of intrigues for his own advantage.

It is unlikely that the weakness or lack of principle so manifest here was displayed in this instance only, and the easiest explanation of the list of the abbot's good works attested by the prior and convent in August 1484¹⁷ is that it was intended as a defence against actual or anticipated attacks on Wallingford's administration.¹⁸

In April 1487 John Rothbury, the archdeacon, went to Rome to ask for certain additional privileges: among other things that the abbot and his successors might confer holy orders on monks of the abbey and cells, and on seculars of their jurisdiction, and also confirm children born within that area, and that the exemption of St. Albans might be declared to extend to pleas in the Court of Arches.¹⁹ This attempt to secure absolute ecclesiastical independence, unsuccessful owing to the opposition of the cardinals and bishops,²⁰ argues unmistakable apprehension of episcopal and archiepiscopal activities, and may thus afford a clue to the date of the suit brought against the abbot in the Court of Arches by the Prioress of Sopwell,²¹ to be referred to later. Her case subsequently came before the archbishop as Chancellor, and undoubtedly helped to give him an unfavourable opinion of Wallingford and his monks. Some move on Morton's part, probably his warning to the abbot to amend what was wrong,²² made Wallingford think the abbey's exemption in danger, for on 6 February 1490 he procured a papal bull which ordered the archbishop to protect the privileges of St. Albans.²³ Morton, however, on 6 March was commissioned by papal bull to visit exempt monasteries, and under its powers he wrote on 5 July to the abbot threatening him with a visitation unless within thirty days the abuses reported to exist at St. Albans²⁴ were reformed. The abbot was accused of simony and usury, and of being so remiss in his rule and in his

administration of goods that regular observances had been given up, hospitality and alms had decreased, and daily diminished, and not a few of the monks led dissolute lives, defiling even God's temples by intercourse with nuns; the abbot is said to have admitted as a nun into the house of Pré and made prioress a married woman named Helen Germyn who had previously left her husband to live in adultery, and he had taken no measures against her guilty intimacy with Thomas Sudbury,²⁵ one of his monks; he had also not corrected other monks who resorted to the nunnery for immoral purposes; he had changed the Prioresses of Sopwell at his caprice, and both here and at Pré had deposed the good and religious and promoted the idle and vicious; he had moreover appointed as wardens of those houses monks who had dissipated their goods; he had dilapidated the property of the monastery and cells, sold the jewels and cut down wood to the value of 8,000 marks and more; the monks neglected divine service; some consorted with harlots even in the precincts of the abbey, others to pay for promotion had stolen the jewels of the church and robbed the very shrine and had not been punished.

On 11 July the abbey's proctor represented to the pope that St. Albans had peculiar privileges as to exemption from visitation, and asked and obtained his protection for the monastery pending its appeal.²⁶ The case was submitted to two papal chaplains, and by their advice Morton on 30 July received special faculties to deal with St. Albans.²⁷ Whether he acted on them, however, is not known.²⁸ In the absence of the information that the account of an inquiry²⁹ or injunctions would have afforded, the truth or falsehood of the charges in the letter or 'monition' remains a question of inference and probability.

Abbot Gasquet³⁰ considers that the actual facts about Wallingford and the abbey at this

¹⁷ He was almoner in 1485 (*Reg. of St. Albans*, ii, 273).

¹⁸ Gasquet, *op. cit.* 51-2.

¹⁹ *Ibid.* 52-3. The statement in the Obit Book (printed in *Reg. of St. Albans*, i, 478, App. D) that Wallingford won a just victory in his contest with the archbishop, and preserved all the privileges of the abbey inviolate, means, therefore, not that he prevented a visitation, but that he secured an acknowledgement of the abbey's peculiar and extraordinary immunities.

²⁰ Dr. Gairdner thought it probable that the visitation took place ('Archbishop Morton and St. Albans,' *Engl. Hist. Rev.* xxiv, 321). Abbot Gasquet (*op. cit.* 59) thinks it more likely that Morton did not visit, but was satisfied with the testimony of the community that Wallingford had been slandered.

²¹ Froude (*Short Studies*, iii, 127) assumed that Morton's letter was the result of an official inquiry, but he was quite mistaken.

²² *Op. cit.*

¹⁷ Cott. MS. Nero, D vii, printed in *Reg. of St. Albans*, i, App. D.

¹⁸ See Dr. Gairdner, 'Archbishop Morton and St. Albans,' *Engl. Hist. Review*, xxiv, 95. Abbot Gasquet thinks it was occasioned by the convent's discovery of the accusations against Wallingford contained in what purported to be Wheathampstead's Register (*Abbot Wallingford*, 30-2).

¹⁹ *Reg. of St. Albans*, ii, 287-9.

²⁰ *Ibid.* 289.

²¹ Early Chan. Proc. bdle. 181, no. 4.

²² He says in his letter of 5 July that he had admonished him shortly before (Wilkins, *Concilia*, iii, 632).

²³ Gasquet, *Abbot Wallingford*, 50.

²⁴ Wilkins, *Concilia*, iii, 632.

A HISTORY OF HERTFORDSHIRE

period make the charges incredible. He relies upon the assumption that Wallingford was good because he erected the beautiful high altar screen at the abbey, which is no evidence of moral character; that he fostered education, when he really only barely fulfilled the abbey's obligation; that the inquiries at Pré and Sopwell in 1480 were thorough, but of this there is no evidence; that he was appointed in 1480 visitor of the Benedictine houses of the Lincoln diocese, which only shows that he was of good fame at that particular date. He thinks that the charges of the monition are so sweeping that they suggest the purely formal attribution of crimes in a general pardon; and says further that it would have been impossible to read in public the eulogy of Wallingford contained in the Obit Book if it had been untrue and he had been a villain and spendthrift as he is sometimes depicted.

But the actual ground for one of Morton's charges appears in a petition in Chancery.³¹ Elizabeth Webbe, the Prioress of Sopwell appointed in March 1480-1, had brought a suit in the Court of Arches for unjust removal and had won; on reassuming her position she had been beaten by the archdeacon's deputies and thrown into prison. There was evidently foundation also for the report about Pré, for shortly before Michaelmas Helen ceased to be prioress,³² and her successor seems to have been chosen from Sopwell.³³ These two cases are a gauge of the credibility of the other accusations. The changes at Pré, indeed, as showing the need for reform at the nunnery are a presumption against the innocence of the monks who were said to share the nuns' guilt. This was not the only time the monks had been mentioned in connexion with the communities of women near the abbey. Years before Wheat-hampstead had had to forbid visits without leave to these nunneries.³⁴ With relaxation of discipline, therefore, trouble in this direction might be expected. Wallingford, as the Tynemouth affair proves, was to say the least careless about the fitness of those to whom he gave office, so that it is very unlikely that the monks were kept under proper control. It need hardly be said that ill-considered appointments to office made the maladministration of the dependent houses probable.

The actual sins of commission attributed to him are usury, simony and waste of the abbey's property for immediate gain. Years before, it may be observed, the author of the so-called register had declared him guilty of usury and peculation. But putting this aside, he had been

accused in Chancery of sharp practice and dishonesty. A certain William Browning had said that the evidence of his holding had been erased from the Court Rolls so that the abbot might seize his lands³⁵; in another instance a lease had been granted by Wallingford to Edward Leventhorp, with Lord Hastings as trustee, and after the death of the two men the abbot tried to get the lease from Lady Hastings to the detriment of the owner, the lessee's former wife³⁶; proceedings against Wallingford were also instituted by the executors of a will about some goods which had been deposited by the testator in Pré nunnery, and had been seized by the archdeacon and kept by the abbot.³⁷

It will be generally allowed that a man who laid himself open to this kind of charge gave cause for the belief that he had no scruples where his own profit was concerned. As to the notice of him in the Obit Book,³⁸ it describes what he had done for the abbey as archdeacon, prior, and kitchener, then relates that as abbot within fourteen years he had paid his predecessor's debts, made the screen valued at 1,100 marks, finished the chapter-house at a cost of £1,000, expended £100 on the church, £100 on the endowment of a weekly mass in honour of the name of Jesus, £60 on making a mitre and two pastoral staves, £100 on building his chapel and sepulchre; he had also incurred heavy expenses in defence of the abbey's immunities against the Archbishop of Canterbury; yet in spite of all this he left the monastery free from all debt. These were works for which the convent owed him praise; but they do not make his neglect of discipline and the consequent disorders at St. Albans impossible, nor preclude his raising money by unlawful or wasteful methods.

Wallingford appears to have died just before 20 June 1492.³⁹

Of Thomas Ramryge,⁴⁰ who succeeded him, it is almost impossible to form a clear estimate. A very unfavourable opinion of him might be drawn from various petitions in Chancery.

³⁵ Early Chan. Proc. bdl. 54, no. 387. The case occurred either in 1476 or 1483-5.

³⁶ Ibid. bdl. 66, no. 46. The date of this petition is 1483-5.

³⁷ Ibid. bdl. 97, no. 6. This case happened when Morton was chancellor.

³⁸ Printed in *Reg. of St. Albans*, i, App. D.

³⁹ The abbey was already vacant on 20 June (Add. Chart. 34350), but the *congé d'élire* was not given until nine days later (Pat. 7 Hen. VII, m. 3). Abbot Gasquet first pointed out the mistake in Dugdale's *Mon.*, where Wallingford's death is dated 1484 (*Engl. Hist. Rev.* xxiv, 92).

⁴⁰ He is mentioned in 1476 as third prior (*Reg. of St. Albans*, ii, 142), in 1480 as sub-prior (ibid. 239), and in 1484 as prior (ibid. i, App. D).

³¹ Early Chan. Proc. bdl. 181, no. 4.

³² Mins. Accts. Hen. VII, no. 275.

³³ See below, St. Mary de Pré.

³⁴ See above, p. 401.

RELIGIOUS HOUSES

Between 1493 and 1500 John Harpesfield accused the abbot of detaining from him documents relating to the entail of Harpesfield Manor⁴¹; Robert Newbury said that he had been deprived without cause of the post of keeper of the gaol of the liberty and porter of the abbey conferred on him for life in 1484⁴²; and Ralph Ferrers, master of St. Julian's, complained that Ramryge, in order to put him out of the hospital, had asked to see his letters of collation and refused to give them back, and now detained from him the revenues of his house⁴³; in 1500 or 1501 the Prioress and nuns of Sopwell declared that the warden of their house had for a bribe altered a lease to their disadvantage.⁴⁴

Yet in two out of the three cases brought against Ramryge personally, right may not have been on the plaintiff's side. According to the abbot, Newbury had been guilty of misdemeanours in his office, and if so his removal was necessary for the sake of the abbey.⁴⁵ For the attempted deprivation of Ferrers, dilapidation was the alleged⁴⁶ and probably the real cause.⁴⁷ But if Ramryge's aim was justifiable, neither his methods nor his judgement can be commended. He seems to have acted under the advice of a Dr. William Robinson, to whom he had promised the post if Ferrers could be ousted. The result, as far as he himself was concerned, was the suit in Chancery brought by Ferrers, who remained in possession until his death, and proceedings against him later in the Star Chamber for riot on Robinson's accusation.⁴⁸

Henry VII arranged in 1504 for the perpetual observance of his anniversary at the abbey⁴⁹; but as he founded obits of the kind

in seventeen other religious houses,⁵⁰ he showed in this matter no special favour to St. Albans.

Of Ramryge's activities and administration there is not much definite information. He undoubtedly bestowed some attention on the church and the services: he built a beautiful chapel which still exists, and was responsible also perhaps for paintings in the church⁵¹; and during the early part of his abbacy the celebrated musician Robert Fairfax is said to have been organist at the monastery.⁵²

The abbot was apparently straitened for money in 1511, since he was among those then put in suit for non-payment of debts to the late king.⁵³ Financial difficulties⁵⁴ were conceivably one reason why Cardinal Wolsey, who on 2 June 1519 had been made legate in visitor by the pope,⁵⁵ used his powers in October to appoint William Fresell, Prior of Rochester, coadjutor to Ramryge, then very old and infirm.⁵⁶ That this measure might be for the abbey's benefit is evident, but it is not easy to see what good Wolsey did by exempting Tynemouth during the life of its prior, John Stonywell, from the jurisdiction of St. Albans.⁵⁷

Ramryge died early in November 1521, and Wolsey at once set about securing the abbey for himself. The king on hearing his wish⁵⁸ said he would rather give the abbey to him than to any monk, and immediately wrote to ask the pope that Wolsey might hold the monastery *in commendam*.⁵⁹ The appoint-

⁴¹ As well as in the two universities (Harl. MS. 1498, fol. 90 d., &c.).

⁴² Page and Nicholson, *St. Albans Cathedral*, 12, n. 1.

⁴³ *Dict. Nat. Biog.* Fairfax was here apparently in 1502, but afterwards entered the king's service. He was buried in the abbey, where his grave slab still exists.

⁴⁴ *L. and P. Hen. VIII*, i, 1639.

⁴⁵ In the convocation of the province of Canterbury held in 1523 Wolsey, who had then had St. Albans for about eighteen months, was left to decide what proportion of its usual amount of subsidy the monastery should give, as it had previously fallen into debt and could not pay its contribution (*ibid.* iii, 3239). A list of the abbey's creditors and the sums due to them in S. P. Hen. VIII, xxvi, fol. 68-74 d., shows that the house was indebted at Ramryge's death, but unfortunately leaves the extent uncertain. The accounts are not at all clear: they profess to give the sums owed at Michaelmas 1522, but money borrowed on 20 Oct. 1522 is included; and among the old debts, which should mean those contracted under Ramryge, there is one of £50 for the election of the new abbot.

⁴⁶ *L. and P. Hen. VIII*, iii, 510.

⁴⁷ *Ibid.* 487.

⁴⁸ *Ibid.* 510.

⁴⁹ Communicated to him by Pace (*ibid.* 1759) the day after the monks had asked for the *congé d'élire*.

⁵⁰ *Ibid.* 1896.

⁴¹ Early Chan. Proc. bdle. 208, no. 50. Harpesfield is in St. Peter's.

⁴² It had been given to his father and to him (*ibid.* bdle. 216, no. 10).

⁴³ *Ibid.* bdle. 201, no. 30.

⁴⁴ *Ibid.* bdle. 245, no. 28.

⁴⁵ In 1505 the abbot paid £80 of the £100 which he had been fined for the escape of a felon (Lansd. MS. 160, quoted in Page and Nicholson, *St. Albans Cathedral*).

⁴⁶ Star Chamb. Proc. Hen. VIII, bdle. 34, no. 26.

⁴⁷ It seems unlikely that Ramryge would have risked incurring further censures from Morton, who was then chancellor.

⁴⁸ See below, St. Julian's Hospital.

⁴⁹ Harl. MS. 28. The abbot and convent were to celebrate services on 11 Feb. during the king's life, and after his death on the day of his burial, for his soul and the souls of his late consort, his parents and children. On these occasions they were to provide a hearse, cloth for covering, and four waxen tapers each weighing 8 lb., and they were to toll the bells. In return they were to receive 100s. a year from the Abbot and convent of Westminster.

A HISTORY OF HERTFORDSHIRE

ment⁶⁰ was made simply to increase Wolsey's income with an almost cynical disregard for the monastery's rights and welfare. The cardinal's residence as head engaged in the administration of the house was out of the question, an occasional visit was all that could be expected.⁶¹ Naturally the connexion with so powerful a person as Wolsey was not devoid of advantages. Before he held the abbey, it is said, the king's purveyors had been accustomed to have 300 or 400 qrs. of wheat yearly from the town and liberty, an infraction of the charter of Edward IV which Wolsey would not allow.⁶² He intervened also on behalf of the privileges of the house when the clerk of the market of the king's hospice tried to exercise his functions in the town while Henry was staying at the abbey.⁶³ But the benefits received by the monastery, which were apparently all comprised in the cardinal's protection and the plate he presented to the convent,⁶⁴ sink into insignificance before the drawbacks of the position. So little attention was paid by Wolsey to the affairs of the house that in his time the abbey was involved in debts amounting to 4,000 marks through one of its officials, Robert Blakeney.⁶⁵ The utter selfishness of his attitude was strikingly displayed when he fell

⁶⁰ The mandate for restitution of temporalities of 7 Dec. 1521 (*L. and P. Hen. VIII*, iii, 1843) recites that the abbey had been commended to Wolsey by the pope, but as a matter of fact certain formalities had not been completed at the death of Leo X, and the papal bull was not issued until 8 Nov. 1522 (Rymer, *Foed.* [Orig. ed.], xiii, 775). Pope Adrian in May had given Wolsey leave to receive the revenues of St. Albans as if it had been already granted in *commendam* (*L. and P. Hen. VIII*, iii, 2260).

⁶¹ It has been doubted whether he ever stayed there, but he probably did once or twice. The payments of William Seyntpeir on the king's business in 1524 include costs of riding to the More and St. Albans to get money from the cardinal (*L. and P. Hen. VIII*, iv, 167). It seems probable that Wolsey was at St. Albans in 1526, for the accounts of the receiver-general of the abbey from Michaelmas 1525 to Michaelmas 1526 include maintenance of the dean, sub-dean, chaplains, clerks and boys of the cardinal's chapel for seven weeks and four days in August and September (Aug. Off. Misc. Bk. cclxxii, fol. 64). The king seems to have stayed at the abbey at some time (Dugdale, *Mon.* ii, 207), possibly in 1525 (*L. and P. Hen. VIII*, iv, 1736 [12]; Aug. Off. Misc. Bk. cclxxii, fol. 63 d.), and if so the cardinal would certainly have been there.

⁶² Articles on which he was convicted under the Statute of Praemunire (Dugdale, *Mon.* ii, 207).

⁶³ Dugdale, *Mon.* ii, 207.

⁶⁴ It consisted of a basin and ewer, parcel gilt, two standing pots of silver, parcel gilt, two salts with one cover, gilt, and a standing cup with cover, gilt (*L. and P. Hen. VIII*, iv, 6748).

⁶⁵ In a letter of 1535 this is said to have happened in the last abbot's days (ibid. ix, 1155).

into disgrace. In 1529 he granted an annuity of 200 marks out of the abbey's lands to Viscount Rochford, Anne Boleyn's brother,⁶⁶ and if it be argued that in this matter he could not help himself, that excuse cannot be urged for his attempt to get a pension for himself from St. Albans.⁶⁷ He resigned the abbey to the king on 17 February 1530,⁶⁸ but the house was not treated as vacant until his death at the end of the year.⁶⁹

Robert Catton, Prior of Norwich, became abbot in March 1531.⁷⁰ A condition of the appointment to the abbacy seems to have been the cession of La Moor Manor to the Crown,⁷¹ and this was done in September by the abbot,⁷² who received in exchange the property of the priories of Pré and Wallingford which had been suppressed by Wolsey. An annual fair of three days at St. Albans and the advowsons of the church of Aston Rowant and chapel of Stokenchurch, co. Oxon., granted by Henry to the abbey in October 1532,⁷³ may have been intended to make the bargain fairer.

Catton, though ready enough to oblige those in authority, offered some resistance to the attempt made in 1534 to obtain the fee farm of one of the monastery's manors for William Cavendish, Cromwell's servant. Such a grant, he told Cromwell, might cause a claim from the donor's heirs and the loss of the manor to the abbey; if this difficulty were overcome, he would do what Cromwell wanted.⁷⁴ The indenture was drawn up, but Cavendish in the end was balked by the convent, who, in spite of Dr. Lee's persuasions, refused to seal a deed so prejudicial to their house.⁷⁵

The religious changes had some supporters at the abbey: the archdeacon was praised to Cromwell in the spring of 1535 as one of the only two in the liberty to manifest the full truth in their preaching.⁷⁶ But it is not likely that many were as ardent as he in the cause, or the

⁶⁶ *L. and P. Hen. VIII*, iv, 6115.

⁶⁷ Ibid. 6181, 6182, 6224.

⁶⁸ Ibid. 6220.

⁶⁹ 29 Nov. (Cavendish, *Life of Cardinal Wolsey* [Dent's ed.], 243-8). The convent asked for leave to elect on 3 Dec. 1530 (*L. and P. Hen. VIII*, v, 28 [ii]).

⁷⁰ *L. and P. Hen. VIII*, v, 28 (i).

⁷¹ 'Clause declaring the obligation that if A. B. prior of St. Albans be elected abbot of that monastery, within twenty days after he shall suffer . . . all that shall be devised by the king's council for the full assurance of the manors of More and Tyttenhanger to the king's use' (ibid. 78).

⁷² Ibid. 405. The agreement was made in September, in November the abbot ceded the manors, and in December received the property in exchange (ibid. 275; 627 [24]).

⁷³ Ibid. v, 1499 (26-7).

⁷⁴ Ibid. vii, 1125.

⁷⁵ Ibid. 1249.

⁷⁶ Ibid. viii, 407.

RELIGIOUS HOUSES

monastery would have had a better report from John ap Rice, who with others visited it for the king in October.⁷⁷ He merely states that 'they found little at St. Albans, altho' there were much to be found.'⁷⁸ This grudging admission that no scandals had been discovered is good evidence that the convent as to morals was impeccable. Probably little fault could have been found too with the standard of culture there. Six of the community were at Oxford in 1529-30,⁷⁹ and Leland mentions that when he visited the abbey (about 1535) the treasures of the library were displayed to him by a monk of polished learning, much given to the study of all past ages.⁸⁰ The monastery deserves some credit, moreover, for the printing done at St. Albans between 1534 and 1538, for John Hertford had his press in the precincts of the abbey, and published certainly one book at the abbot's request.⁸¹ Where the house was unsatisfactory was on its financial side, and after the visitation and the rules then imposed, as regards the relations of the abbot and monks. Catton told Cromwell on 22 January 1536⁸² that his position was 'so intricate with extreme penury, daily calling of the old debts of the house, daily reparations as well within the monastery as without, and most of all encumbered with an uncourteous flock of brethren,' that it was impossible for him to continue in such a case, and he asked for relaxations of some injunctions. Shortly before or after this letter the prior and seventeen monks wrote to Sir Francis Brian,⁸³ saying that they had begged the abbot to devise a remedy for the decay and misery of the abbey, but he had taken it ill, and they had therefore applied to Brian to bring about the desired reforms through Cromwell, the visitor-general. They asked that the abbot should not be permitted to make Robert Blakeney receiver-general, as he was most unfit for the office; that he might not waste or sell the convent's woods without their consent, and that sales lately made might be stopped; that he should show how much more or less the monastery was in debt than when he became abbot; that the convent might not be forced to use its seal to the detriment of the house, especially for borrowing 'any two thousand pounds or other large sums' until the old debts were cleared off; and finally that those who had

petitioned the abbot might not be punished for it and expelled. On 9 April 1536 Richard Stevenage, the chamberlain, appealed to Brian again for help,⁸⁴ saying that if he did not interfere the abbot would punish them severely; that he himself was to lose his office, for the abbot had forbidden the tenants to pay any more rents to him, and 'though this were grievous to him and contrary to the king's injunctions, he would be ready to suffer if the monastery prospered and were well ordered, which can never be so long as the abbot can do as he will'; finally he suggested that 'a discreet and circumspect brother' should be appointed coadjutor.

Catton may not inspire admiration, he was not a hero,⁸⁵ but he is more deserving of respect than his detractors, some of whom a few months later were informing against the third prior, William Ashwell,⁸⁶ to curry favour with Cromwell.

They reported that Ashwell, talking of Queen Anne when she was in the Tower, said that he trusted 'ere Michaelmas Master Secretary would be in the same case, and that he would jeopard all he was worth to see that day, for he and she were maintainers of all heresies and new-fangledness'; secondly, that while Ashwell and others were in the oriel at dinner Stevenage complained of their fare, which was neither good nor wholesome, contrary to the king's statutes, and Ashwell had said, 'What should we pass upon these statutes which be made by a sort of light-brained merchants and heretics, Cromwell being one of the chief of them,' and when ordered by Stevenage and others to be silent he added, 'Why should we pass upon them that purpose to destroy our religion, let us pass upon the old customs and usages of our house'; thirdly, that at the shaving-house door he had questioned a young man named Newman who wanted to leave the monastery, asking him by what authority he would depart; Newman said, by the king's authority, since all under twenty-two years of age were to remain no longer in religion, and he was kept there against the king's commandment and his own will; to this Ashwell rejoined, 'I marvel that you pass upon that commandment which was not heard of this thousand year before the king hath done it of his high power, contrary to the law of God and man both, for there is no man can say against him'; fourthly, that at supper in the prior's chamber one night the conversation turning on the suppression of the religious houses, Ashwell had said that if the king reigned

⁷⁷ It was probably during the visitation that the abbot on 15 Oct. absolved from obedience to the rule and dismissed William Green or Amphibal and John Campton at their own request (Wills, Archd. of St. Albans, Wallingford Reg. 1, fol. 234 d.).

⁷⁸ *L. and P. Hen. VIII*, ix, 661.

⁷⁹ Aug. Off. Misc. Bk. cclxxiv.

⁸⁰ *De Scriptoribus Britannicis* (ed. 1709), 316-17.

⁸¹ Dugdale, *Mon.* ii, 207; *V.C.H. Herts.* ii, 56.

⁸² *L. and P. Hen. VIII*, x, 152.

⁸³ *Ibid.* ix, 1155.

⁸⁴ *L. and P. Hen. VIII*, x, 642.

⁸⁵ On an outbreak of the plague at St. Albans in Oct. 1534 he had retired to Tyttenhanger (*ibid.* vii, 1324).

⁸⁶ Exch. T. R. Misc. Bk. cxx, fol. 78.

A HISTORY OF HERTFORDSHIRE

seven years longer he meant to leave only four churches in England; lastly, that he had disclosed secrets of the confessional.

Of the nine witnesses examined 24–8 August 1536,⁸⁷ one only, Thomas Newman, swore to the whole truth of the first four articles, another swore to two and one to the fourth; two had heard Ashwell say something like the first; Stevenage denied the first and third articles, could not vouch for time and place as regards the fourth, and gave the following account of the incident mentioned in the second: some of those dining in the frater came into the oriel during refection, and said they would like some of that meat because theirs was not good; Stevenage remarked that by one of the king's injunctions, which he thought ought to be kept, they should all dine together and have the same food; Ashwell then said, 'As for the king's injunctions I pray you who made them but a sort of light persons and heretics? Let us keep well our old statutes as others have done before us'; to which Stevenage replied, 'I think the statutes were made by the king's council, therefore I pray let us talk of other matters.' Ashwell, as to the second, affirmed that all he had said was that 'neither the king nor his council will break any laudable customs of our monastery or do anything to the hindrance of good religion'; he denied the first, third and fourth, but had heard several say that only four religious houses should be left; and he declared the allegation about the confession to be false.

The affair looks rather like a continuation of the intrigue against the abbot, the move this time being to discredit and cow his party. Catton was undoubtedly well disposed to Ashwell,⁸⁸ whose adversaries were the same as his. Eight out of the nine witnesses called against Ashwell were the abbot's opponents, and the one exception, Guynett, gave evidence most damaging to the informers.

The appointment by Cromwell of Stevenage as prior in the autumn of 1537⁸⁹ boded no good to Catton. On 10 December Lee and Petre made a visitation of the monastery, and reported⁹⁰ that the abbot, from the examination of the monks and his own confession, could be justly deprived for breaking the king's injunctions and for dilapidations and negligent administration, but he refused to entertain the idea of sur-

⁸⁷ Exch. T. R. Misc. Bk. cxx, fol. 79–82.

⁸⁸ In sending the accused man to Cromwell he said that he had hitherto regarded him as an honest man (*L. and P. Hen. VIII*, xi, 251).

⁸⁹ Chr. Hales to Cromwell 10 Oct. 1537: 'The prior of St. Alban's lately made by your lordship desires that he may receive the money of the house as other priors have done' (ibid. xii [2], 873).

⁹⁰ Cott. MS. Cleop. E iv, fol. 43, printed in Dugdale, *Mon.* ii, 249.

rendering the house,⁹¹ declaring that he would rather beg his bread all the days of his life. They asked Cromwell whether they had better remove him at once, when the house being in such debt none would take it except for the purpose of surrender, or whether they should delay sentence and leave him in suspense until he should give the abbey into the king's hands in order to assure himself a living. The former course was adopted. Catton was deposed, and the convent compromised the election to Cromwell,⁹² who in April 1538 made Stevenage abbot.⁹³

The ex-abbot is mentioned again in connexion with his supplanter, for Stevenage in September declined to seal an indenture providing for Catton, on the ground that it differed from the agreement made between them before Cromwell, and insinuated that Catton was trying to get an advantage over him.⁹⁴

The visitors had not underrated the pecuniary embarrassments of the house. The new abbot was actually detained a prisoner by Gostwyke, the collector of the king's tenths, and wrote to Cromwell that he had offered to pay £300, the utmost he could raise, but was utterly unable to meet Gostwyke's demand for first-fruits.⁹⁵ The weight of debt was becoming unbearable.

An incident which occurred in October 1539 seems also significant, though in another way. Stevenage, in obedience to Cromwell's letters, then sent to him 'John Pryntare,' in company with three stationers of London, 'to order him at your pleasure,' and promised that he would search for copies of the little book of detestable heresies that the stationers had showed him.⁹⁶ The end was not far off when heretical books were being printed at St. Albans, probably within the monastic inclosure.⁹⁷ The abbey was, in fact, surrendered on 5 December.⁹⁸ Stevenage, or Boreman, as he is henceforth called, was given a pension of £266 13s. 4d. a year, and all the monks also received annuities.⁹⁹

⁹¹ The surrender was expected at this time. See John Husee to Lord Lisle (*L. and P. Hen. VIII*, xii [2], 1209).

⁹² *L. and P. Hen. VIII*, xiii (1), 181.

⁹³ Ibid. 887.

⁹⁴ Ibid. (2), 385.

⁹⁵ Ibid. (1), 182. The farmer of Hexton parsonage applied to the abbot in vain for £4 due for repairs (Ct. of Requests, bdle. 2, no. 52).

⁹⁶ *L. and P. Hen. VIII*, xiv, 315.

⁹⁷ John Printer certainly suggests the John Hertford mentioned above as having a printing-press within the abbey.

⁹⁸ Dugdale, *Mon.* ii, 249–50.

⁹⁹ *L. and P. Hen. VIII*, xv, 547. Sums varying from £5 to £13 6s. 8d. were still paid to twenty-four monks in Queen Mary's reign (Clutterbuck, *Hist. and Antiq. of Herts.* i, App. ii).

RELIGIOUS HOUSES

The convent at this time numbered thirty-eight, including the prior. Like others, it had decreased in the course of years. At the end of the 12th century John de Cella had fixed the maximum number of brothers at 100, unless there was special reason to receive anyone further.¹⁰⁰ Whether this number was ever attained before the Black Death is doubtful; it certainly was not reached afterwards. In 1380 the community at St. Albans, not counting the abbot and prior, comprised 52 professed, 2 novices and 2 lay brothers¹; there were 51 brothers besides the prior at the abbey in 1396,² 54 in 1401,³ 46 in 1451,⁴ 48 or 49 in 1476,⁵ at least 54 in 1492,⁶ and 48 with 6 others at Oxford in 1529-30.⁷

Boreman, who bought the site of the abbey from Sir Richard Lee in November 1551⁸ for the grammar school he had been authorized to establish,⁹ made it over in December 1556 to Queen Mary, no doubt for the refoundation of the monastery,¹⁰ but nothing further is heard of the project.

The income of the abbey was reckoned in the Valor of 1535 as £2,102 7s. 1½d. clear.¹¹ Of its extensive possessions the largest amount lay in the county of Hertford, where in 1303 and 1401 the abbot held six knights' fees in the hundred of Cashio.¹² From the episode of the fight at St. Albans in 1142, when King Stephen captured William de Mandeville, it appears that the holders of land by military tenure under the abbey at that time had quarters within the precincts to defend it when necessary.¹³ The knights of St. Alban, it is related, offered valiant resistance to the king until he made satisfaction to the church for its violation by his followers. One of the knights sent by Abbot Roger in 1277 to Worcester for the war against the Welsh was Sir Stephen de Chenduit,¹⁴ while John de Gorham, William Tolomer and Richard Baccheworthe are mentioned among the six knights who went

to Carlisle in 1299-1300 to do service for Abbot John de Berkhamstead.¹⁵

The convent, as has been already mentioned, had their own possessions apart from the abbot. The separation of property seems to have been a gradual process. Before the Conquest one or two estates¹⁶ had already been allotted for special purposes, but these were probably exceptions. In the early part of the 12th century the abbot and convent seem to have received their maintenance from the same property, the revenues being divided between them in a fixed proportion.¹⁷ Shortly afterwards, however, the various offices of the obedientiaries began to be endowed with separate estates. Thus Abbot Geoffrey gave to the office of kitchener the manor of 'Esole'¹⁸ (St. Albans Court in Nonington, Kent) and Abbot Ralph Gubien the manor of Shephall¹⁹ (Herts.). The offices of sacrist,²⁰ hostillar, chamberlain, refectorer, infirmarer and almoner²¹ each received its own estate, which was augmented from time to time. An important readjustment of property was made in 1363 by Abbot Thomas de la Mare.²² The kitchener's office was then especially needy,²³ for its income was £181 and its expenses £255 8s. 8d. The abbot reduced its charges about £51 a year by relieving it of the pensions payable to four scholars at Oxford and four monks at Redbourn, and of the maintenance of seven monks at the abbey; while he increased its permanent revenues about the same amount by an allotment of lands. He effected, too,

¹⁵ *Reg. of St. Albans*, ii, App. D, 329.

¹⁶ Childwick for the food of the younger monks (*Gesta Abbat.* i, 54), Westwick for the monks' table (*ibid.* 64), Redbourn for their clothing (*ibid.* 52).

¹⁷ *Ibid.* 74. There were fifty-three 'ferms' of 46s. Of these fifty-two were divided between the cellarers of the monks and 'curia,' the first receiving 33s. and the other 13s. Out of the monks' portion 3s. a week went to carriers who brought the food from London and elsewhere.

¹⁸ *Gesta Abbat.* i, 74.

¹⁹ *Ibid.* 107.

²⁰ For the property of this office see Cott. MS. Jul. D iii.

²¹ Lansd. MS. 375 gives an account of the almoner's property.

²² Cott. MS. Claud. E iv, fol. 250 d.-2 d. The mutual payments of abbot and convent here recorded are very interesting. Among others are the following: the kitchener received from the abbot rent from his manors called 'kitchener's ferm,' amounting to £75 13s., toll-corn from Sopwell mill, from the abbot's kitchen a dish daily, from his cellarer daily 4 gallons of ale, money in lieu of fowls and eggs, altogether a sum of £96 a year; the abbot received from the kitchener an allowance of food priced at £13 16s. 8d. a year, pittances worth £52 annually, 20 marks from Wingrave Church, and a mark for a Christmas present. The infirmarer paid the abbot yearly £12 16s. 8d., of which £10 was for wine.

²³ Thomas had had personal experience of the difficulties of this office (*Gesta Abbat.* ii, 374-5).

¹⁰⁰ *Gesta Abbat.* i, 234.

¹ Cott. MS. Nero, D vii, fol. 81 d.-3 d.

² *Gesta Abbat.* iii, 425-6. Priors of cells are excluded.

³ *Ibid.* 480-1.

⁴ *Reg. of St. Albans*, i, 11-13.

⁵ *Ibid.* ii, 145-6.

⁶ Add. Chart. 33687.

⁷ Aug. Off. Misc. Bk. cclxxiv.

⁸ Palgrave, *Anct. Cal. and Invent.* (Rec. Com.), ii, 420.

⁹ *V.C.H. Herts.* ii, 56-8.

¹⁰ Close, 3 & 4 Phil. and Mary, pt. ii, m. 13. The property was to be devoted to such pious uses as Cardinal Pole should advise for the salvation of Boreman's soul.

¹¹ *Valor Eccl.* (Rec. Com.), i, 451. The sum total only remains.

¹² *Feud. Aids*, ii, 425-7, 444.

¹³ Matt. Paris, *Hist. Angl.* (Rolls Ser.), i, 270-1.

¹⁴ *Gesta Abbat.* i, 435.

A HISTORY OF HERTFORDSHIRE

various rearrangements of the possessions of other obedientiaries.

In 1529-30²⁴ all the offices²⁵ were sequestered, and the monks were receiving stipends: the prior £40, the sub-prior £11, 47 brothers sums ranging from £8 13s. 4d. to £6 13s. 4d., the total amounting to £416 13s. 4d. Six students at Oxford had each £10. The expenses for illness²⁶ were £30 17s. 11d. Fees and wages, such as to the chief steward, solicitor, the abbot's secretary, the organist²⁷ of the church and others cost £74 13s. 6d. The household servants received £43 16s. They numbered thirty-five, and included a clerk of the kitchen and three engaged in the work of the kitchen, two butlers, three poor men to assist the brothers celebrating mass, an attendant for the sick, another for one particular invalid, the prior's carver, butler and the keeper of his horses, two brewers, people making the monks' clothes, and washing the linen of the convent and church, the keeper of the church clock and bells, and of the convent's firewood in the oriel. Liveries due to officers and servants were reckoned separately and cost £75 10s. 4d. Alms on anniversaries and for the soul of King Offa came to £2; diet of 12 poor men praying daily for King Offa's soul, £17 12s. 8½d.; payments to the king and pope, £48 1s.; annuities, £138 19s. 4d.; cutting and carting wood for the convent's use, £45 13s. 0½d.; mowing and making hay, £7 8s. 10d.; shoeing the convent's horses, £14 0s. 8d.; purchases of wax, oil and wine, £19 18s. 7d.; repairs, £105 2s. 3d. Under necessaries, which cost £55 15s. 1½d., are included charcoal for the dormitory, expenses of the justices in time of session, cleansing the stream and ditch, mending the organs, mole-catching, cords for the bells, mowing nettles round the monastery, &c., the largest outlay being £9 7s. 2d. for candles. The money spent that year amounted altogether to £1,203 0s. 5½d. The house must have been rich in treasures.²⁸

²⁴ Aug. Off. Misc. Bk. cclxxiv. The folios are not numbered.

²⁵ They numbered nine in 1525-6: the offices of the kitchener, chamberlain, refectorer, sacristan, almoner, infirmarer, and those of spices and of the ordinances of Abbots Wheathampstead and Ramryge (ibid. cclxxii).

²⁶ Sixteen monks exclusive of novices had been ill.

²⁷ Henry Bestney, who received 2 marks a year and his board.

²⁸ In the time of Henry IV it had 11 rings, 2 containing balas rubies, 7, sapphires, one, a topaz, and one, a peridot; 8 other precious stones, probably unset; 2 gold chalices, 24 others of silver or silver gilt; 26 phials of beryl or silver, 9 mitres, some of precious work, 2 'paxbreds,' 2 pastoral staves, 8 pectorals, and 5 censers of silver-gilt, &c. (Amundesham, *Annales*, ii, App. I). Large additions were made to its plate and ornaments under Wheathampstead.

At the Dissolution the gold of its brooches and rings weighed 122½ oz.; of silver-gilt plate it had 2,990 oz., of parcel gilt 680 oz. and of white plate 354 oz.²⁹

ABBOTS OF ST. ALBANS

Willigod,³⁰ 793, died 796

Eadric, 796

Wulsig, 9th century

Wulnoth, probably early 10th century

Eadfrith, 10th century

Wulsin, mid-10th century

Ælfric, c. 968, made Bishop of Ramsbury 990, Archbishop of Canterbury 995

Leofric, 990, died c. 1007

Ealdred, c. 1007

Eadmar, living 1045

Leofstan, surnamed 'Plumstan,' c. 1048, died 1066

Stigand, 1066

Frederic, appointed c. 1066,³¹ occurs 1072,³² fled to Ely c. 1077³³

Paul, appointed 28 June 1077,³⁴ died 11 November 1093³⁵

Richard de Albini, appointed 1097,³⁶ died 16 May 1119³⁷

Geoffrey de Gorham, elected 1119,³⁸ died 25 February 1146³⁹

Ralph Gubiun, elected 8 May 1146,⁴⁰ died 5 July 1151⁴¹

Robert de Gorham, received benediction 18 June 1151,⁴² died 23 October 1166⁴³

Simon, received benediction 20 May 1167,⁴⁴ died 1183⁴⁵

Warin, received benediction 8 September⁴⁶ 1183,⁴⁷ died 29 April 1195⁴⁸

²⁹ *Monastic Treasures* (Abbotsford Club), 29.

³⁰ For authorities for the sequence and dates of the first twelve names see above, pp. 368-72.

³¹ *Gesta Abbat.* i, 44.

³² William of Malmesbury, *De Gestis Regum Angl.* (Rolls Ser.), ii, 349-52.

³³ He is said in the *Gesta Abbat.* (i, 44) to have ruled for twelve years, but this seems a miscalculation.

³⁴ *Ibid.* 50.

³⁵ *Ibid.* 64.

³⁶ *Ibid.* 66.

³⁷ *Ibid.* 72.

³⁸ *Ibid.* 73. He was prior (Matt. Paris, *Chron. Maj.* ii, 148).

³⁹ *Gesta Abbat.* i, 95.

⁴⁰ Matt. Paris, *Hist. Angl.* i, 276.

⁴¹ *Gesta Abbat.* i, 110.

⁴² Matt. Paris, *Chron. Maj.* ii, 187.

⁴³ *Gesta Abbat.* i, 182.

⁴⁴ *Ibid.* 183. The royal licence to elect had been delayed for some months.

⁴⁵ Matt. Paris, *Chron. Maj.* ii, 318. The year given in the *Gesta Abbat.* (i, 194) is 1188, but this is obviously a slip. One of Warin's acts is dated 1186 (*Gesta Abbat.* i, 205).

⁴⁶ *Gesta Abbat.* i, 195.

⁴⁷ See n. 45.

⁴⁸ *Gesta Abbat.* i, 217.

RELIGIOUS HOUSES

John de Cella, elected 20 July 1195,⁴⁹ died 17 July 1214⁵⁰
 William de Trumpington, elected 20 November 1214,⁵¹ died 24 February 1235⁵²
 John de Hertford, elected March 1235,⁵³ died 19 April 1263⁵⁴
 Roger de Norton, received papal confirmation 9 September 1263,⁵⁵ died 3 November 1290⁵⁶
 John de Berkhamstead, elected 9 December 1290,⁵⁷ confirmed by the pope 13 March 1291,⁵⁸ died October 1301⁵⁹
 John de Maryns, elected 2 January 1302,⁶⁰ died 23 or 24 February 1308-9⁶¹
 Hugh de Eversden, elected 1309,⁶² received papal confirmation 11 February 1310,⁶³ died 7 September 1327⁶⁴
 Richard de Wallingford, appointed by papal provision 1 February 1328,⁶⁵ died 23 May⁶⁶ 1336⁶⁷
 Michael de Mentmore, elected 1 June 1336,⁶⁸ confirmed 18 November 1336,⁶⁹ died 1349⁷⁰
 Thomas de la Mare, elected 1349,⁷¹ died 15 September 1396⁷²
 John de la Moote, elected 9 October 1396,⁷³ died 11 November 1401⁷⁴

William Heyworth, elected 12 December 1401,⁷⁵ consecrated Bishop of Lichfield in 1420⁷⁶
 John Bostock or Wheathampstead, S.T.D., elected in 1420,⁷⁷ resigned 26 November 1440⁷⁸
 John Stoke, S.T.B., elected January 1441,⁷⁹ died 14 December 1451⁸⁰
 John Wheathampstead, re-elected 16 January 1452,⁸¹ died 20 January 1465⁸²
 William Albone, elected 25 February 1465,⁸³ died 1 July 1476⁸⁴
 William Wallingford, elected 5 August 1476,⁸⁵ died June 1492⁸⁶
 Thomas Ramryge, elected 1492,⁸⁷ died 1521⁸⁸
 Thomas Wolsey, received the abbey *in commendam* 7 December 1521,⁸⁹ died 29 November 1530⁹⁰
 Robert Catton, elected in March 1531,⁹¹ deprived January 1538⁹²
 Richard Boreman or Stevenage, S.T.B., elected 1538,⁹³ surrendered the abbey 5 December 1539⁹⁴

A pointed oval seal of the 12th century⁹⁵ represents St. Alban seated on a carved throne, with his feet on a small footstool; he holds

⁴⁹ Matt. Paris, *Chron. Maj.* ii, 411.

⁵⁰ *Ibid.* 576.

⁵¹ *Gesta Abbat.* i, 253. He was blessed 30 November (*ibid.*).
⁵² *Ibid.* 300.

⁵³ The *congé d'élire* was given 28 Feb. (*Cal. Pat.* 1232-47, p. 95), the king's letter to the pope announcing the election 1 Apr. (*ibid.* p. 98).

⁵⁴ In the *Gesta Abbat.* (i, 396) the year is given as 1260, but that it was 1263 is shown by *Cal. Pat.* 1258-66, p. 256.

⁵⁵ *Cal. Papal Letters*, i, 393. The king's order for the restoration of temporalities is dated 21 Dec. 1263 (*Cal. Pat.* 1258-66, p. 304).

⁵⁶ *Gesta Abbat.* i, 485. ⁸⁷ *Ibid.* ii, 7.

⁵⁸ *Cal. Papal Letters*, i, 531-2.

⁵⁹ *Gesta Abbat.* ii, 50. Here he is said to have died 19 Oct., but the abbey appears to have been vacant on the 14th (*Cal. Close*, 1296-1302, p. 470).

⁶⁰ *Gesta Abbat.* ii, 53. Mandate to restore temporalities is dated 12 Aug. (*Cal. Pat.* 1301-7, p. 53).

⁶¹ *Gesta Abbat.* ii, 108.

⁶² Before 27 Apr. (*Cal. Pat.* 1307-13, p. 112).

⁶³ *Cal. Papal Letters*, ii, 66.

⁶⁴ *Gesta Abbat.* ii, 178.

⁶⁵ *Cal. Papal Letters*, ii, 269. The election of 29 Oct. 1327 (*Gesta Abbat.* ii, 183) had not been in form.

⁶⁶ *Gesta Abbat.* ii, 293.

⁶⁷ *Cal. Close*, 1333-7, p. 583.

⁶⁸ *Gesta Abbat.* ii, 300.

⁶⁹ *Cal. Papal Letters*, ii, 531.

⁷⁰ Shortly before 18 Apr. (*Cal. Pat.* 1348-50, p. 277).

⁷¹ Order for the restitution of temporalities, 22 Nov. (*ibid.* p. 430).

⁷² *Gesta Abbat.* iii, 422.

⁷³ *Ibid.* 425-31.

⁷⁴ *Ibid.* 479.

⁷⁵ *Gesta Abbat.* iii, 487-8.

⁷⁶ He was given the see by the pope 20 Nov. 1419 (*Cal. Papal Letters*, vii, 134), and must have vacated the abbacy about July 1420, since leave to elect his successor was given on 5 Aug. (*Cal. Pat.* 1416-22, p. 312).

⁷⁷ Order for the restitution of temporalities, 23 Oct. (Pat. 8 Hen. V, m. 12).

⁷⁸ Amundesham, *Annales*, ii, 240.

⁷⁹ The king assented to the election 15 Jan. (*Cal. Pat.* 1436-41, p. 527).

⁸⁰ *Reg. of St. Albans*, i, 5.

⁸¹ *Ibid.* 10-18.

⁸² *Ibid.* ii, 25.

⁸³ *Ibid.* 29-35

⁸⁴ *Ibid.* 140.

⁸⁵ *Ibid.* 141-58.

⁸⁶ The abbey was vacant 20 June (Add. Chart. 34350). The king's leave to elect was given 29 June (Pat. 7 Hen. VII, m. 3).

⁸⁷ The king assented to the election 16 Sept. (*ibid.* 8 Hen. VII, pt. i).

⁸⁸ The monks asked the king's leave to elect 12 Nov. 1521 (*L. and P. Hen. VIII*, iii, 1759).

⁸⁹ The king's order for the restitution of temporalities is dated 7 Dec. (Rymer, *Foed.* [Orig. ed.], xiii, 760).

⁹⁰ Cavendish, *Life of Wolsey*, 243-8.

⁹¹ The convent asked for the king's assent to the election on 14 Mar. (*L. and P. Hen. VIII*, v, 166 [28]).

⁹² The king's leave to elect to the vacant abbacy was granted 15 Jan. (*ibid.* xiii [1], 190 [13]).

⁹³ The royal order for the restitution of temporalities was made 10 Apr. (Pat. 29 Hen. VIII, pt. iv, m. 14).

⁹⁴ Dugdale, *Mon.* ii, 249-50.

⁹⁵ B.M. Seals, lxiv, 58.

A HISTORY OF HERTFORDSHIRE

a long cross in his right hand and in his left a globe and a palm-branch. Legend :

SIGILLUM : SĀI ALBANI : ANGLORV̄ : ꝢTOMARTIRIS

The seal of Abbot Simon⁹⁶ (1167-83), also a pointed oval, shows the abbot arrayed in vestments and mitre, standing on a platform, with a crozier in his right hand and in his left a book.

The seal of Abbot John de Hertford is attached to a charter of 1258.⁹⁷ On the obverse, a pointed oval, is depicted the abbot, mitre on head, raising his right hand in benediction and holding in his left, from which hangs a maniple, a pastoral staff. All that remains of the legend is the letters

. ALBAN

The counterseal, a smaller pointed oval, shows the martyrdom of St. Alban and the headsman's eyes falling into his left hand ; above a hand issuing from clouds holds a crown above the saint's head. Legend :

MARTIR OBIT VICTOR PRIVATVR LVMINE LICTOR

The seal of Abbot Thomas de la Mare appended to a document of 1389⁹⁸ is of pointed oval shape. The abbot, who wears a mitre and embroidered vestments, stands in a carved niche under a triple canopy ; he has in his right hand his crozier and holds in the other a richly ornamented book. In a small canopied niche above is a representation of the martyrdom of St. Thomas of Canterbury. On tabernacle work at each side and between two flowering branches is an elaborately cusped panel containing on the left St. Alban's head with a sword across the neck, on the right a bust, probably of St. Amphibalus ; the field is powdered with roundels. The corbel is adorned with a carved string-course and foliage. Legend :

. OME : DEI : GRA : ABBATIS : MONASTERII :
SĀI : ALBANI

A seal of the early 16th century,⁹⁹ probably belonging to Abbot Thomas Ramryge, shows our Lord enthroned and blessing, between two small canopied niches, that on the left containing a saint, the other a king wearing a crown and ermine tippet and holding a sceptre and orb. The legend is missing.

There is a fine but imperfect seal ad causas of the 14th century in style, but attached to a charter of 1510.¹⁰⁰ It depicts in a carved and canopied niche the martyrdom of St. Alban with the miracle of the executioner's eyes. In

⁹⁶ B.M. Seals, lxiv, 59.

⁹⁷ B.M. Chart. L. F. C. vii, 6.

⁹⁸ Add. Chart. 19911.

⁹⁹ Ibid. 18184.

¹⁰⁰ Ibid. 21377.

the base, upon masonry, is a shield of the arms of the abbey. Legend :

M[ARTIR : OB]IT : VICTOR : PRIVATVR : LUM[INE :
LICTOR]

2. REDBOURN PRIORY

The cell of St. Amphibalus at Redbourn was established as the result of the miraculous discovery of the remains of St. Amphibalus and his fellow-martyrs in 1178.¹ St. Alban appeared at night to an inhabitant of St. Albans called Robert, and told him that he wished to make known the burial-place of Amphibalus, who had converted him to Christianity. Robert rose, was led by the saint to Redbourn, and shown the spot where Amphibalus and his companions lay. After marking the place for future identification, Robert returned with St. Alban, who disappeared when they arrived at his church. The story was spread abroad, and in the end reached Abbot Simon, who sent some monks with Robert, and set a guard over the ground, the holiness of which was attested by miracles of healing. Exploration there was rewarded by the discovery of several bodies, one of which was identified as that of St. Amphibalus from the received account of the manner of his death. The remains were removed to the abbey, and on their way were met by a procession of monks with the shrine of St. Alban, who showed his joy by wonderful signs.

The foundation by the Abbot of St. Albans of the cell on the portion of Redbourn Heath which included the grave of St. Amphibalus and the chapel of St. James² is left unnoticed, possibly because it was regarded as part of the events just recorded,³ but the house existed in the time of Simon's successor, Warin (1183-95), who used it as a health resort for the convent of St. Albans.⁴ The priory and monks were plundered unmercifully by the soldiers of Louis of France on 1 May 1217.⁵ One of the treasures, however, a silver-gilt cross containing a piece of the holy cross, was soon recovered. The man who, unknown to his fellows, had stolen it was seized with a fit after leaving the priory, and became so violent that his comrades had to bind his hands and take him thus to Flamstead Church, which they meant to raid. At the entrance the cross fell from his bosom, and was

¹ Matt. Paris, *Chron. Maj.* (Rolls Ser.), ii, 301-8. The remains, there is little doubt, were those of a pagan Anglo-Saxon burial. See *V.C.H. Herts.* i, 256-8.

² *Gesta Abbat.* (Rolls Ser.), ii, 400.

³ An agreement of 1383 concerning the heath says the priory was built immediately after the translation of St. Amphibalus (*ibid.* iii, 260).

⁴ *Ibid.* i, 211.

⁵ Matt. Paris, *Chron. Maj.* iii, 16-17.



ST. ALBANS ABBEY.
(12th century).



SIMON, ABBOT OF ST. ALBANS
(1167-83).



JOHN DE HERTFORD, ABBOT OF ST. ALBANS
Counterseal
(1235-63).



SALBURN PRIORY IN STANDON
(13th century).



HERTFORD PRIORY
(13th century).



CHESHUNT PRIORY
(12th century).

RELIGIOUS HOUSES

picked up by the parish priest, who inquired what it was. The robbers, recognizing that their companion's seizure was a punishment for sacrilege, were terrified and begged the priest to take the cross back at once to the monks. It was possibly to compensate for losses then sustained that Abbot William de Trumpington (1214-35) gave to the house a beautiful psalter and ordinal and two gilded shrines.⁶ For the safety of the shrines and the relics in them he appointed a monk with a colleague to relieve him to guard them continually. During the time of this abbot the conventual church was consecrated by John Bishop of Ardfert.⁷

The regulations made by Abbot Roger in 1275 with regard to monks who died at Redbourn⁸ show that there was no cemetery here. The cell was, as in Abbot Warin's day, a place where the monks could have a brief relief from strict discipline.

The constitutions of Abbot Richard de Wallingford (1326-35) for Redbourn⁹ aimed chiefly at preventing too great relaxation of the rule. The three monks taking their turn there were to remain a month, and were neither to go nor return on foot; a brother at Redbourn who by permission came to St. Albans must be accompanied by his prior; the brothers were to go to matins, say together the canonical hours, and hear the mass of the day, and those who were priests must not omit for four days to celebrate mass; constant transgressors of these rules were to have their stay shortened; they were to take the air together in places removed from public concourse and return in good time for dinner; they were forbidden to visit neighbouring houses and friends or go beyond the boundaries without the prior's leave, and to go on foot a mile beyond the priory, or stay the night anywhere without the abbot's permission; they must not eat before the common meal or sup in time of regular fast without leave of the prior, who was to be very careful how he gave it; their food was to be served daily from the kitchen of the abbey as for monks at St. Albans; the prior and brothers were not to keep hunting-dogs, hunt, look on at the sport, or leap over the hedges of their neighbours; they must not bring into the house persons of doubtful reputation to eat or talk with them, or have intercourse with such outside.

The arrangement about food did not work at all well: hot dishes sent from the abbey

⁶ *Gesta Abbat.* i, 282, 294. The shrines were those made to receive the remains of St. Amphibalus and his companions.

⁷ *Ibid.* 289. An indulgence of forty days was granted on this occasion.

⁸ *Ibid.* 452. By tradition the bodies of the monks dying at Redbourn were brought to St. Albans by the River Ver.

⁹ *Ibid.* ii, 202-5.

were naturally not very palatable when they reached Redbourn, about 3 miles off, and when sold at St. Albans fetched little; so that the monks at Redbourn were reduced to all kinds of shifts for their maintenance.¹⁰ This state of things was ended by Abbot Thomas de la Mare¹¹ (1349-96), and the sum of 5s. a week was given in lieu of food.¹² He also simplified the matter of the convent's supply of fuel, ordaining that they should have sixteen cartloads of wood at Michaelmas instead of the two logs a day from 1 November to 2 February allowed them by his predecessor, Michael de Mentmore.¹³ Abbot Thomas did much for the priory, giving vestments, plate, furniture and books,¹⁴ rebuilding the chapel of St. James,¹⁵ which had been burned down many years before,¹⁶ and among other improvements to the buildings¹⁷ constructing a house¹⁸ which he could use both as a wardrobe and study when he visited Redbourn. He was very fond of the place and frequently stayed there, though he was careful that his presence should not cause constraint or be burdensome in any way to the convent.¹⁹

It was no doubt through his endeavours that Thomas de Beauchamp Earl of Warwick in 1383 renounced his claim to Redbourn Heath.²⁰ The dispute on the point had for years²¹ caused the priory great inconvenience, for the Flamstead men, relying on their lord's support, had kept up a continual feud with the convent; on one occasion they had seized the cart with the monks' provisions and taken it to Flamstead, and the prior had been so frightened lest his food supply might be cut off that he had bought another less public approach to the priory.²²

The stone walls round the outer court were repaired by Abbot John Wheathampstead (1420-40), who also gave £7 to the fabric of the kitchen²³ and contributed to decorate the chapel

¹⁰ *Gesta Abbat.* ii, 397-8.

¹¹ *Ibid.*

¹² This seems the inference from *ibid.* 400. Bread and ale probably continued to be supplied from the abbey (Amundesham, *Annales* [Rolls Ser.], ii, 206).

¹³ *Gesta Abbat.* ii, 398.

¹⁴ His gifts included spoons, tables, napkins, hangings for the hall, graduals, a complete volume of Legends of the Saints commemorated throughout the year, red silk curtains for the altar and a frontal to match and precious frontals and drapery for the altar in Lent (*ibid.* 399).

¹⁵ Brother John de Bokedene and William Stubard, a lay brother, carried out this work (*ibid.*).

¹⁶ *Ibid.* 400.

¹⁷ He spent 100 marks here in building and payment of debts (*ibid.* 391).

¹⁸ *Ibid.* 399.

¹⁹ *Ibid.* 400.

²⁰ *Ibid.* iii, 259-60.

²¹ It had gone on in the time of the previous earl, who died in 1369.

²² *Gesta Abbat.* iii, 258.

²³ Amundesham, *Annales*, ii, 264, App. A.

A HISTORY OF HERTFORDSHIRE

and improve the altar.²⁴ From the regulations, however, which he would have introduced in 1439,²⁵ internal amendment seems to have been what the house most needed. Sometimes there were only two monks there, sometimes the place was left empty. Wheathampstead ordered that with the prior they must number at least four, and they were to remain their appointed time without interruption unless recalled by their superior; they were to go to the chapel every day and say together the canonical service; at festivals mass and vespers were to be sung,²⁶ and to help in the singing two clerks²⁷ were to be added to the house, due provision being made for the expense of the increased convent²⁸; St. Amphibalus was to be commemorated at Redbourn as at the abbey; the brothers were each to celebrate mass daily, and that they might be the readier for their duty they were to go to bed earlier²⁹ and abstain from late potations, superfluous repasts, from roaming about and excessive recreation; they were to avoid doubtful places while on their way to the priory and were to bring nobody into the house from whom scandal might easily arise. The abbot, moreover, exhorted them to employ their leisure time there in reading, learning, or other useful employment to prevent idleness. These rules in essentials differed very little from Richard de Wallingford's, yet they were so strongly opposed by a section of the convent at St. Albans as encroachments on their liberty and novelties that the abbot had to let the matter drop.³⁰

Beyond the mention of the prior in 1492³¹ nothing more is heard of the house until 1535, when apparently it was already abandoned.³²

²⁴ Amundesham, *Annales*, ii, 200. It was perhaps the parochial, not the conventual, church, over the nave of which a chamber was built at this time.

²⁵ *Ibid.* 203-11.

²⁶ Abbot Thomas had had mass sung there on Sundays and the principal feasts (*Gesta Abbat.* ii, 401).

²⁷ They were besides to serve the monks at table and do anything they were asked in reason (Amundesham, *op. cit.* ii, 206).

²⁸ The sum of 9*s.* a week for food was allowed, besides extra bread and ale from the refectory, the money and the clerks' stipends being paid by the master of the works out of the issues of the manors of Radwell and Burston and messuages in Sleaf and Sandridge assigned to him for that purpose (*ibid.*).

²⁹ The abbot in 1423 had ordered them not to sit up too late, since from this cause they omitted to keep the vigils they were bound to observe (*ibid.* i, 113).

³⁰ *Ibid.* ii, 211-12. ³¹ *Add. Chart.* 34350.

³² It is described as a cell annexed to St. Albans (*Valor Eccl.* [Rec. Com.], i, 451). The king's commissioners in 1537 returned it as uninhabited by religious persons (Transcript of Land Rev. Rec. bde. 66, no. 3. This document, owing to rearrangement of the class to which it belongs, cannot now be traced).

The priory received small gifts from time to time from secular persons,³³ but as far as can be seen practically all its resources were derived directly or indirectly from the abbey. The tithes of Winslow, co. Bucks., of old belonging to the almoner, were assigned by Abbot Thomas de la Mare to Redbourn,³⁴ which appears to have held also the manor of Beamonds.³⁵ The place was said to be worth £9 2*s.* a year in 1535,³⁶ but it is impossible to say what was then meant by the priory.

PRIORS OF REDBOURN

Gilbert de Sisseverne³⁷

Vincent, died January 1248-9³⁸

Geoffrey de St. Albans, occurs November 1290³⁹

Richard de Hatford, occurs January 1302, deposed soon afterwards⁴⁰

J. Woderove, occurs before 1383⁴¹

William de Flamstead, occurs 1380⁴²

William Wylum, occurs October 1396⁴³ and December 1401⁴⁴

Hugh Legat, resigned 1427⁴⁵

William Bryth, appointed 1427⁴⁶

Richard Myssendene, appointed 11 November 1428⁴⁷

³³ The secular benefactors are given in Lansd. MS. 260, fol. 302. Of the donations the chief were 5 quarters of wheat from Sir John Bibbesworthe, kt., 66*s.* 8*d.* from William Hemelhemstead, 20*s.* each from Sir Adam Newenham and Alice Lightfoote, and 20*s.* to the work of the kitchen, and 7*s.* for a pittance bequeathed by Emma Imayne.

³⁴ *Gesta Abbat.* ii, 413.

³⁵ The site of the house was granted in 1540 with the manors called 'the Priory' of Redbourn and Beamonds as if they were connected (*L. and P. Hen. VIII.* xv, g. 611 [46]).

³⁶ *Valor Eccl.* (Rec. Com.), i, 451.

³⁷ He was prior at the time of the dedication of the church, which was performed by John Bishop of Ardfert in the presence of Abbot William de Trumpington, and therefore took place between about 1215, when John settled at St. Albans (*Matt. Paris, Chron. Maj.* iv, 501), and 1235, the date of William's death.

³⁸ Cott. MS. Nero, D vii, fol. 112 d.

³⁹ *Gesta Abbat.* ii, 6-7.

⁴⁰ *Ibid.* 53-4.

⁴¹ No definite date can be assigned to the transaction in which his name appears, viz., the buying of the new road through fear of the Flamstead men (*ibid.* iii, 258). He seems to have been the man made sub-prior of St. Albans in 1349 (*ibid.* ii, 381).

⁴² Cott. MS. D vii, fol. 81 d.

⁴³ *Gesta Abbat.* iii, 258.

⁴⁴ *Ibid.* 480.

⁴⁵ 'Chron. Rer. Gest.' in Amundesham, *Annales*, i, 13.

⁴⁶ *Ibid.*

⁴⁷ Lansd. MS. 375, fol. 26 d. He had been Prior of Beaulieu (Amundesham, *op. cit.* i, 30).

RELIGIOUS HOUSES

Thomas Westwode, occurs 16 January 1452⁴⁸
and 25 February 1465⁴⁹
Thomas Albon, occurs 5 August 1476,⁵⁰ 30 June
1480⁵¹ and June 1492⁵²

3. HERTFORD PRIORY

The Benedictine priory of St. Mary of Hertford, a cell of St. Albans Abbey, was built about the end of the 11th century¹ by Ralph de Limesi for six monks who were to be sent from St. Albans.² Ralph gave as endowment a good hide of land at Hertford, the church of Pirton with tithe of his land and that of his men and 2½ hides of land,³ the mill, pasture for the oxen of the monks' ploughs with his own and feed for their pigs in his woods; a carucate of land in Itchington (co. Warw.) and certain tithes there and in Ulverley in Solihull (co. Warw.),⁴ Cavendish (co. Suffolk), Bibbesworth in Kimpton (co. Herts.), Epperstone (co. Notts.), and 'Torp.'

The charter was confirmed between 1108 and 1123⁵ by Henry I, who granted the priory sac and soc, tol and team, infangthef and its own court. The monks received from Ralph later the church of Amwell with tithe,⁶ and from his wife Avice land of her dower in Bradwell, on condition that she had three corrodies⁷ from the priory while she lived, and that after her death another monk was added to the convent. Several other members of the Limesi family figure as protectors and benefactors. Alan, Ralph's son, besides confirming his father's gifts to the monks, granted the church of Itchington⁸; Gerard, his son,⁹ gave them land in Cavendish and Itchington and forbade interference with their jurisdiction in places owned by them¹⁰; John son of Gerard de Limesi¹¹ acquitted their

tenements within his fee of scutage and made over to them the church of Cavendish,¹² while from his sister Amabel de Limesi they acquired land in Bibbesworth.¹³

Their possession of the benefits granted was not always left unquestioned. In the reign of John they had to prove by their charters their exemption from services demanded of them in Amwell by Ralph de Limesi.¹⁴ About the same time Wiscard Ledet, owner of the chapel of Ramerick in Ickleford, disputed their right to the sum of 5s. payable apparently as tithe from the mill there. The monks, however, agreed to supply a chaplain to celebrate mass four days a week in Wiscard's chapel¹⁵ and were allowed the 5s. and 20d. more.

The question whether the Abbot of St. Albans or the Bishop of Lincoln ought to have jurisdiction over the priory was settled in 1219,¹⁶ when it was decided that the prior must be presented to the bishop and do canonical obedience to him for benefices in his diocese, but that he was to be appointed by the abbot, who also had the right to select and remove the rest of the convent and to check abuses there.

Gilbert, Earl Marshal, after the accident in the tournament at Ware, June 1241, was carried to Hertford Priory, where he died and his viscera were buried.¹⁷ Contrary to expectation, the occurrence was the reverse of profitable to the house: the earl's brother Walter at the time promised the convent a rent of 60s., but afterwards refused to fulfil his obligation, and subjected the prior to some persecution into the bargain.¹⁸

Small gifts were occasionally made to the monks for special purposes. Thus Richard de Puteo c. 1200 gave them 12 acres of land in Bibbesworth for their kitchen,¹⁹ and in 1258, at the instance of Abbot John,²⁰ once Prior of Hertford,²¹ a rent of 2s. was assigned to maintain the ornaments and lights of an altar, probably that of St. Mary, in their church.²²

The indulgence of ten days granted by the Bishop of Lincoln in 1302 to those going to the altar of St. Theobald in the priory and

⁴⁸ *Reg. of St. Albans* (Rolls Ser.), i, 12.

⁴⁹ *Ibid.* ii, 30.

⁵⁰ *Ibid.* 145.

⁵¹ *Ibid.* 228-31.

⁵² *Add. Chart.* 34350.

¹ It is said to have been founded in the time of Abbot Paul (1077-93) (*Gesta Abbat.* i, 56-7). Ralph died apparently in 1130 (Hunter, *Gr. Roll of the Pipe* 31 *Hen. I* [Rec. Com.], 60).

² Lansd. MS. 863, fol. 157 d.

³ The land in Hertfordshire was reckoned at £30. See charter of confirmation by Henry I (*ibid.* fol. 159 d.).

⁴ See *V.C.H. Warw.* i, 340, n. 8.

⁵ When Ranulf was chancellor (Lansd. MS. 863, fol. 159 d.).

⁶ Alan de Limesi's charter of confirmation (*ibid.* fol. 158).

⁷ She was to have three 'prebendas' when she chose (*ibid.*).

⁸ Lansd. MS. 863, fol. 158.

⁹ He occurs in 1161-2 (*Red Bk. of Exch.* [Rolls Ser.], 29).

¹⁰ Lansd. MS. 863, fol. 158 d.

¹¹ John de Limesi occurs in 1196-7 and 1199-1200 (*Red Bk. of Exch.* [Rolls Ser.], 110, 126). He died in 1212 or 1213 (*Rot. de Oblat. et Fin.* 1199-1216 [Rec. Com.], 507).

¹² Lansd. MS. 863, fol. 159.

¹³ Charter of David de Lindsey (*ibid.* fol. 159 d.), who was one of the Limesi heirs (Dugdale, *Hist. of Warwickshire*, 343; *V.C.H. Herts.* iii, 46).

¹⁴ *Abbrev. Plac.* (Rec. Com.), 95.

¹⁵ *Add. Chart.* 15470.

¹⁶ *Gesta Abbat.* i, 275-7.

¹⁷ *Matt. Paris, Chron. Maj.* iv, 136.

¹⁸ *Ibid.* 495.

¹⁹ *B.M. Chart. L. F. C. x*, 12. He held the land of John de Limesi.

²⁰ *Ibid.* vi, 1.

²¹ *Gesta Abbat.* i, 312.

²² *B.M. Chart. L. F. C. vii*, 6. Some of the work of Richard the Painter, 1240-50, was done here (*Matt. Paris, op. cit.* vi, 202).

A HISTORY OF HERTFORDSHIRE

making offerings²³ suggests that money was then needed for building. The fact that in 1318²⁴ and 1321²⁵ the prior was borrowing points in the same direction, though the extortions of the abbot from the cells at that time²⁶ would account for debts.

The prior in May 1309 went abroad,²⁷ probably to obtain the pope's confirmation of the election of Abbot Hugh de Eversden. Another prior, Nicholas de Flamstead, a notably good and able man, accompanied Richard de Wallingford, abbot-elect, to the papal court in 1327.²⁸ His connexion with the priory seems then to have terminated. As cellarer of the abbey he came to the priory in 1331 to make provision for the entertainment there of the justices of Trailbaston.²⁹

As far as can be judged, the house throughout the 14th century was quietly prosperous. It was one of the three cells to give a present to Abbot Richard in 1327,³⁰ and made its contribution to the expenses incurred by Abbot Thomas de la Mare in obtaining the substitution of a fixed annual payment for the sums due to the king and pope, when some cells had to be excused owing to debt.³¹ Yet it was not among the richest of the St. Albans cells: its share of the above yearly payment was fixed by Abbot John de la Moote (1396-1401) at 30s., the smallest but one.³²

The house in 1461-2³³ was extremely unlucky in its prior, Thomas Walden. The payments made to him within this time and not entered in his accounts amounted to £50 at least, and the goods³⁴ alienated by him, not counting jewels, to £46 more. The priory was ill able to stand such malversation of its funds. The accounts for 1488-9 show that the receipts, £115 10s. 0½d., did not quite cover expenses,³⁵ and in 1497-8 the income of £90 10s. 3½d. barely sufficed.³⁶

The priors during this period were not always well chosen. John Bensted,³⁷ prior in 1489, apparently left the house £12 poorer than he

found it.³⁸ William Waterman, prior a little later, had a suit brought against him in Chancery for appropriating plate valued at 20 marks and £5 in money entrusted to him by a widow named Alice Newbury.³⁹ He declared that she had given them to him to reimburse him for paying her debts, but this she absolutely denied, though she acknowledged she owed him 5 marks which she professed herself ready to pay on the restoration of her property. Even if the case against Waterman was not so bad as it seems, it was not to his credit.⁴⁰

The proportion of income spent in law and travelling expenses in 1497-8, £11 16s. out of £90 10s., is also rather significant, considering the past record of the prior, William Dyxwell.⁴¹ The receipts in 1525-6, £85 15s. 9½d., were £5 above the expenditure,⁴² but whether the financial soundness of the house was due to wise administration is doubtful. The convent apparently numbered only four, including the prior,⁴³ and £42 had been spent on the kitchen and hospice,⁴⁴ so that unless food was at famine prices hospitality there must have been on a lavish scale.

The grant of the priory and its property by the king to Anthony Denny on 9 February 1538⁴⁵ appears to prove that the house was then already dissolved. Yet from a settlement about the tithes of Amwell it was presumably still in existence in July 1539⁴⁶; if so its end was no doubt delayed till the fall of St. Albans.

Its possessions, in 1297 worth about £30 or £40 a year,⁴⁷ were reckoned in 1535 to be of the clear annual value of £72 14s. 2½d.⁴⁸

³⁸ Sir Edward Bensted, kt., directed in his will in 1517 that £12 should be delivered to the Prior and convent of Hertford in recompense of such money and goods as his brother John Bensted found there at his first coming (W. F. Andrews, 'Sir Edward Bensted, kt.,' *East Herts. Arch. Soc.* ii [2], 190).

³⁹ Early Chan. Proc. bdle. 151, no. 27-30.

⁴⁰ There is probably little to be said in his favour. He was one of the two monks of St. Albans who behaved with disgraceful violence to Elizabeth Webbe, Prioress of Sopwell, in removing her from office (*ibid.* bdle. 181, no. 4).

⁴¹ See St. Albans.

⁴² Aug. Off. Misc. Bks. cclxxii, fol. 77.

⁴³ A stipend of £4 was paid to the prior and 40s. each to three other monks, a mark extra being given to the one who had charge of the church of St. John.

⁴⁴ It is headed expenses of the hospice, but it clearly corresponds to the payments for the kitchen and prior's hospice or guest-house of the earlier accounts.

⁴⁵ Pat. 29 Hen. VIII, pt. ii, m. 19.

⁴⁶ Add. Chart. 35315. It may be noted that the commissioners in March 1537 did not take the surrender of the house, but sent the prior to the Court of Augmentations (Land Rev. Rec. bdle. 66, no. 3).

⁴⁷ The property mentioned in *Pope Nich. Tax.* (Rec. Com.) amounts to £29 13s. 11½d., but it does not include the church of Amwell, which appears, however, at that time to have been appropriated to the priory and was worth £12 (Harl. MS. 60, fol. 30).

⁴⁸ *Valor Eccl.* (Rec. Com.), i, 451.

²³ Lincoln Epis. Reg. Memo. Dalderby, fol. 44. It was a ratification of the indulgence granted by the Bishop of Spoleto while papal nuncio in England.

²⁴ *Cal. Close*, 1313-18, p. 596.

²⁵ *Ibid.* 1318-23, p. 360. ²⁶ *Gesta Abbat.* ii, 130.

²⁷ *Cal. Pat.* 1307-13, p. 112.

²⁸ *Gesta Abbat.* ii, 186-7.

²⁹ *Ibid.* 222. ³⁰ *Ibid.* 187. ³¹ *Ibid.* 456.

³² *Ibid.* 468. Hatfield Priory paid the same, Beaulieu 6s. 8d. ³³ Mins. Accts. bdle. 865, no. 15.

³⁴ Among these were 3 bowls, 6 spoons, a silver 'poudyrbok,' 2 towels, 10 napkins, 2 candelabra, a pair of sheets, a portifory and certain muniments.

³⁵ Mins. Accts. Hen. VII, no. 1696.

³⁶ Rentals and Surv. R. 277.

³⁷ John Bensted, gentleman, son of Edward Bensted, esq., master of the game, was received as a monk at St. Albans 11 July 1470, and was then fifteen years old (*Reg. of St. Albans*, ii, 90).

RELIGIOUS HOUSES

PRIORS OF HERTFORD

Ralph, the first prior ⁴⁹
 Nigel, c. 1200 ⁵⁰
 William de Sandruge, instituted 1213 (?), ⁵¹
 died July 1222 ⁵²
 John, instituted January 1223, ⁵³ became
 Abbot of St. Albans 1235 ⁵⁴
 Richard, instituted 1237 ⁵⁵
 Nicholas, instituted 1241 ⁵⁶
 Simon, died September 1247 ⁵⁷
 Richard, occurs 1252, ⁵⁸ died 1253 ⁵⁹
 Thomas Martel, instituted 1254-5 ⁶⁰
 William de Hertford, instituted January
 1270-1 ⁶¹
 Mark de St. Edmund, instituted September
 1276 ⁶²
 William de Romeseye, instituted 1299 ⁶³
 Richard de Hertford, instituted July 1303, ⁶⁴
 Richard occurs 1309 ⁶⁵
 William de Kirkeby, instituted 1312 ⁶⁶
 John de Walsingham, instituted 1315 ⁶⁷
 William de Kirkeby, instituted 1316 ⁶⁸
 Stephen de Withenden, instituted 1317 ⁶⁹
 Richard de Wathamstede, instituted 1318 ⁷⁰
 Geoffrey de St. Albans, instituted 1323 ⁷¹
 Nicholas de Flamstede, occurs 1327 ⁷²
 Adam de Doncaster, instituted 1350 ⁷³
 Robert Nony, instituted 1352 ⁷⁴
 John de Colby, occurs April 1389 ⁷⁵

William Wynselowe, occurs 9 October 1396, ⁷⁶
 10 January 1397-8, ⁷⁷ October 1398, ⁷⁸
 12 December 1401 ⁷⁹
 William Giles, occurs 1420 ⁸⁰
 William Ellis, occurs 1423 ⁸¹
 William Brit, occurs 1429 ⁸²
 John Welles, occurs 16 January 1452 ⁸³
 Thomas Walden, occurs 25 March 1461-
 25 December 1462 ⁸⁴
 John Welles, appointed 1463, ⁸⁵ occurs 1465 ⁸⁶
 Richard Lamplew, occurs 1476, ⁸⁷ made prior
 for life 1 August 1484, ⁸⁸ died 1489 ⁸⁹
 John Bensted, occurs 25 March-29 September
 1489 ⁹⁰
 William Waterman, occurs c. 1490-3 ⁹¹ (?)
 William Dyxwell, occurs 29 September 1497-
 29 September 1498 ⁹²
 John Kelyngwurthe, occurs 16 September
 1507 ⁹³ and 1511 ⁹⁴
 Thomas Hampton, occurs 1512-13, ⁹⁵ Feb-
 ruary 1520, ⁹⁶ June 1525-June 1526, ⁹⁷ Janu-
 ary 1537 ⁹⁸ and July 1539 ⁹⁹

The seal attached to a charter of 1520¹⁰⁰ is a large 13th-century vesica. On it is represented a half-length figure of the Virgin standing, and holding on her left arm the Child, whose head is surrounded by a cruciform nimbus. All that remains of the broken legend is SANCTE. [M]ARIE. [DE.H]ERTO.

⁴⁹ Ralph the prior witnessed the charter of foundation (Lansd. MS. 863, fol. 157 d.). He also witnessed the charter of the founder's son Alan (ibid. fol. 158).

⁵⁰ He was contemporary with John de Limesi (ibid. fol. 159). See also B.M. Chart. L. F. C. x, 12, and Add. Chart. 15470.

⁵¹ The Prior of Hertford died in this year (*Ann. Mon.* [Rolls Ser.], 41), so that William may have been appointed then.

⁵² Matt. Paris, op. cit. vi, 270.

⁵³ *R. of Hugh de Welles* (Cant. and York Soc.), iii, 44-5.

⁵⁴ *Gesta Abbat.* i, 312.

⁵⁵ Clutterbuck, *Hist. and Antiq. of Herts.* ii, 152.

⁵⁶ Ibid.

⁵⁷ Matt. Paris, op. cit. iii, 277.

⁵⁸ Feet of F. Herts. 36 Hen. III, no. 413.

⁵⁹ Matt. Paris, op. cit. vi, 279. Here called Richard de Wendene.

⁶⁰ Lincoln Epis. Reg. Rolls Lexington (Huntingdon Arch. Anno 1).

⁶¹ Clutterbuck, op. cit. ii, 152.

⁶² Ibid.

⁶³ Lincoln Epis. Reg. Inst. Sutton, fol. 92 d.

⁶⁴ Clutterbuck, loc. cit.

⁶⁵ *Cal. Pat.* 1307-13, p. 112.

⁶⁶ Lincoln Epis. Reg. Inst. Daldery, fol. 245.

⁶⁷ Ibid. fol. 249 d. ⁶⁸ Ibid. fol. 250 d.

⁶⁹ Ibid. fol. 252. ⁷⁰ Ibid. fol. 254 d.

⁷¹ Ibid. Inst. Burghersh, fol. 365.

⁷² *Gesta Abbat.* ii, 187.

⁷³ Lincoln Epis. Reg. Inst. Gynwell, fol. 345.

⁷⁴ Ibid. fol. 352.

⁷⁵ Ibid. Memo. Buckingham, ii, fol. 357.

4. SALBURN PRIORY IN STANDON

The Benedictine priory of St. Michael of Salburn in Standon was a cell of the priory of

⁷⁶ *Gesta Abbat.* ii, 425.

⁷⁷ Lond. Epis. Reg. Braybrook, fol. 345 d. Here no surname is given.

⁷⁸ Add. Chart. 40755.

⁷⁹ *Gesta Abbat.* ii, 480.

⁸⁰ Clutterbuck, op. cit. ii, 152.

⁸¹ Ibid.

⁸² He was made Prior of Binham about the autumn of 1429 (Amundesham, *Annales*, i, 42).

⁸³ *Reg. of St. Albans* (Rolls Ser.), i, 10.

⁸⁴ Mins. Accts. bde. 865, no. 15.

⁸⁵ Ibid.

⁸⁶ *Reg. of St. Albans*, ii, 30.

⁸⁷ Ibid. 145. ⁸⁸ Ibid. 268.

⁸⁹ Mins. Accts. Hen. VII, no. 1696.

⁹⁰ Ibid.

⁹¹ Early Chan. Proc. bde. 151, no. 27-30. The document can only be approximately dated as from 1486 to 1493 or 1504 to 1515.

⁹² Rentals and Surv. R. 277.

⁹³ Harl. Chart. 75 G 5.

⁹⁴ Clutterbuck, op. cit. ii, 152.

⁹⁵ Dugdale, *Mon.* iii, 299.

⁹⁶ B.M. Chart. L. F. C. x, 13. No surname given.

⁹⁷ Aug. Off. Misc. Bks. cclxxii, fol. 77.

⁹⁸ Add. Chart. 35477.

⁹⁹ Ibid. 35315.

¹⁰⁰ B.M. Chart. L. F. C. x, 13.

A HISTORY OF HERTFORDSHIRE

Stoke by Clare. Between 1173 and 1178¹ Richard de Clare Earl of Hertford granted to his monks of Stoke the hermitage of Standon which William the Anchorite built, that they might celebrate service there to the honour of St. Michael, St. John Baptist and St. John the Evangelist for him and his relatives, saving, however, the right, peace and quiet of William the Anchorite.²

It was apparently the earl's intention to establish a community of religious there, and the hermitage was probably for a time a cell of Stoke, for in the 13th century it was known as the house of St. Michael of Salburn,³ and several grants⁴ were made by various persons to the 'brothers of Salburn.'⁵

From the beginning of the 14th century there is no sign of any community here. In 1306 Roger de Castone, chaplain, was made brother of the Chapel of Salburn,⁶ but as the expression 'house' never occurs again in this connexion the place had no doubt already become a free chapel,⁷ and is so named in 1384⁸ when the king presented owing to the minority of the patron. The anchorite William had successors: Richard le Hermit⁹ of Salburn

obtained papal confirmation for certain gifts made to him¹⁰; Brother John the hermit is mentioned in the Standon Court Rolls in 1357,¹¹ and John Benwell, hermit chaplain, received the hermitage of Salburn in 1398.¹²

The chapel was leased to different people by Stoke College¹³ from 1471 to 1516,¹⁴ at first for 30s. a year, later for 26s. and finally for 20s.

WARDENS OR CHAPLAINS OF SALBURN

John de Salburn, chaplain, appointed 27 May 1269¹⁵

Roger de Castone, chaplain, appointed 11 June 1306¹⁶

Andrew, chaplain, occurs 1351¹⁷

Robert de Lincoln, king's clerk, appointed 1384¹⁸

Simon Bynham, chaplain, appointed 1392¹⁹

John Benwell, hermit chaplain, appointed 1398²⁰

A seal of the 13th century,²¹ in shape a pointed oval, shows St. Michael trampling on the dragon and piercing its head with a long cross. Legend: s'. DOMVS SĀI MICAELIS D'SALEBVRNE.

HOUSES OF BENEDICTINE NUNS

5. SOPWELL PRIORY

The Benedictine nunnery of St. Mary of Sopwell, near St. Albans, is said by Matthew Paris to have owed its foundation to the building by Geoffrey, sixteenth Abbot of St. Albans (1119-46), of a cell and houses for two holy women who had settled near Eywood about 1140 in rough shelters made of branches of trees wattled together.¹ His account cannot be

¹ Richard succeeded his father Roger in the earldom in 1173 or 1174 (*Dict. Nat. Biog.* x, 397), and Gilbert Bishop of London, to whom the charter is addressed, died in 1178.

² Extract from the register of Stoke by Clare, printed in Dugdale, *Mon.* vi, 1658.

³ B.M. Seals, xliii, 13; appointment of a warden of the house of Salburn 27 May 1269 (List of Muniments of Edmund Earl of March in Add. MS. 6041, fol. 73).

⁴ These cannot be dated.

⁵ Add. MS. 6041, fol. 73, no. 5-9, 11-14, 16-18.

⁶ *Ibid.* no. 20.

⁷ On 3 May 1325 the warden of the *Chapel* of Salburn asked to be relieved of his charge (*ibid.* no. 21), and on 16 May 1334 Elizabeth de Burgh, Lady of Clare, appointed a warden of the *Chapel* of Salburn (*ibid.* no. 22).

⁸ *Cal. Pat.* 1381-5, p. 488.

⁹ A hermit of course was not the same as an anchorite, but the word is often used in the sense of anchorite.

¹ *Gesta Abbat.* i, 80-2.

altogether correct, for the cell first occupied by the convent was an ankerhold repaired or rebuilt by a recluse named Roger.² Still, the

¹⁰ Add. MS. 6041, fol. 73, no. 7.

¹¹ Ct. R. portf. 178, no. 44.

¹² *Cal. Pat.* 1396-9, p. 416. But in this case the free chapel was apparently granted to a man who happened to be a hermit or anchorite. There was probably no longer a hermit in addition to the chaplain at Salburn.

¹³ In 1415 the priory had been changed into a college of secular priests.

¹⁴ Harl. Chart. 44 I 30-50.

¹⁵ Add. MS. 6041, fol. 73, no. 19.

¹⁶ He became 'brother in the chapel of Salburn' (*ibid.* no. 20).

¹⁷ He is called chaplain of the chapel of Salburn (Ct. R. [Gen. Ser.], portf. 178, no. 42, m. 2 d.).

¹⁸ *Cal. Pat.* 1381-5, p. 488.

¹⁹ *Ibid.* 1391-6, p. 241. He was granted the chapel or hermitage of St. Michael, Salburn, on condition that he stayed there and celebrated service.

²⁰ *Ibid.* 1396-9, p. 416. ²¹ B.M. Seals, xliii, 13.

² Grant of Henry de Albin (Dugdale, *Mon.* iii, 365, no. ii). It would almost seem that in the *Gesta Abbat.* the origins of Markyate and Sopwell have been confused. There Markyate Priory (op. cit. i, 98-193) is said to have arisen through the occupation of the hermitage of Roger, a former monk of St. Albans, by a saintly recluse called Christina, for whom Abbot Geoffrey built a house. But in reality Markyate was not dependent on St. Albans, as it would have been if founded by the abbot, and as Sopwell was.

RELIGIOUS HOUSES

house apparently arose in Geoffrey's time,³ and as very early in its history it became dependent on St. Albans, the abbot was probably concerned in its foundation,⁴ with the object no doubt of accommodating the nuns who existed at St. Albans Abbey through the Saxon period down to about this date.

While Geoffrey was abbot the cemetery of the nuns was consecrated by Bishop Alexander, probably Alexander Bishop of Lincoln (1123-48), and it was then ordained that without the consent of the abbot none might enter the convent, the number of which was limited to thirteen.⁵ Geoffrey is also said to have directed that the nuns for their safety and good name were to be locked in at night under the abbot's seal, and that maidens only were to be received into the community.⁶

Among the earliest grants to Sopwell were those of Henry de Albini⁷ and his son, the former giving in frankalmoign 2 hides of land in his manor of Cotes, in Cardington parish, co. Bedford,⁸ and the other adding a virgate in the same place when his sister Amicia became a nun at Sopwell⁹; Roland de Dinan's gift to the nuns of half a hide in Ickleford; Richard de Tany's¹⁰ grant of land called Black Hide in the soke of Tyttenhamer¹¹; that of Hugh de Keynes¹² of a hide in Croughton, co. Northants.¹³ Other benefactions included assarted land in Shenley,¹⁴ the yearly allowance of 50s.

³ Henry de Albini's gift was made for the souls of the Conqueror and his sons, so that it was probably not earlier than 1135, while the wording of the grant 'to the work of the cell and the nuns' suggests that the house had just been established. The gift of Henry's son Robert to Sopwell was witnessed by Abbot Geoffrey (Dugdale, *Mon.* iii, 365, no. iii).

⁴ See St. Albans.

⁵ Charter witnessed by the bishop and the abbot (*Gesta Abbat.* i, 81-2). The rule as to numbers was perhaps made in view of the convent's income, to be set aside if this increased; it was certainly disregarded. Abbot John blessed fourteen nuns at Sopwell in 1212 and there were at least nineteen here in 1338 (*ibid.* i, 232; ii, 212).

⁶ *Ibid.* i, 81.

⁷ He was a benefactor of St. Albans (Dugdale, *Mon.* ii, 220).

⁸ *Ibid.* iii, 365.

⁹ *Ibid.*

¹⁰ It is witnessed by his son and heir Reginald, probably the Reginald de Tany who occurs in 1156 (Cussans, *Hist. of Herts. Hund. of Hertford*, 34).

¹¹ Dugdale, *Mon.* iii, 365, no. vi.

¹² Hugh de Keynes occurs in 1140 (Baker, *Hist. of Northants*, i, 350).

¹³ *Anct. D.* (P.R.O.), A 5065.

¹⁴ Confirmation temp. Henry III by grandson of donor (*ibid.* B 3218), Ralph de Chenduit, who occurs temp. Henry II (Hearne, *Black Bk. of Exch.* i, 208). The nuns also received in the 13th century rents in St. Albans and elsewhere (*Anct. D.* [P.R.O.], A 996, 1140, 1152, B 125; *Cal. of Chart. in Bodleian Lib.* 677; *Cal. Pat.* 1272-81, p. 459; *Cart. Misc. Augment. Off.* vol. xv, no. 67), and land between Eywood and the nuns' orchard from Warin de Redbourn (*Anct. D.* [P.R.O.], B 1371).

from the issues of Hertfordshire, granted in 1247 by Henry III to support a chaplain celebrating daily the mass of the Virgin,¹⁵ a rent of 5s. in West Wycombe received in 1281¹⁶ from Henry de Norwyco, whose daughter Philippa was a nun at Sopwell in February 1266-7, and was then promised by Abbot Roger the first livery to fall vacant of the three called the Maundy of St. Mary, delivered daily from the abbey's refectory and kitchen.¹⁷

The convent, apparently not satisfied with its dependent position, on one occasion tried to elect the prioress. On the death of Prioress Philippa, c. 1330, they talked the matter over among themselves, and the majority decided on Sister Alice de Hakeneye.¹⁸ The Abbot of St. Albans hearing what had occurred sent Nicholas de Flamstede, the prior, to the priory unexpectedly. He said that although the abbot had the right to select their head he wished to hear their opinions, and asked each to state her choice in writing. Sixteen and more gave their votes for Alice de Hakeneye, about three for the sub-prioress, Alice de Pekesden. Nicholas, however, by previous instructions from the abbot, declared Alice de Pekesden prioress and installed her. She was probably indeed the best fitted for the post, for she is said to have been more zealous for religion than all the rest.

A glimpse of the state of the house twenty years later is afforded by the injunctions issued by Abbot Michael in 1338 after a visitation.¹⁹ These order that the nuns were to sing the mass of St. Alban once a week with a few exceptions; that no sister undergoing the penance of silence was to be debarred from religious exercises or from seeing mass celebrated; that the custom of the chaplain of our Lady to help the confessor at certain services was to be observed; that when it was time to rise the sub-prioress was to ring the bell in the quire and no one was to leave the dormitory before without permission, all must then get up and attend the mass of our Lady, and after this sit in the cloister occupied with their private devotions until Prime, at which all except the sick were to be present, then they should attend the chapter and in the interval until their meal go about their work; the doors of the garden and parlour were to be closed when curfew was sounded at the abbey, and the

¹⁵ *Cal. Chart. R.* 1226-57, p. 312.

¹⁶ *Cal. Pat.* 1272-81, p. 459.

¹⁷ *Reg. of St. Albans*, ii, 339, App. D.

¹⁸ *Gesta Abbat.* ii, 212.

¹⁹ He said that he had heard that certain good customs that used to be observed by them were now omitted, while various abuses were maintained, and then ordered the observance of the customs as renewed by him (Dugdale, *Mon.* iii, 365-6, no. vi). Also printed and translated by Riley in *Gesta Abbat.* ii, App. D, pp. 511-19.

A HISTORY OF HERTFORDSHIRE

door of the garden should not be opened before Prime; that in chapter only three persons should speak—the president, sub-prioress or her substitute, and the sister charged with an offence; those disobedient to the prioress in chapter were to be put on bread and water for the day; that all who broke the silence ordered by their rule should acknowledge their fault in chapter and receive regular discipline, and if they did not do so voluntarily they should be charged by the guardian of the order and have the hardest penance; that those who quarrelled and thus created disorder should not be spoken to and be in penance for three days; that the sisters were not to come into the parlour to speak to secular persons except with neck and face covered with kerchief and veil as ordained by their order; that only persons of good fame were to be allowed to enter the priory and were never to eat in the nuns' rooms without the abbot's special permission; that workpeople such as tailors and furriers employed at the priory must be respectable, and should have a place near the cloister set apart for them, and were never to be called into the rooms; that nuns who were ill were to be in the infirmary according to the custom formerly observed; the prioress was forbidden to give leave to the nuns to remain with guests for the night and the dormitory was to be occupied by the sisters only. These rules perhaps suggest precautionary measures rather than indicate great lack of discipline.

The orders given by Abbot Thomas²⁰ (1349–96) to the Warden or Master of Sopwell show the necessity of more care: henceforth no man, secular or regular, was to be allowed to enter the nunnery without the abbot's permission, and then not before Prime had been sung, and he was not to stay after the bell had been rung for supper at St. Albans; and the master himself was always to enter and leave in the company of others and not to remain longer than the time fixed above, except in special circumstances.

There are occasional references to individual nuns that are not without interest. Agnes Paynel figures in the Book of Benefactors of St. Albans²¹ for her gift of three copes with beautiful orphreys, chasuble, tunic and dalmatic of black satin, powdered with stars and the letters A and P in gold, for her monetary contributions to various works of the abbey and a gold ring offered to St. Alban's shrine. Letitia Wyttenham, prioress 1418–35, also ranked as a benefactor²² on account of her industry in embroidering and mending the vestments of St. Albans. Cecilia Paynel and Margaret Euer, nuns of Sopwell, were admitted to the fraternity

of St. Albans in 1428 on the same day as the Earl of Warwick's household.²³ Lady Margaret Wynter made regular profession at Sopwell in June 1429,²⁴ and offered a girdle enriched with precious stones worth 10 marks.²⁵ Two more nuns mentioned in the 15th century were of London citizen families, and received bequests, the one²⁶ of a mark, the other²⁷ of 2 marks a year.

Visitors of high rank were not uncommon at the time of Margaret Wynter's admission. The Duke of Gloucester in 1427 and Cardinal Beaufort in 1428 called at the nunnery on their way from St. Albans to Langley,²⁸ and the Duchess of Clarence was apparently staying at Sopwell in 1429, when she was received into the fraternity of St. Albans.²⁹ One of the convent's guests was the cause of an alarming attack on the priory in 1428.³⁰ William Wawe, the famous robber-captain, expecting to find a certain Eleanor Hulle³¹ there, broke into the place with his men one night. After terrifying the nuns with threats they began to plunder, when hue and cry was raised by an energetic man in the village,³² and the robbers made off.

Abbot William Wallingford on 8 March 1480–1 commissioned John Rothbury, the archdeacon, and Thomas Ramrugge, sub-prior of St. Albans, to visit the house of Sopwell and remove the prioress, Joan Chapel, from her office on account of her age and infirmities, putting Elizabeth Webbe in her place.³³ The abbot must have regretted his choice afterwards. When Rothbury some years later deposed her she brought an action against him

²³ Amundesham, *Annales*, i, 67.

²⁴ The title 'Lady' was used then in a less restricted way than at present.

²⁵ Amundesham, *Annales*, i, 40.

²⁶ Joan Welles, granddaughter of Richard Odyham, grocer of London (*Sharpe, Cal. of Wills proved in Ct. of Husting, London*, ii, 474).

²⁷ Amy daughter of John Godyn, grocer of London (*ibid.* 564–5).

²⁸ Amundesham, *op. cit.* i, 13–28.

²⁹ *Ibid.* 40. From this passage it has been imagined (*Dugdale, Mon.* iii, 363) that the duchess was a nun at Sopwell, but this appears to be a mistake. She intended in 1429 to settle near Syon Monastery to receive spiritual benefits from the priests there (*Cal. Papal Letters*, viii, 149).

³⁰ Amundesham, *op. cit.* i, 11.

³¹ This lady was of some influence at the court of Henry V. She was partly instrumental in introducing to the king's notice Thomas Fischborn, the monk of St. Albans who obtained a dispensation to become a secular priest (*ibid.* 27). In 1417 she was in the service of Queen Joan and received a pension of 50 marks (*Cal. Pat.* 1416–22, p. 304). She is mentioned among the benefactors of St. Albans, see *Dugdale, Mon.* ii, 222.

³² Roger Husewyf, who took priest's orders in 1430 (*Amundesham, op. cit.* i, 49).

³³ *Reg. of St. Albans*, ii, 239.

²⁰ *Gesta Abbat.* iii, 519.

²¹ Cott. MS. Nero, D vii, fol. 104 d.

²² *Ibid.* fol. 148 d.

RELIGIOUS HOUSES

in the Court of Arches and was reinstated. Upon this two monks of St. Albans, sent by Rothbury, came to the nunnery, broke down Elizabeth's door with an iron bar, beat her and put her in prison.³⁴ She then appealed to the Archbishop of Canterbury as chancellor,³⁵ and it can hardly be doubted that she was the authority for some of Morton's charges against St. Albans. In his letter to the abbot, 5 July 1490,³⁶ he accused him of changing the prioresses not only at Pré but at Sopwell as he pleased, and deposing the good and religious for the benefit of the evil and vicious, so that religion was cast down and needless expense caused. He also said that the monks put in as wardens used their opportunities to dissipate the goods of these houses, and he no doubt had grounds for his statement. In 1500-1 Elizabeth Prioress of Sopwell, probably the same Elizabeth Webbe, complained to the chancellor³⁷ that a deed of lease by the convent had been secretly altered to their disadvantage by Thomas Holgrave, keeper of the priory, and his clerk, who had been bribed by the tenant.

The house was dissolved in March or April 1537³⁸ under the Act of 1536. Very different reports of Sopwell were given by John ap Rice in October 1535,³⁹ and the commissioners sent to receive the surrender in March 1537,⁴⁰ the first telling Cromwell that, as he would see by the 'comperta,' it would be well to suppress the priory, the others declaring that the five nuns composing the convent were of good character.

There were then two children living at the priory, probably for instruction by the nuns.⁴¹

A pension of £6 a year was assigned to the prioress, Joan Pygot⁴²; the other nuns, a priest and four servants received £10 5s. 8d. among them.⁴³ The buildings, which were in

a fair state of repair, contained little of much value beyond the lead on the roofs, priced at £40, and the four bells, reckoned at £18.⁴⁴ The plate consisted of a silver-gilt chalice and paten weighing 14 oz.⁴⁵ The furniture of the church,⁴⁶ including an alabaster table, the hanging of the quire, two altar frontals,⁴⁷ and a copper cross, was sold for £1 15s. 6d.; the timber-work of the quire for 40s.; the stone in the church with the vestry staff for 60s.; and the stuff in the parlour for 10s.⁴⁸

The net income of the priory was reckoned in the Valor of 1535 at £40 7s. 10d.,⁴⁹ at the suppression at £46.⁵⁰

PRIORESSES OF SOPWELL

E., occurs 1233⁵¹

Philippa, occurs September 1310,⁵² 1324,⁵² and 1327⁵⁴

Alice de Pokesden, appointed c. 1330⁵⁵

Margaret Fermeland, occurs February 1341⁵⁶

Joan, occurs 6 January 1370-1⁵⁷ and March 1383-4⁵⁸

Matilda de Flamstead, occurs 28 September 1388,⁵⁹ resigned or was removed before 20 September 1412⁶⁰

⁴⁴ Mins. Accts. Hen. VIII, no. 1606.

⁴⁵ Aug. Off. Misc. Bks. ccclxi, fol. 63. The sum total of goods and plate came to £11 8s. 9d.; in the inventory of the commissioners made just before the suppression (K.R. Church Goods, $\frac{1}{3}\frac{2}{0}$) it was estimated at only 76s. 11d., but the list of goods included neither timber nor stone.

⁴⁶ The vestments were of the poorest kind: a cope valued at 12d., a vestment of old black velvet priced at 2s. 4d., two tunics of baudekin, two others very old, a vestment of black cloth, and another for Lent valued at 16d., 2s., 12d. and 6d. respectively (ibid.).

⁴⁷ The frontal of an altar, 20d., the front of another altar, 12d. (Aug. Off. Misc. Bks. ccclxi, fol. 63). The second altar was probably that of St. Katharine mentioned in 1445 (*Herts. Gen. and Antiq.* iii, 140).

⁴⁸ Aug. Off. Misc. Bks. ccclxi, fol. 63.

⁴⁹ *Valor Eccl.* (Rec. Com.), i, 451. The sum only is given and not the sources from which it was derived; possibly the difference of nearly £6 is caused by the annuities being reckoned in one case and not in the other.

⁵⁰ Transcript of Land Rev. Rec. bdle. 66, no. 3.

⁵¹ Anct. D. (P.R.O.), D 285.

⁵² Ibid. D 611.

⁵³ Cart. Misc. (Aug. Off.), vol. xi, no. 119.

⁵⁴ Plac. de Banco R. 269, m. 12 d.

⁵⁵ At the death of Philippa (*Gesta Abbat.* ii, 212).

⁵⁶ Anct. D. (P.R.O.), D 1286.

⁵⁷ Ibid. A 5443.

⁵⁸ Ibid. D 419.

⁵⁹ Ibid. D 463.

⁶⁰ Alice Charleton then bequeathed 6s. 8d. to Matilda Flamstead, late Prioress of Sopwell (*Herts. Gen. and Antiq.* i, 47). She died in Feb. 1431-2, aged eighty-one years, having been in religion seventy-one years (*Amundesham, Annales*, i, 61).

³⁴ Early Chan. Proc. bdle. 181, no. 4.

³⁵ The petition is not dated, but the archbishop addressed is obviously Morton (chancellor 1486-93), and not Warham (chancellor 1504-15), because Rothbury predeceased Abbot William de Wallingford (see Early Chan. Proc. bdle. 97, no. 6), i.e., he died before 1492.

³⁶ Wilkins, *Concilia*, iii, 632.

³⁷ Early Chan. Proc. bdle. 245, no. 28.

³⁸ The date is given in Mins. Accts. Hen. VIII, no. 1606, as 14 April, but the surrender appears from *L. and P. Hen. VIII*, xii (1), 571 (1), to have taken place in March.

³⁹ *L. and P. Hen. VIII*, ix, 661.

⁴⁰ Transcript of Land Rev. Rec. bdle. 66, no. 3.

⁴¹ In the Warden's Accounts of 1446 there is entered the payment of 22s. 6d. from Lady Anne Norbery for commons of her daughter, apparently a boarder here (Rentals and Surv. R. 294).

⁴² Mins. Accts. Hen. VIII, no. 1606. It was still paid in 1555 (Add. MS. 8102, m. 9).

⁴³ Mins. Accts. Hen. VIII, no. 1606.

A HISTORY OF HERTFORDSHIRE

Letitia,⁶¹ occurs 29 September 1418,⁶²
10 October 1419,⁶³ 1434 and 29 September
1435⁶⁴
Eleanor, occurs 4 November 1465⁶⁵
Joan Chapel, removed March 1480-1⁶⁶
Elizabeth Webbe, appointed March 1481,⁶⁷
occurs 1500 or 1501⁶⁸
Agnes Wakefield, occurs November 1528⁶⁹
Joan Pygot, occurs 2 March 1537⁷⁰

6. CHESHUNT PRIORY

Nothing is known about the foundation of the priory of St. Mary, Cheshunt,¹ for Benedictine nuns except that it took place before 18 December 1183, for Pope Lucius III then issued a bull in its favour.² By this its property was taken under the papal protection, the celebration of service was allowed there during an interdict, the nuns were to have their own chaplain to minister in their church, and a cemetery in which they and others who so desired could be buried; the election of the prioress was to belong to the convent and to be free; archbishops and bishops were not to levy undue contributions from them; and none was to molest them or carry off their possessions.

Henry II in 1186 made the nuns a gift from the issues of Winchester.³ In 1229 Henry III ordered that they should have peaceful possession of a virgate of land in Feltham, co. Middlesex, given them by William de Rivers,⁴ and in 1240 gave them all the lands and tenements formerly held by the canons of Cathale.⁵ Possibly this charter merely confirmed the grant of Humphrey de Bohun, Earl of Hereford and Essex,⁶ by which the

convent received all the land given to the brothers of Cathale by Humphrey's uncle, William de Mandeville, viz., that which lay between the priory's estate and the bounds of Enfield Park, pasture for 15 horses, 60 oxen, and 100 sheep, and pannage for pigs in the park, and a special entrance into the park for them and their carts; in return they were to find a chaplain to celebrate for ever for the souls of William de Mandeville, Humphrey and his wife Maud.

The nuns in 1290 petitioned the king for help in distress caused by a fire, and although nothing was done then,⁷ in 1297 they were excused from payment of the eleventh out of compassion for their poverty.⁸ Not many years passed before the same misfortune again befell the priory. An undated petition from the nuns to the king and council,⁹ begging for a renewal of their charters destroyed by fire, says that their house, church and goods have been twice burned, to the great impoverishment of the convent; from their lands and rents they have an income of only £26 on which to support thirteen ladies, two chaplains and other ministers and servants, and they therefore ask that they may acquire more property in mortmain. To their first request assent was made, and the exemplification in 1315¹⁰ of the charter of 1240 seems to have been the result.

It was doubtless the priory's special need that moved the Bishop of Lincoln in 1312 to offer an indulgence of thirty days to those contributing to the fabric of the conventual church, dormitory and other places of the house, or to the maintenance of the 'poor handmaids of Christ' themselves.¹¹ The poverty of the convent was evidently considered by Ralph Bishop of London, their diocesan, in dealing with a case there in April 1309.¹² The nuns had elected a prioress whom the bishop refused to confirm as unfit for the post; he thought, however, that the difficulties of the house might perhaps be more quickly overcome by one of the convent than if a stranger were appointed; he therefore allowed them to elect a second time. The sale of their Feltham property in 1311¹³ may have been forced on them by necessity.

Protection to the prioress for two years was granted in 1323,¹⁴ 1325¹⁵ and 1331¹⁶ by the king.

⁷ *Parl. R. i*, 53a.

⁸ *Cal. Close*, 1296-1302, p. 115.

⁹ Anct. Pet. no. 1886, file 38.

¹⁰ *Cal. Pat.* 1313-17, p. 292.

¹¹ Linc. Epis. Reg. Memo. Daldery, fol. 237.

¹² *Reg. of Ralph Baldock* (Cant. and York Soc.), 106-7.

¹³ Anct. D. (P.R.O.), C 2433.

¹⁴ *Cal. Pat.* 1321-4, p. 323.

¹⁵ *Ibid.* 1324-7, p. 191.

¹⁶ *Ibid.* 1330-4, p. 108.

⁶¹ Letitia Wyttenham in Cott. MS. Nero, D vii, fol. 148 d.

⁶² Ct. R. (Gen. Ser.), portf. 178, no. 32.

⁶³ *Ibid.* no. 31.

⁶⁴ *Ibid.* no. 32. It has been supposed that Dame Juliana Bernes, Barnes, or Berners, author of *The Book of Sports and Heraldry*, was a Prioress of Sopwell in the 15th century, but no evidence has come to light in support of the story, though its truth is not impossible, as can be seen from the present list. It is perhaps more probable, if she was connected with the priory, that she was a lady boarder in it.

⁶⁵ Anct. D. (P.R.O.), A 2491.

⁶⁶ *Reg. of St. Albans*, ii, 239.

⁶⁷ *Ibid.*

⁶⁸ Early Chan. Proc. bdle. 245, no. 28. No surname is given.

⁶⁹ Aug. Off. Convent. Leases, iv, no. 140.

⁷⁰ *L. and P. Hen. VIII*, xii (1), 571 (1).

¹ Also called St. Mary of Swetmannescrofte, see *L. and P. Hen. VIII*, xi, 519 (12).

² Transcript made March 1459-60. London Epis. Reg. Fitz James, fol. 35.

³ Pipe R. 32 Hen. II, m. 12 d.

⁴ *Cal. Close*, 1227-31, p. 149.

⁵ *Cal. Chart. R.* 1226-57, p. 253.

⁶ Dugdale, *Mon.* iv, 329, no. ii.

RELIGIOUS HOUSES

The nuns were excused in November 1340¹⁷ from payment of the ninth of sheaves on pleading the insufficiency of their property for their maintenance and their previous exemption in consequence from all such contributions; and in October 1346¹⁸ the king ordered that the tenth and fifteenth should not be demanded of them. The convent escaped payment only by reiterated complaints,¹⁹ so that it was a great point gained when the king on 13 January 1352 granted²⁰ them a perpetual acquittance of all tenths, fifteenths, aids and charges whatsoever.

Edward III was apparently kindly disposed to them. On 8 September of that year he gave them licence to acquire in mortmain land and rent to the annual value of £10,²¹ and on 3 July 1358 granted them free warren in all their lands in Cheshunt.²² Moreover, when the nuns represented their extreme want to him again in 1367, saying that they had often had to beg in the highways, he ratified their property to them as desired,²³ and in 1370 made them a present of £10.²⁴

When Queen Isabella was on her way to Hertford in May 1358 the nuns came out to meet her, as they did every time she subsequently passed the priory.²⁵

There seems always to have been a close connexion between Cheshunt Nunnery and London. The value of its possessions in the city and suburbs in 1367 far exceeded that of its property elsewhere,²⁶ and it is mentioned frequently in wills of London citizens during the 14th and 15th centuries.²⁷ The bequests were often small, but not always. In 1392 Maud Holbech left 10 marks,²⁸ and in 1431 Thomas Elyng, rents in St. Lawrence Lane²⁹ to the house, which must have derived substantial

benefit from the legacies of Agnes Gyffard³⁰ and Richard Jepe, rector of All Hallows, Honey Lane.³¹ Agnes Gyffard's daughter Cecilia was a nun at Cheshunt,³² and personal ties may account in other instances for the interest of Londoners in the priory.

There is little information about the house except on the financial side. Tiphania Chamberleyn, the prioress, obtained a papal indult on 30 May 1352³³ to choose a confessor to give her plenary remission at the hour of death. When she died many years afterwards an irregularity of form made void the election of her successor, Agnes Amys, but the bishop, Robert Braybrook (1382-1405), finding her very suitable for the office, provided her to the priory by his authority.³⁴ Agnes Amys paid 20s. in 1415 for a confirmation of the Letters Patent exempting the convent from payment of aids,³⁵ which were again confirmed in 1429³⁶ and 1470.³⁷ Prioress Margaret Chawry had some litigation with Nicholas Cowper, vicar of Cheshunt. Sir Thomas Lovell, who had leased a farm of her in 1508, refused to pay tithes; Cowper therefore demanded them from her and took proceedings in the Consistory Court of the Bishop of London, Richard Fitz James.³⁸ The prioress won her case, whereupon Cowper appealed to the archbishop's court³⁹ and in 1520 to Rome.⁴⁰ Lovell died in May 1524 and Margaret wrote to Bishop Tunstall begging him to make Cowper drop the suit and pay her expenses and to induce Lovell's executors to make some recompense. She evidently felt that she had suffered because Lovell was too powerful to be coerced.⁴¹

The dissolution of the priory under the Act of 1536 occurred before 9 September of that year, the house and all its possessions being then granted by the king to Anthony Denny.⁴²

¹⁷ *Cal. Close*, 1339-41, p. 585.

¹⁸ *Ibid.* 1346-9, p. 104.

¹⁹ *Ibid.* 1341-3, pp. 221, 616; 1346-9, pp. 299, 427.

²⁰ *Cal. Pat.* 1350-4, p. 195.

²¹ *Ibid.* p. 319.

²² *Chart. R.* 32 Edw. III, m. 3, no. 5.

²³ *Pat.* 41 Edw. III, pt. ii, m. 11.

²⁴ *Devon, Issue Roll of Thomas de Brantingham*, 44 *Edw. III*, 101.

²⁵ E. A. Bond, 'Notices of the last days of Isabella Queen of Edward II,' *Arch.* xxxv, 461, 464. In acknowledgement of their attention, Isabella gave them a noble.

²⁶ Its income from tenements in London was £18 10s. 8d., from those in Hertfordshire £8 14s. (*Chan. Inq. Misc.* 41 Edw. III [2nd nos.], no. 40, file 192).

²⁷ *Lond. Epis. Reg. Braybrook*, fol. 389 d.; Sharpe, *Cal. Wills proved in Ct. of Husting, London*, i, 445, 460; 650, 697; ii, 20, 37, 41, 61, 152, 170, 185, 220, 225, 313, 341.

²⁸ Sharpe, *op. cit.* ii, 303.

²⁹ *Ibid.* 456.

³⁰ Sharpe, *op. cit.* ii, 450. By will dated June 1423 she left a tenement in the parish of St. Nicholas Cole Abbey to her daughter Joan for life, the remainder in trust for sale and part of the proceeds to Cheshunt Priory.

³¹ *Ibid.* 482. By will proved Oct. 1437 he bequeathed a tenement to his sister for life, with remainder to the Prioress and convent of Cheshunt.

³² Sharpe, *op. cit.* ii, 556.

³³ *Cal. Papal Letters*, iii, 472.

³⁴ *Lond. Epis. Reg. Braybrook*, fol. 312 d. The letters are undated.

³⁵ *Cal. Pat.* 1413-16, p. 374.

³⁶ *Ibid.* 1429-36, p. 78. ³⁷ *Ibid.* 1467-77, p. 188.

³⁸ *L. and P. Hen. VIII*, iv, 368. ³⁹ *Ibid.*

⁴⁰ Citation in Oct. 1520 by the auditor of the Papal Court of Cowper and the prioress (*ibid.* iii, 1026).

⁴¹ She said that Lovell being a great man refused to pay tithes (*L. and P. Hen. VIII*, iv, 368).

⁴² *Pat.* 28 Hen. VIII, pt. ii, m. 25. The indenture about the goods was made between the commissioners and Denny, not the prioress, on 28 May 1536 (K.R. Church Goods, 1²/₈).

A HISTORY OF HERTFORDSHIRE

The convent had by that time dwindled to four,⁴³ of whom the prioress, Margery Hill, received an annual pension of £5,⁴⁴ the other three nuns a small gift.

It is not unlikely that poverty prompted their early surrender. As the lead on the church was only worth £2,⁴⁵ it looks as if the building was in ruins.⁴⁶ The debts, too, were £8 9s. 8d.,⁴⁷ while the net income was only £13 10s.⁴⁸

PRIORESSES OF CHESHUNT

- Isabel,⁴⁹ occurs c. 1227-74
 Cassandra, occurs 30 September 1250⁵⁰
 Dionisia, occurs 1256-7⁵¹
 Alice⁵²
 Agnes⁵³
 Mary, occurs 20 February 1298⁵⁴
 Helen, resigned 1309⁵⁵
 Emma de Haddestoke, elected April 1309,
 but the election annulled⁵⁶
 Alice de Somery, occurs 24 August 1311⁵⁷ and
 28 May 1315⁵⁸

⁴³ Paid to three nuns and eight servants of the late priory of Cheshunt £4 19s. 4d. (Mins. Accts. Hen. VIII, no. 1606 [28 & 29 Hen. VIII]).

⁴⁴ *L. and P. Hen. VIII*, xiii (1), 1520. She was still receiving the pension in 1555 (Add. MS. 8102, m. 9).

⁴⁵ Mins. Accts. Hen. VIII, no. 1606. The two bells were priced at 60s. Goods and church ornaments were worth £51 18s. 4d. The inventory of the articles on 28 May 1536 in the church, hall, dormitory, maidens' chamber, priest's room, buttery, &c. . . . and of the store (K.R. Church Goods, $\frac{1}{3}$) is printed in Cussans, *Hist. of Herts. Hertford Hund.* 267, App. ii. The goods in the chancel, quire and belfry were reckoned at £8 7s. 2d., those in the dormitory, including most of the vestments, at £7 11s. 4d. The plate, valued then at £4 18s. 4d., a little later at £8 11s. 4d., consisted of two chalices, a salt with cover, a small cross and six spoons (Aug. Off. Misc. Bks. ccclxi, fol. 71).

⁴⁶ The house seems to have needed repairs in 1475 (will of Thomas Prowett, clerk, P.C.C. 23 Wattys).

⁴⁷ Transcript of Land Rev. Rec. bdle. 66, no. 3.

⁴⁸ *Valor Eccl.* (Rec. Com.), i, 452.

⁴⁹ She was prioress at the time of Humphrey de Bohun's grant, made between William de Mandeville's death in 1227 and his own in 1274. If the charter of Henry III to the nuns was a confirmation of the grant, Isabella must have been prioress c. 1227-40.

⁵⁰ Feet of F. 34 Hen. III, file 75, no. 1037.

⁵¹ Hardy and Page, *London and Middlesex Fines*, i, 37.

⁵² *Hist. MSS. Com. Rep.* ix, App. i, 26a.

⁵³ Predecessor of Mary (*Cal. Pat.* 1292-1301, p. 376).

⁵⁴ *Ibid.*

⁵⁵ *Reg. of Ralph Baldock* (Cant. and York Soc.), 106-7.

⁵⁶ *Ibid.*

⁵⁷ Anct. D. (P.R.O.), C 2433.

⁵⁸ *Cal. Pat.* 1313-17, p. 292.

Tiphania Chamberleyn, occurs May 1352,⁵⁹
 died c. 1382-1405⁶⁰

Agnes Amys, Tiphania's successor,⁶¹ occurs
 3 December 1415⁶²

Cecilia Gyffard, occurs 1 August 1451⁶³

Isabel Forest, occurs 8 February 1470⁶⁴

Isabel, occurs December 1474, 1475, 1476-
 82⁶⁵

Alice Clerk, occurs 1483-8⁶⁶

Margaret Chawry, occurs 30 September 1507,⁶⁷
 30 September 1511,⁶⁸ 1524⁶⁹ and 1532⁷⁰

Margery Hill, the last prioress⁷¹

The first seal is a pointed oval of the 12th century,⁷² showing the Virgin seated on a throne adorned with animals' heads and feet; the Child sits on her lap, and she holds a ball in either hand, that in her left having a lily issuing from it. Legend: . . . LLVM . C . . .

Another seal attached to a document of 1474⁷³ is a very small pointed oval, on which is shown the Virgin, crowned and enthroned, holding the Child on her right arm and in her left hand a sceptre.

7. ST. MARY DE PRÉ PRIORY, ST. ALBANS

The foundation of the nunnery of St. Mary de Pré in 1194 by Warin, Abbot of St. Albans, was the outcome of a vision. St. Amphibalus appeared in a dream to a man of Walden, and ordered him to tell the abbot to honour the place where the relics of himself and his companions on their way to the abbey had met the shrine of St. Alban,¹ for the spot was very dear to God and those martyrs.²

In obedience to this direction Warin built there a church dedicated to the Virgin Mary and houses for leprous women,³ who were to be veiled and live under a rule. The endow-

⁵⁹ *Cal. Papal Letters*, iii, 472.

⁶⁰ While Robert Braybrook was Bishop of London (Lond. Epis. Reg. Braybrook, fol. 312 d.).

⁶¹ *Ibid.*

⁶² *Cal. Pat.* 1413-16, p. 374.

⁶³ Sharpe, op. cit. ii, 556.

⁶⁴ *Cal. Pat.* 1467-77, p. 188.

⁶⁵ Harl. Chart. 44 C 2-10. Probably Isabel Forest.

⁶⁶ *Ibid.* 44 C 11-15, 18-25.

⁶⁷ Cart. Misc. (Aug. Off.), vol. vii, no. 11.

⁶⁸ Dugdale, *Mon.* iv, 330, no. iii.

⁶⁹ *L. and P. Hen. VIII*, iv, 368.

⁷⁰ *Ibid.* viii, 612.

⁷¹ *Ibid.* xiii (1), 1520.

⁷² B.M. Seals, lxiv, 61.

⁷³ Harl. Chart. 44 C 2.

¹ For the importance of this encounter see St. Albans.

² *Gesta Abbat.* i, 199-200.

³ *Ibid.* 201.

RELIGIOUS HOUSES

ment was made entirely at the abbey's expense,⁴ and was of a nature to keep the new priory very dependent on St. Albans. Warin gave to the house⁵ the site, church and buildings on both sides of the street and various tithes, including those of the abbey's demesne of Luton, of the new assart at Sarratt and all assarts made in future and of all pannage belonging to St. Albans; a rent of 20s. in Cambridge for the sisters' clothing⁶; and to each leper up to the number of thirteen a monk's left-off frock and cloak; for their maintenance the corrodies already given for past abbots, and one at the death of every abbot in future,⁷ until they numbered thirteen; the corrodies of Kings Offa and Henry and Pope Hadrian when the holders died, and meanwhile an allowance of bread, meat and ale from St. Albans; two loaves from every ovenful of the abbot's portion; leave to grind a measure of oats and another of malt at certain mills; 3d. a week from the toll of the town of St. Albans; food for two horses every day from the abbey granary; and a cart-load of wood every week; while the chaplain and his clerk were to receive their food daily from the abbey, a mark a year from Walden Church and half a mark from the church of Newnham.

The sisters were fortunate in their first warden, John de Walden, who was an able advocate of their cause, and as he enjoyed the royal favour it was probably through him that King John confirmed to them in 1199 2 acres in Eastbrook^{7a} given them by Queen Eleanor, and granted them a yearly fair on the vigil and feast of the Nativity of the Virgin⁸; in 1204 he further gave them 30 acres of assart in Eastbrook Wood⁹ and in 1215 received the house and sisters into his protection.¹⁰

A papal mandate of January 1223¹¹ forbade the abbot and convent to use their patronage to lay burdens on the lepers at Pré, but the actual grievance of the subject community is unfortunately not explained. According to Matthew Paris Pré was so poor in the middle of the 13th century that its inmates had scarcely

⁴ Matthew Paris is rather bitter on the subject (*Gesta Abbat.* i, 205).

⁵ *Ibid.* 202-4.

⁶ Land in Cambridge was granted by Warin to Anchtel de Grantebreg and his heirs for this rent to St. Mary de Pré (*Anct. D. [P.R.O.]*, A 11069).

⁷ The seventh was claimed and granted on the death of Abbot William de Trumpington in 1235 (*Gesta Abbat.* i, 305).

^{7a} Eastbrookhay in the parish of Hemel Hempstead (*V.C.H. Herts.* ii, 222).

⁸ *Cart. Antiq. M.* 20; *Inspex. of Ric. III* (*Dugdale, Mon.* iii, 358, no. viii).

⁹ *Cart. Antiq. M.* 18.

¹⁰ *Rot. Lit. Pat. (Rec. Com.)*, 131.

¹¹ *Cal. of Papal Letters*, i, 90. It was issued owing to a complaint of the lepers.

the necessities of life.¹² The exaction of the clerical tenth in 1254 must therefore have pressed hardly on them, especially since the house had just then to be rebuilt. It seems indeed that they could not have finished what they had begun if Pope Alexander IV had not helped them by offering indulgences to those who contributed to the work.¹³

Abbot Richard de Wallingford (1328-36) made a few regulations for the house.¹⁴ He required the brothers at their reception to swear fealty to St. Albans before the abbot and arch-deacon, and vow never to procure the entrance of brothers, sisters or nuns except through the abbot; they must also promise in writing to live in chastity, voluntary poverty and obedience according to the rule of St. Benedict. Up to this time it is said the brothers and sisters had professed no certain rule.

Some idea of the life led by the inmates may be gathered from the ordinances drawn up¹⁵ possibly by Abbot Michael or his successor Thomas de la Mare¹⁶ who is known to have made a rule for Pré.¹⁷

The master, who must be versed in temporal affairs, was to transact the business of the house with the advice of his brothers and the prioress and to render an account to the abbot every year; chapters were to be held twice a week by such brothers as were monks to treat of the needs of the house; when the bell was rung in the morning all were to rise, and after washing their hands go to church, where the brothers and chaplains were to say the matins of our Lady and of the day, then after a short interval the hours, and finally high mass, at which all unless very ill were to be present; the brothers were to have a common board, and the prioress, nuns and sisters were likewise to dine together in the frater, and none was to be late or leave before grace; from Easter to All Saints there were to be two meals a day, from All Saints to Lent one only, except on Sundays; intervals between mass and vespers were to be occupied with work or devotions in church; talking in church and after Compline was forbidden; the doors between the men and women were to be closed except at service-time; the brothers were not to speak to the nuns and sisters, and all were forbidden to talk to seculars where suspicion of evil might arise; no men must eat in the nuns' close without leave of the prioress;

¹² *Chron. Maj. (Rolls Ser.)*, v, 452.

¹³ *Dugdale, Mon.* iii, 356, no. iv, v, vi.

¹⁴ *Gesta Abbat.* ii, 213-14.

¹⁵ *Cott. MS. Nero, D 1*, fol. 173-4 d.

¹⁶ Both had personal reasons to be interested in Pré. Michael's sister Alice entered the hospital in 1342-3 (*Mins. Accts. bdle.* 869, no. 22), and Thomas's sister Dionisia became a nun there (*Gesta Abbat.* ii, 373).

¹⁷ *Gesta Abbat.* ii, 402.

A HISTORY OF HERTFORDSHIRE

visitors were to be kindly received, men by the brothers, women by the nuns and sisters, who must never allow secular persons to eat in the private rooms, such as the dormitory; the prioress was to see that the nuns slept in their beds in one house and the sisters in another; no brother or sister must go out of the house to roam about¹⁸ or talk to friends or enter a town without leave of the master and consent of the archdeacon; obedience to the master was enjoined on the brothers and obedience to the prioress on the sisters and nuns.

The division of the inmates into nuns and sisters holding an inferior position seems not to have been contemplated by Abbot Warin, who intended the house apparently for thirteen sisters, but the mention of a prioress in 1255 proves that the two classes existed soon after the foundation.¹⁹ Of the proportion of sisters to nuns there is no information, but in 1341-2 there were four sisters,²⁰ in 1342-3 five,²¹ and in 1352-3 eight nuns besides the prioress.²² As leprosy died out and the house became less of a hospital,²³ the distinction was found unsatisfactory, and Abbot Thomas de la Mare (1349-96) provided that no more sisters were to be received and those there then might become nuns if they wished.²⁴ At the same time he insisted on a higher standard of education. Most of the nuns were so unlettered that they could only repeat one or two prayers,²⁵ but the abbot now required them to learn the service and say it daily, and because they had no books gave them some from St. Albans.²⁶ In the interests of discipline he ordained also that all entering the house in future must profess the rule of St. Benedict in writing and take the vows before the Archdeacon of St. Albans.²⁷ He did not forget their temporal welfare, but had what was due to them from the monastery noted in a register to prevent its withdrawal at any time.²⁸

¹⁸ The passage is headed 'Le defence de passir hors de la porte en perigrinage alir.'

¹⁹ W. Page, 'The Hist. of Mon. of St. Mary de Pré, St. Albans and Herts. Archit. and Arch. Soc. Trans. (New Ser.), i, 12.

²⁰ Mins. Accts. bdl. 867, no. 21.

²¹ Ibid. no. 22.

²² Ibid. no. 25.

²³ In the 13th century it was generally called a hospital, and represented officially by the master (Feet of F. Herts. 32 Hen. III, no. 344; 7 Edw. I, no. 97; Lay Subs. R. 19 & 24 Edw. I, bdl. 120, no. 2 and 5). In one instance the prioress and nuns figure with the master and brothers (Add. Chart. 19279).

²⁴ *Gesta Abbat.* ii, 401.

²⁵ They said the Lord's Prayer and the 'Hail Mary' instead of the service.

²⁶ *Gesta Abbat.* ii, 402.

²⁷ Ibid.

²⁸ Ibid. 401.

The accounts of the wardens 1341-57²⁹ provide much information as to buildings,³⁰ food³¹ and domestic economy generally. Among the receipts are one or two interesting items: 40s. paid at the entrance of the abbot's sister in 1342-3; 15s. 3d. paid to Sister Isabella Ruthersfeld for her ale³² in 1350-1; £10 received from John Kyrkely on becoming a brother of the house in 1352-3.³³ Every expense is noted, the lock for the larder, thread and pack-needles, wax and cotton for candles and payment to a man making them, the stipend of a brewer for four days and payment to a barber. The servants in 1350-1 numbered fifteen and comprised three *tenatores*, apparently farmers, a huntsman, cowherd, shepherd, swineherd, four ploughmen, a maidservant of the kitchen, the nuns' maid, the master's servant, and a man collecting bread and ale for the nuns at St. Albans. The income in 1341-2 was about £55, the expenses £46; both were much the same in 1342-3; in 1350-1 the receipts were £63 13s. 5½d., expenses £75 3s. 9½d., but in 1352-3 the balance was £15 on the right side; so on the whole the management must have been good.³⁴

Early in the 15th century the nuns received an important addition to their property, Henry V in 1416 granting them the reversion, after the death of Queen Joan, of the alien priory of Wing, co. Bucks.³⁵ He also exempted the estate from payment of all subsidies, though owing to an omission in the wording of the grant the convent's claim in this respect was not acknowledged until 1440.³⁶ On the accession of Edward IV the convent obtained a fresh patent, which mentioned the parish church and its advowson as well as the manor.³⁷

²⁹ Mins. Accts. bdl. 867, no. 21-6.

³⁰ Besides the church there is mention of the hall, almshouse and bakehouse, all tiled, the chamber of the brothers, that of the nuns and sisters, the refectory, laundry-house and cowhouse outside the gates.

³¹ Their purchases included salt for the larder and white salt for the household, spice, meat, olive oil, milk, cheese, butter and eggs; in 1350-1 100 fish, called Middelwoxfisch; in 1356-7 1,000 herrings, 2 salmon for 4s., 6 salt fish 8s.; on feast of Nativity of B. V. Mary ox-meat 3s. and 4 geese 20d. In 1352-3 at each of the six principal feasts the nuns received 60 flagons of ale, and a memorandum was made that they ought to have 100 flagons (ibid. no. 25).

³² Ibid. no. 23.

³³ Ibid. no. 25. He was warden of the house in 1356 (ibid. no. 26).

³⁴ Ibid. *passim*.

³⁵ *Cal. Pat.* 1416-22, p. 38. It was in his hands in 1420, and he then gave them the issues (ibid. p. 276).

³⁶ Ibid. 1436-41, p. 469.

³⁷ Ibid. 1461-7, p. 53. It cost the convent £9 17s. 6d. (Mins. Accts. bdl. 867, no. 30).

RELIGIOUS HOUSES

From 1461 to 1493 the accounts of the house,³⁸ now kept by the prioress, again supply many details about its administration.³⁹ There were then nine or ten nuns besides the prioress, and the expenses were usually kept within the limits of an income of about £65. The house financially seems generally to have been well ordered.

Of its condition in other respects nothing is known⁴⁰ except from the letter of Archbishop Morton to the Abbot of St. Albans in July 1490.⁴¹ Morton had heard on good authority, he said, that Helen Germyn, the prioress, was a married woman who had left her husband for a lover, and that she and others of the convent were leading notoriously immoral lives with some of the monks of St. Albans. There was enough truth in the report to cause Helen's removal,⁴² and apparently the selection of the next prioress from Sopwell.⁴³

Beyond the accounts of the prioress in 1515⁴⁴ and in 1526-7⁴⁵ there is no further information about Pré until April 1528, when it was found on an inquiry⁴⁶ that the last prioress, Eleanor Barnarde, had died in the previous June, and

³⁸ Mins. Accts. bdle. 867, no. 30, 32, 33-6; Hen. VII, no. 274.

³⁹ The nuns had 10d. a week for board, and pittances on feasts of St. Nicholas, St. Leonard, the Circumcision, Epiphany, St. Mary Magdalene, and Nativity of B. V. Mary, 16 December and the anniversary of Henry V. On the Nativity of the Virgin Mary, the fairtime, over £1 was spent on the convent and visitors. Payments for wassail at New Year and Twelfth Night, harpers and players at Christmas, for May games, for bread and ale on bonfire nights, and for coals in the dormitory show that the nuns had amusements and even luxuries. A good deal of hospitality was shown to tenants, strangers and the poor, and rooms were let in the precinct, so that the convent was by no means cut off from the world. The accounts of 1490-3 (Mins. Accts. Hen. VII, no. 274.) include payments for cutting the vine, mowing the convent garden, shaking the fruit trees there, gathering palm and flowers for Palm Sunday, cartage of herrings and sprats from London, and cleaning the great kitchen and guest-chamber, and making trestles and forms in connexion with the fair.

⁴⁰ A certain Joan Sturmyn had so much confidence in Alice Wafer, prioress 1480-5, that she entrusted to her keeping goods worth £50. It is clear, too, that though the goods were afterwards detained from Joan's executors, Alice was not to blame (Early Chan. Proc. bdle. 97, no. 6).

⁴¹ Wilkins, *Concilia*, iii, 632.

⁴² The accounts of the house (Mins. Accts. Hen. VII, no. 275) show that shortly before Michaelmas 1490 Amy Goden had succeeded Helen, here called Kydyer, who must therefore have been removed, unless by a coincidence she had died.

⁴³ In 1465 there was at Sopwell a nun called Amy Godyn (Anct. D. [P.R.O.], A 2491), the name of Helen's successor.

⁴⁴ *L. and P. Hen. VIII*, ii, 959.

⁴⁵ Aug. Off. Misc. Bks. cclxxii, fol. 79.

⁴⁶ Cardinal's Bdles. i.

that the three nuns composing the convent had deserted the place. It had apparently been represented to Pope Clement VII before that regular discipline was much relaxed and the nuns did not live as good lives as they ought; for it was on this ground that in May 1528 he dissolved the priory and annexed it to the abbey of St. Albans, then held by Cardinal Wolsey *in commendam*.⁴⁷ In July Henry VIII granted the site of the late nunnery with all its possessions to Wolsey himself,⁴⁸ who conferred it on his new college at Oxford.⁴⁹ Its property comprised⁵⁰ the manors of Pré, 'Playdell'⁵¹ and Beaumonts, rent in lieu of tithes in Redbourn, Sarratt, Codicote (co. Herts.) and Dallow⁵² (in Luton, co. Bedford), and various parcels of land, the manor of Wing with the advowson of the church and the rectory and the manor of Swanbourne (co. Bucks.), in which place the nuns had a holding in 1252.⁵³

WARDENS OR MASTERS OF ST. MARY DE PRÉ PRIORY

John de Walden, the first master⁵⁴
 Richard, occurs 1235⁵⁵
 William, occurs 1248⁵⁶
 Richard, occurs 1278⁵⁷
 Roger, occurs c. 1316⁵⁸
 John le Patere, occurs March 1325⁵⁹
 Richard de Bovyndon, occurs September 1341
 to September 1342⁶⁰
 Nicholas Redhod, occurs March 1352 to
 March 1353⁶¹
 John de Kyrkely, occurs 13 August 1356 to
 25 March 1357⁶²

PRIORESSES OF ST. MARY DE PRÉ PRIORY

— de la Moote, occurs 1401⁶³
 Lucy Botelere (?), occurs 1430⁶⁴

⁴⁷ Dugdale, *Mon.* iii, 361, no. xi.

⁴⁸ *L. and P. Hen. VIII*, iv, 4472.

⁴⁹ *Ibid.* 5714, 5786. ⁵⁰ *Ibid.* 4472.

⁵¹ In 1350-1 they kept a *tenator* and a huntsman here (Mins. Accts. bdle. 867, no. 24).

⁵² They had property here in 1350-1 (*ibid.* no. 23).

⁵³ *Cal. Pat.* 1247-58, p. 139.

⁵⁴ *Gesta Abbat.* i, 201. ⁵⁵ *Ibid.* 305.

⁵⁶ Feet of F. Herts. 32 Hen. III, no. 344.

⁵⁷ *Ibid.* 7 Edw. I, no. 97.

⁵⁸ Rentals and Surv. portf. 8, no. 38.

⁵⁹ Lansd. MS. 375, fol. 95 d.-96.

⁶⁰ Mins. Accts. bdle. 867, no. 21.

⁶¹ *Ibid.* no. 25. ⁶² *Ibid.* no. 26.

⁶³ The sister of John de la Moote, Abbot of St. Albans, who when dying asked the convent to restore to her £40 which had been used for the monastery, or provide for her otherwise, such as by a livery (*Gesta Abbat.* iii, 452).

⁶⁴ She is not called prioress, but as she is the only one named among several nuns then received into the fraternity of St. Albans (Amundesham, *Annales*, i, 51), it is probable that she was the head.

A HISTORY OF HERTFORDSHIRE

Isabella Benyngton, occurs 1446⁶⁵; Isabella, occurs 1460-1⁶⁶
Isabella or Elizabeth Baron,⁶⁷ occurs September 1468-71,⁶⁸ retired 4 April 1480⁶⁹
Alice Wafer, appointed April 1480,⁷⁰ occurs 1482-5⁷¹
Christiana Basset, occurs March 1487 to December 1488⁷²
Helen Germyne, occurs July 1490⁷³
Amy Goden, occurs 29 September 1490-3⁷⁴
Margaret Vernon, occurs 29 September 1513-15⁷⁵
Eleanor Barnard, the last prioress, died 4 June 1527⁷⁶

The seal of the house attached to a 13th-century charter⁷⁷ is a pointed oval. On it is represented a three-quarter length figure of the Virgin, crowned and enthroned, with a sceptre in her right hand; she holds on her left knee the Child, who has a cruciform nimbus. At the sides are two lily branches. Below, under the words AVE MARIA, which the cutter has reversed, is a leper-woman praying, and behind her a star. The only letters remaining of the legend are: s' . . . e . . . to.

8. ST. GILES IN THE WOOD PRIORY, FLAMSTEAD

About the middle of the 12th century Roger de Todeu or Tony¹ founded at Flamstead a priory in honour of St. Giles for Benedictine nuns and endowed it with land and certain small tithes in the parish.² He ordained that the assent of himself and of his heirs must be obtained at the election of the prioress, and that without their consent there should never be more than thirteen nuns in the house.

The priory, to which a pension of 5 marks out

⁶⁵ Dugdale, *Mon.* iii, 357.

⁶⁶ Mins. Accts. bdle. 867, no. 30. Possibly Isabella Baron.

⁶⁷ She is in the Book of Benefactors of St. Albans, as giving 2 marks for the ornaments of the church and decoration of various altars (Cott. MS. Nero, vii, fol. 115).

⁶⁸ Mins. Accts. bdle. 867, no. 32, 33.

⁶⁹ *Reg. of St. Albans*, ii, 209. She died in 1491 (Mins. Accts. Hen. VII, no. 275).

⁷⁰ *Reg. of St. Albans*, ii, 209.

⁷¹ Mins. Accts. bdle. 867, no. 35-6. She either resigned or was removed, for she was living at Pré in 1487-8. ⁷² Mins. Accts. Hen. VII, no. 274.

⁷³ Wilkins, *Concilia*, iii, 632.

⁷⁴ Mins. Accts. Hen. VII, no. 275.

⁷⁵ *L. and P. Hen. VIII*, ii, 959.

⁷⁶ Cardinal's Bdles. i. ⁷⁷ Add. Chart. 19279.

¹ This family held Flamstead from the time of the Domesday Survey until the 14th century (*V.C.H. Herts.* ii, 194).

² Dugdale, *Mon.* iv, 299, no. i. This is evidently the charter shown by the prioress at a visitation in 1530.

of Dallington rectory was assigned in 1220,³ received from Agatha de Gatesden in 1228 some land in Hemel Hempstead⁴ and acquired before 1244⁵ land and 30s. rent in Edlesborough (co. Bucks.) from Nicholas son of Bernard, whose granddaughter Isabella afterwards sold to the nuns all that she owned in that place⁶; property in Potsgrove (co. Bedford) was made over in 1257 to the convent,⁷ who in 1270 held 20 virgates of land in Wingrave given to them by William de la Hyde.⁸

The statute of Pope Boniface VIII for the stricter cloistering of nuns, obedience to which was enjoined upon them in 1300,⁹ added restrictions to a life already sufficiently hard, for there is no doubt that the nuns were very poor. William Dalderby, Bishop of Lincoln, in appointing delegates in July 1308 to examine a recent election at St. Giles's, commissioned them to act for him in choosing a prioress if necessary, evidently from a desire to save the nuns expense,¹⁰ and on 17 June 1316¹¹ he granted an indulgence of thirty days to all who gave alms to the priory.

Careful administration was of paramount importance, and it was at the earnest supplication of the prioress and convent that the Bishop of Lincoln on 17 March 1336-7 appointed as master of the house a priest called Roger de Croule, of whose prudence and industry he was assured.¹²

Pestilence with its agricultural consequences must have aggravated the nuns' difficulties¹³ in the latter part of the 14th century. The petition of the convent to Pope Urban VI¹⁴

³ Bridges, *Hist. of Northants*, i, 494.

⁴ Dugdale, *Mon.* iv, 300, no. ii.

⁵ In that year Margery widow of Nicholas renounced her claims in dower in return for a life grant of a messuage, a mark of silver, 3½ qrs. of wheat and 12 cartloads of wood a year (Feet of F. Bucks. 28 Hen. III, no. 47).

⁶ Dugdale, *Mon.* iv, 301, no. iii. Confirmation by Henry III in 1267-8.

⁷ Feet of F. Bucks. 40 & 41 Hen. III, no. 147.

⁸ *Ibid.* 55 Hen. III, no. 134. William was the grandfather of the tenant of 1270.

⁹ Linc. Epis. Reg. Dalderby, Memo. fol. 10 d.

¹⁰ *Ibid.* fol. 112 d.

¹¹ *Ibid.* fol. 327.

¹² *Ibid.* Burghersh, Memo. fol. 355 d. On the same day he gave them as confessor a Dominican friar.

¹³ The extreme poverty of the house may have been the reason why Helen Lovell, a novice there, decided in 1352 not to take vows (*ibid.* Gynwell, Memo. fol. 7).

¹⁴ If, as Dugdale says, the bull to the Bishop of Lincoln for inquiry was issued by Pope Urban IV (*Mon.* iv, 301), its date must be March 1263, and in this case the nuns over a century later presented a petition containing precisely the same details (Linc. Epis. Reg. Buckingham, Memo. pt. ii, fol. 232 d.). But it seems most unlikely that history repeated itself so exactly, and the bull should probably be dated March, the second year of Urban VI, i.e., 1380.

RELIGIOUS HOUSES

begging that the church of Dallington might be appropriated to them¹⁵ represents that their original endowment had been so slender and the place of foundation was so sterile that the rents did not exceed 15 marks a year, and each nun was allowed only 2s. a year for her clothing and ½d. a week for food; so many of the people serving the priory had died, and the houses were in such a bad state and the live stock so diminished, that the conventual lands were left uncultivated, and unless some remedy were provided the nuns would have to beg the necessities of life from door to door. The Bishop of Lincoln vouched for the truth of these statements, and the pope gave the necessary licence in August 1381,¹⁶ a vicarage at Dallington being ordained a few months later.¹⁷ Beyond one or two notices of the election of a prioress and the commission of Bishop Grey for a visitation¹⁸ nothing is heard of the priory during the 15th century.

When the chancellor of the diocese on behalf of Bishop Longland visited Flamstead in May 1530¹⁹ there were seven nuns²⁰ besides the prioress. Three of them said that all was well, another reported that young girls were allowed to sleep in the dormitory, and another that the prioress had a nun to sleep with her, apparently because she was afraid of being late for matins. The prioress was enjoined to give up this practice and to exclude children of both sexes from the dormitory. From the second injunction it may be inferred that the nuns kept a school. The priory came to an end on 3 March 1537²¹ under the Act of the previous year dissolving monasteries of less than £200 annual value. The conduct of the nuns was irreproachable, the commissioners returning them as 'of very good report,'²² and the management of the place had evidently been efficient, since the house was in good repair.

Agnes Croke, the prioress, received a pension of £6 a year,²³ but the seven other nuns seem to have been dismissed with a small sum of money.²⁴

The income of the priory was estimated in 1526 at £39 6s. 8d. gross and £17 17s. 6d. net,²⁵ in

1535 at £30 19s. 6½d. clear²⁶ and in 1537 at £37 net²⁷; it was derived from the manor of Woodhall in Hemel Hempstead, land and rents in Flamstead, Gaddesden and St. Albans (co. Herts.), in Studham and Hockliffe (co. Beds.), Cholesbury, Dagnall, Edlesborough and Wingrave (co. Bucks.), and the rectories of Tilsworth (co. Beds.) and Dallington (co. Northants).²⁸ The goods and chattels of the nunnery with the ornaments of the church were sold for £44 8s. 3½d.²⁹; the plate was valued at £6 4s. 7½d.³⁰ and the three bells at £10.³¹

PRIORESSES OF ST. GILES, FLAMSTEAD

Agnes, occurs June 1244,³² died 1254-5³³
Petronilla de Lucy, elected 1254-5,³⁴ occurs 1256³⁵

Loretta, occurs 1270³⁶

Laura, died 1291³⁷

Joan de Whethamsted, elected 1291³⁸

Cecilia de Mortheyn, elected July 1308,³⁹ resigned 1316⁴⁰

Helen de Dunstaple, elected 1316⁴¹

Maud Lucy, elected 1415⁴²

Joan Mourton, died 1454⁴³

Catherine Colyngryge, elected 1454⁴⁴

Joan Bone, occurs 12 March 1498-9⁴⁵

Agnes Tryng, elected 1509,⁴⁶ occurs 1510 and 1514,⁴⁷ resigned 1517⁴⁸

²⁶ *Valor Eccl.* (Rec. Com.), iv, 276.

²⁷ Transcript of Land Rev. Rec. bdle. 66, no. 3.

²⁸ Rentals and Surv. (Gen. Ser.), portf. 8, no. 41; Mins. Accts. Hen. VIII, no. 1606.

²⁹ Counting the wheat sown in the demesne lands, which sold for £15. The stuff in the parlour fetched 5s., that of the quire 6s. 8d., of the vestry 66s. 8d., of the kitchen 15s., of the high chamber 30s., of the middle chamber 36s. 4d., of the buttery 20s. and of the bakehouse 26s. 8d., a table of alabaster 20s., another for our Lady altar 3s. 4d., the glass in the church windows 20s., the timber in the quire 26s. 8d. The nuns had 6 horses, 7 kine and 2 heifers, 7 swine and 28 sheep (Aug. Off. Misc. Bks. ccclxi, fol. 65).

³⁰ *Ibid.* It consisted of a silver salt, six silver spoons, a chalice and paten gilt, and 'the garnishing of a mazer band.'

³¹ Mins. Accts. Hen. VIII, no. 1606.

³² Feet of F. Bucks. 28 Hen. III, no. 47.

³³ Linc. Epis. Reg. Lexington's Rolls (Huntingdon Archd. Anno, 2).³⁴ *Ibid.*

³⁵ Feet of F. Bucks. 40 Hen. III, no. 147.

³⁶ *Ibid.* 55 Hen. III, no. 134.

³⁷ Linc. Epis. Reg. Sutton, Inst. fol. 85 d. She is mentioned in the Lay Subsidy Roll of 1290-1 (bdle. 120, no. 2).

³⁸ Linc. Epis. Reg. Sutton, Inst. fol. 85 d.

³⁹ *Ibid.* Daldery, Memo. fol. 112 d.

⁴⁰ *Ibid.* fol. 327.

⁴¹ *Ibid.*

⁴² *Ibid.* Repingdon, Inst. fol. 361 d.

⁴³ *Ibid.* Chedworth, Inst. fol. 186.⁴⁴ *Ibid.*

⁴⁵ Aug. Off. Convent. Leases, iv, no. 118.

⁴⁶ Linc. Epis. Reg. Smith, Inst. fol. 423.

⁴⁷ Aug. Off. Convent. Leases, iv, no. 116, 120.

⁴⁸ Linc. Epis. Reg. Wolsey and Atwater, Inst. fol. 47.

¹⁵ They obtained the king's permission in 1313 (*Cal. Pat.* 1307-13, p. 591).

¹⁶ Linc. Epis. Reg. Buckingham, Memo. pt. ii, fol. 232 d.¹⁷ Apr. 1382 (*ibid.* fol. 233).

¹⁸ *Ibid.* Grey, Memo. (1431-5), fol. 89.

¹⁹ Doc. of Bp. of Lincoln at Exchequer Gate.

²⁰ Five 'ladies' and two sisters.

²¹ *L. and P. Hen. VIII*, xii (1), 571 (3).

²² Transcript of Land Rev. Rec. bdle. 66, no. 3.

²³ *L. and P. Hen. VIII*, xiii (1), p. 577. She was still receiving it in 1555 (Add. MS. 8102, m. 9).

²⁴ The sum of £16 12s. 10d. was divided among the seven nuns and ten servants (Mins. Accts. Hen. VIII, no. 1606).

²⁵ Salter, *A subsidy collected in the diocese of Lincoln in 1526*, p. 193.

A HISTORY OF HERTFORDSHIRE

Agnes Croke, elected 1517,⁴⁹ occurs 1530,⁵⁰ and at the dissolution of the house, March 1537⁵¹

9. ROWNEY PRIORY, GREAT MUNDEN

A small priory for Benedictine nuns was founded in honour of St. John Baptist c. 1164¹ by Conan Duke of Brittany and Earl of Richmond, at Rowney in the parish of Great Munden, and endowed by him and later owners of property in the neighbourhood with tenements there of the annual value of 10 marks.² Among these benefactors were Richard son of Gilbert de Munden, John son of William de Munden, Stephen, Andrew and Richard de Scales,³ Richard and Gerard de Furnival,⁴ Guy Delaville and Reginald de Tanet,⁵ the grant of the last in 'Chelsea,'⁶ with that of Stephen de Scales in Munden receiving the confirmation of Pope Alexander.⁷ The lords of the manor of Great Munden were as such patrons of Rowney,⁸ which meant that at the election of a prioress their consent had to be obtained.⁹

It has been said that during the 14th century the priory was comparatively wealthy,¹⁰ but for this idea there seems little or no ground. The advowson of the priory in 1302 was worth nothing, because of the poverty of the house,¹¹ the regular income of which according to a

rental of c. 1336-7 was £7 1s. 4½d.,¹² and there is no proof that the convent received any considerable gifts afterwards.

Luke, rector of Throcking, was made master of the nunnery in March 1302,¹³ Richard Punchard of Willian chaplain in 1318 at the request of the prioress,¹⁴ while in February 1327-8 the administration of the house was committed to Ralph, rector of Great Munden.¹⁵ John Prior of Wymondley in 1302 was appointed confessor to the nuns.¹⁶ One of the convent in December 1350 received a papal indult to choose a confessor who might give her plenary remission at the hour of death.¹⁷

Out of the scanty information extant about Rowney a large proportion is discreditable to the nuns. From the Court Rolls of Munden Furnival in 1375¹⁸ it appears that the prioress had then been guilty of a hand-to-hand scuffle with a chaplain called Alexander of Great Munden, each being fined for drawing blood from the other, and the lady having also to pay for raising hue and cry unjustly on her opponent.

An order was issued in 1401 for the arrest of one of the nuns, Joan Adilesley, who was wandering about in secular dress¹⁹; and a visitation of the house in 1418²⁰ was followed by the deprivation of the prioress, Catherine Grenefeld.²¹

It is perhaps unfair to form an opinion from isolated cases separated by such long intervals of time, yet the suspicion is unavoidable that the place was not altogether what it ought to have been. It should, however, be remembered that life at Rowney may have been very hard. The revenues, always small and certainly not increased after the Black Death, could have supplied only the barest necessities. Early in the 15th century the chalices, books and ornaments were stolen by robbers, and the nuns were left without the means of performing the divine offices. On this occasion the Bishop of Ely helped the convent by offering an indulgence in 1408 to those who assisted them.²²

The nuns on one occasion petitioned the chancellor,²³ saying that their church and other buildings were likely to fall down for lack of

⁴⁹ Linc. Epis. Reg. Wolsey and Atwater, Inst. fol. 47.

⁵⁰ Doc. of Bp. of Lincoln at Exchequer Gate, Visit. of Bp. Longland. She also occurs several times between March 1521 and June 1534 (Aug. Off. Convent. Leases, iv, no. 114, 115, 119, 120-30, 133, 134).

⁵¹ Mins. Accts. Hen. VIII, no. 1606.

¹ Dugdale, *Mon.* iv, 342.

² Pat. 37 Hen. VI, pt. i, m. 15, printed in Dugdale, *Mon.* iv, 343. The wording of the document implies that the benefactors therein mentioned were owners of the lordship of Munden, but apparently this was not true of all.

³ Stephen de Scales, who lived in the time of Henry II, and Richard, who died 1230, held the manor of Little Munden; Andrew de Scales was instituted rector of that place in 1219 (Cussans, *Hist. of Herts. Broadwater Hund.* 148, 155).

⁴ Two of this name were owners of Great Munden, the second dying in 1219 (Chauncy, *Hist. Antiq. of Herts.* 341).

⁵ Perhaps Reginald de Tany, who occurs in the reign of Henry II (*Red Bk. of Exch.* [Rolls Ser.], 346, 379).

⁶ Possibly Chelsing in Bengeo, not far from Rowney.

⁷ Dugdale, *Mon.* iv, 344, no. iii. In all probability Pope Alexander III, 1159-81.

⁸ Feet of F. Herts. 13 Edw. I, no. 157; 32 Edw. I, no. 388; 26 Hen. VI, no. 138.

⁹ Linc. Epis. Reg. Lexington Rolls (Huntingdon Archd. anno 4).

¹⁰ Cussans, op. cit. *Broadwater Hund.* 140.

¹¹ Chan. Inq. p.m. 30 Edw. I, no. 31.

¹² Rentals and Surv. R. 293.

¹³ Linc. Epis. Reg. Dalderby, Memo. fol. 44.

¹⁴ Ibid. fol. 366.

¹⁵ Ibid. Burghersh, Memo. fol. 176.

¹⁶ Ibid. Dalderby, Memo. fol. 44.

¹⁷ *Cal. of Papal Letters*, iii, 372.

¹⁸ Ct. R. (Gen. Ser.), portf. 178, no. 9, m. 6 d.

¹⁹ *Cal. Pat.* 1399-1401, p. 418. The prioress notified Joan's apostasy to the secular authorities 12 Nov. 1400 and again in March 1401 (Chancery Warrants [Ser. 1], file 1759, no. 29, 30).

²⁰ The bishop's commission was issued on 12 June (Linc. Epis. Reg. Repingdon, Memo. fol. 176).

²¹ Ibid. fol. 185.

²² Gibbons, *Cal. Ely Epis. Rec.* 406.

²³ Anct. Pet. (P.R.O.), no. 15063.



WYMONDLEY PRIORY
(14th century).



ROWNEY PRIORY
(13th century).



FRIARS MINORS OF WARE
(14th century).



JOHN, PRIOR OF WARE
(1260).



KING'S LANGLEY PRIORY
(15th century).



ROBERT, PRIOR OF REDBOURN
(14th century).



HODDESDON HOSPITAL
(15th century).



HODDESDON HOSPITAL
(15th century).

RELIGIOUS HOUSES

repairs, which they had no money to do, and begging him to grant them a patent for a proctor to go about the country to collect alms on their behalf. The convent at some time must have received such a licence, for a letter dated August 1431 authorizes a proctor²⁴ to solicit for them the charity of the faithful, since through misfortune they had come to such want that they could not live on their own resources.

They seem to have suffered, too, from the encroachments of unscrupulous neighbours. Margaret Lyle, the prioress, complained to the chancellor, c. 1431-43,²⁵ that one Thomas Howard had deprived them for years of Langhoe Wood, in Great Munden, which had long been theirs, and owing to a technical flaw in her evidence and her fear of him she had no remedy in common law.

The nuns in 1448²⁶ found it difficult even to pay for a chaplain, and begged the king that they might have as priest John Tyvnham, an old Franciscan, who preached well and was of good reputation, because unless they had a young man, and that was not fitting, they were asked a larger salary than they could afford.

The continuance of a community there was at length found impossible. Through the neglect and bad management of the prioress, it was said, the property had so diminished that it was insufficient to maintain any nuns, support the necessary charges and rebuild the church and house, then in ruins.²⁷ The prioress and convent, therefore, on 11 September 1457 made over the place with all its possessions to John Fray, chief baron of the Exchequer,²⁸ who ten years before had bought the manor of Great Munden and the advowson of the priory.²⁹

Fray, unwilling that the religious services should lapse, established in the priory church and endowed with the conventual property a perpetual chantry of one chaplain to celebrate for the good estate of the king and himself, and for the souls of the founder and benefactors of the late nunnery.³⁰ The convent c. 1336 had land in Great and Little Munden, Standon,³¹ West-

mill,³² Alswick in Layston, Sandon, Wyddial and Welwyn.³³ The net annual value of the chantry's property was estimated in 1535 at £13 10s. 9d.³⁴ and in 1548 at £18 15s. 1d.³⁵

PRIORESSES OF ROWNEY

- Rose, resigned 1256-7³⁶
- Nicholaa, elected 1256-7³⁷
- Agnes de London, resigned August 1291³⁸
- Alice de Chingford, elected 1291,³⁹ died 1318⁴⁰
- Joan de London, elected 1318⁴¹
- Joan Spenser, elected December 1327⁴²
- Joan de London, occurs 1338 (?)⁴³
- Margaret Costance, died 1371⁴⁴
- Catherine de Hemsted, elected 1371⁴⁵ ;
Catherine occurs 1397 and 1399⁴⁶
- Catherine Grenefeld, removed 1418⁴⁷
- Alice Lyle (?)⁴⁸
- Margaret Lyle, occurs c. 1431-43,⁴⁹ resigned or died before February 1449⁵⁰
- Elizabeth Brandon, appointed 16 January 1450,⁵¹ resigned 20 May 1455⁵²
- Agnes Selby, surrendered the priory October 1457⁵³

The circular seal attached to a 13th-century charter⁵⁴ in the British Museum shows a right hand between two sprays of conventional foliage issuing from the base of the design supporting a dish on which lies the head of St. John Baptist. The legend is: SIGILL' DVENT . SCIMONIALIV DE RVGNH'

³² They had land here in the 13th century (Anct. D. [P.R.O.], C 2035).

³³ Rentals and Surv. R. 293.

³⁴ *Valor Eccl.* (Rec. Com.), iv, 278.

³⁵ Including 6s. 8d., the farm of the priest's lodging (Chant. Cert. 27, no. 7).

³⁶ Linc. Epis. Reg. Lexington Rolls (Huntingdon Archd. Anno 4).

³⁷ *Ibid.* ³⁸ *Ibid.* Sutton, Inst. fol. 85 d.

³⁹ *Ibid.* ⁴⁰ *Ibid.* Dalderby, Inst. fol. 253.

⁴¹ *Ibid.* ⁴² *Ibid.* Burghersh, Memo. fol. 174.

⁴³ Confirmation 10 Sept. 1338 of a lease by her (*Cal. Pat.* 1338-40, p. 154).

⁴⁴ Linc. Epis. Reg. Buckingham, Inst. fol. 301.

⁴⁵ *Ibid.*

⁴⁶ Ct. R. (Gen. Ser.), portf. 178, no. 11. She may have been Catherine Grenefeld.

⁴⁷ Linc. Epis. Reg. Repingdon, Memo. fol. 185.

⁴⁸ In 1466 there is mention of a lease granted by Alice Lyle, late Prioress of Rowney, but nothing is known of the date of the deed except that it was previous to July 1454 (Ct. R. [Gen. Ser.], portf. 178, no. 16).

⁴⁹ Early Chan. Proc. bdl. 11, no. 308.

⁵⁰ *Acts of P.C.* 1443-60, p. 67.

⁵¹ Cant. Archiepis. Reg. Stafford, fol. 33. The nuns omitted to elect within the proper time, so the Archbishop of Canterbury appointed, the see of Lincoln being vacant.

⁵² On becoming Prioress of Hinchinbrook (Add. Chart. 33621). ⁵³ Dugdale, *Mon.* iv, 343, no. i.

⁵⁴ B.M. Chart. L. F. C. iv, 2.

²⁴ Cart. Misc. (Aug. Off.), vol. xxi, no. 196. The proctor's name is represented by the letters A. B.

²⁵ Early Chan. Proc. bdl. 11, no. 308.

²⁶ The answer was given 28 Feb. 1449 (*Acts of P.C.* 1443-60, p. 67).

²⁷ Pat. 37 Hen. VI, pt. i, m. 15, printed in Dugdale, *Mon.* iv, 343, no. ii.

²⁸ Dugdale, *Mon.* iv, 343, no. i. Ill-luck dogged the nuns to the end. An order was given on 24 Oct. 1457 for the arrest of John Vale *alias* Parys to answer concerning riots and offences done to Agnes Prioress of Rowney (*Cal. Pat.* 1452-66, p. 402).

²⁹ Feet of F. Herts. 26 Hen. VI, no. 138.

³⁰ Dugdale, *Mon.* iv, 343, no. ii.

³¹ They received 8 acres here in exchange for land in Little Munden from William de Munden in 1339 (*Cal. Pat.* 1338-40, p. 242).

HOUSES OF AUSTIN CANONS

10. ROYSTON PRIORY

The priory of St. John Baptist and St. Thomas the Martyr of Royston seems to have originated in a chapel built by Eustace de Merk in his fee of Newsells for three chaplains; this was enlarged or rebuilt at his request by his nephew Ralph de Rochester, who placed there seven canons regular, and gave them in frankalmoin the site, the green before the door and wall of the close, 140 acres of arable land near the precinct and pasture for 120 sheep in his manor.¹ The licence granted by Walter Abbot of St. John Baptist, Colchester (c. 1164-79),² to the poor brothers at Rose's Cross to build a chapel and consecrate a cemetery in the parish of Barkway³ probably relates to Eustace's house.^{3a} The date of Rochester's foundation is fixed as earlier than April 1184 by the bull of Pope Lucius III,⁴ then directed to Simon the prior and the canons, taking under the protection of St. Peter the church of St. John Baptist and St. Thomas the Martyr⁵ at Rose's Cross, and ordering the rule of St. Augustine to be observed there inviolably. They might receive as brothers any clerks or laymen who were free and without ties; those who made profession there must not depart except to enter a stricter order; the election of the prior was to be free; during a general interdict divine service might be celebrated there with closed doors; there was to be free burial there saving the rights of other churches; the convent could present to the parish churches which belonged to them priests who should answer to them for the issues; sentence of

¹ Harl. MS. 7041, fol. 7. The charter of Richard I (see below) gives Eustace alone as founder, but the Prior of Royston in 1277-8 associated Ralph with him (Assize R. 323, m. 46).

² The dates of the early Abbots of Colchester are only approximate (*V.C.H. Essex*, ii, 101).

³ *Cart. Mon. S. Johan. Bapt. de Colecestria* (Roxburghe Club), 513. The document must concern the priory, which was in the parish of Barkway (Inq. a.q.d. file 3, no. 31), while the two hospitals were not. For Rose's Cross see Royston, *V.C.H. Herts.* iii, 253.

^{3a} It must be owned, however, that the mention of a prior seems to point rather to Ralph's foundation.

⁴ Cott. MS. Aug. ii, no. 124. If the house was dedicated from the first to St. Thomas the Martyr, as was said in 1277-8 (Assize R. 323, m. 46), it was founded after 1170. Its foundation was at any rate not before 1163, for Ralph's charter was addressed to Gilbert Bishop of London, 1163-89.

⁵ The first saint was possibly chosen as patron out of compliment to Colchester Abbey. In early times the house was generally called the priory of St. Thomas the Martyr.

excommunication, suspension or interdict was not to be published against them or their church without reasonable cause; and interference with them and their property was forbidden. The pope also confirmed to them their possessions, among which were specified the churches of Coddendam (co. Suffolk) and Chesterton (co. Huntingdon) with certain small tithes and land given by Eustace de Merk, the grant of Ralph de Rochester, and land worth 20s., the gift of Ralph Walensis.

From the charter of Richard I to the priory in November 1189⁶ it appears that Eustace de Merk's endowment included also the church of Owersby⁷ (co. Lincoln) and land in 'Lagefare,' 'Haclinges,' Owersby and Thornton, and that the canons had acquired from other donors small pieces of land in 'Ruyt,' possibly Reed, and Barley (co. Herts.), Melbourn, Bassingbourn and Kneesworth (co. Camb.), 'Halsewic,' probably Alswick in Layston, and 'Wanlinton,' perhaps Wallington. The king confirmed these to the convent and granted them a fair at Royston throughout the week of Pentecost and a weekly market according to the custom of the canons of Dunstable; he gave them sac and soc, tol and team, infangthef and utfangthef and murder; freedom for them and their men and tenants from all scot and geld, aids, hidage, danegeld, shires and hundreds, wardpenny and burghpenny, works of castles; and acquittance of all toll in fairs and markets and crossing of bridges throughout the kingdom; the canons were to have the chattels of thieves and all forfeitures which occurred in their lands or those of their men, and they were not to be impleaded as to their property except before the king and his chief justice. The charter was confirmed in February 1272⁸ and several times afterwards,⁹ and the important privileges it conferred were claimed by the prior and allowed in 1277.¹⁰

Improvements were being made to the house in December 1225, for the king then gave the prior leave to inclose the road beneath the west

⁶ *Cart. Antiq. R.* 6, printed in Dugdale, *Mon.* vi, 405, no. i.

⁷ All three churches were confirmed to them by a papal bull dated 29 July, second year of Pope Celestine, apparently Pope Celestine III, and if so in 1192 (Cott. MS. Aug. ii, no. 130).

⁸ *Cal. Chart. R.* 1257-1300, p. 180.

⁹ In 1344 (*Chart. R.* 18 Edw. III, m. 2, no. 7), 1378 (*Cal. Pat.* 1377-81, p. 181), 1400 (*ibid.* 1399-1401, p. 98), 1413 (*ibid.* 1413-16, p. 136), 1427 (*ibid.* 1422-9, p. 427).

¹⁰ *Plac. de Quo Warr.* (Rec. Com.), 283, 412.

RELIGIOUS HOUSES

wall of the priory for its enlargement,¹¹ and granted him timber to build a chamber for himself.¹²

For the rest, information about the priory during the 13th century relates either to difficulties with other religious bodies¹³ over conflicting liberties or to its additions of property. The canons obtained in 1242 a second fair at Royston to be held on the vigil and feast of St. Thomas the Martyr,¹⁴ and in 1254 a weekly market and annual fair at Chesterton.¹⁵ Part of the manor of Hamerton was acquired c. 1221-2¹⁶; before 1251 they received the manor of Eriswell in Suffolk from William de Rochester,¹⁷ their patron,¹⁸ who gave them besides land in the neighbourhood of Royston¹⁹; from Peter de Rochester they had the mill of 'Beriton' with multure and fishery in Eriswell and Coclesworth²⁰ and a holding in Lakenheath, and from two others land in East and West Reed; and c. 1255 a carucate of land in Chesterton from Giles de Merk.²¹ Houses in Fleet Street, London, were bequeathed to them in 1290 by Richard de Staunford, clerk of the Exchequer, to maintain a chantry in their church,²² a rent of £4 14s. in Royston was alienated to them in 1292 by Isabella de Harleston,²³ and land and rent in Coddendam in 1293 by Geoffrey Lenvyse.²⁴

The priory was not badly off compared with most religious houses in the county, but its resources were perhaps hardly equal to its responsibilities, judging from the constant disturbances within its area of administration.²⁵ Some men of Bassingbourn about 1269 knocked down the walls of Royston and broke the gates²⁶; and business at the Whitsuntide fair in 1292

was suspended by rioters, among whom was the lord of Newsells' steward.²⁷ Some of the convent indeed about 1308 came to close quarters with a gang of robbers.²⁸ The prior and sub-prior, Robert de Bernwell, on this occasion were set upon near Royston; Bernwell ran to the town, collected a band of men, headed the pursuit and took an active part in the affray, during which one robber was killed and others wounded and captured. Without any dispensation for this bloodshed, Bernwell continued to exercise his priestly functions, and was sent by the Bishop of London in 1308 to the pope for absolution.

The spirit of violence had infected the cloister. At the same visitation the bishop found that Ralph de Ashwell, another canon, in the course of a quarrel had badly wounded Bernwell, 'causing great scandal in many parts of England.' Ashwell had also to go to the pope.²⁹

John de Waldene confessed that he had raised his hand against the late prior, and, although he was thereby excommunicate, had celebrated mass, and he therefore begged to be sent to the papal court to obtain dispensation.³⁰ The bishop, however, suspected that Waldene would have preferred the journey to the penance already imposed for other misdeeds, so refusing his request he sent him, as he had intended, to the abbey of St. Osyth, there to be kept in prison and to fast on bread and water twice a week.³¹

These cases give point to some of the episcopal injunctions,³² viz., plotting among the canons, revelation of the secrets of the house, insults and quarrels were to be sharply checked by the prior without respect of persons, and a prison was to be built in a safe place in the house for the punishment of delinquent canons. The others, as might be expected, indicate general carelessness and slackness in discipline, religion and management. Money in lieu of clothes was not to be given to the canons; the sick were to be provided with suitable food; silence was to be kept according to the rule; the decrease in the number of the convent must be remedied as soon as possible; the prior on pain of deprivation was to enforce a better observance of the injunctions of the Archbishop of Canterbury and of the Bishop of London; canons were

¹¹ Providing a new road was made on the prior's land (*Rot. Lit. Claus.* [Rec. Com.], ii, 10).

¹² *Ibid.*

¹³ With the Templars in 1199 (*Rot. Cur. Reg.* [Rec. Com.], ii, 82), 1247 (Assize R. no. 318, m. 12 d.) and 1254 (*Abbrev. Plac.* 137); with the Hospitallers (*Rot. Cur. Reg.* [Rec. Com.], i, 359); and in 1247-8 with the Abbot of Westminster (Assize R. no. 318, m. 5 d.).

¹⁴ *Cal. Chart. R.* 1226-57, p. 218.

¹⁵ *Cal. Pat.* 1247-58, p. 378.

¹⁶ *Abbrev. Plac.* (Rec. Com.), 184-5.

¹⁷ *Cal. Chart. R.* 1226-57, p. 360; *Hund. R.* (Rec. Com.), ii, 196.

¹⁸ The son of Ralph de Rochester (Harl. MS. 7041, fol. 7).

¹⁹ *Ibid.*

²⁰ *Cal. Chart. R.* 1226-57, p. 360. Probably Barton Mills (Coppinger, *Suffolk Rec.* ii, 312).

²¹ *Hund. R.* (Rec. Com.), i, 196.

²² Sharpe, *Cal. of Wills proved in Court of Husting, London*, i, 93.

²³ *Cal. Pat.* 1281-92, p. 476.

²⁴ *Ibid.* 1292-1301, p. 28; Feet of F. Suffolk,

²⁵ Edw. I, no. 25.

²⁶ *V.C.H. Herts.* iii, 259.

²⁷ *Cur. Reg. R.* 189, m. 6, 15 d.

²⁸ Chan. Inq. Misc. file 53, no. 4.

²⁹ *Reg. of Ralph Baldock, Bishop of London* (Cant. and York Soc.), 69-70.

³⁰ *Ibid.* 70.

³¹ The bishop's letter to the pope's penitentiary (*ibid.* 70-1).

³² *Ibid.* 72-3. In January 1310 the bishop empowered the Prior of Royston to mitigate this penance, but John was to have no dealings with women, not to go out of the bounds of the priory, and not to officiate in the church until further orders (*ibid.* 117-18).

³³ *Ibid.* 174-5.

A HISTORY OF HERTFORDSHIRE

not to wander about the town or enter the houses of laymen without good cause, the prior's leave being first obtained, nor eat and drink except in the refectory, infirmary or the prior's room; women, especially those of the neighbourhood, were not to eat within the precincts nor enter the cloister and other places reserved to the convent, unless the prior gave permission in the case of women of good repute coming with a proper escort; the brothers were to eat and sleep together and be present at the services day and night; no office was to be committed to a canon not instructed in his rule; obedientiaries and those receiving the goods of the house must render accounts at least once a year, and the prior must make known the state of their affairs and consult the most experienced of the convent about expenditure.

In 1310 another canon had to seek papal absolution for celebrating service while excommunicated for violence.³³ This man, Walter de Kelishulle, had behaved like one frenzied: he had assaulted the prior and a clerk so as to draw blood, attacked one of the convent with drawn sword in the church, and dragged the sub-prior about the room, tearing his clothes off his back. In September he was consigned by the bishop to St. Osyth's,³⁴ with directions that he was to be last in quire, cloister, chapter, refectory, and dormitory, attend all the services, and celebrate mass daily; and except at the most important festivals he was to have only bread, soup and ale on Thursdays and Saturdays. The punishment in this instance appears light for the offence, and it would be interesting to know all the circumstances. It is evident that Bishop Baldock considered the prior most unsatisfactory. Geoffrey Hakoun seems to have had a special faculty for surrounding himself with undesirable familiars and servants. By an injunction of 1308 Robert Cook was to be removed from all office. Later³⁵ the prior was ordered to avoid the company of John Loth, who was to be deprived of office after rendering account, and to remove the warden of Eastwood, putting in his place a trustworthy person with the convent's consent. He himself was forbidden under pain of deprivation to alienate property without urgent necessity, as he had done, or contract heavy loans without the convent's assent; and in future he must neither receive nor spend the issues of the priory save in the presence of a canon deputed by the rest.

In 1311 Hakoun practically set the bishop at defiance by procuring from the general chapter of the order the reversal of his commands about John de Waldene and the administration of

the conventual property,³⁶ and in April 1313 was threatened with excommunication and deprivation by the bishop if he did not observe his injunctions, hitherto utterly neglected.³⁷ What happened in the end is not known. Bishop Baldock died shortly afterwards, and Hakoun remained in possession until November 1314 and then resigned,³⁸ possibly under pressure, for the choice of a canon from another house to succeed him hints at reform.³⁹

Surrounding conditions probably made maintenance of discipline and management of property particularly difficult here. The prior complained in 1313 that the gates and doors of the priory had been broken and the bailiff of his market assaulted,⁴⁰ and in 1314 that his goods had been carried off.⁴¹

The house continued to add to its possessions. The manor of Reed was bought in 1303 from Adam de Twynham⁴²; in 1354 land and rent in Cokenhatch and Reed were acquired from William de Norton⁴³ and 70 acres in Cokenhatch from Michael de Spayne the next year⁴⁴; and grants of land in West Reed, Royston and Buckland were made to the convent by Thomas Palfreyman between 1358 and 1368,⁴⁵ partly to maintain a lamp at the high altar of their church and to endow a chantry and obit. The prior and convent also received from William Slyng and his wife Maud in 1363 a messuage in Holborn worth 8s. a year to find a candle at high mass on Sunday before the high altar.⁴⁶ In 1385 they obtained licence to acquire property in mortmain to the annual value of £10,⁴⁷ and in 1386 William Koo gave them messuages in Royston to half the amount.⁴⁸ Edmund Earl of March, their patron,⁴⁹ bequeathed 40 marks to the house in 1382-3 that a daily mass might be celebrated for his soul for a year.⁵⁰

William Pynchbek, who had been made prior in March 1398-9,⁵¹ was accused with two of the

³⁶ *Reg. of Ralph Baldock, Bishop of London* (Cant. and York Soc.), 146-7.

³⁷ *Ibid.* 176.

³⁸ Leave to elect was given 5 Nov. 1314 (*Cal. Pat.* 1313-17, p. 195).

³⁹ *Ibid.* p. 202.

⁴⁰ *Ibid.* p. 62.

⁴¹ *Ibid.* p. 229.

⁴² *Cal. Close*, 1302-7, p. 92.

⁴³ *Cal. Pat.* 1354-8, p. 52.

⁴⁴ *Ibid.* p. 191.

⁴⁵ *Pat.* 32 Edw. III, pt. i, m. 1, 26; 37 Edw. III, pt. i, m. 20, 39; 40 Edw. III, pt. ii, m. 8, 9; 42 Edw. III, pt. i, m. 12.

⁴⁶ *Cal. Pat.* 1361-4, p. 401.

⁴⁷ They paid 20 marks for it (*ibid.* 1385-9, p. 45).

⁴⁸ *Ibid.* p. 238.

⁴⁹ See below.

⁵⁰ Nichols, *Royal Will*, 109-16. Elizabeth Lady Clare, by will proved 1360, left the priory 60s. and two cloths of gold (*ibid.* 23-43).

⁵¹ *Lond. Epis. Reg.* Braybrook, fol. 304-6.

³³ *Reg. of Ralph Baldock, Bishop of London* (Cant. and York Soc.), 125.

³⁴ *Ibid.* 133.

³⁵ *Ibid.* 175-6.

RELIGIOUS HOUSES

canons, John Burgh and Walter Adam, in 1401 of having procured his election through secular power and simony.⁶² They denied the charge, and cleared themselves before the bishop's commissary by bringing beneficed clergymen to testify to their life and conduct.

Except as regards its temporal jurisdiction,⁶³ very little is heard of the house for a century.

In 1517 two changes were made at the priory by Bishop Fitz James at the request of Robert White, the prior.⁶⁴ To replace more easily the service books now worn out, the adoption of the Sarum use was authorized instead of that of Bangor. The feast of the dedication of the conventual church was at the same time transferred from 22 June to 19 October, because the former date came too near St. John Baptist's Day, the festival of the place.

The church was then undergoing repairs, which must have extended over some time, for Thomas Gery in 1517 left 40s. for that purpose, and in 1527 a bequest of £10 was made by William Lee to complete the chancel roof.⁶⁵

When White died on 1 April 1534⁶⁶ a difficulty arose between the convent and the Earl of Oxford, who as owner of Newsells believed he had a voice in the selection of the prior. Richard Bretten, one of the canons, he told Cromwell, was canvassing the gentlemen and yeomen of the district ostensibly to have a free election, but really to get the post for himself⁶⁷; and in Cromwell's statement that the king was founder he could only see the result of Bretten's intrigues.⁶⁸ But Bretten was right on both counts. The patronage of the priory had long since passed from the lords of Newsells, and belonged to the king as heir of the Mortimers⁶⁹; and the choice of the prior rested with the convent. The *congé d'élire* was given on 14 May,⁶⁰ Richard Bretten was chosen, and the king assented on 12 June to his election.⁶¹ The affair, however, was evidently not yet settled. Bretten appears to have been absent

when the acknowledgement of the royal supremacy was made by the house, 1 July 1534,⁶² and although he was styled prior in October, when he borrowed 20 marks for his monastery 'in his great necessity,'⁶³ the royal assent was given a second time in December.⁶⁴

The Earl of Oxford had called him unthrifty and unfit for rule, and declared that he would ruin the house, but his opinion is too biased to be trustworthy, and the available evidence is all in Bretten's favour. The commissioners who received the surrender of the priory in 1537 pronounced the convent to be of very good report and name and the building in very good repair.⁶⁵

At the dissolution of the house on 9 April 1537 Bretten received an annual pension of £16 13s. 4d., but the other six canons were dismissed with a small present.⁶⁶

The goods were worth £132 13s. 6d.⁶⁷ and the plate £30 3s. 2½d.⁶⁸; the lead was valued at £28 and the three bells at £29.⁶⁹ The income of the priory in 1291 was about £61⁷⁰; in 1535 it was reckoned at £89 16s. net,⁷¹ perhaps a low estimate, as its gross revenues in 1537 were at least £133.⁷²

⁶² *Dep. Keeper's Rep.* vii, App. ii, 299. The document was signed by the sub-prior and eight other canons.

⁶³ Kingston, *op. cit.* 53, note 1.

⁶⁴ *L. and P. Hen. VIII.*, vii, 1601 (23).

⁶⁵ Transcript of Land Rev. Rec. bdle. 66, no. 3.

⁶⁶ *Mins. Accts. Hen. VIII.*, no. 1606, schedule. The sum of £11 13s. 4d. was divided among the canons, a priest and twenty-four servants.

⁶⁷ *Aug. Off. Misc. Bks.* ccclxi, fol. 67-68 d. This amount, however, included the cloister and dormitory, sold for £24, a house next the porter's lodge for £20, and the future crops of the sown fields, £50 9s. 8d. The stuff in the hall, buttery, pantry, kitchen and bakehouse fetched £8 5s. The church apparently contained nothing very valuable. The stuff at our Lady's and St. Katharine's altars and in the rood chapel brought in only 12s., the organ in the quire 40s., and another 11s. There were several suits of vestments, green baudekin, black worsted, black camlet, shot silk, red velvet, a very old one of damask, and another of tawny velvet and 9 copes, but the highest price given for any was 30s.

⁶⁸ *Ibid.* fol. 68 d.-69. A cross of silver-gilt weighing 44 oz., a silver censer of the same weight, 2 silver chalices, parcel gilt, 12 silver spoons, a salt with cover, parcel gilt, the garnishing of 2 great mazer bands gilt and of 2 little mazer bands gilt. There is also an account of goods and plate in K.R. Church Goods $\frac{1}{8}$, in which the value was estimated lower.

⁶⁹ *Mins. Accts. Hen. VIII.*, no. 1606.

⁷⁰ *Pope Nich. Tax.* (Rec. Com.), 12b, 14b, 18, 25b, 28b, 36, 50b, 51, 51b, 115, 129b, 130, 266b, 269. The whole amount was £71 14s. 5d., but the vicar of Coddenham was paid £10 13s. 4d.

⁷¹ *Valor Eccl.* (Rec. Com.), iv, 289.

⁷² *Mins. Accts. Hen. VIII.*, no. 1606.

⁵⁹ *Lond. Epis. Reg.* Braybrook, fol. 350.

⁶⁰ The prior's claim to the market at Royston was challenged in 1434 (*Memo. R. [L.T.R.]*, Rec. Hil. 12 Hen. VI, m. 18), and a difficulty arose over the alleged escape of a felon from Royston (*ibid.*).

⁶¹ *Lond. Epis. Reg.* Fitzjames, fol. 117 d.

⁶² Kingston, *Hist. of Royston*, 56, 81, 84.

⁶³ Add. MS. 5828, fol. 26 d.

⁶⁴ *L. and P. Hen. VIII.*, vii, 517.

⁶⁵ *Ibid.* 537.

⁶⁶ Alice de Scales, who inherited Newsells from the Rochesters, made over the patronage about the middle of the 13th century to the Earl of Gloucester (*Harl. MS.* 7041, fol. 8). At the division of the Gloucester estates after Earl Gilbert's death in 1314 it was allotted to Elizabeth Lady Clare (*ibid.* fol. 6), and passed by the marriage of her daughter and heir to the Mortimers (*Chan. Inq.* p.m. 22 Ric. II, no. 34).

⁶⁷ *L. and P. Hen. VIII.*, vii, 761 (29).

⁶⁸ *Ibid.* 922 (26).

A HISTORY OF HERTFORDSHIRE

PRIORS OF ROYSTON

Simon, occurs April 1184⁷³
 W., occurs October 1229⁷⁴
 Osbert, occurs 28 October 1254⁷⁵
 Richard, occurs 1290⁷⁶ and 1294⁷⁷; Richard de Leccinton died c. 1297⁷⁸
 Thomas, occurs May 1302⁷⁹
 Geoffrey, occurs 1313,⁸⁰ resigned 1314⁸¹
 John de Broome,⁸² elected 1314⁸³
 John de Beauchamp, occurs 1339⁸⁴
 Thomas, occurs 1346⁸⁵
 John de Arneburgh, occurs 1354,⁸⁶ 1361⁸⁷ and 1362,⁸⁸ and died 25 July 1369⁸⁹
 John West, elected 9 August 1369⁹⁰; John occurs 25 November 1383⁹¹
 John Adam, died 10 March 1398-9⁹²
 William de Pynchbek, elected 21 March 1398-9,⁹³ occurs October 1401⁹⁴
 Walter (Adam), occurs 15 October 1413⁹⁵
 Richard, occurs 24 October 1427,⁹⁶ 1434,⁹⁷ February 1439,⁹⁸ died 24 December 1441⁹⁹
 George Wright, elected 23 February 1441-2¹⁰⁰
 John Borough, occurs 30 November 1451,¹ died 26 April 1484²

⁷³ Cotton MS. Aug. ii, fol. 124.

⁷⁴ *Cal. Close*, 1227-31, p. 225.

⁷⁵ *Cal. Pat.* 1247-58, p. 378. He was prior when Alice de Scales transferred the patronage of the priory to the Earl of Gloucester (Harl. MS. 7041, fol. 8).

⁷⁶ Memo. R. (L.T.R.), Mich. 18 & 19 Edw. I, m. 6 d.

⁷⁷ Feet of F. Suffolk, 22 Edw. I, no. 25.

⁷⁸ *Cal. Pat.* 1292-1301, p. 377.

⁷⁹ *Cal. Close*, 1296-1302, p. 553.

⁸⁰ *Baldock's Reg.* (Cant. and York Soc.), 175.

⁸¹ Here called Geoffrey Hakoun (*Cal. Pat.* 1313-17, p. 195).

⁸² He was a canon of St. Botolph's, Colchester.

⁸³ Royal assent given 4 Dec. (*Cal. Pat.* 1313-17, p. 202).

⁸⁴ Add. Chart. 44502. ⁸⁵ *Feud. Aids*, v, 53.

⁸⁶ Add. MS. 5843, p. 247.

⁸⁷ *Cal. Pat.* 1361-4, p. 40.

⁸⁸ *Cal. Close*, 1360-4, p. 408.

⁸⁹ Lond. Epis. Reg. Sudbury, fol. 144.

⁹⁰ Ibid.

⁹¹ *Cal. Pat.* 1381-5, p. 330. This may be John Adam.

⁹² Lond. Epis. Reg. Braybrook, fol. 306.

⁹³ Ibid.

⁹⁴ Ibid. fol. 350. In Nov. 1414 he was made chaplain of a hermitage in Norfolk (*Cal. Pat.* 1413-16, p. 254).

⁹⁵ *Cal. Pat.* 1413-16, p. 136. Walter Adam occurs as prior in the time of Henry IV (ibid. 1422-9, p. 370). ⁹⁶ Ibid. p. 427.

⁹⁷ Memo. R. (L.T.R.), Hil. 12 Hen. VI, m. 18. Here called Richard Hugh.

⁹⁸ *Cal. Chart. in Bodleian Lib.* 89. Here called Richard Higham.

⁹⁹ Dugdale, *Mon.* vi, 405. ¹⁰⁰ Ibid.

¹ Aug. Off. Leases, iv, no. 136.

² Add. MS. 5820, fol. 24 d.

John Kyrkeby, occurs temp. Henry VII³
 Robert White, occurs 1517,⁴ September 1521,⁵ August 1532,⁶ died 1 April 1534⁷
 Richard Bretten, elected 1534,⁸ surrendered March 1537⁹

The seal of this priory, of 15th-century date,¹⁰ is vesica-shaped, with a design of two niches with elaborate canopies and having tabernacle work at the sides; in the one on the right stands St. Thomas of Canterbury with mitre and crozier, blessing with his right hand; in that on the left is another saint, presumably St. John Baptist. Below under the round-headed arch supporting the niches is a little figure of a prior praying. Legend: SIGILLŪ · COMMUNE · FORAT . . . DOMUS . . . E · THOME · DE · RO . . .

II. WYMONDLEY PRIORY

The hospital¹ or priory of Austin canons at Little Wymondley, dedicated to the honour of St. Mary,² was founded by Richard de Argentine,³ the lord of the manor, apparently at the beginning of the reign of Henry III, but of the endowment nothing is known except that it included land in Wymondley⁴ and the church of Little Wymondley, of which the master of the hospital was put in possession in 1218 on the resignation of the parson and vicar.⁵ The patron's rights did not include a voice in the selection of the head of the house, for although

³ Aug. Off. Leases, iv, no. 139.

⁴ Lond. Epis. Reg. Fitzjames, fol. 117 d.

⁵ Add. MS. 5820, fol. 26 d.

⁶ Without the surname (Aug. Off. Leases, iv, no. 135).

⁷ Add. MS. 5820, fol. 26 d.

⁸ *L. and P. Hen. VIII*, vii, 922 (26).

⁹ Ibid. xii (1), 571 (2).

¹⁰ B.M. Seals, lxiv, 71.

¹ During the 13th century it was often styled 'hospital' (*Rolls of Hugh de Welles* [Cant. and York Soc.], i, 141; iii, 43; *Cal. Close*, 1231-4, p. 84; *Cal. Pat.* 1281-92, p. 195; Pipe R. 19 Edw. I), but apparently not afterwards.

² The house seems generally to have been called the priory or hospital of St. Mary in the 13th and 15th centuries (*Rot. Lit. Claus.* [Rec. Com.], ii, 88; *Cal. Close*, 1226-57, p. 159; *Cal. Pat.* 1281-92, p. 195; B.M. Seals, lxiv, 74), but Tanner (*Notit. Mon.*) says it was dedicated to St. Lawrence. Possibly it had a double dedication, for the two altars in the church mentioned by name at the dissolution of the priory were those of St. Lawrence and our Lady (K.R. Church Goods, $\frac{1}{8}$ 8).

³ Visit. of Bp. Alnwick, 1442 (Doc. of Bp. of Linc. at Exchequer Gate).

⁴ *Hund. R.* (Rec. Com.), i, 183.

⁵ *Rolls of Hugh de Welles* (Cant. and York Soc.), i, 141. The prior and brothers presented a vicar in 1223 (ibid. iii, 43), so they evidently did not at first serve the church themselves.

RELIGIOUS HOUSES

Giles de Argentein, Richard's son and successor opposed the election of a canon of Dunstable as Prior of Wymondley in 1247, he was unsuccessful.⁶

The convent acquired various property during the first seventy years of its existence. In 1232 Henry III granted them a virgate of land in Dinsley⁷ for 5s. a year and the maintenance of his anniversary and that of King John; in 1275 they owned a carucate of land in the hundred of Hertford, bought of Ivo de Hoverile⁸; they then had land also in Beeston, co. Nottingham,⁹ and in 1278 held in Tewin 40 acres,¹⁰ to which 80 acres more were added in 1285 by the gift of Walter de Neville.¹¹

The resources of the house, however, were still inadequate to its needs. William Dalderby, Bishop of Lincoln, in 1315 wrote to the rectors and vicars throughout the archdeacons of Buckingham, Oxford, Bedford and Huntingdon, requesting them to permit the proctors of the poor canons of Wymondley to solicit the alms of the faithful within their districts, and offering an indulgence of forty days to those who gave to them¹²; and in 1323 Bishop Burghersh sent similar letters to the clergy of his diocese and granted an indulgence for the benefit of the canons.¹³

The house seems also to have had other difficulties at the beginning of the 14th century. John de Wymondley, the prior, who had ruled for ten years,¹⁴ was removed in 1300,¹⁵ and after a long delay,¹⁶ which points to disagreements among the canons, John de Mordon, a former prior, was reinstated.¹⁷ Mordon died in 1304, and was succeeded by Elias de Wheat-hampstead,¹⁸ but it was not until 1310 that John de Wymondley at last formally resigned.¹⁹

The canons, in electing John de Buckden prior in 1340, seem hardly to have chosen a person circumspect in temporal affairs, as advised by their bishop.²⁰ He was accused, with others, in March 1345²¹ of 'attempting things

very prejudicial to the king and his crown, which if allowed to proceed will be not only to the king's prejudice and the subversion of laws and the rights of the crown, but also to the manifest lesion of ecclesiastical liberty.' Unfortunately the offence for which his arrest was ordered is not stated, but it possibly was connected with the suit brought against him at that date by Joan daughter of the late John de Argentein for detaining a charter entrusted to Elias his predecessor.²²

The Argentein deeds caused a later Prior of Wymondley some unpleasantness. As he was on his way to Halesworth, co. Suffolk, in 1382, to assist at the funeral of John de Argentein, he was seized at Newmarket by the partisans of one of the heirs and forced to surrender certain muniments which John had deposited in the priory for safety.²³

The inconsiderable bequests made to the priory by Argentein²⁴ were apparently but a small portion of what the convent obtained at his death, for under the will of Ann Maltravers, John's mother,²⁵ they were then to receive²⁶ a great cup with a cover, a dragenall, 6 dishes, 6 pottingers, 6 saucers, 2 pitchers and 2 pottles, all of silver, as well as a 'dozer' of green powdered with dolphins and 4 'cousters' of the same suit.

Some land in Hertford was given to the convent in 1330 by Roger de Luda to maintain a chantry in Tewin Church,²⁷ and four cottages in Shefford (in Campton, co. Beds.) in 1392 by John Cokkowe for a chantry in the priory.²⁸ An indulgence for their relief granted by the Bishop of Ely in 1394²⁹ shows that they then needed help. When the house was visited by Bishop Alnwick in 1442³⁰ its general state was quite satisfactory, none of the four canons having any complaints to make. It had then an annual income of £20 clear, which cannot have offered much margin for extra expenditure.

At the visitation of May 1530³¹ the one question of importance was the financial situation, which was certainly gloomy in the extreme. The prior had just spent 100 marks on the

²² Plac. de Banco East. 19 Edw. III, rot. 144, given in *Year Bk.* 19 *Edw. III* (Rolls Ser.), 23, n. 6, &c.

²³ *Cal. Pat.* 1381-5, p. 260.

²⁴ 20s. for the repair of the priory and 20s. to the convent to celebrate for his soul (Gibbons, *Early Lincoln Wills*, 25).

²⁵ Chan. Inq. p.m. 49 Edw. III, pt. ii, no. 17.

²⁶ The articles were left to John for his life with remainder to the priory (Nicolas, *Test. Vetusta*, 91).

²⁷ *Cal. Pat.* 1333-4, p. 17.

²⁸ *Ibid.* 1391-6, p. 187.

²⁹ Gibbons, *Cal. of Ely Epis. Rec.* 399.

³⁰ Visit. of Bp. Alnwick (Doc. of Bp. of Linc. at Exchequer Gate).

³¹ Visit. of John Rayne, chancellor of the diocese (*ibid.*).

⁶ *Ann. Mon.* (Rolls Ser.), iii, 175.

⁷ *Cal. Chart. R.* 1226-57, p. 159. It was before committed to them during pleasure (*Rot. Lit. Claus.* [Rec. Com.], ii, 88).

⁸ *Hund. R.* (Rec. Com.), i, 191.

⁹ *Ibid.* ii, 314.

¹⁰ *Assize R.* 323, m. 13 d.

¹¹ *Cal. Pat.* 1281-92, p. 195.

¹² *Linc. Epis. Reg. Dalderby*, Memo. fol. 311.

¹³ *Ibid.* Burghersh, Memo. fol. 109 d.

¹⁴ *Ibid.* Sutton, Inst. fol. 84 d.

¹⁵ *Ibid.* Dalderby, Inst. fol. 231.

¹⁶ *Ibid.* Dalderby, Memo. fol. 11.

¹⁷ He must have been a man of good character or the bishop would not in 1302 have made him confessor of the nuns of Rowney (*ibid.* fol. 44).

¹⁸ *Ibid.* Dalderby, Inst. fol. 235 d.

¹⁹ *Ibid.* fol. 242.

²⁰ *Ibid.* Burghersh, Memo. fol. 371.

²¹ *Cal. Pat.* 1343-5, p. 501.

A HISTORY OF HERTFORDSHIRE

belfry, and other parts of the church were still badly in need of repairs,³² while to add to the difficulties of the convent eighty of their sheep had died that year, and only eighteen were left.

The acknowledgement of the royal supremacy was signed on 14 October 1534 by the prior and four canons,³³ and there were five religious living there,³⁴ according to the royal commissioners 'of slender report,' on 6 April 1537, when the house was dissolved³⁵ as one of the smaller monasteries. The prior, John Atewe³⁶ or Yate,³⁷ was given a pension of £5³⁸; the other canons received a present only.³⁹ It is not surprising to find that in 1537 the buildings were in ruin and decay.⁴⁰ The only piece of plate there then was a chalice valued at 72s. 9d.,⁴¹ but a few years before the convent had certainly had more.⁴² The four bells, weighing 24 cwt.,⁴³ were probably those noted in 1442 as lately bought.⁴⁴

The income of the house in 1526 was said to be £46 gross and £23 8s. 6d. net⁴⁵; in 1535 it was reckoned at £29 19s. 11½d. net,⁴⁶ and at the Suppression £23 clear, apart from demesne lands worth 107s.⁴⁷ The canons were rectors of Little

³² The chancel and nave were both in a ruinous state, and they were not the only buildings in this condition; yet £12 had been spent on repairs in 1526 (Salter, *A subsidy collected in the diocese of Lincoln in 1526*, p. 192).

³³ *Dep. Keeper's Rep.* vii, App. ii, 306. This seems to have been the usual number, for there were five brothers in the priory in 1442 (Visit. of Bp. Alnwick) and five also in 1530 (Visit. of Chancellor Rayne), if John Atue, curate of Little Wymondley, is included.

³⁴ Transcript of Land Rev. Rec. bdle. 66, no. 3.

³⁵ Mins. Accts. Hen. VIII, no. 1606.

³⁶ *Ibid.*

³⁷ *L. and P. Hen. VIII*, xiii (1), 1520. ³⁸ *Ibid.*

³⁹ The sum of £9 1s. 8d. was divided among them and eleven servants (Mins. Accts. Hen. VIII, no. 1606).

⁴⁰ Transcript of Land Rev. Rec. bdle. 66, no. 3.

⁴¹ Aug. Off. Misc. Bk. cccxli, fol. 66. The total of the goods and plate is given at £13 12s. 9d. In the inventory made by the commissioners just before the Suppression (K.R. Church Goods $\frac{1}{8}\frac{2}{8}$) it was estimated at £6 19s. 5d., and this sum included 44s. for crops sown and 25s. for five cart-horses. The stuff in the quire was very poor, the article of the highest value being a pair of organs priced at 5s., while the only vestments were apparently a very old one of blue silk valued at 20d., two others, one of baudekin, the other of red silk, reckoned at 3s., and an old cope at 8d. (*ibid.*).

⁴² At the visitation of 1530 they had more than one chalice and a silver ship.

⁴³ Mins. Accts. Hen. VIII, no. 1606.

⁴⁴ Visit. of Bp. Alnwick. The canons in 1530 said they had, and had of old, four bells (Visit. of Chancellor Rayne). ⁴⁵ Salter, *op. cit.* 192.

⁴⁶ *Valor Eccl.* (Rec. Com.), iv, 276.

⁴⁷ Land Rev. Rec. bdle. 66, no. 3.

Wymondley, the church of which was served by one of them as curate.⁴⁸

PRIORS OF WYMONDLEY

William, occurs c. 1218⁴⁹

Hugh, occurs 1233-4⁵⁰

Martin, instituted 1246, died 1247-8⁵¹

Richard de Waldia, elected March 1247-8,⁵² occurs 1251⁵³

John de Mordon, resigned 1290⁵⁴

John de Wymondley, elected 1290,⁵⁵ deprived 1300⁵⁶

John de Mordon, re-elected 1300,⁵⁷ occurs 1302,⁵⁸ died 1304⁵⁹

Elias de Wheathampstead, elected 1304,⁶⁰ occurs 1310,⁶¹ died 1340⁶²

John de Buckden, elected 1340,⁶³ occurs 1345,⁶⁴ died 1347⁶⁵

William Legat, died March 1349⁶⁶

Roger de Beston, elected 1349,⁶⁷ resigned 1 May 1374⁶⁸

John Anabull, resigned 1404-5^{68a}

John Stevens, instituted February 1404-5⁶⁹

Richard Chapman, occurs November 1442⁷⁰

John Bawdry, died 1478⁷¹

William Howse or Hawes, elected 1478,⁷² occurs 1488,⁷³ resigned 1513⁷⁴

Robert Ellys, elected 1513,⁷⁵ resigned 1520⁷⁶

William Weston, elected in 1520,⁷⁷ occurs 1530,⁷⁸ died 1531⁷⁹

⁴⁸ Parochial Visit. of 1527 (Doc. of Bishopric of Linc. at Exchequer Gate); Mins. Accts. Hen. VIII, no. 1606.

⁴⁹ Temp. Mabel Abbess of Elstow (Cott. MS. Nero, E vi, fol. 128).

⁵⁰ Feet of F. Herts. 18 Hen. III, no. 168.

⁵¹ Clutterbuck, *Hist. and Antiq. of Herts.* ii, 548.

⁵² *Ann. Mon.* (Rolls Ser.), iii, 175.

⁵³ Richard Prior of Wymondley (Anct. D. [P.R.O.], D 506).

⁵⁴ Linc. Epis. Reg. Sutton, Memo. fol. 2.

⁵⁵ *Ibid.* Inst. fol. 84 d.

⁵⁶ *Ibid.* Bp. Dalderby, Inst. fol. 231.

⁵⁷ *Ibid.* ⁵⁸ *Ibid.* Bp. Dalderby, Memo. fol. 44.

⁵⁹ *Ibid.* Dalderby, Inst. fol. 235. ⁶⁰ *Ibid.*

⁶¹ *Ibid.* fol. 242.

⁶² *Ibid.* Burghersh, Memo. fol. 371. ⁶³ *Ibid.*

⁶⁴ *Cal. Pat.* 1343-5, p. 501.

⁶⁵ *Ibid.* 1345-8, p. 262.

⁶⁶ Linc. Epis. Reg. Gynwell, Inst. fol. 344.

⁶⁷ *Ibid.*

⁶⁸ *Ibid.* Buckingham, Memo. pt. i, fol. 134 d.

^{68a} Clutterbuck, *op. cit.* ii, 549. ⁶⁹ *Ibid.*

⁷⁰ Visit. by Bp. Alnwick (Doc. of Bp. of Linc.).

⁷¹ Linc. Epis. Reg. Rotheram, Inst. fol. 119.

⁷² *Ibid.* ⁷³ Early Chan. Proc. bdle. 366, no. 1.

⁷⁴ Linc. Epis. Reg. Smith, Inst. fol. 427.

⁷⁵ *Ibid.*

⁷⁶ *Ibid.* Wolsey and Atwater, Inst. fol. 49. He was receiving a pension in 1526 (Salter, *op. cit.* 192).

⁷⁷ Linc. Epis. Reg. Wolsey and Atwater, Inst. fol. 49.

⁷⁸ Visit. of Chancellor Rayne (Doc. of Bp. of Linc. at Exchequer Gate).

⁷⁹ Linc. Epis. Reg. Longland, Inst. fol. 224 d.

RELIGIOUS HOUSES

John Dorchester, elected 1531,⁸⁰ occurs
14 October 1534⁸¹
John Atue or Yate, occurs 4 March 1537⁸²
The oval 14th-century seal of this house⁸³

represents the Virgin crowned and standing with the Child on her left arm in a niche, with a pinnacled and crocketed canopy. The field is powdered with slipped roses. Legend: [s'] CAPITVLI BEA(TE MAR) IE DE WILMVNDE . . .

HOUSE OF GILBERTINE CANONS

12. NEW BIGGING PRIORY, HITCHIN

The priory of St. Saviour, New Bigging, Hitchin,¹ was founded by Sir Edward de Kendale, kt., at the end of 1361 or beginning of 1362² for three canons of the Gilbertine order, of whom one was to be prior.³

Tanner and others have called this house a nunnery, but as there had to be at least seven canons in a double establishment⁴ of the Gilbertine order, there could have been no women there at the foundation, and there is no trace of any afterwards.⁵

Kendale received the royal licence in February 1362-3⁶ to give to the prior and canons in order that they might celebrate for the souls of Robert and Margaret de Kendale, his father and mother, and of King Edward II, the advowson of the church of Orwell (co. Cambridge) and some land there which Margaret had intended to assign for this purpose to the warden and chaplains of the chapel of St. Peter in the church of Hitchin. The canons at the same time had leave to appropriate Orwell Church to their own uses.

From William Rous, chaplain, the convent in 1372 obtained eight messuages, 63 acres of land and 3s. rent in Willian and Hitchin in aid of their maintenance.⁷ The resources of the house, no doubt still very small, were augmented thirty years later by other means. On 22 September 1402 the pope empowered the canons

to choose eight priests, seculars and regulars, to hear the confessions of and absolve penitents who on the feast of the Annunciation between the first and second vespers visited and gave alms for the conservation of the priory church, and granted to such penitents the same indulgence as to persons visiting on 1-2 August the church of St. Mary of the Portiuncula, Assisi.⁸

The grant was perhaps made to meet a special emergency, for the statement in 1400 that Sir Robert Turk, kt., held a free chapel in Hitchin called 'le Bygynge'⁹ may mean that he had a mortgage on the place.

The house, the net annual value of which was returned in 1535 as £13 16s.,¹⁰ figured in 1536 among the smaller monasteries marked out for suppression,¹¹ and in that year Rauf Morice was petitioning Cromwell for a farm of the priory.¹² As, however, the first Ministers' Accounts¹³ of the place date from Michaelmas 1538, and the prior was not granted a pension¹⁴ until December of that year, the priory appears to have escaped dissolution¹⁵ until the surrender of the parent-house of Sempringham in September 1538.¹⁶

John Mounton, the last prior,¹⁷ is the only one recorded.

⁸ *Cal. of Papal Letters*, iv, 349. The indulgence in 1402 for the benefit of certain religious dwelling by the vill of Hitchin is mentioned in 'Annals Ric. II et Hen. IV,' see Trokelowe and Blanford, *Chron. et Ann.* (Rolls Ser.), 348.

⁹ Chan. Inq. p.m. 2 Hen. IV, no. 36.

¹⁰ *Valor Eccl.* (Rec. Com.), iv, 276.

¹¹ *L. and P. Hen. VIII*, ix, 1238.

¹² *Ibid.* xi, 1479.

¹³ Hen. VIII, no. 1617.

¹⁴ £4 a year until he received an ecclesiastical benefice of that amount (Aug. Off. Misc. Bks. ccxxxiii, fol. 97).

¹⁵ The commissioners who dissolved the small houses made no report on New Bigging, but sent the prior to the Chancellor of the Court of Augmentations (Land Rev. Rec. bde. 66, no. 3).

¹⁶ *V.C.H. Lincoln*, ii, 186. It is here pointed out that the master of Sempringham used his influence with Cromwell to save the small Gilbertine houses from dissolution under the Act of 1536.

¹⁷ *L. and P. Hen. VIII*, xiv (2), 1355.

⁸⁰ Linc. Epis. Reg. Longland, Inst. fol. 224 d.

⁸¹ *Dep. Keeper's Rep.* vii, App. ii, 306.

⁸² *L. and P. Hen. VIII*, xii (1), 571 (4).

⁸³ B.M. Seals, lxiv, 74.

¹ *Cal. of Papal Letters*, iv, 349.

² The inquisition *ad quod damnum* preceding Kendale's grant of land to the canons for their buildings took place in November 1361 (Inq. a.q.d. file 340, no. 4).

³ *Ibid.*

⁴ Graham, *St. Gilbert of Sempringham and the Gilbertines*, 33.

⁵ The lack of proof that New Bigging was a house for both sexes has been noticed by Messrs. Pollard and Gerish, 'The Religious Orders in Hitchin,' *East Herts. Arch. Soc.* iii (1), 3.

⁶ Pat. 37 Edw. III, pt. i, m. 37.

⁷ *Ibid.* 46 Edw. III, pt. ii, m. 32.

A HISTORY OF HERTFORDSHIRE

HOUSE OF KNIGHTS HOSPITALLERS

13. PRECEPTORY OF STANDON

The Knights Hospitallers received from Gilbert de Clare Earl of Hertford, in the reign of King Stephen,¹ the church of Standon and 140 acres of land and his vineyard in this parish,² and from Gilbert's brother and successor Roger before 1174³ a mill outside the gate of Standon.⁴ Here, according to Tanner, a preceptory was established for sisters of the order, who in 1180 were removed to Buckland (co. Somerset).⁵ As regards the sisters no evidence has been found, but it seems certain that the knights had at one time a preceptory here. In certain agreements of 1280 and c. 1291-3 the Hospitallers arranged that payments should be made to 'their house of Standon,'⁶ and all doubt about the connexion of the hospital of Standon mentioned in 1319-20⁷ and in 1323⁸ with the Knights of St. John is removed by the entries in the manorial court rolls of 1360.⁹

Scarcely anything is known of the history of the house. The master in 1319-20 was accused of carrying off the corn of the lord of the manor from the fields by night and of assaulting the lord's reaper¹⁰; but when the prior, apparently as the master's superior, answered the charges¹¹ it was found that the Hospitallers had only taken their own corn. In 1323 the master was said to have broken into the king's parks of Little Hadham and Milkeley, hunted there and carried off the deer.¹² Possibly the character of the head of the house at Standon had something to do with the neglect of duties¹³ incumbent on the Hospitallers, of which from 1320 to 1328 there are frequent complaints.

¹ Earl Gilbert's grandfather died in 1150 and was succeeded by his son Richard. Gilbert himself died in 1152 (*Dict. Nat. Biog.*).

² Confirmation by King John, August 1199 (*Cal. Rot. Chart.* 1199-1216 [Rec. Com.], 16).

³ He died before July or August 1174 (*Dict. Nat. Biog.*).

⁴ Confirmation by Roger's son Richard Earl of Hertford (Cott. MS. Nero, E vi, fol. 123).

⁵ Tanner, *Notitia Mon.*

⁶ Cott. MS. Nero, E vi, fol. 119. The same expression is used for Clerkenwell in an indenture of 1376 (*ibid.* fol. 138).

⁷ Ct. Rolls (Gen. Ser.), portf. 178, no. 37.

⁸ *Cal. Pat.* 1321-4, p. 383.

⁹ Ct. Rolls (Gen. Ser.), portf. 178, no. 45.

¹⁰ *Ibid.* no. 37.

¹¹ The prior and master were accused separately, as if there was no connexion between them, but the master's case was postponed until the lord could be consulted, and nothing was said about it in the later court when the prior made his settlement.

¹² *Cal. Pat.* 1321-4, p. 383.

¹³ Withdrawal of a chantry and alms (Ct. Rolls [Gen. Ser.], portf. 178, no. 37, 39).

In August 1330 Prior Thomas Larchier leased the hospital's manor and the church of Standon to William de Langford for 67½ marks, and as Langford was to receive the brothers coming to the manor,¹⁴ it seems improbable that there was a preceptory here then.¹⁵ Yet if the cell had been given up, it was revived, for in 1358 there are references to the master of the hospital of St. John of Jerusalem at Standon,¹⁶ and in September 1360 to the preceptor of Standon, against whom charges of trespass were then brought.¹⁷

After this nothing more is heard of the preceptory. In the 15th century the rectory and lordship of Standon were let to Ralph Asteley, who in March 1443-4 bequeathed his lease to his sons William and Thomas in equal shares for the term of their lives on condition that they supported the charges on the estate.¹⁸ It was therefore no innovation when in 1505 the knights let the manor and parsonage of Standon and Pagwell to John Kirkby,¹⁹ who had to provide a priest for the chapel of the manor and maintain for two days the steward and surveyor of the Hospitallers coming to hold the manorial courts and transact other business.

The Hospitallers' property here was estimated in 1338 at £34 15s. 4d. a year gross value and £10 15s. 4d. net²⁰; in 1535 its annual value was reckoned at £23 10s.²¹

MASTERS OR PRECEPTORS OF STANDON

Thomas de Bassele, occurs November 1323,²² 1324, and October 1326²³

Thomas Hether, occurs July²⁴ and September 1360²⁵

¹⁴ Cott. MS. Nero, E vi, fol. 120.

¹⁵ The same conclusion might also be drawn from Prior Philip de Thame's report in 1338, that the chaplain at Standon was paid a stipend of 5 marks because he had no board, though the mention of the prior's visitation in the same account might of course be taken to prove the existence of a community (Larking, *The Knights Hospitallers in Eng.* [Camd. Soc.], 89).

¹⁶ Ct. R. (Gen. Ser.), portf. 178, no. 45.

¹⁷ *Ibid.*

¹⁸ Cant. Archiepis. Reg. Stafford. fol. 135 d.-136.

¹⁹ Cott. MS. Claud. E vi, fol. 10. The lease of 1524 (*ibid.* fol. 245 d.) is exactly the same.

²⁰ Larking, *op. cit.* 89-90.

²¹ *Valor Eccl.* (Rec. Com.), i, 403.

²² *Cal. Pat.* 1321-4, p. 383.

²³ Brother Thomas de Bachele is mentioned in the Standon court rolls at these dates, but not called master of the hospital (Ct. R. [Gen. Ser.], portf. 178, no. 37, 38).

²⁴ He is not called preceptor then (*ibid.* no. 45).

²⁵ *Ibid.*

RELIGIOUS HOUSES

HOUSE OF KNIGHTS TEMPLARS

14. PRECEPTORY OF TEMPLE DINSLEY

In a chapter of the Order of the Temple held at Paris in the Octave of Easter 1147,¹ at which Pope Eugenius III was present, Bernard de Balliol gave the knights 'Wedelee,' a member of Hitchin, or land to the value of £15.² This estate, which was at Dinsley,^{2a} was confirmed to them by King Stephen,³ who added two mills with the land and men belonging to them,⁴ and granted them also sac and soc, tol and team and infangtheof, with all other free customs in Dinsley.⁵ At what date the preceptory at Dinsley was founded is not known, but that it was already established at the beginning of the 13th century is certain, since a chapter was held here between 1200 and 1205.⁶ Besides, the agreement of Mabel Abbess of Elstow, c. 1218-22,⁷ to pay the Templars a mark a year and 4 lb. of wax for the maintenance of a chaplain and the light of his chapel at Preston⁸ was apparently later than the arrangement by which the nuns were to find a chaplain to perform divine service three times a week at Preston for the brothers of the Temple living at Dinsley.⁹

The property of the knights in the neighbourhood was increased from time to time,¹⁰ among the larger gifts being 13 acres of land in Wandon in King's Walden,¹¹ and Charlton received in 1244-5 from Maud de Lovetot, formerly the wife of Gerard de Furnival,¹² and 2 marks rent in Welles in Offley^{12a} from John de Balliol.¹³

The Templars in January 1252-3 were granted by Henry III free warren in their demesne lands of Dinsley, Preston, Charlton, Walden and Hitchin.¹⁴

Not much is known about the preceptory, but it was perhaps fairly important. Chapters of the order, besides that already mentioned, were held here c. 1219-29,¹⁵ c. 1254-9,¹⁶ in 1265,¹⁷ 1292,¹⁸ 1301,¹⁹ and 1304,²⁰ and, to judge from evidence given in 1310, on several other occasions.²¹

The preceptor's jurisdiction extended to Baldock, for in 1277 he was summoned to show warrant for hanging a man there.²²

At the time when the Templars were all arrested by the king's order in January 1308 there seem to have been six brothers at Dinsley, since the manor was charged with the maintenance of that number between 14 February and 12 June while they were imprisoned in Hertford Castle.²³ Whether, however, they were resident at Dinsley, and whether they included Richard Peitevyn and Henry de Paul, 'brothers at Dinsley,' who were afterwards sent to the Tower of London,²⁴ is uncertain. There were besides six men then living at Dinsley as pensioners of the house: one who had meals at the squires' table and five who boarded with the brothers.²⁵

After the suppression of the Order of the Temple in 1312 the manor was occupied for some years by the lords of the fee, and then let by them for 27 marks a year to William de Langford, who in 1338 was still the tenant.²⁶ The Knights of St. John had meanwhile become the owners in virtue of the Statute of 1324,²⁷ and eventually placed members of their order

¹⁵ It was held by Alan Marcell (Cott. MS. Nero, E vi, fol. 131 d.), who occurs as master of the Temple at those dates (*V.C.H. Lond.* i, 490).

¹⁶ In the time of Amadeus de Morestello, master of the Temple. On this occasion the Templars granted a messuage in Hitchin for an annual rent payable at their house of Dinsley (Cott. MS. Nero, E vi, fol. 127).

¹⁷ *Cal. Pat.* 1258-66, p. 586.

¹⁸ Wolley Chart. i, 52.

¹⁹ Cott. MS. Nero, E vi, fol. 129.

²⁰ Harl. Chart. 83 C 39.

²¹ Wilkins, *Concilia*, ii, 335, 337, 340-3, 365-6. As a proof that the place was well known, it is perhaps worth noticing that it was given as the scene of more than one of the crimes alleged against the Templars (*ibid.* 361-2).

²² Assize R. 323, m. 41, 6 Edw. I.

²³ L.T.R. Enr. Accts. 18, roll 23.

²⁴ Wilkins, *Concilia*, ii, 347.

²⁵ Two were serving as priests (L.T.R. Enr. Accts. 18, roll 23). A man and his wife also received their food and drink from the preceptory.

²⁶ Larking, *Knights Hospitallers in Eng.* (Camd. Soc.), 172.

²⁷ *Stat. of the Realm* (Rec. Com.), i, 194-5.

¹ The year is not given, but at this chapter arrangements were made for the second crusade (Addison, *The Knights Templars*, 25), which began in 1147.

² Cott. MS. Nero, E vi, fol. 133 d.

^{2a} *V.C.H. Herts.* i, 297; iii, 10.

³ Cott. MS. Nero, E vi, fol. 134, 133 d.

⁴ *Ibid.*

⁵ *Ibid.* fol. 134.

⁶ It was held by Aymeric de St. Maur, master of the Temple, and William de Bernewood, preceptor of London, was present (Madox, *Formulare*, 185). Aymeric appears to have become master in 1200, and William in or before 1205 ceased to be preceptor of London (*V.C.H. Lond.* i, 490).

⁷ *V.C.H. Beds.* i, 357, n. 10.

⁸ Cott. MS. Nero, E vi, fol. 128.

⁹ *Ibid.*

¹⁰ *Ibid.* fol. 125 d., 126, 127, 130, 134.

¹¹ *V.C.H. Herts.* iii, 7, 33.

¹² Cott. MS. Nero, E vi, fol. 133.

^{12a} *V.C.H. Herts.* iii, 41.

¹³ Cott. MS. Nero, E vi, fol. 133.

¹⁴ *Ibid.*

A HISTORY OF HERTFORDSHIRE

there, for the preceptory of Dinsley is mentioned in the reign of Richard II.²⁸

How long this cell was maintained is doubtful. The manor was leased 12 September 1498²⁹ to John Tong, preceptor of Ribston and Mount St. John, for the term of his life at a rent of £26 13s. 4d., Tong undertaking to find a chaplain to perform the religious services for which the lands had been given to the Templars.³⁰ It may, therefore, be concluded that Dinsley had then ceased to be a preceptory. Yet it seems likely that the arrangement marked a new departure and was regarded as temporary, for 9 November 1500 Prior Robert Kendal and the Chapter granted to Robert Shawe, chaplain,³¹ his board in the manor of Dinsley at the table of their gentlemen there, a room and salary of 5 marks to be received from the prior, or from the preceptor, farmer or warden of the manor, and in return Shawe was to perform the services in the chapel as long as he was able.

It is clear, however, that the preceptory was never re-established. The manor was let in 1507 at £26 13s. 4d. a year to Thomas Hobson,

who was to provide the chaplain and maintain for two days and nights the officials sent once or twice a year by the Prior of St. John to survey the property.³² In 1514 it was let on the same terms to Reginald Adyson and his wife Dorothy for fifty years,³³ and their lease becoming void in 1519 through non-payment of the rent, to John Docwra for forty years.³⁴

It is evident, therefore, that beyond a change in the ownership of the land the dissolution of the order of St. John in 1540³⁵ made little difference here.³⁶

The receipts of the Templars' estate at Dinsley from Michaelmas 1311 to Michaelmas 1312 were £82 19s. 9½d.,³⁷ but of this sum the amount derived from rents and profits of court was only £24 12s. 8d. In 1338, as has been said, the manor was let for £18,³⁸ in 1535 it was valued at £29 3s. 4d. a year.³⁹

PRECEPTORS OF DINSLEY

Richard Fitz John, occurs 1255⁴⁰

Ralph de Maltone, occurs 11 June 1301⁴¹

John Dalton, occurs 1380-1⁴² and September 1389⁴³

FRIARIES

15. KING'S LANGLEY PRIORY

The Dominican priory within the royal manor of Langley was founded in 1308¹ by Edward II in fulfilment of a vow made when in peril.² On 1 December the king made the friars a grant of £100 a year until further orders³; on 20 December he gave them his garden near the church and land there for

²⁸ Cott. MS. Nero, E vi, fol. 129, 134 d.

²⁹ Lansd. MS. 200, fol. 54.

³⁰ At an inquisition in 1347 the jurors said that the Hospitallers held the manor of Temple Dinsley of the heirs of former lords of Hitchin, Dinsley Furnival and King's Walden, by the service of finding two chaplains to celebrate in the chapel of the manor for ever for the souls of those who enfeoffed the Templars (Cott. MS. Nero, E vi, fol. 133).

³¹ Lansd. MS. 200, fol. 78. Tong was still farmer of the manor.

¹ Rev. C. F. R. Palmer ('The King's Confessors', *Antiq.* xxii, 159) gives 1307 as the date of foundation, but there seems no mention of the house before 1 Dec. 1308. The friars were probably brought from Oxford. The two houses, at any rate, were closely connected, for in the chapter-general at Pavia in 1423 it was ordained that the government of Langley should chiefly belong to the brothers of the visitation of Oxford, 'who by their sole labour and at their sole expense had caused the priory to be built' (*Cal. of Papal Letters*, vii, 514).

² *Cal. Pat.* 1307-13, p. 453.

³ *Ibid.* 95.

building,⁴ and the next day assigned to them as a dwelling until the priory could be built a place called 'Little London.'⁵ The first prior

³² Cott. MS. Claud. E vi, fol. 51.

³³ *Ibid.* fol. 144 d. On this occasion an inventory was made of the contents of the chapel, among which were 3 mass-books, one new and two old, 3 old graduals in parchment, an old portifory of parchment, a vestment of red camlet with a cross of black damask and Sir John Tong's arms upon it, another vestment of white linen, a cope with Sir John Tong's arms, 8 altar-cloths including one of red tarterine with images of gold thereon with a frontal of the same, 8 curtains of various kinds, 2 canopies, one being of 'cypres bordered with silk with 4 knoppes of red silk,' 3 paxes, one of ivory, a chalice of silver parcel gilt weighing 6 oz., 2 pairs of cruets and a bottle of pewter, a copper cross, a pair of censers and two candlesticks of latten, &c. There were two altars besides the high altar and images of the Virgin Mary and St. John Baptist.

³⁴ *Ibid.* fol. 200, 217.

³⁵ *L. and P. Hen. VIII*, xv, 498.

³⁶ It does not figure in the list of preceptories then (Add. MS. 21315, fol. 59).

³⁷ L.T.R. Enr. Accts. 18, roll 51. Expenses amounted to £40 6s. 6½d.

³⁸ Larking, op. cit. 172.

³⁹ *Valor Eccl.* (Rec. Com.), i, 403.

⁴⁰ Assize R. 320, m. 4.

⁴¹ Cott. MS. Nero, E vi, fol. 129.

⁴² *Ibid.* fol. 134 d. ⁴³ *Ibid.* fol. 129.

⁴ *Cal. Pat.* 1307-13, p. 148; Memo. R. (Exch. L.T.R.), Mich. 9 Hen. V, rot. 9.

⁵ *Cal. Pat.* 1307-13, p. 96.

RELIGIOUS HOUSES

was John de Warefeld, who had for some time belonged to Edward's household,⁶ and in August 1315 became his confessor.⁷

The king in March 1312 gave the brothers 700 marks for building expenses,⁸ and in the summer of that year the conventual church was dedicated and a cemetery consecrated.⁹ Possibly, however, the church was not yet finished, for the body of Piers Gaveston, who was killed about this time,¹⁰ was not buried there until the end of 1314,¹¹ when the ceremony took place with much state, the Archbishop of Canterbury and four bishops as well as many other ecclesiastics taking part in the funeral rites.¹²

In October 1311 the king increased the annual income of the house to £150 to provide for fifteen friars added since the foundation,¹³ so that his grant in September 1312 of 500 marks during pleasure may have been intended for building purposes.¹⁴ He gave the friars in June 1315 a house with closes in his manor of Langley¹⁵ and leave to take wood for fuel and other necessaries from Chipperfield Wood (Chepervillewode).¹⁶ During some years of scarcity he also supplied them with corn.¹⁷

The king, however, felt that this state of dependence on the Exchequer was unsatisfactory, and wished to endow them permanently. To overcome the difficulty that friars-preachers could not own property he proposed to found a house of Dominican nuns,

⁶ Rev. C. F. R. Palmer, *op. cit.*

⁷ *Ibid.*; Wardrobe Accts. (Exch. K.R.), bde. 376, no. 7, fol. 4.

⁸ *Cal. Pat.* 1307-13, p. 453.

⁹ The Bishop of Lincoln's commission to the Bishops of Bath and Ely is dated 29 July 1312 (Linc. Epis. Reg. Dalderby, Memo. fol. 227 d.).

¹⁰ Trokelowe and Blanford, *Chron. et Annales* (Rolls Ser.), 77. His anniversary was kept 18 July (Wardrobe Accts. bde. 376, no. 7, fol. 5).

¹¹ The London Chronicler (*Chron. of reigns of Edw. I and Edw. II* [Rolls Ser.], i, 232) imagined that the church was built by Edward II to receive Gaveston's body.

¹² Trokelowe and Blanford, *op. cit.* 88. For this occasion 23 tuns of wine, price £64, were delivered by the king's butler to John de Becoles, friar of the convent of Langley (Wardrobe Accts. bde. 376, no. 7, fol. 115 d.).

¹³ *Cal. Pat.* 1307-13, p. 397.

¹⁴ *Ibid.* 515. The patent, however, says, 'for their sustenance until the king shall give further order for their status.'

¹⁵ 'The dwelling-place of our manor of Langley' (*ibid.* 1313-17, p. 297). Possibly this is a formal grant of the priory buildings.

¹⁶ *Ibid.* The prior and convent when presented at the manorial court in 1400 for cutting down wood here and selling it claimed to be owners of Chipperfield Wood (Ct. R. [Gen. Ser.], portf. 177, no. 51, m. 3, 7).

¹⁷ *Cal. Close*, 1318-23, p. 70.

who were to hold lands in trust for the brothers, and in 1318 he sent two friars to the pope for his authorization.¹⁸ Robert de Duffeld, the second Prior of King's Langley and the king's confessor, had been dispatched in October 1316 to the master of the order,¹⁹ apparently on the same errand, but nothing was done in the matter for years.

The drawback to allowances is shown in the complaint of the friars to Edward III in 1345²⁰ that owing to the irregularity of the payments from the Exchequer they had not wherewith to live, carry on the works they had begun, and pay their debts. On this occasion, at their request, the money due to the king from the alien priory of Harmondsworth was assigned to them in part payment.

Edward III seems to have been as much interested in the house as his father had been. In 1346 he granted the friars part of a quarry in Shotover for their works,²¹ and in 1347 gave them leave to enlarge the ditch round their close 3 ft. in breadth and 2,000 ft. in length.²² He gave them in April 1358 the fishery of his water of King's Langley with permission to have a weir in that water, and free entrance and exit to and from the weir through his park²³; also the head of a stream in Abbots Langley with leave to dig up his land in making an aqueduct underground to their house.²⁴ In January 1361-2 he gave them, moreover, £20 a year during pleasure to their new work.²⁵ Personal feeling seems to have prompted his grant in 1358 of 4 tuns of wine a year,²⁶ and the gift in 1377 of forty mazers, one of which was called the Edward.²⁷ The wish of Edward II was at last carried out in 1349, and a house of Dominican sisters founded, which, although at Dartford in Kent, was regarded as the complement of Langley priory²⁸; and in December 1356 the prioress and nuns had licence to acquire in mortmain property to the value of £300 for the sustenance of themselves and the friars of King's Langley.²⁹ Here the brothers possibly owed something to the

¹⁸ Rymer, *Foedera* (Rec. Com.), ii, 359-60, 384. He wrote also to the master of the order in 1318, asking him to have seven sisters ready to send when required (*ibid.* 361).

¹⁹ *Cal. Close*, 1307-13, p. 438.

²⁰ Anct. Pet. no. 12196.

²¹ *Cal. Pat.* 1345-8, p. 45.

²² *Ibid.* p. 428.

²³ Pat. 32 Edw. III, pt. ii, m. 19.

²⁴ *Ibid.* m. 20.

²⁵ *Ibid.* 37 Edw. III, pt. ii, m. 37.

²⁶ *Cal. Pat.* 1358-61, p. 30. The quantity was unusually large as judged from the wardrobe accounts.

²⁷ Pat. 51 Edw. III, pt. i, m. 23.

²⁸ The pope's confirmation was asked in Nov. 1349 (*Cal. Papal Pet.* 187).

²⁹ *Cal. Pat.* 1354-8, p. 486.

A HISTORY OF HERTFORDSHIRE

influence of John Woderowe, the king's confessor, who in June 1356 is mentioned as their prior.³⁰

Still, the foundation of Dartford for some time did not change materially the financial position of Langley. The king in October 1363 granted to the convent of twenty brothers 200 marks a year of his alms—viz., to each friar 100s. for his maintenance and 33s. 4d. for clothing,³¹ and in March 1371 ordered that the money should be paid to them from the issues of the alien priory of Burstall.³²

But the appropriation of the church of Langley in 1374 to the nuns of Dartford³³ is the beginning of a new arrangement. In October 1376 Edward III made over to John Duke of Lancaster, Simon Archbishop of Canterbury, and others in trust for the convent at Langley the hundred and manor of Preston and the manors of Overland in Ash, Elmstone, Wadling in Ripple, Packmanstone in Newchurch, Harrietsham, 'Godmeston,'³⁴ Beaurepaire, Waldeslade in Chatham, Ham and Westgate in the Isle of Thanet, co. Kent,³⁵ and these were granted to the friars from Easter 1382 for forty years,³⁶ with the idea that during this term they might be secured to them in frankalmoign.³⁷ The convent let them to Simon de Burley, who shortly afterwards received a grant of them in fee simple from Richard II.³⁸ The brothers in 1383-4 represented to the king that the rent was much in arrears, and begged that King Edward's intention might be fulfilled and the lands given to them in mortmain³⁹; but this was not done, for in September 1386 the king assigned to them the farm of the alien priory of Ware instead of the manors held by Burley.⁴⁰ After Burley's execution and forfeiture in 1388 the friars were allowed possession of the property pending inquiry into the king's right, but complained that they and their sureties were harassed by the Exchequer, while large sums due from Burley were still owing.⁴¹ The desired Letters Patent were not,

however, granted until 24 April 1399, when the king considering that the house of King's Langley 'was not yet sufficiently built and endowed, and as the foundation required,' gave the manors to the nuns of Dartford in frankalmoign to hold for the friars.⁴² Five years earlier they had acquired in the same way from Richard II the advowson of Willian, co. Herts.,⁴³ and from John Waltham, Bishop of Salisbury, and Warin Waldegrave that of Great Gaddesden,⁴⁴ co. Herts., with leave in both cases to appropriate the churches to their own uses.

When Richard died in February 1400 he was at first buried at Langley priory⁴⁵; afterwards, however, his body was removed by order of Henry V to Westminster Abbey.⁴⁶ But the conventual church of Langley still retained a sign of the priory's connexion with the royal family in the tomb of Edmund of Langley, Duke of York, interred here in 1402 beside his wife, the daughter of Peter, King of Castile.⁴⁷

Henry IV in 1399⁴⁸ and Henry V in 1413⁴⁹ confirmed the grants made to the friars, who therefore could easily prove their title to the Kentish manors, when the escheator seized them in 1420 on the expiration of the term for which they had originally been given.⁵⁰ The experience showed the expediency of royal confirmations, and the prior and convent obtained the ratification of their charters from Henry VI in 1424,⁵¹ Edward IV in 1466,⁵² Henry VII in 1486, and in 1510 from Henry VIII.⁵³

The house seems to have been now provided with an income, not only assured but sufficient. The certain livelihood it offered is said to have been the reason why Richard Wycherley, a former prior promoted to be Bishop of 'Olivence,' asked to be appointed prior again about 1497, and this time for life.⁵⁴ He promised that he would live under the obedience

⁴² Memo. R. (Exch. L.T.R.), Mich. 9 Hen. V, rot. 10.

⁴³ The king had received the advowson from Robert Braybrook, Bishop of London, on condition that the church should be appropriated to the nuns (*ibid.*).

⁴⁴ They had acquired the advowson from the Earl of Huntingdon, the king's half-brother (*ibid.*).

⁴⁵ 'Annales Ric. II et Hen. IV' in Trokelowe and Blaneforde, *op. cit.* 331; Devon, *Issues of the Exch.* 276.

⁴⁶ Trokelowe and Blaneforde, *op. cit.* 326-7. The king gave the brothers £22 on this occasion.

⁴⁷ *Ibid.* 344.

⁴⁸ *Cal. Pat.* 1399-1401, p. 59.

⁴⁹ *Ibid.* 1413-16, p. 139.

⁵⁰ Memo. R. (Exch. L.T.R.), Mich. 9 Hen. V, rot. 9.

⁵¹ *Cal. Pat.* 1422-9, p. 263.

⁵² *Ibid.* 1461-7, p. 556.

⁵³ Memo. R. (Exch. L.T.R.), Hil. 9 Hen. VIII, rot. 15.

⁵⁴ Early Chan. Proc. bdlc. 266, no. 2.

³⁰ *Cas. Pat.* 1354-8, p. 444.

³¹ Pat. 37 Edw. III, pt. ii, m. 37.

³² *Ibid.* 45 Edw. III, pt. i, m. 26. To leave something for general expenses, the allowance for clothing was now reduced to 20s.

³³ Linc. Epis. Reg. Buckingham, Inst. pt. i, fol. 306.

³⁴ This may be Goodneston, but Hasted (*Hist. of Kent*, iii, 703) does not mention any property here belonging to Langley Priory.

³⁵ *Parl. R.* iii, 60-1, 180b.

³⁶ Memo. R. (Exch. L.T.R.), Mich. 9 Hen. V, rot. 9.

³⁷ Anct. Pet. no. 991, printed in *Parl. R.* iii, 180b.

³⁸ *Ibid.*

³⁹ *Ibid.*

⁴⁰ *Cal. Pat.* 1385-9, p. 213.

⁴¹ Anct. Pet. no. 12488.

RELIGIOUS HOUSES

of the provincial, enrich the house with his own possessions, require only the same living as priors usually had, and render due account of the revenues of the priory. The post was given to him, but according to the story of his successor the appointment was not to the convent's benefit: after four years of office he was £64 in debt to the house. In his last illness he desired that the sum should be paid, and in further recompense of charges on the priory caused by his episcopal dignity he bequeathed to the convent his crozier and mitre worth £40. After his death his executors sued the prior and convent for some of his property—viz., a silver ewer and holy water stock,⁶⁵ a counterpane and a dozen napkins. The friars declared that they belonged to the house, and the bishop had them in pledge, and asked that the trial of the case in Worcestershire might be stopped as detrimental to their interests. The friars may have been wronged, but it must be owned that their tale is not very plausible, for it is unlikely that they would pawn goods to a person in their debt.

The house was subjected to an attack on its rights and property from — Verney in 1533, when Cromwell showed himself disposed in their favour.⁶⁶ Richard Yngworth,⁶⁷ the prior, on 16 December⁶⁸ sent him a present of apples, and thanked him for his help and counsel to the provincial (Hilsey), by which he himself was enabled to serve God quietly and keep his study and office without trouble. Verney several months later was still causing the convent annoyance and loss, but the prior would not take steps against him without Cromwell's leave.⁶⁹ Yngworth's attitude here expresses his policy, which was complete subservience to Cromwell, naturally for his own advancement. In April 1534 he went on a visitation to the eastern counties to secure the acknowledgement by the friars of the king's claim to be supreme head of the English Church,⁶⁰ and later made himself useful to Hilsey elsewhere in the same business.⁶¹ The convent at Langley,

needless to say, made the formal declaration required.⁶²

Yngworth's labours were not unnoticed. When Hilsey was made Bishop of Rochester,⁶³ Thomas Bedell wrote to Cromwell recommending that the Prior of Langley, 'who had taken great pains in the king's matters,' should have the office of provincial⁶⁴; Russell also urged his appointment.⁶⁵ The post, however, was not vacant, and Yngworth had to wait for preferment until December 1537, being then made Suffragan Bishop of Dover.⁶⁶ Probably he ceased to be Prior of King's Langley from that time.⁶⁷ He was commissioned by the king in February 1538 to visit all friaries in England,⁶⁸ and in May he was ordered to put their goods into safe custody and take inventories of them,⁶⁹ evidently in preparation for suppression. Langley was surrendered towards the end of that year.⁷⁰ Many of the friars were very old and poor,⁷¹ but it is doubtful whether any provision was made for them. Yngworth begged for the house immediately,⁷² and in February 1540 it was granted to him with most of its lands, to be held until he obtained ecclesiastical benefices worth £100 a year.⁷³ The priory was reckoned in the Valor of 1535 as worth £122 4s. a year clear,⁷⁴ a fairly accurate estimate, to judge from the statement at the Dissolution.⁷⁵ Its gross annual value was then said to be £130 16s. 8d., but to this must be added £11 13s. 4d. for the obits of Sir John Cheyne and Sir Ralph Verney, so that its net income after the deduction of £18 6s. 8d. for salaries and other payments was £124 3s. 4d.

It is impossible to ascertain the size of the convent at any period. Edward II intended the house to hold a hundred,⁷⁶ but there is no proof that it ever did. His allowance of £50 extra for fifteen brothers in 1311⁷⁷ implies that there were then forty-five here. Edward III in 1356 gave licence to the nuns of Dartford to acquire land sufficient to maintain forty sisters and sixty friars,⁷⁸ but the number he actually

⁶⁵ Valued at £4 and £5 respectively.

⁶⁶ Christopher Hales wrote to Cromwell, 1 Jan. 1534: 'The Prior of King's Langley tells me you have been very good master to him, in which I think you do well. I know neither the place nor his adversary, but I have seen several of his charters, showing that former kings have been good to the house, and I see no reason why such an officer as Mr. Verney should do them wrong' (*L. and P. Hen. VIII*, vii, 11).

⁶⁷ His name is not mentioned, but there is no doubt that he was prior then.

⁶⁸ *L. and P. Hen. VIII*, vi, 1532.

⁶⁹ Hilsey's letter to Cromwell (*L. and P. Hen. VIII*, ix, 1154). As Hilsey was then Bishop of Rochester the date cannot be earlier than August 1535.

⁷⁰ *Ibid.* vii, 595.

⁷¹ *Ibid.* 939; ix, 373.

⁶² *L. and P. Hen. VIII*, vii, 665 (2).

⁶³ August 1535.

⁶⁴ *L. and P. Hen. VIII*, ix, 373. ⁶⁵ *Ibid.* 598.

⁶⁶ *Ibid.* xii (2), 1311 (13).

⁶⁷ Palmer says he was prior until 1537. 'Prelates of the Black Friars of England' (*Antiq.* xxvii, 114).

⁶⁸ *L. and P. Hen. VIII*, xiii (1), 225.

⁶⁹ *Ibid.* 926.

⁷⁰ *Ibid.* xiii (2), 1021. The account of the house, dated 10 Dec. 1538, seems to have been drawn up very soon after the Suppression (*ibid.* 1022).

⁷¹ *Ibid.* 1022. ⁷² *Ibid.* xiv (1), 348.

⁷³ *Ibid.* xv, 1032, p. 542.

⁷⁴ *Valor Eccl.* (Rec. Com.), iv, 276.

⁷⁵ *L. and P. Hen. VIII*, xiii (2), 1022.

⁷⁶ *Cal. Papal Pet.* 1342-1419, p. 187.

⁷⁷ *Cal. Pat.* 1307-13, p. 397.

⁷⁸ *Ibid.* 1354-8, p. 486.

A HISTORY OF HERTFORDSHIRE

provided for at Langley from the Exchequer did not exceed twenty, apparently increased by twenty under his will.⁷⁹

The priory of King's Langley was refounded by Philip and Mary in June 1557⁸⁰ as a house of Dominican sisters, at the request, and for the benefit of seven nuns, formerly at Dartford. The prioress and convent were declared a corporate body, having perpetual succession and power to acquire property and to sue and be sued at law. They were given the house and site of the late friary,⁸¹ the land called 'le Courte Wike' in King's Langley which had belonged to the priory, and a house and buildings within 'the old manor' lying near the pales of the royal park.

On 8 September 1558⁸² the king and queen granted to the Prioress and convent of Langley the reversion of certain tenements in Dartford, formerly demesne lands of the nuns of that place, and until the expiration of the lease, the rent of £30 7s. 7d. They gave also, besides other demesne lands, the house of the late nunnery with the property in Dartford assigned after its suppression to Anne of Cleves, and it has been supposed⁸³ that the nuns now returned to Dartford. In any case, the convent's existence was very short. Queen Mary died in November of that year, and by an Act passed in Elizabeth's first Parliament all restorations or foundations of monasteries since the death of Edward VI were made void, and their possessions given to the Crown.⁸⁴

Elizabeth Cressener⁸⁵ was the only prioress.

PRIORS OF KING'S LANGLEY

John de Warefeld, 1308-15⁸⁶
 Robert de Duffeld, appointed 1315,⁸⁷ occurs
 October 1316⁸⁸ and 1319⁸⁹
 Roger de Woderowe, occurs 1329 and 1340⁹⁰
 John de Dunstable, died c. 1343⁹¹

⁷⁹ Nichols, *Royal Wills*, 60.

⁸⁰ Pat. 3 & 4 Phil. and Mary, pt. vii, m. 23. Cardinal Pole instituted the nunnery at the wish of the king and queen.

⁸¹ From the report on the place in 1554-5 (Aug. Off. Misc. [Exch. Q.R.], bdle. 83, no. 13) the priory was habitable.

⁸² Pat. 5 & 6 Phil. and Mary, pt. iii, m. 20.

⁸³ Rev. C. F. R. Palmer, 'Prelates of the Black Friars of England,' *Antiq.* xxvii, 114.

⁸⁴ Stat. 1 Eliz. cap. 24. Palmer says the house was suppressed July 1559.

⁸⁵ Pat. 3 & 4 Phil. and Mary, pt. vii, m. 23.

⁸⁶ Rev. C. F. R. Palmer, 'Prelates of the Black Friars of England,' *Antiq.* xxvii, 114.

⁸⁷ *Ibid.*

⁸⁸ *Cal. Close*, 1307-13, p. 438.

⁸⁹ Rev. C. F. R. Palmer, 'The King's Confessors,' *Antiq.* xxii, 159.

⁹⁰ Rev. C. F. R. Palmer, 'Prelates of the Black Friars,' *Antiq.* xxvii, 114.

⁹¹ *Ibid.*

John Woderowe, occurs 9 June 1356⁹²

Thomas Walsh, occurs 1374⁹³

John, occurs October 1384⁹⁴

William Syward, occurs January 1394-5⁹⁵

Philip Boydon, occurs 1426⁹⁶

John Henle,⁹⁷ removed before May 1427⁹⁸

John de Hunden, D.D., resigned in 1458 on becoming Bishop of Llandaff⁹⁹

William Wignale, S.T.D., occurs 16 July 1458¹⁰⁰

Thomas Welles, occurs 14 July 1466¹

Richard Wycherley, resigned on becoming Bishop of 'Olivence'²

Thomas Powel or Poynes, occurs 1494³-c. 1498⁴

Richard Wycherley, Bishop of 'Olivence,' appointed 1498-9, died c. 1502-3⁵

Robert, occurs c. 1502-3⁶

Thomas Cowper, S.T.B., occurs 1519⁷

Robert Mylys or Miles, occurs 1522⁸

Richard Yngworth, S.T.P., occurs 1530⁹ and December 1537¹⁰

A 15th-century seal of the house,¹¹ in shape a pointed oval, bears a representation of the Annunciation in a niche of very elaborate design, below which the royal founder kneels in prayer. On either side of him is a shield not of the arms of Edward II, but of France and England. Of the legend only two letters survive.

A later seal,¹² also a pointed oval, represents our Lord in majesty. In the base, under a carved four-centred arch, is the king as in the earlier seal. The inner border is

⁹² *Cal. Pat.* 1354-8, p. 444.

⁹³ Rev. C. F. R. Palmer, 'Prelates of the Black Friars,' *Antiq.* xxvii, 114.

⁹⁴ Ct. R. (Gen. Ser.), portf. 177, no. 47.

⁹⁵ *Ibid.* no. 49. He was Prior of London in 1382 (*V.C.H. Lond.* i, 502) and vicar-general of the order in England in 1387 (Chan. Warr. [Ser. 1], file 175, no. 7).

⁹⁶ He ceased to be prior then (*Antiq.* xxvii, 114).

⁹⁷ He succeeded Boydon (*Antiq.* loc. cit.).

⁹⁸ *Cal. Papal Letters*, vii, 514.

⁹⁹ *Antiq.* xxvi, 212.

¹⁰⁰ Add. Chart. 27339.

¹ *Cal. Pat.* 1461-7, p. 556.

² Early Chan. Proc. bdle. 266, no. 2.

³ *Antiq.* xxvii, 114.

⁴ Early Chan. Proc. bdle. 266, no. 2.

⁵ *Ibid.* He rendered his accounts 17 Hen. VII, i.e., 1501-2, after holding office four years, and must have died shortly afterwards, since his successor Robert petitioned the chancellor on the subject of his executors in 1502-3.

⁶ *Ibid.*

⁷ *Antiq.* loc. cit.

⁸ *Ibid.*

⁹ B.M. Seals, xlv, 41.

¹⁰ *L. and P. Hen. VIII*, xii (2), 1156.

¹¹ B.M. Seals, lxiv, 69.

¹² *Ibid.* xlv, 40.

RELIGIOUS HOUSES

engrailed. Legend: SIGILLUM : COMUNE : FRATRUM : PREDIC : DE : LANGELEYE.

A 16th-century seal,¹³ of the same shape but slightly larger, shows the coronation of the Virgin in a niche with two-arched canopy. On each side there is a smaller canopied niche; the one on the left containing St. Margaret, crowned, standing on the dragon, which she pierces with a long cross, and holding in her right hand a book; in that on the right is an archbishop with mitre and crozier. Below is the founder on his knees under a carved round-headed arch; he holds a church and in front of him on the ground is his crown. Legend: . . . VENT . MONAST'II DE LAN . . Y. The counterseal shows two impressions of a shield-shaped signet with arms, a bend engrailed between six fleurs de lis with three crosslets fitchy on the bend, the ownership of which is unknown.

16. THE FRIARS MINORS OF WARE

The Franciscan priory of Ware owed its foundation to Thomas second Lord Wake of Liddell, who received the king's permission in February 1338 to give to the Friars Minors a messuage and 7 acres of land in Ware for an oratory, houses and other buildings.¹⁴ In September 1350 the pope confirmed the acceptance of the site by the minister-provincial and Friars Minors in England.¹⁵ Land for the enlargement of the priory was granted to the friars in 1372 by Blanche Lady Wake.¹⁶ For their maintenance the community depended mainly on alms. They thus came into collision with the Franciscans of Cambridge, on whose complaint they were forbidden by the pope in August 1395 to extend their bounds for begging and preaching within 5 miles of any place, except Puckeridge, which before their house was founded had belonged to the district of the Cambridge friars.¹⁷

Henry IV, after the death and forfeiture of Thomas Holland Earl of Kent, allowed them the underwood of an acre of wood near Ware, two cartloads of hay from the meadows there, and the fishery of the water along the priory during such time as the late earl's property remained in his hands.¹⁸

¹³ B.M. Seals, xlv, 38, 39.

¹⁴ *Cal. Pat.* 1338-40, p. 14. Weever, Chauncy and others, confusing it with the alien priory, dated its foundation far too early (R. Waters, 'Priory of Ware,' *East Herts. Arch. Soc. Trans.* i [1], 41).

¹⁵ *Cal. of Papal Letters*, iii, 394; Wadding, *Annales Minorum*, viii, 75.

¹⁶ *Pat.* 46 Edw. III, pt. ii, m. 32.

¹⁷ *Cal. of Papal Letters*, iv, 517.

¹⁸ *Cal. Pat.* 1399-1401, p. 226. The Earl of Kent was the heir of the Wakes through his grandmother Joan, Princess of Wales. The friars probably enjoyed these privileges under the Wakes and Hollands.

They must have derived some advantage from burials in their church,¹⁹ from legacies²⁰ and probably from obits, though only one is recorded, that of Thomas Hyde, established in 1525.²¹ But the house must always have been small and poor, and its obscurity was perhaps the reason why Roger Donwe or Dewe, the minister-provincial, removed for just causes in 1430,²² was sent here to end his days.²³

The royal supremacy was duly acknowledged by the convent in May 1534.²⁴ The warden seems to have been friendly with Lord Hussey in 1537,²⁵ but there is no evidence to connect him with the religious troubles. The surrender of the priory took place in the autumn of 1538.²⁶ Its lands, including the site,²⁷ were worth only 29s. 8d. a year.

WARDENS OF THE FRIARS OF WARE

Paul, occurs 3 October 1525²⁸

Thomas Chapman, S.T.B., occurs 5 May 1534²⁹

The contemporary seal³⁰ is a pointed oval. On the right kneels the founder, Lord Wake, in armour, with a shield of his arms; opposite to him is his wife, Blanche of Lancaster. The object of their adoration seems to be the Crucified. The field is powdered with stars; there is a little tree between the two worshippers and a larger one at each side. Below, under a four-centred arch, the warden is represented in prayer. Legend: s' GARDIANI (FRATRVN) MINORVM DE WARE.

17. THE CARMELITE FRIARS OF HITCHIN

The Carmelite priory of St. Mary in Hitchin was founded in 1317, apparently by Edward II,

¹⁹ Weever (*Antient Funeral Monum.* 312) records two or three burials here.

²⁰ Elizabeth de Burgh, Lady Clare, bequeathed them 40s. in 1355 (Nichols, *Royal Wills*, 23, 33); and they are mentioned in other wills (*Herts. Gen. and Antiq.* i, 47, 316 [2], 318; ii, 91 [2], 238; iii, 274; P.C.C. 21, Bodfelde; 22, Porch).

²¹ Add. Chart. 36070.

²² Wadding, op. cit. x, 169.

²³ *Monum. Francis.* (Rolls Ser.), i, 539; Little, *The Grey Friars in Oxford*, 259.

²⁴ *L. and P. Hen. VIII*, vii, 665 (2).

²⁵ *Ibid.* xii (2), 2 (3); 157 (2).

²⁶ The Bishop of Rochester wrote to Cromwell 27 Sept. 1538 offering to bring about its surrender (*ibid.* xiii [2], 437), which was made, however, to the Bishop of Dover (*ibid.* 1021). It seems to have been in the king's hands about Michaelmas 1538 (Mins. Accts. Hen. VIII, no. 1617).

²⁷ Rented at 20s. (Mins. Accts. Hen. VIII, no. 1617).

²⁸ Add. Chart. 36070.

²⁹ *L. and P. Hen. VIII*, vii, 665 (2).

³⁰ B.M. Seals, lxiv, 73.

A HISTORY OF HERTFORDSHIRE

who on 8 June gave to friars of that order a messuage there which he had of the grant of Adam le Rous, that they might build a church and house.³¹ In February 1351 John de Cobham received the king's permission to assign to the convent two messuages, two cottages, and 6 acres of land to enlarge their dwelling-place.³² Cobham seems to have taken some time to complete his gift: in fact, half an acre of the land was made over to them as late as 1375, and was in consequence seized by the escheator in 1392 as acquired without the royal licence, the friars not recovering it until 1395.³³

Beyond a few references in wills³⁴ nothing is heard of the house during the 15th century.

Henry VIII in September 1530 made the friars a gift of 40s.³⁵ The royal supremacy was acknowledged by the prior for the convent on 5 May 1534,³⁶ and the house lasted four years longer. Then the king, finding, so he said, that it was 'in such a state that it was neither used to the honour of God nor to the benefit of the commonwealth,' directed Sir William Coffyn and Henry Crwche to obtain its surrender from the prior, allotting him what portion of the goods they thought fit.³⁷ The surrender was made 17 October 1538 by the prior and four friars.³⁸ The plate and ornaments were sold, and the church, of which the steeple was knocked down, was stripped of its bells, lead, glass and stone, and soon fell into ruins.³⁹

The property of the convent, valued in 1535 at £4 9s. 4d. a year net,⁴⁰ lay in or near Hitchin.⁴¹

³¹ *Cal. Pat.* 1313-17, p. 662; Tanner, *Notit. Mon.* Chauncy says (*Hist. of Herts.* 390) that John Blomvill, Adam Rous and John Cobham founded the priory which was dedicated to the honour of our Saviour and Blessed Virgin Mary, and Edward II merely confirmed the grant. Adam Rous may have given the land to the king for the site of the house, and John Cobham later was a great benefactor, but as the editors of Dugdale point out (*Mon.* vi, 1571) the coats of arms of Edward II and Edward III on the priory seal show that the house was considered a royal foundation. With regard to the dedication, Chauncy seems to have confused this with the Gilbertine priory, for it is unlikely that both were called St. Saviour's.

³² Inq. a.q.d. file 303, no. 12; *Cal. Pat.* 1350-4, p. 48.

³³ Memo. R. (Exch. L.T.R.), East. 18 Ric. II, rot. 3; Mich. 19 Ric. II, rot. 6.

³⁴ *Herts. Gen. and Antiq.* i, 234, 236-7; ii, 90, 190, 276; iii, 238; Add. Chart. 35245.

³⁵ *L. and P. Hen. VIII*, v, p. 751.

³⁶ *Ibid.* vii, 66; (2).

³⁷ Clutterbuck, *Hist. and Antiq. of Herts.* iii, 20.

³⁸ *Ibid.* The house was dissolved the next day (Rentals and Surv. [Gen. Ser.], portf. 8, no. 29).

³⁹ Rentals and Surv. (Gen. Ser.), portf. 8, no. 29. Report on the property in 1546.

⁴⁰ *Valor Eccl.* (Rec. Com.), iv, 276.

⁴¹ Rentals and Surv. (Gen. Ser.), portf. 8, no. 29.

PRIORS OF HITCHIN FRIARY

John, occurs October 1395⁴²

John Butler, occurs 5 May 1534⁴³ and 17 October 1538⁴⁴

The priory seal of the 16th century⁴⁵ shows the Virgin seated with the Child standing on her knee; in the field on each side of her is a flowering branch. Right and left are two shields, the former bearing the arms of Edward III, the latter those of Edward II, and beneath each is a kneeling friar. Legend: s' cōITATIS FRA' CAR MALITAR' DE HVCHE.

18. THE TRINITARIAN FRIARS OF HERTFORD

Who founded the hospital of St. Mary Magdalene outside Hertford, afterwards a Trinitarian Friary, is not known, but it was in all probability one of the earlier owners of Hertingfordbury Manor,⁴⁶ possibly one of the Valognes, whose heiress Christina wife of Peter de Maule or Maune⁴⁷ held the advowson⁴⁸ in 1247 and sold it then to Henry de Neketon. The master of the hospital at one time was accustomed to receive a rent of 20s. from Christina de Valognes's water-mill in Hertingfordbury,⁴⁹ presumably the gift of a former lord of the manor. It is also noticeable that the hospital among its small amount of property held in 1263 a rent of 9s. from land in Roydon, co. Essex,⁵⁰ where Robert Fitzwalter, the husband of Gunnora de Valognes, Christina de Maule's predecessor at Hertingfordbury, had had a manor.⁵¹

In 1248 Simon de Cokham, a citizen of London, complained that the master and brothers of the hospital had dispossessed him of 80 acres of land in Stanstead which they had let to him for eight years from February 1247 at an annual rent of 12 marks.⁵² The

⁴² Memo. R. (Exch. L.T.R.), Mich. 19 Ric. II, rot. 6.

⁴³ *L. and P. Hen. VIII*, vii, p. 751.

⁴⁴ Clutterbuck, op. cit. iii, 20. He was living in 1546 (Rentals and Surv. [Gen. Ser.], portf. 8, no. 29).

⁴⁵ *Arch.* xviii, 447.

⁴⁶ Ralph Baynard held it at the Domesday Survey (*V.C.H. Herts.* i, 326).

⁴⁷ An arrangement was made in 1238 about their fine for the barony which had belonged to Gunnora de Valognes (*Excerpta e Rot. Fin.* [Rec. Com.], i, 317).

⁴⁸ Feet of F. Herts. 31 Hen. III, no. 332; Assize R. 320, m. 12. When Hertingfordbury was made over to Edward III, the patronage of the hospital or priory of Hertford, as it was sometimes called, was specially excepted (*Cal. Pat.* 1345-8, p. 123).

⁴⁹ Christina bought the rent of him shortly before Nov. 1279 (Chan. Inq. Misc. file 37, no. 6).

⁵⁰ *Cal. Inq. p.m.* Hen. III, 163.

⁵¹ *Ibid.* 2.

⁵² Assize R. 318, m. 2 d.

RELIGIOUS HOUSES

master could not deny the agreement or its non-observance, and was ordered by the court to pay damages and a fine, but was afterwards pardoned the one because he had sowed the land and the other on account of his poverty.

In 1255 Avelina wife of Geoffrey le Clerk sued Walter, the warden of St. Mary Magdalene, for withdrawing the corrody⁵³ granted to her for life by a former warden, William Peverel.⁵⁴ Walter's plea was that the wardens, who were removable by the patron, could not make any valid charter without his consent. It was proved, however, that William and his predecessors had let their lands as they chose, and that masters of the hospital had often granted corrodies similar to that given to Avelina, who accordingly recovered hers.

Avelina and her husband⁵⁵ in 1263 sold to Robert, prior of the hospital, 40s. rent in Hertford.

As the hospital of St. Mary Magdalene was in the hands of friars of the Holy Trinity in 1287,⁵⁶ there can be no doubt that it was the leper-house outside Hertford, of which brothers of the Trinitarian order had taken possession about 1261⁵⁷ after removing the lepers.⁵⁸

The hospital appears to have been under the direction of the head of the friary at Easton,⁵⁹ and it is interesting to notice that Prior Robert's attorney in 1263 was a certain brother Robert de Eston. Houses under the Maturine rule were always dedicated to the Trinity,⁶⁰ and after 1287 the hospital of St. Mary Magdalene is heard of no more. As the

hospital of Holy Trinity it was receiving a rent of 10s. from a water-mill in Hertingfordbury in 1355, 1360⁶¹ and 1383-4,⁶² and at the last date is mentioned as holding a fair,⁶³ half the tolls of which it paid to the king's bailiff of Hertford. There was apparently still a community here in 1448, when the chamberlain and warden of 'the hospital of the poor of the Trinity and St. Thomas the Martyr' at Hertford admitted Walter Devereux and his wife Ann to the benefits of the order and of masses in the hospital.⁶⁴

How much longer it lasted as a religious house is uncertain. A bequest to 'the chapel of the Trinity in Hertford' in 1504⁶⁵ does not necessarily imply that the friary was then no longer in existence, though it probably came to an end some years before the general Dissolution, for it was described when granted to Anthony Denny in 1540 as a 'messuage' called le Trynytie in Hertford formerly belonging to the Crossed Friars in Mottenden.⁶⁶

Its property consisted of 10 acres of arable land in the common fields, half an acre of meadow and a close called 'le Freres Crofte' in Hertford, 10 acres in Dixwell, 4 acres in Hatfield, and 6 acres of wood in Amwellbury,⁶⁷ where 5 acres had been acquired in 1300 by the friars of Easton.⁶⁸

Nothing is said of the rent in Roydon, co. Essex, or of the land at Stanstead.

WARDENS OF HERTFORD

William Peverel, occurs before 1255⁶⁹
Walter, occurs 1255⁷⁰
Robert, occurs 1263⁷¹
William, occurs April 1287⁷²

⁵³ A brother's allowance and feed for a horse during four months of the year.

⁵⁴ Assize R. 320, m. 15.

⁵⁵ Here called Geoffrey de Horemewe (Feet of F. Herts. 47 Hen. III, no. 571).

⁵⁶ *Cal. Pat.* 1282-91, p. 267.

⁵⁷ *Hund. R.* (Rec. Com.), i, 194. The lepers are also mentioned in a rental of the monks of Hertford (B.M. Chart. L.F.C. x [14]) as follows: 'from the lepers of the hospital of Hertford 8*d.* viz. 4*d.* for ½ ac. of land given them by Ralph son of Chapman which lies in Middelfeld and 4*d.* for land in Middelfeld given them by Reyner Holman.'

⁵⁸ The revenue of Trinitarian houses was divided into three parts and devoted to the support of the friars, the relief of the poor and the redemption of Christians taken captive by infidels (Dugdale, *Mon.* vi, 1558). The leper hospital was probably brought to an end by financial straits, which are indicated in the cases cited above.

⁵⁹ Presumably Easton (co. Wilts.), where there was a house of Trinitarians, though it is difficult to understand such an arrangement when there was a much nearer friary at Hounslow.

⁶⁰ Dugdale, loc. cit.

⁶¹ Mins. Accts. bdle. 865, no. 17, 18.

⁶² Ibid. bdle. 53, no. 998.

⁶³ As the fair was held on the feast of St. Mary Magdalene it was probably not of recent grant.

⁶⁴ *Hist. MSS. Com. Rep.* iii, App. 251.

⁶⁵ Will of Sir Robert Watson, clerk (P.C.C. 4 Holgrave).

⁶⁶ Pat. 32 Hen. VIII, pt. iii, m. 1. Mottenden in the parish of Headcorn (Kent) was the head house in England of the Maturine brothers, here called Crossed Friars because they wore a cross on their gowns. The Trinitarians, of course, are not the same as the Crossed or Crutched Friars, one of the four great orders of Mendicant Friars.

⁶⁷ Ibid.

⁶⁸ Inq. a.q.d. 29 Edw. III, file 35, no. 10.

⁶⁹ Assize R. 320, m. 15.

⁷⁰ Ibid.

⁷¹ He is called prior (Feet of F. Herts. 47 Hen. III, no. 571).

⁷² He is called minister, as the Maturine rule required (*Cal. Pat.* 1282-91, p. 267).

COLLEGIATE HOUSE

19. COLLEGE OF THELE OR STAN- STEAD ST. MARGARET'S

The rectory of St. Margaret's, Thele, is said to have grown so poor that at the beginning of the 14th century it was becoming almost impossible to find a priest to accept the living.¹ It was in these circumstances that Sir William Goldington, the patron, the better to provide for divine worship, established in the church at the altar of St. Mary a chantry of five chaplains² which he endowed in May 1316³ with a messuage, a carucate of land, 8 acres of meadow, 15 acres of wood and £10 rent in Thele, Amwell and Bowers Gifford, pasturage for six cows and 100 sheep in his demesne lands in Thele, and the advowsons of the churches of Thele and Aldham^{3a} (Essex), with leave to appropriate them to their own uses.

The rectors of Thele and Aldham having resigned, Gilbert Bishop of London agreed to appropriate the churches to the college on condition that a vicarage should be ordained at Aldham and that the Bishop of London should present the vicar of Aldham and the warden of the college, who was to have cure of souls at Thele; his choice, however, was to be restricted to members of the college, vacancies in whose ranks were to be filled up by Goldington and his heirs.⁴ The bishop died before he could carry out his intentions, but his successor, Richard, in August 1317⁵ completed the appropriation and laid down certain rules for the chaplains: they were to say all the hours and were to celebrate five masses daily, one of St. Mary, another of the day which was to be sung, and three others for the dead in a low voice; they were to live together in obedience to the warden and at service were to wear black.⁶

In 1348 Philip de Aungre and his wife Alice gave the college three messuages and some land in Chelmsford and Broomfield, co. Essex, towards the maintenance of a chaplain to cele-

brate for them daily,⁷ and Alice the next year bequeathed to them a place in the parish of St. Bartholomew the Less, London.⁸ The chaplains also obtained in 1353 land in Amwell, Stanstead and Hoddesdon⁹ in part satisfaction of land and rent to the value of 100s., which in 1346 they had received the king's permission to acquire.¹⁰

The college came to an end in 1431, after an existence of a little over a century.¹¹ It was alleged by the Bishop of London, in his request for the royal consent to its dissolution and the transfer of its property to Elsingspital, London, that much of its property had been alienated through the carelessness, neglect, and ill-governance of the wardens, and for want of the defence of pleas often brought against them,¹² and the rest would probably soon be lost, unless a remedy were provided. Yet, on comparing what they then possessed with the grants made to them, the difference is not striking. Probably the condition of the college was unsatisfactory and a fresh arrangement needed to secure the due performance of the religious services. It was ordained that henceforth three regular canons should celebrate in Elsingspital for the souls of the founders, and two at Thele.

MASTERS OR WARDENS OF THELE COLLEGE

- Richard, occurs Michaelmas 1326 and Easter 1327¹³
- Hugh, occurs 1349¹⁴
- Ralph at Hall, resigned 1384¹⁵
- John Buk, appointed 6 August 1384,¹⁶ resigned in 1385¹⁷
- John Brunne, appointed 5 May 1385,¹⁸ resigned 1386¹⁹
- John Aston, appointed 4 November 1386, resigned in 1395²⁰

⁷ *Cal. Pat.* 1348-50, p. 100.

⁸ The will was proved Nov. 1349 (Sharpe, *Cal. of Wills proved in Ct. of Husting, London*, i, 618).

⁹ *Cal. Pat.* 1350-4, p. 433.

¹⁰ *Ibid.* 1345-8, p. 87.

¹¹ *Ibid.* 1429-36, p. 146.

¹² It is interesting to see that in one case recorded, a claim by Ralph son of Arnald in the Hale in 1326 and 1327 to land, wood and pasture in Amwell, the master of St. Margaret's did not appear (De Banco R. 269, m. 48).

¹³ De Banco R. 269, m. 48. ¹⁴ Sharpe, loc. cit.

¹⁵ Lond. Epis. Reg. Braybrook, fol. 28 d.

¹⁶ *Ibid.* ¹⁷ *Ibid.* fol. 36. ¹⁸ *Ibid.* ¹⁹ *Ibid.* fol. 49.

²⁰ *Ibid.* On 9 Nov. a man of the same name is mentioned by the Bishop of London as preaching without licence and spreading erroneous doctrines (*ibid.* fol. 330 d.), but he can hardly be the warden.

¹ Cott. Chart. xxix, 44.

² To pray for himself and Margaret his wife, Robert Earl of Oxford and Thomas his son (Lond. Epis. Reg. Braybrook, fol. 199 d.). Earl Robert confirmed Goldington's grant to the chantry (*ibid.*).

³ *Ibid.* The royal licence for the alienation in mortmain was given in February (*ibid.* fol. 199; *Cal. Pat.* 1313-17, p. 434).

^{3a} Morant, *Hist. of Essex*, ii, 201.

⁴ Cott. Chart. xxix, 44.

⁵ Lond. Epis. Reg. Braybrook, fol. 200. Goldington's ratification of the appropriation made at his instance is dated 12 Mar. 1317-18 (Cott. Chart. v, 46).

⁶ 'Superpelliciis et capis ac amiciis nigris superius induantur.'

RELIGIOUS HOUSES

Richard Shellee, appointed 21 October
1395²¹

John Howeden, occurs at the dissolution of
the college, March 1431²²

ALIEN HOUSE

20. WARE PRIORY

The foundation of the Benedictine priory at Ware was due to Hugh de Grentemaisnil's gift of the church, tithe and 2 carucates of land here¹ to the abbey of St. Evroul in Normandy.² There is no evidence when the house was built, but the large amount of property in England granted by the Conqueror's Norman followers to St. Evroul's must soon have made the establishment of a cell expedient, if not necessary.³

Apparently the earliest reference to the house occurs in a charter of William Bishop of Lincoln c. 1203-6,⁴ ratifying as a grant of Earl Robert of Leicester to Hubert Prior of Ware a gift that had been made by the earl's mother, Parnel, to St. Evroul's.⁵ But it seems likely that the Prior of Ware had long transacted the abbot's business in England, for from this time onward he is spoken of as the owner of the English possessions of the Norman monastery.⁶

Of the priory there is never much information. Something, however, is heard of its relations with its patrons, the manorial lords, in the 13th century. Through the marriage of Parnel, Hugh de Grentemaisnil's great-granddaughter, Ware Manor had passed to the Beaumonts.⁷ Robert Earl of Leicester⁸ dying without issue in 1204, it fell to his sister and co-heir Margaret wife of Saher de Quency Earl of Winchester. The Countess Margaret built in the priory a great hall, a large chamber, and a chapel for her greater convenience when she chose to stay there, and in this hall she held her manorial courts.⁹ Her son Roger,¹⁰ who succeeded her in 1235,¹¹ made the same use of the priory, as did also his brother Robert, to whom he trans-

ferred the manor.¹² In 1271 Robert's daughter Joan, wife of Humphrey de Bohun, became lady of the manor of Ware.¹³ The inconvenience to the monks of a semi-public hall must by this time have become apparent, for the prior built a small one for their own use during Humphrey's frequent visits.¹⁴ After her husband's death Joan added another chamber to ensure herself better accommodation during residence at Ware. She died in November 1283,¹⁵ and when the escheator arrived at the priory to take possession of her property in the king's name he found the windows and doors of these houses in the close barred against him by the prior. Afterwards with the help of the Earl of Gloucester's men a forcible entrance was effected, but meanwhile the prior had had Joan's new chamber pulled down, and a suit was brought against him in consequence by Joan's heir, her sister Hawise Wake.¹⁶ The prior's action seems unjustifiable, but it may have been a protest against the patron's real or supposed encroachment.

The head of an alien priory was not in an easy position. The fulfilment of his duty to his superior sometimes meant unfairness to the people among whom he was living; on the other hand, if he did not uphold his rights firmly he might certainly have lost them all. The pension of 10 marks demanded by the prior from the vicar of Ware made it almost impossible to get a priest to serve the church. The parishioners therefore appealed to Pope Gregory IX, and the Bishop of London and Dean of St. Paul's, appointed by him to settle the matter, decided in 1231 that the prior was not to require the pension in future, and if he did the vicar should have certain tithes.¹⁷

In the dispute between Fulk Prior of Ware and the Abbot of Cumbermere in 1281-2 over the church of Drayton, in Hales, co. Stafford,¹⁸ the abbot was undoubtedly in the wrong. After judgement had been given by the Archbishop of Canterbury for the prior, he was dispossessed of the church by the secular authority through the abbot's misrepresentations. However, he won in

²¹ Lond. Epis. Reg. Braybrook, fol. 49.

¹ Charter of William I from Ordericus Vitalis (Dugdale, *Mon.* [ed. 1682], ii, 966).

² Hugh and his relatives refounded the abbey (*ibid.*).

³ For a list of the possessions of the monastery in England see Round, *Cal. Doc. France*, 229 et seq.

⁴ Round, *op. cit.* 227.

⁵ A house at Charley (co. Leics.) and a carucate of land in the essarts of Anstey (co. Herts.) (Round, *op. cit.* 228).

⁶ *R. of Hugh de Welles* (Cant. and York. Soc.), ii, 274, 319; see also *Pope Nich. Tax.* (Rec. Com.), *passim*.

⁷ Round, *op. cit.* 229.

⁸ Parnel's son.

⁹ Assize R. 1256, m. 39 (12 Edw. I).

¹⁰ Called William in the Assize R.

¹¹ *Excerpta e Rot. Fin.* (Rec. Com.), i, 274.

²² *Cal. Pat.* loc. cit.

¹² Assize R. 1256, m. 39.

¹³ *V.C.H. Herts.* iii, 386.

¹⁴ Assize R. 1256, m. 39.

¹⁵ Chan. Inq. p.m. 12 Edw. I, no. 27.

¹⁶ Assize R. 1256, m. 39.

¹⁷ Lond. Epis. Reg. Gilbert, fol. 169-70.

¹⁸ *Reg. Epist. John Peckham* (Rolls Ser.), i, 209-10 .
ii, 432.

A HISTORY OF HERTFORDSHIRE

the end,¹⁹ for the church figures in the list of the Prior of Ware's property in 1297.²⁰

Fulk's predecessor, William, had been excommunicated by Archbishop Kilwardby, but the reason is not disclosed.²¹ Archbishop Peckham absolved him in August 1279, the penance enjoined being that every sixth day to the number of forty he should fast on bread, fish and ale, feed ten poor, and on that day and the following say fifty psalms.

During the war with France, 1295-8, the priory was taken into the king's hands.²² In these circumstances a warden was put into the house to see that the monks had no communication with France, to answer at the Exchequer for the issues of the property and receive from the Exchequer what was necessary to maintain the convent.²³ Ill-feeling with France in 1324 caused Edward II to seize the priory's possessions. Two men were appointed to account to the Crown from 8 October to 10 December for the monastic manor and the church at Ware, but these, it was found, had been previously let on lease.²⁴ The prior at this time was probably in difficulties,²⁵ because in July 1319 the king had borrowed of him 100 marks which he did not repay.²⁶

Under Edward III the war with France stopped for a long while the usual relations between the priory and the abbey. The transmission of money to St. Evroul's was forbidden in January 1337,²⁷ and the property of the house, then in the king's hands, was farmed, with the exception of the advowsons, to the prior for £230 a year.²⁸ In April 1348 the king at Queen Isabella's request and on payment of 100 marks granted the prior the advowsons,²⁹ but from September 1349 Edward again presented to the convent's livings,³⁰ a fairly sure proof that the prior had fallen a victim to the Black Death.³¹

The farm due to the king seems to have been sometimes in arrears³² because the prior's tenants did not pay, and between 1342 and 1356 payment of rents to the priory had more than once to be enforced by collectors appointed by the Crown.³³ On the Peace of Brétigny in 1360 royal control over Ware ceased,³⁴ but when the war was resumed in 1369 the priory was taken into the king's hands and again committed to the prior at a rent.³⁵

Richard II in November 1377 made William Herbert, the prior, custodian of the house for £245 a year,³⁶ and on 20 May 1381, at the request of the Princess of Wales,³⁷ confirmed the grant to him for life or as long as the war continued. But when the princess, his patron, died in 1385 Herbert's rights were disregarded, and the custody was given at the same rent to John Golofre, one of the gentlemen of the king's chamber.³⁸

In March 1398 the king assigned the house during the war to his nephew, Thomas Holland Duke of Surrey, without rent,³⁹ and it was probably the duke⁴⁰ who made it over to Mount Grace Priory, co. York.⁴¹

Henry IV in February 1400 gave the Abbot of St. Evroul leave to grant in mortmain the priory of Ware with all its property to the abbey of St. Mary, Leicester,⁴² but this cannot have been done, for in December the king gave Philip Repyndon, Abbot of Leicester, for life the rent paid by the Prior of Ware as farmer of his house.⁴³

In August 1405 Queen Joan received the custody of the priory, valued at £240 a year.⁴⁴

The prior, Nicholas Champene, in February 1410 had licence to bring a monk from St. Evroul's with a servant to live in the priory for life for the maintenance of divine service.⁴⁵ Ware was leased on 24 November 1413 to Champene, a fellow-monk of his called Richard

¹⁹ After an appeal to Rome.

²⁰ *Pope Nich. Tax.* (Rec. Com.), 243b.

²¹ *Reg. of John Peckham* (Cant. and York Soc.), 140.

²² *Pope Nich. Tax.* (Rec. Com.), 249b. Protection was granted to the prior from 1294 to 1298 (*Cal. Pat.* 1292-1307, pp. 91, 97, 176, 270).

²³ Ordinances for the alien religious in 1295 (*Cal. Fine R.* 1272-1307, pp. 362-4). Though principally concerned with the houses near the coast, certain provisions must have been intended for all.

²⁴ Mins. Accts. bdl. 1125, no. 11.

²⁵ In 1327 he was sued for a rent of 4 marks, which had been unpaid for years (*De Banco R.* 269, m. 48).

²⁶ *Anct. Pet.* (P.R.O.), no. 7868. The debt was paid by Edward III (*Cal. Close*, 1327-30, p. 6).

²⁷ *Cal. Close*, 1333-7, p. 643.

²⁸ *Cal. Pat.* 1334-8, pp. 466, 519.

²⁹ *Ibid.* 1334-50, p. 51.

³⁰ *Ibid.* 394.

³¹ H. P. Pollard, 'The Alien Benedictine Priory at Ware,' *East Herts. Arch. Soc. Trans.* iii (2), 126.

³² On 25 June 1343 he was threatened with the loss of the custody if he did not pay £160 immediately to one of the king's creditors (*Cal. Close*, 1343-6, p. 69).

³³ *Cal. Pat.* 1343-5, pp. 226, 385; 1345-8, p. 303; 1348-50, p. 525; 1354-8, p. 340.

³⁴ *Cal. Close*, 1360-4, p. 318.

³⁵ *Close*, 44 Edw. III, m. 3.

³⁶ *Cal. Pat.* 1381-5, p. 13.

³⁷ She became lady of the manor and patron of the priory in 1381 on the death of Blanche Lady Wake (*V.C.H. Herts.* iii, 386).

³⁸ *Anct. Pet.* (P.R.O.), no. 7262.

³⁹ *Cal. Pat.* 1396-9, p. 332. The duke was then patron of the priory.

⁴⁰ Mount Grace was of his foundation.

⁴¹ *Cal. Pat.* 1399-1401, p. 532.

⁴² *Ibid.* 221.

⁴³ *Ibid.* 206. The prior was farming the property of Ware in May (*ibid.* 276).

⁴⁴ *Cal. Pat.* 1405-8, p. 48.

⁴⁵ *Ibid.* 1408-13, p. 157.

RELIGIOUS HOUSES

Baussain, the Earl of Arundel and others for 400 marks a year,⁴⁶ but in 1414 it was suppressed with other alien priories, and finally passed to the king, who granted it and all its possessions on 1 April 1415 to his new foundation at Sheen.⁴⁷

The establishment at Ware appears at one time to have been fairly large, for the prior was accompanied on a journey to France in 1343 by ten of his household.⁴⁸ Of the convent nothing is known, but it is probable that it dwindled considerably during the 14th century.⁴⁹

The property of the priory was valued in 1297 at about £200 per annum,⁵⁰ but as this amount at least was paid for its custody in the 14th century it must then have been worth more.

PRIORS OF WARE

- Richard (?), occurs 1174⁵¹
Hubert, occurs c. 1203-6⁵²
A., occurs 1219⁵³
William, occurs 1231⁵⁴ and 1234⁵⁵
Nicholas, occurs c. 1235-9⁵⁶

- John, occurs January 1259-60⁵⁷
William, occurs 1278-9⁵⁸
Fulk, occurs 1281-2⁵⁹
Ralph, occurs June 1297⁶⁰
Hugh, occurs 1327-8⁶¹
William Herbert, occurs November 1377-
May 1381⁶² and 1385⁶³
Nicholas Champene, occurs February 1410,⁶⁴
24 November 1413,⁶⁵ and at the dissolution
of the priory⁶⁶

A seal, a pointed oval in shape, attached to an agreement of 1260,⁶⁷ shows the prior vested for mass and standing on a carved corbel with a book in his hands. Legend: s' IOHANNIS : PRIORIS : DE : WARE.

On the seal of Ralph, prior of this house,⁶⁸ two figures are represented standing in a double niche under a canopy, the one a king, the other a bishop or abbot; in the field on each side are three roses. In the base, under a pointed arch the prior kneels in prayer. Legend: . . . M : RADVLPH . . . ORIS : DE . . .

HOSPITALS

21. HOSPITAL OF ST. MARY BIGGING, ANSTEY

It is not known when or by whom¹ the hospital of St. Mary Bigging or of the Bigging in the

parish of Anstey was founded, but it existed and had land in Buckland in 1287² and paid subsidy in 1291.³

An exchange of lands was effected between Dionisia de Monchesney, lady of Anstey Manor at this time,⁴ and John the warden of Bigging,⁵ possibly John de Boclone, master in 1308.⁶

⁴⁶ *Parl. R.* iv, 313*b*. The farm was paid until March 1415.

⁴⁷ *Parl. R.* v, 365.

⁴⁸ *Cal. Pat.* 1343-5, p. 35.

⁴⁹ If the monks were French the number of the convent must have decreased through the restriction on the admission of aliens during the French wars. But in any case the higher rent paid by the prior for the custody as time went on indicates less expense in the house itself or in other words a smaller convent, since it is not likely that the property of the priory increased much in amount or value.

⁵⁰ *Pope Nich. Tax.* (Rec. Com.), 31*b*, 38, 38*b*, 45*b*, 49*b*, 56, 57, 59*b*, 63, 63*b*, 64, 64*b*, 65, 65*b*, 67, 69*b*, 100*b*, 114, 162, 165*b*, 196*b*, 219, 223, 227, 228, 237*b*, 243*b*, 249*b*, 251, 251*b*, 270; Harl. MS. 60, fol. 12*b*, 29*b*.

⁵¹ He was then proctor of St. Evroul in England (Round, op. cit. 226), and therefore probably Prior of Ware.

⁵² *Ibid.* 227.

⁵³ *R. of Hugh de Welles* (Cant. and York Soc.), i, 49.

⁵⁴ Lond. Epis. Reg. Gilbert, fol. 169-70.

⁵⁵ *R. of Hugh de Welles* (Cant. and York Soc.), ii, 323.

⁵⁶ Anct. D. (P.R.O.), A 2447.

¹ Possibly the owner of Anstey was the founder or principal benefactor, for in 1435 the hospital was said to be of the foundation of the Duke of York (Early Chan. Proc. bdl. 39, no. 24), then lord of Anstey (see above, p. 13).

⁵⁷ Harl. Chart. 84 D 56.

⁵⁸ *Reg. of Archbp. Peckham* (Cant. and York Soc.), 140.

⁵⁹ *Reg. Epist. John Peckham* (Rolls Ser.), i, 209-10; ii, 432.

⁶⁰ *Cal. Pat.* 1292-1301, p. 270.

⁶¹ De Banco R. 1 Edw. III, m. 42; 2 Edw. III, m. 237.

⁶² *Cal. Pat.* 1381-5, p. 13.

⁶³ A petition from the prior, who must have been Herbert (Anct. Pet. [P.R.O.], no. 7262), speaks of the Princess of Wales as dead, and is therefore later than Aug. 1385.

⁶⁴ *Cal. Pat.* 1408-13, p. 157.

⁶⁵ *Parl. R.* iv, 313*b*.

⁶⁶ 20 July 1414 he is called Prior of Noion of Newmarket, *alias* Prior of Ware (*Cal. Pat.* 1413-16, p. 89).

⁶⁷ Harl. Chart. 84 D 56.

⁶⁸ B.M. Seals, lxiv, 72.

² Assize R. 325, m. 2.

³ Lay Subs. R. bdl. 120, no. 2. The master paid 31*s.* 3½*d.* for property in Anstey, 21*s.* 3½*d.* for that in Little Hormead.

⁴ *Ibid.*; Cussans, *Hist. of Herts. Edwinstree Hund.*

56. She died in 1313.

⁵ Anct. D. (P.R.O.), A 1040.

⁶ Sharpe, *Cal. of Letter-Bk. B.* 95.

A HISTORY OF HERTFORDSHIRE

Protection was given by the king in May 1316⁷ and December 1325⁸ to the keeper or warden of this house.

In 1343, at the request of John Darcy le fitz, Edward III gave the chaplains of the hospital licence to acquire in mortmain land and rent to the yearly value of £10⁹; and in part satisfaction of this amount they received in 1350 100s. rent from land in Great and Little Chishall (co. Camb.),¹⁰ in 1353 messuages and land in Buntingford, Barkway, Hormead, Braughing, Buckland, Wyddial and Alswick in Layston worth 16s. a year,¹¹ and in 1366 75 acres and 10s. rent in Great and Little Hormead, Braughing and Buntingford.¹²

This house is sometimes called the 'poor' hospital of St. Mary,¹³ no doubt with truth, since only the brothers' pressing need could have caused their arrangement in 1405 with a certain Ralph Cokkyng.¹⁴ For 50 marks they made over to Ralph for sixty years land in Little Hormead and elsewhere valued at 5 marks a year. It was understood that Ralph was to settle land in Royston worth 40s. a year on the hospital, but he never did so. Thirty years later it was alleged that damage to the extent of more than 50 marks had been done to the hospital's property by Ralph's son and successor. The hospital or free chapel,¹⁵ as it had now become, is not mentioned again until August 1589, when it was granted by the Crown to William Tipper and Robert Dawe.¹⁶

MASTERS OR WARDENS¹⁷ OF ST. MARY BIGGING, ANSTEY

- John, occurs 1287¹⁸
 John de Boclonde, occurs August 1308¹⁹
 Richard, occurs 1368²⁰
 Nicholas Mokkyng, occurs January 1401²¹
 and c. 1405²²
 Thomas Whightfeld, occurs c. 1435²³

⁷ *Cal. Pat.* 1313-17, p. 462.

⁸ *Ibid.* 1324-7, p. 202.

⁹ *Ibid.* 1343-5, p. 155.

¹⁰ *Ibid.* 1348-50, p. 569.

¹¹ *Ibid.* 1350-4, p. 423.

¹² *Pat.* 40 Edw. III, pt. ii, m. 9.

¹³ *Cal. Pat.* 1343-5, p. 155; 1348-50, p. 569.

¹⁴ *Early Chan. Proc.* bdle. 39, no. 24.

¹⁵ In 1401 it is called a chapel or college.

¹⁶ *Pat.* 31 Eliz. pt. v, m. 37.

¹⁷ The master in the Lay Subs. R. of 1291 (bdle. 120, no. 2) is called 'prior.'

¹⁸ *Assize R.* 325, m. 2.

¹⁹ Sharpe, *op. cit.* 95.

²⁰ Dugdale, *Mon.* vi, 762.

²¹ *Cal. Pat.* 1399-1401, p. 363. He was also a prebendary of the collegiate church of Llandewybreny in the diocese of St. Davids.

²² *Early Chan. Proc.* bdle. 39, no. 24.

²³ *Ibid.*

22. HOSPITAL OF ST. JOHN BAPTIST, BERKHAMPSTEAD

The earliest mention of this hospital occurs in a charter of Geoffrey Fitz Piers Earl of Essex,²⁴ which shows that the custody of the house had already been committed by him to the brothers of St. Thomas the Martyr of Acon.

On 1 March 1216-17 Queen Isabel for the soul of King John gave the hospital to the canons of Acon,²⁵ but whether this was a confirmation of Fitz Piers's deed or an amplification is not clear. The queen added that the hospital had of her gift tithes of all her mills in the sokes of Berkhamstead and Hemel Hempstead, 15 acres of land in 'Selidone' and all the dike work with herbage between the fish-pond and the hospital, the whole length of the fish-pond, viz., from the road called Water Lane to the church of St. James, the land late of Roger the Cordwainer, and another piece next the hospital, 15 cartloads of fuel in the 'hay' of Berkhamstead and 25 loads in the wood of 'Brennendon,' perhaps Bovingdon in Hemel Hempstead, leave to feed 20 pigs in the said 'hay' and wood, and pannage and pasture for the hospital's cattle in the common pastures of Berkhamstead. As Isabel confirmed to the hospital whatever it had already acquired in her fee of Berkhamstead and in Hemel Hempstead, these gifts were possibly fresh endowment. It will be noticed that the hospital had, or by this charter acquired, rights in the property lying between its site and the chapel of St. James, the proximity of which appears to have led to an interchange of the names of the two foundations. Thus Chauncy²⁶ speaks of the hospital of St. James so called from St. James's Well,²⁷ while the spring itself has for some time now been known as St. John's Well. The hospital chapel was rebuilt in 1331 and was consecrated at the end of that year or the beginning of the next.²⁸

²⁴ *Inspeximus* and confirmation July 1325 (*Cal. Pat.* 1324-7, p. 128).

²⁵ *Inspeximus* and confirmation 10 Dec. 1318 (*Cal. Chart. R.* 1300-26, p. 399). A hospital of Berkhamstead was confirmed to the canons of Acon by Pope Honorius 7 July in the fourth year of his rule, probably Honorius III in 1220 (*Cott. MS.* Tib. C v, fol. 271).

²⁶ *Hist. Antiq. of Herts.* 587.

²⁷ Cobb (*Hist. and Antiq. of Berkhamstead*, 72) marked this spot as the site of one of the hospitals, pointing to the names 'Spital Mead' and 'the Spital trees' in proof, but he thought the hospital that of St. John the Evangelist. The nearness of the hospital of St. John Baptist to the old parochial chapel makes the connexion of both with the brotherhood of St. John Baptist seem more probable. See *V.C.H. Herts.* ii, 163, 172.

²⁸ The Bishop of Lincoln's commission to Peter Bishop of 'Corbavia' to consecrate is dated 8 kal. Jan. 1331 (*Linc. Epis. Reg. Memo.* Burghersh, fol. 239).

RELIGIOUS HOUSES

From that time there is no mention of the house of St. John Baptist. A report, however, made in 1540 on the leper hospitals of Berkhamstead³⁹ says that a warden, brothers and sisters had been possessed of two, one called the Overspithouse or St. John the Evangelist, the other the Netherspithouse or St. Leonard, and as the property in Berkhamstead, Northchurch and Hemel Hempstead included the tithes of six water-mills and a fulling-mill, it seems likely that the hospital of St. Leonard³⁰ was identical with that of St. John Baptist.³¹ Apparently the two houses had been united before 1515-16, since there was then only one warden, and at that time the departure of the inmates brought the existence of the remaining hospital to a close.³²

There are several references to the hospital of St. Thomas the Martyr of Berkhamstead, but it is clear that they refer to either the hospital of St. John Baptist or that of St. John the Evangelist, which both belonged to the monastery of St. Thomas the Martyr of Acon, and were therefore probably known by the name of the superior house.³³

23. HOSPITAL OF ST. JOHN THE EVANGELIST, BERKHAMPSTEAD

The hospital of St. John the Evangelist for lepers was founded at Berkhamstead certainly before 1213, for it is the subject of a charter of Geoffrey Fitz Piers Earl of Essex, who died in that year. The earl, who was evidently patron of the hospital,³⁴ committed it to the custody of the brothers of St. Thomas of Acon, so that under their supervision its goods and alms might be expended on the poor and sick of the hospital, and not be removed elsewhere.³⁵

The master, brothers and sisters of the house received letters of protection in February 1222 until the king's coming of age,³⁶ and in May 1227, when the king had attained his majority,

³⁹ Rentals and Surv. (Gen. Ser.), portf. 25, no. 37.

³⁰ St. Leonard was a favourite saint with commercial communities, and this would therefore be a probable invocation, supposing the connexion between the gild and the hospital.

³¹ Especially as the foundation of both hospitals, St. Leonard's as well as St. John the Evangelist's, is attributed to King John.

³² As to the connexion of this hospital with Berkhamstead Grammar School see *V.C.H. Herts.* ii, 72, 172.

³³ See *Rot. Lit. Claus.* (Rec. Com.), ii, 19, 21; *Cal. Pat.* 1317-21, p. 68; *Lay Subs. R. bdle.* 120, no. 2; *Cant. Archiepis. Reg. Courtenay*, fol. 280b; *Ct. R.* (Gen. Ser.), portf. 177, no. 15.

³⁴ No doubt in virtue of the king's grant of Berkhamstead Manor to him.

³⁵ *Inspeximus and confirmation* 3 July 1325 (*Cal. Pat.* 1324-7, p. 128).

³⁶ *Cal. Pat.* 1216-25, p. 325.

the protection was renewed.³⁷ A few weeks before Henry had ordered the constable of Berkhamstead to supply the lepers of St. John's for their maintenance with 4 qrs. of corn from his grange and two 'bacones.'³⁸

Whatever Fitz Piers's charter may have given the canons of Acon,³⁹ the right of appointing the master of St. John's was not included. This apparently belonged to the owner of Berkhamstead⁴⁰: in November 1336, when the honour was in the king's hand, he gave the custody of the hospital to one of his clerks⁴¹; and Henry VI, while he held the manor, presented the warden.⁴²

In 1391 the house is mentioned as the hospital of brothers and sisters of St. Thomas the Martyr and St. John the Evangelist.⁴³

Edward IV in November 1461 inspected and confirmed Fitz Piers's deed in favour of the brothers of Acon,⁴⁴ and when the hospital, with that of St. Leonard, came to an end in 1515-16⁴⁵ the master of St. Thomas of Acon entered into possession of the house and its property.⁴⁶ Probably the chapel was served for some years longer.⁴⁷ In September 1533, however, the

³⁷ *Cal. Chart. R.* 1226-57, p. 35.

³⁸ *Rot. Lit. Claus.* (Rec. Com.), ii, 173.

³⁹ As far as is known the house of Acon had no land at Berkhamstead, and in that case the suit of court there owed by the master in 1498 and 1507 (*Ct. R.* [Gen. Ser.], portf. 177, no. 15) can only have been due from him as representative of the Berkhamstead hospitals.

⁴⁰ The honour, which reverted to the Crown soon after Geoffrey Fitz Piers's death, seems after the gift of it with the earldom of Cornwall by Henry III in 1227, to have been held by the Earls of Cornwall. It was thus held by John de Eltham, who was created Earl of Cornwall in 1328 by his brother Edward III; and it was in the interval between John's death in Oct. 1336 and the bestowal of the duchy of Cornwall upon Prince Edward in Feb. 1337 that the king presented to the hospital. From this date for a long period the manor belonged to the Duke of Cornwall or Prince of Wales, and in 1423 the hospital was said to be in the gift of the king as Prince of Wales (*Cal. Pat.* 1422-9, p. 163). For the descent of the manor of Berkhamstead see *V.C.H. Herts.* ii, 165-8.

⁴¹ *Cal. Pat.* 1334-8, p. 336.

⁴² *Ibid.* 1422-9, p. 163; 1446-52, p. 42.

⁴³ *Lambeth, Cant. Archiepis. Reg. Courtenay*, fol. 280 d.

⁴⁴ *Cal. Pat.* 1461-7, p. 60.

⁴⁵ By the voluntary departure of the inmates (*Rentals and Surv.* [Gen. Ser.], portf. 25, no. 37).

⁴⁶ *Ibid.*

⁴⁷ At the inquiry of Mar. 1540 it was stated that Laurence Coperler, late master of St. Thomas of Acon, and John St. John, chaplain, held the hospitals and the issues of their property from Apr. 1525 to Sept. 1533 (*ibid.*). There seems to be a mistake as regards the first date, for Coperler did not become master of St. Thomas of Acon until 1527 (*V.C.H. Lond.* i, 495).

A HISTORY OF HERTFORDSHIRE

place was made over to Thomas Jakes of Berkhamstead, gentleman, who in January 1536 disposed of a gilt chalice, a mass-book, three vestments and other ornaments, and in September 1539 sold the lead roof of the chapel and its bells.⁴⁸ The existence of the house was over long before the king granted it and its lands in June 1540 to Robert Horderne.⁴⁹

WARDENS OF THE HOSPITAL OF ST. JOHN THE EVANGELIST, BERKHAMPSTEAD

John de Rasen, appointed 15 November 1336⁵⁰

Henry Cows, chaplain, appointed March 1390-1⁵¹

John Mildenale, resigned 1423⁵²

William Seyntpoul, appointed 11 December 1423,⁵³ died February 1447⁵⁴

Walter Osborn, appointed 24 February 1447⁵⁵

24. HOSPITAL OF ST. ERASMUS AND ST. MARY MAGDALENE, CHESHUNT

There was at one time in Cheshunt a hospital of St. Erasmus and St. Mary Magdalene, apparently very small and insignificant.⁵⁶⁻⁷ The proctor, Thomas Glasedale, when asked by the vicar-general of the Bishop of London in October 1527⁵⁸ whether the king was their founder, answered that they had neither foundation, incorporation nor bills of privileges. The hospital of St. Mary Magdalene mentioned in connexion with Cheshunt in the Prior of Hertford's accounts of 1497-8⁵⁹ was no doubt this house.

25. HOSPITAL OF ST. MARY MAGDALENE, CLOTHALL

The leper hospital of St. Mary Magdalene, Baldock, was founded within the boundary of Clothall parish, apparently at the beginning of the 13th century, by Sir Hugh de Clothall, kt.,⁶⁰

⁴⁸ Rentals and Surv. (Gen. Ser.), portf. 25, no. 37.

⁴⁹ Pat. 36 Hen. VIII, pt. ix, m. 26.

⁵⁰ Cal. Pat. 1334-8, p. 336.

⁵¹ Through delay in appointing the master, the nomination had fallen to the Archbishop of Canterbury, the see of Lincoln being then vacant (Lambeth Cant. Archiepis. Reg. Courtenay, fol. 280 d.).

⁵² Cal. Pat. 1422-9, p. 163.

⁵³ Ibid.

⁵⁴ Ibid. 1446-52, p. 42.

⁵⁵ Ibid.

⁵⁶⁻⁷ It does not seem to have been known to Tanner.

⁵⁸ Consistory Ct. of London, Vicar-General's book, Foxford, 106.

⁵⁹ Rentals and Surv. R. 277. The entry is as follows: '18*l.* paid to the hospital of St. Mary Magdalene and 12*l.* to the nuns of Cheshunt for the said hospital by reason of a certain agreement.'

⁶⁰ Harl. Chart. 112 A 3.

lord of the manor, the patronage remaining with the owners of the manor.⁶¹

In April 1226 Henry III gave the brothers leave to have a fair at their hospital outside Baldock on the vigil and feast of St. Bartholomew until his majority, and ordered the Sheriff of Hertfordshire to have the fair proclaimed throughout his bailiwick,⁶² but as he came of age in January 1227 and the grant was not renewed, they can only have held the fair once. The brothers and those sent by them to preach for the lepers' maintenance were also given royal letters of protection to last for a year from Christmas 1226.⁶³ Pope Innocent IV in 1244 took under the protection of St. Peter the master and brothers, their house and present and future possessions.⁶⁴

A charter of the 13th century concerning a small grant to the lamp of St. Nicholas⁶⁵ mentions that the chapel was served by two priests. This church was inconveniently situated outside the close at some distance from the hospital, and the master and brothers on 26 April 1275 obtained licence from the king to inclose the intervening high road 588 ft. long and 17 ft. broad on condition that they made another on their own ground.⁶⁶ A few years later the house itself became untenable owing to its solitary position.⁶⁷ The brothers suffered such damage from robbers, who attacked and set fire to the place, that the patrons, John de Hauvill and John de Poley and his wife Muriel,⁶⁸ allowed them to remove to another spot in the parish, providing, however, that the chapel should be built on their fee in 'le Brada' and that a mass should be celebrated every day at the old foundation for the souls of Sir Hugh de Clothall, his wife and parents.⁶⁹ The new hospital was finished in 1308, since leave was then given by the Bishop of Lincoln for the brethren to dwell there and have services in the chapel on obtaining the rector's consent.⁷⁰

Royal protection for a year was granted in December 1325 to the master, John de Wotton.⁷¹

⁶¹ The descendants of Simon, Hugh's brother and successor (*V.C.H. Herts.* iii, 222).

⁶² *Rot. Lit. Claus.* (Rec. Com.), ii, 107.

⁶³ Cal. Pat. 1225-32, p. 95.

⁶⁴ Harl. Chart. 111 A 16.

⁶⁵ Ibid. 112 C 14.

⁶⁶ Inq. a.q.d. file 4, no. 7; Cal. Pat. 1272-81, p. 85.

⁶⁷ It was evidently in a lonely spot, for a premeditated murder was committed in the road by the hospital in 1284-5 (Assize R. 325, m. 31 d.).

⁶⁸ Daughter of Simon de Clothall (*V.C.H. Herts.* iii, 222).

⁶⁹ Harl. Chart. 112 A 3. Perhaps this meant that these services were not to be discontinued at the old chapel until they could be performed in the new.

⁷⁰ Linc. Epis. Reg. Inst. Dalderby, fol. 239.

⁷¹ Cal. Pat. 1324-7, p. 192.

RELIGIOUS HOUSES

The office of warden or master was held more than once with other livings. In 1384 Richard II presented the warden, John atte Lee, to a church in South Wales⁷²; in 1446 the pope provided John Bagot, the then master, to a canonry in the college of South Malling,⁷³ and in 1526 the master, Thomas Dalison, was rector of Clothall.⁷⁴

As usual it is difficult to discover how long the place was really a hospital. There is no actual reference to the brothers after 1308, though no doubt a community existed there until much later⁷⁵; but as in 1446 it is styled the hospital or free chapel of Clothall⁷⁶ it had evidently already become a mere chantry, which under the name of hospital⁷⁷ survived until the reign of Edward VI. Its net value was returned in 1535 as £3 2s. 8d.,⁷⁸ in 1547-8 as £3 11s. 11½d.⁷⁹

MASTERS OR WARDENS OF CLOTHALL HOSPITAL

- J., chaplain, instituted 1242-3⁸⁰
- John, died 1265⁸¹
- Reynold de Little Stokton, instituted 1265,⁸² resigned 1301⁸³
- Walter de Little Stokton, instituted 1301,⁸⁴ resigned 1314⁸⁵
- John de Wotton, instituted 1314,⁸⁶ occurs 3 December 1325,⁸⁷ died 1349⁸⁸
- John de Leecheworth, instituted 1349⁸⁹
- John atte Lee, occurs 16 July 1384⁹⁰

⁷² *Cal. Pat.* 1381-5, p. 443.

⁷³ *Cal. of Papal Letters*, viii, 310.

⁷⁴ Salter, *A Subsidy Collected in the Dioc. of Linc. in 1526*, p. 179.

⁷⁵ The human remains found near the traditional site of the hospital seem to indicate that the house had a burial-ground (H. C. Andrews, 'The Hospital of St. Mary Magdalene, Baldock and Clothall,' *East Herts. Arch. Soc. Trans.* iv, pt. 1, 90).

⁷⁶ *Cal. of Papal Letters*, viii, 310.

⁷⁷ It is called hospital in Chan. Inq. p.m. 33 Hen. VI, no. 31; 4 Edw. IV, no. 25; (Ser. 2), i, 134; xi, 12; free chapel or hospital in the *Valor Eccl.* (Rec. Com.), iv, 278.

⁷⁸ *Valor Eccl.* loc. cit.

⁷⁹ Chant. Cert. 20, no. 65. It is described here as a free chapel, founded towards finding a priest for ever. The foundation cannot be shown. The chapel was distant from the church a mile or more. It had no plate, jewels, goods or chattels.

⁸⁰ Linc. Epis. Reg. Grosteste R. 8.

⁸¹ Clutterbuck, *Hist. and Antiq. of Herts.* iii, 506. Probably the man instituted by Bishop Grosteste.

⁸² *Ibid.*

⁸³ Linc. Epis. Reg. Inst. Dalderby, fol. 231 d. Reginald occurs 1290-1 (Lay Subs. R. bde. 120, no. 2).

⁸⁴ Linc. Epis. Reg. Inst. Dalderby, fol. 231 d.

⁸⁵ *Ibid.* fol. 248.

⁸⁶ *Ibid.*

⁸⁷ *Cal. Pat.* 1324-7, p. 192.

⁸⁸ Linc. Epis. Reg. Inst. Gynwell, fol. 343.

⁸⁹ *Ibid.*

⁹⁰ *Cal. Pat.* 1381-5, p. 443.

William Tamworth⁹¹

John Bagot, occurs October 1446⁹²

Walter Dyer, instituted 1453,⁹³ resigned 1468⁹⁴

John Edom, instituted 1468,⁹⁵ occurs 20 October 1473,⁹⁶ died 1474⁹⁷

William Hanford, instituted 1474⁹⁸

John Serle, resigned 1486⁹⁹

William Frank, instituted 1486,¹⁰⁰ resigned 1491¹

William Exham, instituted 1491,² died 1493³

William Awnger, instituted 1493,⁴ died 1502⁵

Thomas Dalison, instituted 1502,⁶ occurs 1526,⁷ died 1541⁸

Thomas Boldron, instituted 1541⁹

26. HOSPITAL OF ST. LAUD AND ST. ANTHONY, HODDESDON

The earliest mention of this hospital is in 1390, when the Bishop of Ely granted indulgences for the poor and lepers of that house and of St. Margaret, Thetford.¹⁰ One of the two seals of the Hoddesdon Hospital, both apparently of the 15th century, shows that the house was also called St. Clement,¹¹ so that there was probably at some time a change of dedication.¹² During this period, too, the character of the hospital itself was perhaps altered. It seems to have been originally intended, in part at any rate, for lepers,¹³ but in the 16th century it was

⁹¹ Early Chan. Proc. bde. 3, no. 34. He exchanged with John Bernard, parson of Elstree, who could not obtain the office vacated and petitioned the chancellor on the subject. The case occurred between 1386 and 1413.

⁹² *Cal. of Papal Letters*, viii, 310.

⁹³ Linc. Epis. Reg. Inst. Chedworth, fol. 186.

⁹⁴ *Ibid.* fol. 199 d.

⁹⁵ *Ibid.*

⁹⁶ Add. Chart. 35385.

⁹⁷ Linc. Epis. Reg. Inst. Rotheram, fol. 111 d.

⁹⁸ *Ibid.*

⁹⁹ *Ibid.* Inst. Russell, fol. 138.

¹⁰⁰ *Ibid.*

¹ *Ibid.* fol. 142.

² *Ibid.*

³ *Ibid.* fol. 144.

⁴ *Ibid.*

⁵ *Ibid.* Inst. Smith, fol. 407 d.

⁶ *Ibid.*

⁷ Salter, op. cit. 179.

⁸ Clutterbuck, op. cit. iii, 507.

⁹ Linc. Epis. Reg. Inst. Longland, fol. 233 d.

¹⁰ Gibbons, *Cal. of Ely Epis. Rec.* 397. William of the Hospital, one of the tenants of Hoddesdonbury Manor in 1394 (Tregelles, *Hist. of Hoddesdon*, 229), may have been the master of the house.

¹¹ B.M. Seals, D.C., G 19.

¹² Tregelles, op. cit. 27.

¹³ Mr. Tregelles doubts it (op. cit. 235), but the warden said in 1568 (*ibid.* 231) that the foundation was given for poor lazars, *leprous* and impotent persons then and thereafter to be maintained.

A HISTORY OF HERTFORDSHIRE

a hospital or almshouse for poor men and women. Apparently there was no foundation charter, but the warden or 'guydor' held the house on lease from the lord of the manor.¹⁴ William Thompson, master in 1518, then obtained a fresh lease of the place to himself and his wife at a rent of 2 marks.¹⁵ He was succeeded in 1535 by Gregory Peryes.¹⁶ The house and its property were let in 1561 at 20s. a year for twenty-one years to William Smythe of Newington, who at once sold his interest to Robert Reve, a butcher, and by him the hospital with the government of its inmates was leased for 60s. a year to Thomas Jackson.¹⁷ On 22 April 1568 Jackson complained to Sir William Cecil that Reve did not, as he had promised, repair the hospital, which was in a ruinous state, and that he was making unreasonable waste of the woods belonging to the house.¹⁸ The survey made¹⁹ in consequence a few days later proves the truth of his statements: the two little rooms occupied by the poor people at night let in the rain, and the groves were much damaged by cattle.

As the possessions of the hospital consisted only of a few acres of pasture and wood, the poor there must have maintained themselves by begging; in fact, of the eight inmates²⁰ six were absent at the time of the survey 'gathering the devotion of the people.' The number to be received was left to the warden's decision, and the surveyors drew the natural conclusion that the founders²¹ had lately troubled themselves little about the management of the place. The hospital lasted but a short time longer, the building²² in 1573 being used for a school.²³

WARDENS OR GOVERNORS OF HODDESDON HOSPITAL

John Jenkinson, shortly before 1518²⁴

William Thompson, occurs 1518 to 1535²⁵

Gregory Peryes, became warden in 1535²⁶

¹⁴ Survey of the hospital 29 Apr. 10 Eliz. (Tregelles, *Hist. of Hoddesdon*, 234).

¹⁵ *Ibid.* 235. ¹⁶ *Ibid.*

¹⁷ *Ibid.*

¹⁸ *Ibid.* 231.

¹⁹ The petition and survey which are at Hatfield House are printed in full by Mr. Tregelles (*op. cit.* 231-4).

²⁰ From Jackson's petition it might be inferred that there were twelve brothers and sisters, but perhaps he meant that the hospital was intended for that number.

²¹ To these there is no clue. The one bequest to the house known is Sir William Say's in 1529 (P.C.C. 6 Thower), but a legacy of 6s. 8d. does not argue great interest.

²² It comprised a hall, kitchen, chapel and the two little rooms mentioned above.

²³ Tregelles, *op. cit.* 235.

²⁴ *Ibid.*

²⁵ *Ibid.*

²⁶ *Ibid.*

Thomas Jackson, became warden 5 October 1566,²⁷ occurs April 1568²⁸

Thomas Thurgood, occurs 1569²⁹

John Malden³⁰

A seal of this house,³¹ in the style of the 15th century, is a pointed oval, and represents two saints in a niche with heavy canopies and tabernacle work at the sides. The saint on the left, St. Antony, holds in his right hand a long tau cross, in the other a book, while at his feet is a pig; St. Laud, wearing mitre and vestments, holds blacksmith's pincers in his left hand and a hammer in his right. In the background are sprays of foliage. Legend: SIGILLUM OSPITALIS SANCTI ANTONI LOCI DE HODSTUN. Another³² of the same shape and style also shows two saints under heavily canopied Gothic niches. The saint on the left is again represented with a tau cross in his right hand and a book in his left, but the pig is not shown at his feet.³³ St. Laud,³⁴ as before, holds a hammer, but in his left hand: his right is raised in benediction. In the base are two emblems, the anchor of St. Clement under St. Antony and a horseshoe under St. Laud. Legend: SIGILLUM HOSPITALIS SANCTI CLEMENT' LOCI DE HODDES DON.

27. HOSPITAL OF ST. JOHN AND ST. JAMES, ROYSTON

The founder of the hospital of St. James at Royston³⁵ was probably Richard Argentein, as stated in 1547-8.³⁶ The patronage belonged in 1276 to his son Giles Argentein, and continued to be exercised by his descendants³⁷; while the house was certainly in existence in Richard's time, since in 1227 Walter de Gray, Archbishop of York, granted an indulgence of thirteen days to all who contributed to the support of the sick brothers and sisters coming to the hospital of the Blessed Virgin Mary and St. James of Royston.³⁸

²⁷ Tregelles, *op. cit.* 232.

²⁸ *Ibid.*

²⁹ He rented the land then (*ibid.* 235).

³⁰ He still occupied the land in 1573, when the school took the place of the hospital (*ibid.*).

³¹ B.M. Seals, lxiv, 68.

³² *Ibid.* D.C., G 19.

³³ The catalogue describes the object under the saint on the left as a pig, but there seems no doubt (Tregelles, *op. cit.* 21) that it is an anchor.

³⁴ According to the catalogue description this is St. Clement.

³⁵ From a survey of the parish taken in 1630 the hospital was evidently situated at the corner of Baldock Street and Dead Street in co. Hertford (Add. MS. 5820, fol. 33, 34 d.).

³⁶ Chant. Cert. 20, no. 62.

³⁷ Clutterbuck, *op. cit.* iii, 561.

³⁸ *Archbp. Gray's Reg. (Surt. Soc.)*, 24; Cussans, *Hist. of Herts. Odsey Hund.* 102.

RELIGIOUS HOUSES

Possibly it was a hospital not only for the sick but for poor wayfarers: in 1389 it is mentioned as the house of alms,³⁹ and the Chantry Returns, although confusing the hospital with a chantry there,⁴⁰ report that it was founded for the relief of poor people coming and going through the town of Royston.

Letters of protection were given by Henry III to the master and brothers in 1251,⁴¹ and in 1267, when the hospital is called St. James and St. John.⁴²

In 1302 Bishop Dalderby visited the hospital by deputy, and found its state entirely satisfactory.⁴³

Very little is known about its affairs. The master of St. James was a party to a law-suit about a tenement in 1260-1,⁴⁴ and in 1295 the hospital was taxed at 11s. 2½d. for the eleventh and seventh.⁴⁵ Before the middle of the 14th century the chapel of St. Nicholas was amalgamated with the hospital of St. James,⁴⁶ to the material benefit of the latter, which also in August 1359 received permission from the king to acquire in mortmain land to the annual value of 100s.⁴⁷

In 1389 Thomas Strete bequeathed to the house 20s. to buy beds,⁴⁸ and in 1393 Henry Strete left 6s. 8d. towards the roof of its chapel.

How long the place continued as a hospital is uncertain: in 1486 it was already a free chapel.⁴⁹ It is still called hospital in the Valor,⁵⁰ but the term is evidently a mere sur-

vival, as in the Chantry Returns of 1549-50 where it is applied to what was obviously the chantry of St. Nicholas refounded in the hospital of St. James in the 14th century.⁵¹

Its yearly value in 1535 was £5 6s. 10d. net,⁵² in 1549-50 £7 5s. 5d. gross and £6 8s. 6½d. net,⁵³ its revenues being apparently derived from property in Barley and Therfield (co. Hertford), Kneesworth, Melbourn and Chishall (co. Cambridge).⁵⁴

MASTERS OR WARDENS OF THE HOSPITAL OF ST. JOHN AND ST. JAMES, ROYSTON

William, occurs 1291⁵⁵; William de Melreth, died 1297⁵⁶

John de Litlington, instituted 1297,⁵⁷ died 1335⁵⁸

William de Langrave, instituted 1335,⁵⁹ resigned 1355⁶⁰

John de Norwich, priest, instituted 1355,⁶¹ occurs 1358 and 6 July 1359⁶²

Walter Spersholt, resigned 1363⁶³

John de Eston, instituted July 1363⁶⁴

Philip Walles, resigned 1377⁶⁵

Richard Freman, instituted 1377,⁶⁶ resigned 1389⁶⁷

Thomas Gery, instituted 1389⁶⁸

Thomas Foulmere, resigned 1397⁶⁹

John Wigworth, instituted 1397⁷⁰

Robert Eyr, instituted 1408⁷¹

John Yernyng, instituted 1444⁷²

William Alyngton, died 1452⁷³

⁵¹ Chant. Cert. 20, no. 62.

⁵² *Valor Eccl.* loc. cit.

⁵³ Chant. Cert. 20, no. 62.

⁵⁴ Pat. 5 Jas. I, pt. xvii, m. 16.

⁵⁵ Lay Subs. R. bdle. 120, no. 2.

⁵⁶ Linc. Epis. Reg. Inst. Sutton, fol. 91 d.

⁵⁷ *Ibid.* It is now called the hospital of Saints John and James.

⁵⁸ *Ibid.* Inst. Burghersh, fol. 383.

⁵⁹ *Ibid.*

⁶⁰ *Ibid.* Gynwell, fol. 359.

⁶¹ *Ibid.*

⁶² Chan. Inq. p.m. 33 Edw. III (1st nos.), no. 44; *Cal. Close*, 1354-60, p. 587. He is called warden of the hospital of St. Nicholas, but that had been amalgamated with the house of St. John and St. James.

⁶³ Linc. Epis. Reg. Inst. Buckingham, pt. i, fol. 283 d.

⁶⁴ *Ibid.*

⁶⁵ *Ibid.* fol. 314 d. He then exchanged with Freman, but is still called master of the hospital of Saints John and James, Royston, in 1381 (*Cal. Pat.* 1377-81, p. 555).

⁶⁶ Linc. Epis. Reg. Inst. Buckingham, pt. i, fol. 314 d.

⁶⁷ *Ibid.* pt. ii, fol. 258.

⁶⁸ *Ibid.* He exchanged with Freman.

⁶⁹ *Ibid.* fol. 286.

⁷⁰ *Ibid.* He exchanged with Foulmere.

⁷¹ *Ibid.* Repingdon, fol. 338.

⁷² *Ibid.* Alnwick, fol. 167.

⁷³ Clutterbuck, op. cit. iii, 562.

³⁹ Lond. Epis. Reg. Braybrook, fol. 398 d. No other hospital is known at Royston at this date but that of St. John and St. James.

⁴⁰ It is called the hospital of Richard Argentine founded by licence of Edward III to find a priest for ever for the relief of poor people, &c. Part of this refers to the chantry of St. Nicholas, which was refounded in the reign of Edward III, but part does not. (See Hospital of St. Nicholas, Royston.)

⁴¹ Pat. 35 Hen. III, m. 9.

⁴² *Ibid.* 51 Hen. III, m. 20.

⁴³ Linc. Epis. Reg. Memo. Dalderby, fol. 49 d.

⁴⁴ Kingsbury, *Hist. of Royston*, 48.

⁴⁵ Lay Subs. R. bdle. 120, no. 5.

⁴⁶ See Hospital of St. Nicholas, Royston.

⁴⁷ Pat. 33 Edw. III, pt. ii, m. 12. Licence was given at the request of John of Gaunt, Earl of Richmond, who appears to have been the overlord of the Argenteins (Chan. Inq. p.m. 33 Edw. III [1st nos.], no. 44).

⁴⁸ Lond. Epis. Reg. Braybrook, fol. 398 d., 405 d. The first was rector of Much Hadham, the other, rector of Barley.

⁴⁹ *Cal. Inq. p.m. Hen. VII*, i, 14. William Alington, who died in 1486, held the advowson of a free chapel in Royston. His descendant, Sir Giles Alington, had the advowson of the hospital of St. John and St. James (Feet of F. Div. Co. East. 2 & 3 Philip and Mary), so the free chapel was clearly the same as the hospital. The Alingtons were the heirs of the Argenteins.

⁵⁰ *Valor Eccl.* (Rec. Com.), iv, 278.

A HISTORY OF HERTFORDSHIRE

John Byke, presented 1452,⁷⁴ died 1486⁷⁵
Thomas Payn, presented 1486,⁷⁶ died 1514⁷⁷
John Colyngton, presented 1514,⁷⁸ occurs
1517⁷⁸

28. HOSPITAL OF ST. NICHOLAS, ROYSTON

The hospital of St. Nicholas, Royston, with a chapel in which mass was to be said three times a week for lepers there, was founded, according to the statement of the warden in 1358-9,⁸⁰ by a certain Ralph son of Ralph son of Fulk, who afterwards granted the chapel and advowson of the hospital by charter to Giles de Argentine. As, however, the house was certainly in existence in 1213⁸¹ and Ralph was still living in 1283,⁸² he appears to have been the founder of the chapel rather than of the hospital. Possibly the patronage of the chantry was given to the Argentines because they were already connected with the house: for they seem to have been lords of the site,⁸³ which there is good reason to believe was on the Cambridgeshire side of Royston.⁸⁴

King John received the brothers of the house into his protection in January 1212-13,⁸⁵ and granted them a fair to be held on the vigil and feast of the Translation of St. Nicholas⁸⁶; and Henry III in March 1235-6 confirmed to them the fair, extending its duration to three days.⁸⁷

This fair and 30 acres of land in the neighbourhood given for the maintenance of the chaplain⁸⁸ comprised apparently the whole

endowment of the hospital, which must have depended largely on alms.

Poverty, plague or fear of robbers may have brought it to an end. In July 1359 it was reported as long deserted, 'lepers refusing to come or dwell there,' and the services with the chantry endowment had in consequence been transferred from the chapel of St. Nicholas to that of St. James.⁸⁹ No names of masters survive, for although John de Norwich was called Warden of St. Nicholas in 1359, there was then apparently no hospital of that name in Royston.

29. HOSPITAL OF ST. JULIAN BY ST. ALBANS

Geoffrey Abbot of St. Albans (1119-46), with the consent of the convent, built a hospital for lepers outside St. Albans on a piece of land called Kingesho along Watling Street, and dedicated it to the honour of St. Julian.⁹⁰ For its maintenance he assigned⁹¹ tithe of rent of the vill of St. Albans, viz., 60s.⁹²; rent of 30s. from Sarratt; tithe of corn of the lordships of 'Hamstede'⁹³ and Kingsbury; portions of tithes in the parishes of St. Michael and St. Stephen, Aston, Codicote, and in the lordships of St. Albans and of Roger de Limesy in Bradway in St. Paul's Walden, and certain tithes in Streatley, Henlow, Silsoe, Stanford in Southill (co. Beds.), Ralph Perot's lordships of Lindsell and Hawkswell (co. Essex), and a hide which Robert son of Weneling had in Astwick (co. Beds.). The endowment of Geoffrey and others was confirmed to the hospital by Henry II,⁹⁴ who himself made the lepers a perpetual grant of *1d.* a day,⁹⁵ and the sum of 30s. *5d.* was paid to them annually by the Sheriff of Hertfordshire from 1160 onwards.⁹⁶

⁷⁴ Clutterbuck, op. cit. iii, 562.

⁷⁵ Linc. Epis. Reg. In-t. Russell, fol. 138.

⁷⁶ Ibid.

⁷⁷ Clutterbuck, op. cit. iii, 562.

⁷⁸ Ibid.

⁷⁹ Kingston, op. cit. 207.

⁸⁰ Chan. Inq. p.m. 33 Edw. III (1st nos.), no. 44. He was concerned to prove that the hospital and chantry were not of royal foundation, and that their lands therefore should not have been taken into the king's hands. Apparently he established his case (*Cal. Close*, 1354-60, p. 587).

⁸¹ *Rot. Lit. Pat.* (Rec. Com.), 96.

⁸² See Broadfield, *V.C.H. Herts.* iii, 210.

⁸³ In 1359 the land was held of the Earl of Richmond and John Argentine by the service of finding a lamp in the church of Wendy, co. Camb.

⁸⁴ The old burial ground found at the north end of the town (Kingston, op. cit. 46-7) was probably the cemetery of this hospital, for the advowson of St. Nicholas Chapel, Royston, figures in the 15th century among the Cambridgeshire possessions of the Alingtons, the descendants of the Argentines (Chan. Inq. p.m. 38 & 39 Hen. VI, no. 42).

⁸⁵ *Rot. Lit. Pat.* (Rec. Com.), 96.

⁸⁶ *Cal. Rot. Chart.* 1199-1216 (Rec. Com.), 189b.

⁸⁷ *Inspeximus* July 1371 (Pat. 45 Edw. III, pt. ii, m. 32).

⁸⁸ *Cal. Close*, 1354-60, p. 587.

⁸⁹ *Cal. Close*, 1354-60, p. 587.

⁹⁰ Cott. MS. Nero, D 1, fol. 193. Charter of foundation and charter granting the lepers the land on which their houses were built free from all interference.

⁹¹ Abbot Roger in 1287 confirmed to the lepers all that they then held of Geoffrey's endowment (*ibid.* fol. 193 d.).

⁹² Abbot Richard de Wallingford withdrew this rent for two years, but after inspecting the brothers' charters paid it and confirmed it to them in 1329 (*ibid.*).

⁹³ Probably 'Henammesteda' of Domesday, now represented by Park and Tyttenhanger (see *V.C.H. Herts.* ii, 319).

⁹⁴ Cott. MS. Nero, D 1, fol. 193.

⁹⁵ *Ibid.*

⁹⁶ *Pipe R.* 6-14 Hen. II (Pipe R. Soc.), *passim*; Hunter, *Great Roll of the Pipe 1 Ric. I* (Rec. Com.), 20; *Close*, 2 Hen. III, m. 13; Rental of St. Julians, 1506 (Cott. MS. Claud. D 1, fol. 169).

RELIGIOUS HOUSES

The brothers received two papal bulls,⁹⁷ that of Pope Gregory⁹⁸ extending the protection of St. Peter to them and their goods and confirming the gifts of Abbot Geoffrey, the King of England and others; that of Pope Innocent⁹⁹ granting papal protection and confirmation and forbidding tithes to be taken of their orchards, woods and animals.

The perpetual right which the Perots claimed to place a leper in the hospital was disputed in 1278. The master refused to admit Ralph Perot's nominee, and a suit was consequently brought against him.¹⁰⁰ However, in the end Abbot Roger came to terms with Ralph and settled the difficulty.¹

No light is thrown upon the working of the hospital until the 14th century, but in 1305 it had as master a certain papal chaplain, Reginald of St. Albans,² who held three churches and three prebends, so that it is hardly likely that the lepers received much of his attention.

The events recorded in an undated petition of the lepers to the king³ occurred probably in the reign of Edward II.⁴ It states that the abbot while on a visitation had demanded the keys of the common chest and view of the lepers' own goods. On their demurring he had them turned out of their house, and had broken the locks and carried off their private property to the value of £60 and more, the greater part of which belonged to two brothers, Walter and Hugh de Aylesbury; he had moreover broken open the common chest and taken away their charters and privileges. They therefore begged the king to appoint persons to inquire into these and other matters which they would then disclose. The confiscation of the money seems sheer robbery, but it is not easy to arrive at the truth in these cases. The brothers resented, and probably resisted the visitation itself, as contrary to their rights,⁵

⁹⁷ Cott. MS. Nero, D i, fol. 193.

⁹⁸ Probably Gregory IX, and in that case the bull was issued in 1228.

⁹⁹ It is dated 4 May, sixth year of his pontificate, and may have been granted by Innocent II in 1135-6, Innocent III in 1203-4, or Innocent IV in 1249.

¹⁰⁰ Assize R. 323, m. 31 (6 Edw. I).

¹ *Gesta Abbat.* (Rolls Ser.), i, 480.

² *Cal. of Papal Letters*, ii, 1.

³ Anct. Pet. (P.R.O.), no. 7075, file 142.

⁴ At the end of the reign of Edward I there was a royal official called Walter de Aylesbury (*Cal. Close*, 1302-7, pp. 67, 404, 484), and although there is nothing actually to connect him with the leper of that name, the latter and his brother were very well provided with money and were apparently the most important inmates of the hospital, for only one other of the six is mentioned. Besides extortion from dependent houses was characteristic of Hugh de Eversden, Abbot of St. Albans 1309-27.

⁵ They considered it a contravention of Geoffrey's charter (see above).

and in this were quite wrong. The constitutions made by Abbot Michael in 1344⁶ show that discipline was lacking there, and the author of the *Gesta Abbatum*⁷ says plainly that the lepers had hitherto had more freedom than was good for them or the reputation of the hospital. These regulations, after stating that there were often fewer lepers⁸ than could be supported on the hospital property,⁹ provided that in future there should be six lepers there who were to be admitted by the abbot or his archdeacon; preference was to be given to monks of St. Albans or persons born within the abbey's jurisdiction, and married men were not to be received except under certain conditions.¹⁰ Their dress of russet colour was to consist of a tunic with sleeves which were to extend to the hand and were not to be stitched up or buttoned, a super-tunic closed to the ankles with sleeves covering the elbows, and a cowl; when they went to church they were to wear black cloaks with hoods as of old; they were to have large boots and might wear hose. At a suitable hour, not very early because of their ill-health, a bell was to be rung, and they were to go to the chapel to hear hours and mass said by the rector, called the chaplain of the lepers; afterwards they must go straight back to the hospital. They were forbidden to loiter on the high road between the church and the house, or to pass the bounds of the hospital except by leave of the master, who must never allow them to go to the town of St. Albans, to stay away the night, or to enter a brewery, bakehouse or grange.¹¹ No women were to enter the hospital but the washerwoman on her business or near relations of the brothers visiting them in sickness, and then only in daylight. When a leper was received as brother he was to make an inventory of the goods he brought with him, one-third of which he might bequeath by will to servants of the place or meritorious persons; the rest at his death went to the community. By old custom each leper was allowed 7 loaves a week, 5 white and 2 brown, 14 flagons of ale or 8*d.*; on certain feasts¹² a loaf, a measure of ale or 1*d.*, and $\frac{1}{2}$ *d.* in money; at Christmas

⁶ Cott. MS. Claud. E iv, fol. 371-4 d.

⁷ Vol. ii, 315.

⁸ Generally not more than three, sometimes only one.

⁹ In 1254, according to Matthew Paris (*Chron. Maj.* [Rolls Ser.], v, 452), the revenues had barely sufficed for the lepers' maintenance.

¹⁰ The wife must also adopt a religious life, so that the husband was freed from the marriage tie.

¹¹ A sanitary precaution for the protection of others.

¹² All Saints, St. Julian, the Purification of the Blessed Virgin Mary, the Annunciation, Trinity, St. Alban, St. John Baptist, Assumption and Nativity of the Virgin.

A HISTORY OF HERTFORDSHIRE

40 flagons of good ale or 40*d.*; at Martinmas a pig from the store or money; and during the year a quarter of oats, a bushel of beans, another of peas and 2 bushels of salt or the current price, 14*s.* for firing, 4*s.* for clothing, an occasional penny for a pittance and a share of the king's gift of 30*s.* 5*d.*¹³ Instead of the one priest¹⁴ there were to be five, and more if the income of the place increased; they must be men of good character¹⁵ and were to be examined by the archdeacon and admitted by him or the abbot. Their dress, like that of the priests of Pré, was to be a tunic, long-sleeved super-tunic closed to the ankles, tabard and hood, all of black,¹⁶ and each was to have a mark a year for clothing, the master 2 marks. They were to have meals together,¹⁷ and were to live and sleep in pairs until a common dormitory could be made. Services¹⁸ were to begin at dawn, the priest of the week¹⁹ saying the hours and another brother the mass of the Blessed Virgin Mary; then were to come the services for the lepers, to be followed by the mass of the day said by the priest of the week; all the inmates were to attend vespers and compline; arrangements were made for festivals, and for prayers for the benefactors of St. Albans and St. Julian's. The master, who was to be chosen from the chaplains by the abbot and if unsatisfactory was removable by him, was empowered to correct small faults, but correction otherwise was to be left to the abbot. Chapters were to be held twice a week; and pensions and corrodies²⁰ were never to be granted on any pretext whatever.

¹³ The rest of the hospital income was to be applied to the maintenance of the master and chaplains.

¹⁴ Certain tithes in the parishes of St. Michael and St. Stephen were allotted to him from the foundation (Cott. MS. Nero, D i, fol. 193).

¹⁵ Natives of the districts ruled by the abbot to be preferred to others.

¹⁶ They were to wear boots or low shoes with black or brown hose, but were not to be shod in any colour they pleased.

¹⁷ In illness food was to be taken to them and money given for medicine and special diet.

¹⁸ Abbot Michael gave beautiful books to the hospital both for divine service and secular use (*Gesta Abbat.* ii, 315).

¹⁹ A table of services and those to celebrate them was to be made, so that all should take their turn in order.

²⁰ The king often provided for old servants by quartering them on religious houses. In 1318 Edward II requested the same provision to be made for Simon Plane at St. Julian's as John Giffard lately had (*Cal. Close*, 1318-23, p. 116). Edward III in May 1327 asked the abbot to admit a servant of his who was smitten with leprosy (*ibid.* 1327-30, p. 199), but when this man died another who was probably not a leper was sent to replace him (*ibid.* 1339-41, p. 461).

In 1342 an attack had been made on the property of the hospital at Park and Tyttenhanger, and the common seal, deeds and other muniments stolen,²¹ and usurpations of its possessions, attributed by Abbot Michael partly to the carelessness of the brothers, were apparently not unusual. Edward III made them the reason for appointing a commission of inquiry in 1355, on the ground that there had been in consequence a decrease in the number of lepers in the house, and therefore of prayers for his ancestors, who he assumed were founders.²² The result is not known, but it is unlikely that Thomas de la Mare, then Abbot of St. Albans, acquiesced in this encroachment on his rights.

This abbot interested himself personally in St. Julian's, acting as confessor to the lepers in spite of the physical unpleasantness of the task.²³ He also made rules for the place.²⁴ After a preamble stating that the hospital was founded and maintained by the Abbot and convent of St. Albans, and that to the abbot therefore belonged the control of spiritual and temporal things there, he insisted on the rule as to clothes being kept; the lepers must wear high boots with three or four lacings, and low shoes were prohibited; those who wished to become brothers were to be on probation that their ways and speech might be under observation; the brothers were to love God and show mutual charity; in church they were to sit in the order in which they entered the hospital and not to presume through pride to take another's place, and silence must be observed during service; loitering near the high road was forbidden; none was to pass the bounds of old established; only the brother to whom such charge was committed was to enter the brewery or bake-house, and he was never to go near the bread and ale, since it was not fitting that men with their disease should touch things destined for the common use of men; the doors towards the garden were to be kept well closed to prevent scandals and other evils that might arise from free entrance, and brothers were not to go out without special leave; a brother passing the bounds should be punished by the withdrawal of his allowance, and anyone absenting himself a day and a night without leave of the abbot or archdeacon should be accounted a fugitive, and not enter again without the abbot's

²¹ *Cal. Pat.* 1340-3, p. 554.

²² *Ibid.* 1354-8, p. 330.

²³ *Gesta Abbat.* iii, 406.

²⁴ Cott. MS. Claud. E iv, fol. 375-6 d. In the form of oath to be taken by the rector or chaplain of the lepers the abbot's name instead of being represented by a letter is given as Thomas (fol. 376 d.). After Thomas de la Mare there is no Abbot Thomas until 1492, when the need for rules at St. Julian's was over.

RELIGIOUS HOUSES

permission; the regulation about women was again laid down with more emphasis²⁵; brothers who perpetually quarrelled and sowed discord were to have their allowances withdrawn; they might have private property,²⁶ but when they died or left the hospital it should belong to the house; no brother might make a will without the master's leave; seculars and probationers were to be excluded from chapters, and private chapters 'which might rather be called conspiracies' were forbidden. The points touched on were the same as before, but penalties for disobedience were more clearly defined, and the inference is that the rules had not been kept and greater severity was necessary.

The advowson of the chapel of St. Julian was given in 1353 to the master and brethren of the hospital, who had permission to appropriate the church²⁷; but in 1396 the rectory was made over to the chamber of the Prior of St. Albans²⁸ on the resignation of William Burcote, the rector, who was assigned a pension for life.²⁹ This may mean that the character of the place was changing, and the disturbances of the 15th century merely hastened the end of an institution already in decay. It was still called the Hospital of Priests and Lepers of St. Julian in 1470, when it was excused payment of the tenth on the score of poverty,³⁰ but the community probably survived only in the title.

Abbot William Albon by appointing Ralph Ferrers master for life in 1475³¹ caused considerable trouble to one of his successors. Ramryge, who became abbot in 1492, wanted to deprive him for dilapidating the property, and hoped to attain his object through a doctor of canon law named Robinson, who was to have the office if Ferrers could be removed.³² At some stage of the proceedings the abbot managed to get possession of Ferrers's letters of collation and sequestrated the revenues of the hospital.³³ But it was all useless. Although

Robinson was appointed,³⁴ he could not turn his rival out, and at last resigned his claim to the abbot.³⁵ When Ferrers died Ramryge granted the nomination to the king, but meanwhile Dr. Robinson gave the hospital for maintenance to Sir Robert Sheffield, knight, who put in his brother and five others to occupy it for him. The abbot at the king's request took measures to get rid of the interlopers and was thereupon accused of riot by the disappointed Dr. Robinson. It was probably the result of this affair that he obtained the king's licence on 7 May 1505 to annex the hospital or free chapel of St. Julian to St. Albans.³⁶

The property appears to have been worth then about £16 a year.³⁷

MASTERS OF THE HOSPITAL OF ST. JULIAN BY ST. ALBANS

Ilbert, occurs 1145³⁸

William³⁹

Nicholas, appointed in 1235⁴⁰

William Peytevin, occurs 1278⁴¹

Reginald de St. Albans, occurs December 1305⁴²

John de Lancaster, appointed 2 June 1349⁴³

John Trylle, occurs 3 December 1449⁴⁴

John Walter, appointed 10 January 1463-4⁴⁵

John Hankyn⁴⁶

Ralph Ferrers, LL.D., appointed 20 December 1475,⁴⁷ occurs 1500 or 1501⁴⁸

William Robinson, appointed in succession to Ferrers⁴⁹

³⁴ Robinson as master of St. Julian's in 1500 or 1501 was trying to recover the muniments from Ralph, whom he called the late incumbent, and Edward Ferrers (*ibid.* bdl. 245, no. 20).

³⁵ Star Chamb. Proc. Hen. VIII, bdl. 34, no. 26.

³⁶ Pat. 20 Hen. VII, pt. iii, m. 18.

³⁷ £15 7s. 11d., but this did not include the tithes in the parishes of St. Stephen and St. Michael, which were let with the hospital and cemetery in 1506. Rental of St. Julian's (Cott. MS. Claud. D i, fol. 169).

³⁸ Cott. Chart. xi, 6, 8.

³⁹ He was the son of a citizen of Rochelle hanged in 1224 for his fidelity to Henry III (Matthew Paris, *Chron. Maj.* [Rolls Ser.], iii, 84).

⁴⁰ By the king during a vacancy of the abbey (*ibid.* 386). ⁴¹ Assize R. 323, m. 24.

⁴² *Cal. of Papal Letters*, ii, 1.

⁴³ *Cal. Pat.* 1348-50, p. 330.

⁴⁴ *Herts. Gen. and Antiq.* iii, 278.

⁴⁵ Harl. MS. 602, fol. 73 d.

⁴⁶ Cott. MS. Nero, D vii, fol. 137. He is called master of St. Julian's when he was admitted to the fraternity of St. Albans, 6 June 1478, but this must be a mistake. ⁴⁷ *Reg. of St. Albans*, ii, 120.

⁴⁸ Early Chan. Proc. bdl. 245, no. 20. He is then called 'the late master,' but apparently was never actually removed.

⁴⁹ *Ibid.* He professed to be master in 1500 or 1501 (see above).

²⁵ The washerwoman was to be of mature age and good conduct and was to enter the brothers' houses only at certain hours. Women of bad repute were not to be allowed in the hospital. The brother who broke the rule as to female visitors, viz., with regard to the time of their departure, &c., was to be punished as if convicted of incontinency.

²⁶ The portion allotted to them in the hospital was recognized as insufficient for all their necessities.

²⁷ *Cal. Pat.* 1350-4, p. 481.

²⁸ *Ibid.* 1396-9, p. 24.

²⁹ *Gesta Abbat.* iii, 440-1.

³⁰ *Reg. of St. Albans*, ii, 86-8.

³¹ *Ibid.* 120.

³² Star Chamb. Proc. Hen. VIII, bdl. 34, no. 26.

³³ He asked to see the letters and then would not return them. See Ferrers's petition to the chancellor, c. 1493-1500 (Early Chan. Proc. bdl. 201, no. 30).

